



NS-P430/ NS-P436



(NS-P430/NS-P436: NX-430P + NX-C430 + YST-SW015)

*HOME CINEMA 5.1CH SPEAKER PACKAGE/
HOME CINEMA 6.1CH SPEAKER PACKAGE*

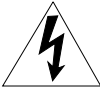

OWNER'S MANUAL

IMPORTANT SAFETY INSTRUCTIONS

	CAUTION RISK OF ELECTRIC SHOCK DO NOT OPEN	
CAUTION: TO REDUCE THE RISK OF ELECTRIC SHOCK, DO NOT REMOVE COVER (OR BACK). NO USER-SERVICEABLE PARTS INSIDE. REFER SERVICING TO QUALIFIED SERVICE PERSONNEL.		

• Explanation of Graphical Symbols

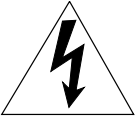

The lightning flash with arrowhead symbol, within an equilateral triangle, is intended to alert you to the presence of uninsulated "dangerous voltage" within the product's enclosure that may be of sufficient magnitude to constitute a risk of electric shock to persons.



The exclamation point within an equilateral triangle is intended to alert you to the presence of important operating and maintenance (servicing) instructions in the literature accompanying the appliance.

WARNING TO REDUCE THE RISK OF FIRE OR ELECTRIC SHOCK, DO NOT EXPOSE THIS APPLIANCE TO RAIN OR MOISTURE.

IMPORTANT Please record the serial number of this system in the space below. Model: Serial No.: The serial number is located on the rear of the main unit. Retain this Owner's Manual in a safe place for future reference.

- 1 Read these instructions.
- 2 Keep these instructions.
- 3 Heed all warnings.
- 4 Follow all instructions.
- 5 Do not use this apparatus near water.
- 6 Clean only with dry cloth.
- 7 Do not block any ventilation openings. Install in accordance with the manufacturer's instructions.
- 8 Do not install near any heat sources such as radiators, heat registers, stoves, or other apparatus (including amplifiers) that produce heat.
- 9 Do not defeat the safety purpose of the polarized or grounding-type plug. A polarized plug has two blades with one wider than the other. A grounding type plug has two blades and a third grounding prong. The wide blade or the third prong are provided for your safety. If the provided plug does not fit into your outlet, consult an electrician for replacement of the obsolete outlet.
- 10 Protect the power cord from being walked on or pinched particularly at plugs, convenience receptacles, and the point where they exit from the apparatus.
- 11 Only use attachments/accessories specified by the manufacturer.
- 12 Use only with the cart, stand, tripod, bracket, or table specified by the manufacturer, or sold with the apparatus. When a cart is used, use caution when moving the cart/ apparatus combination to avoid injury from tip-over. 
- 13 Unplug this apparatus during lightning storms or when unused for long periods of time.
- 14 Refer all servicing to qualified service personnel. Servicing is required when the apparatus has been damaged in any way, such as power-supply cord or plug is damaged, liquid has been spilled or objects have fallen into the apparatus, the apparatus has been exposed to rain or moisture, does not operate normally, or has been dropped.

- | |
|---|
| <ul style="list-style-type: none">• Be sure to allow spaces of at least 20 cm above, behind and on both sides of the unit.• Do not place the following objects on this unit:
A vessel with water in it.
If the vessel falls by vibrations and water spills, it may cause damage to the unit, and/or you may get an electric shock. |
|---|

FCC INFORMATION (for US customers only)

1. IMPORTANT NOTICE : DO NOT MODIFY THIS UNIT!

This product, when installed as indicated in the instructions contained in this manual, meets FCC requirements. Modifications not expressly approved by Yamaha may void your authority, granted by the FCC, to use the product.

2. IMPORTANT : When connecting this product to accessories and/or another product use only high quality shielded cables. Cable/s supplied with this product **MUST** be used. Follow all installation instructions. Failure to follow instructions could void your FCC authorization to use this product in the USA.

3. NOTE : This product has been tested and found to comply with the requirements listed in FCC Regulations, Part 15 for Class "B" digital devices. Compliance with these requirements provides a reasonable level of assurance that your use of this product in a residential environment will not result in harmful interference with other electronic devices.

This equipment generates/uses radio frequencies and, if not installed and used according to the instructions found in the users manual, may cause interference harmful to the operation of other electronic devices.

Compliance with FCC regulations does not guarantee that interference will not occur in all installations. If this product is found to be the source of interference, which can be determined by turning the unit "OFF" and "ON", please try to eliminate the problem by using one of the following measures:

Relocate either this product or the device that is being affected by the interference.

Utilize power outlets that are on different branch (circuit breaker or fuse) circuits or install AC line filter/s.

In the case of radio or TV interference, relocate/reorient the antenna. If the antenna lead-in is 300 ohm ribbon lead, change the lead-in to coaxial type cable.

If these corrective measures do not produce satisfactory results, please contact the local retailer authorized to distribute this type of product. If you can not locate the appropriate retailer, please contact Yamaha Electronics Corp., U.S.A. 6660 Orangethorpe Ave, Buena Park, CA 90620.

The above statements apply **ONLY** to those products distributed by Yamaha Corporation of America or its subsidiaries.

We Want You Listening For A Lifetime



YAMAHA and the Electronic Industries Association's Consumer Electronics Group want you to get the most out of your equipment by playing it at a safe level. One that lets the sound come through loud and clear without annoying blaring or distortion – and, most importantly, without affecting your sensitive hearing.

Since hearing damage from loud sounds is often undetectable until it is too late, YAMAHA and the Electronic Industries Association's Consumer Electronics Group recommend you to avoid prolonged exposure from excessive volume levels.

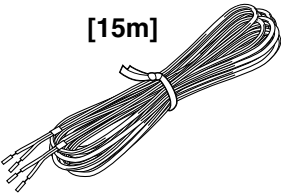
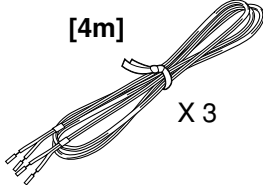

UNPACKING

Please check to make sure all listed items are included.

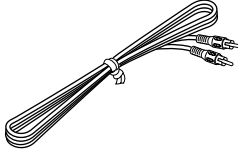
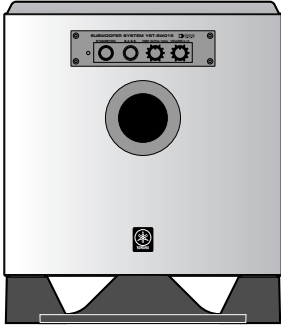
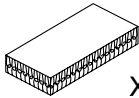
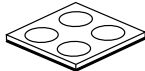
<p>Main and rear speakers (and rear center speaker for NS-P436)</p> <p>NX-430P</p>  <p><NS-P430> X 4</p> <p><NS-P436> X 5</p>	<p>Speaker cables</p> <p>[15m]</p>  <p><NS-P430> X 2</p> <p><NS-P436> X 3</p> <p>[4m]</p>  <p>X 3</p>
<p>Center speaker</p> <p>NX-C430</p> 	<p>Subwoofer cable</p> 
<p>Subwoofer</p> <p>YST-SW015</p> 	<p>Fasteners (for NX-C430)</p>  <p>X 2</p>
	<p>Nonskid pads (for YST-SW015)</p> 

For Canadian Customers
To prevent electric shock, match wide blade of plug to wide slot and fully insert.
This Class B digital apparatus complies with Canadian ICES-003.

For U.K. customers
If the socket outlets in the home are not suitable for the plug supplied with this appliance, it should be cut off and an appropriate 3 pin plug fitted. For details, refer to the instructions described below.
Note: The plug severed from the mains lead must be destroyed, as a plug with bared flexible cord is hazardous if engaged in a live socket outlet.

SPECIAL INSTRUCTIONS FOR U.K. MODEL

IMPORTANT:
THE WIRES IN MAINS LEAD ARE COLOURED IN ACCORDANCE WITH THE FOLLOWING CODE:
Blue: NEUTRAL
Brown: LIVE
As the colours of the wires in the mains lead of this apparatus may not correspond with the coloured markings identifying the terminals in your plug, proceed as follows:
The wire which is coloured BLUE must be connected to the terminal which is marked with the letter N or coloured BLACK. The wire which is coloured BROWN must be connected to the terminal which is marked with the letter L or coloured RED. Making sure that neither core is connected to the earth terminal of the three pin plug.

CAUTION: Read this before operating your unit.

- To assure the finest performance, please read this manual carefully. Keep it in a safe place for future reference.
- Install the speakers in a cool, dry, clean place – away from windows, heat sources, sources of excessive vibration, dust, moisture and cold. Avoid sources of humming (transformers, motors). To prevent fire or electric shock, do not expose the speakers to rain or water.
- To prevent the enclosure from warping or discoloring, do not place the speakers where they will be exposed to direct sunlight or excessive humidity.
- Avoid installing the speakers where foreign objects may fall onto them and/or where they may be exposed to liquid dripping or splashing.
Do not place the following objects on top of the speakers:
 - Other components, as they might cause damage and/or discoloration on the surface of the speakers.
 - Burning objects (i.e. candles), as they might cause fire, damage to the speakers and/or personal injury.
 - Containers with liquid in them, as they might cause electric shock to the user and/or damage to the speakers.
- Do not place the speakers where they are liable to be knocked over or struck by falling objects. Stable placement will also ensure better sound performance.
- Placing the speakers on the same shelf or rack as the turntable can result in feedback.
- Secure placement or installation is the owner's responsibility. YAMAHA shall not be liable for any accident caused by improper placement or installation of speakers.
- Any time you note distortion, reduce the volume control on your amplifier to a lower setting. Never allow your amplifier to be driven into "clipping". Otherwise the speakers may be damaged.
- When using an amplifier with a rated output power higher than the nominal input power of the speakers, care should be taken never to exceed the speakers' maximum input.
- Do not attempt to clean the speakers with chemical solvents as this might damage the finish. Use a clean, dry cloth.
- Do not attempt to modify or fix the speakers. Contact qualified YAMAHA service personnel when any service is needed. The cabinet should never be opened for any reason.
- Be sure to read the "TROUBLESHOOTING" section regarding common operating errors before concluding that the speakers are faulty.
- Do not cover the rear panel of this unit with a newspaper, a tablecloth, a curtain, etc. in order not to obstruct heat radiation. If the temperature inside this unit rises, it may cause fire, damage to this unit and/or personal injury.
- Do not plug in this unit to a wall outlet until all connections are completed.
- The voltage to be used must be the same as that specified on the rear panel. Using this unit with a higher voltage than specified is dangerous and may cause fire, damage to this unit, and/or personal injury. YAMAHA will not be held responsible for any damage resulting from use of this unit with a voltage other than specified.
- To prevent lightning damage, disconnect the AC power plug when there is an electric storm.
- Super-bass frequencies reproduced by this unit may cause a turntable to generate a howling sound. In such a case, move this unit away from the turntable.
- This unit may be damaged if certain sounds are continuously outputted at high volume level. For example, if 20 Hz–50 Hz sine waves from a test disc, bass sounds from electronic instruments, etc. are continuously outputted, or when the stylus of a turntable touches the surface of a disc, reduce the volume level to prevent this unit from being damaged.
- If you hear distorted noise (i.e. unnatural, intermittent "rapping" or "hammering" sounds) coming from this unit, reduce the volume level. Extremely loud playing of a movie soundtrack's low frequency, bass-heavy sounds or similarly loud popular music passages can damage this speaker system.
- Vibration generated by super-bass frequencies may distort images on a TV. In such a case, move this unit away from the TV set.
- When disconnecting the power cord from the wall outlet, grasp the plug; do not pull the cord.
- When not planning to use this unit for a long period (i.e. vacation, etc.), disconnect the AC power plug from the wall outlet.
- **VOLTAGE SELECTOR**
(For China, Korean and General models)
The voltage selector switch on the rear panel of this unit must be set for your local main voltage BEFORE plugging this unit into the AC main supply.
Voltages are 110-120/220-240 V AC, 50/60 Hz.

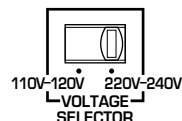

For YST-SW015

- Do not operate this unit upside down. It may overheat, possibly causing damage.
- Do not use excessive force on switches, controls or connection wires. When moving this unit, first disconnect the power plug and the wires connected to other equipments. Never pull the wires themselves.
- Since this unit has a built-in power amplifier, heat will radiate from the rear panel. Place the unit apart from the walls, allowing spaces of at least 20 cm above, behind and on both sides of the unit to prevent fire or damage. Furthermore, do not position with the rear panel facing down on the floor or other surfaces.
- When using a humidifier, be sure to avoid condensation inside this unit by allowing enough spaces around this unit or avoiding excess humidification. Condensation might cause a fire, damage to this unit, and/or electric shock.

Standby mode

If the POWER switch is set to the ON position and the AUTO STANDBY switch is set to the HIGH or LOW position, this unit turns into the standby mode when no signal is received by this unit for 7 to 8 minutes.
In this state, this unit is designed to consume a very small quantity of power.

WARNING

TO REDUCE THE RISK OF FIRE OR ELECTRIC SHOCK, DO NOT EXPOSE THIS UNIT TO RAIN OR MOISTURE.

COMPONENTS OF THE PACKAGE

The speaker package “NS-P430 and NS-P436” is designed for use in a multi-channel audio system such as a home theater system.

NS-P430 includes four NX-430P speaker systems, one NX-C430 speaker system and one YST-SW015 subwoofer system.

NS-P436 includes five NX-430P speaker systems, one NX-C430 speaker system and one YST-SW015 subwoofer system.

<NX-430P>

2-way acoustic-suspension speaker system used for the main and rear speakers (and rear center speaker for NS-P436)

<NX-C430>

2-way acoustic-suspension speaker system used for the center speaker

<YST-SW015>

Active Servo Processing Subwoofer System with a built-in power amplifier

- This subwoofer system employs Advanced Yamaha Active Servo Technology which YAMAHA has developed for reproducing higher quality super-bass sound. (Refer to page 14 for details on Advanced Yamaha Active Servo Technology.) This super-bass sound adds a more realistic, theater-in-the-home effect to your stereo system.
- The HIGH CUT control enables you to adjust the tone balance between the subwoofer and the main speakers.
- The Automatic power-switching function saves you the trouble of pressing the STANDBY/ON button to turn the power on or turn it to the STANDBY mode.

QD·Bass
TECHNOLOGY

QD-Bass Technology

QD-Bass (Quatre Dispersion Bass) technology uses square, pyramid-shaped reflective plates to radiate the sound in four horizontal directions.

CONTENTS

IMPORTANT SAFETY INSTRUCTIONS	II	CONNECTIONS	7
UNPACKING	IV	An example of basic connections	7
CAUTION	1	How to connect speaker cables to the input and output terminals of the speakers	9
COMPONENTS OF THE PACKAGE	2	USING THE SUBWOOFER (YST-SW015) ...	10
SETTING UP THE SPEAKERS	3	Controls and their functions	10
Placing the subwoofer	4	Automatic power-switching function	11
Placing the center speaker	4	Adjusting the subwoofer before use	12
Mounting the main/rear/center speakers (and rear center speaker for NS-P436) on a wall	5	Frequency characteristics	13
Mounting the main/rear speakers (and rear center speaker for NS-P436) by using commercially available speaker stands or brackets	6	ADVANCED YAMAHA ACTIVE SERVO TECHNOLOGY (for YST-SW015)	14
		TROUBLESHOOTING	15
		SPECIFICATIONS	Back Cover

■ About this manual

- This manual is printed prior to production. Design and specifications are subject to change in part for the reason of the improvement in operativity ability, and others. In this case, the product has priority.
- Some of the illustrations and names of the package contents etc. written in this manual may differ from the actual products and the names written on the package etc.

SETTING UP THE SPEAKERS

Before making connections, place all speakers in their respective positions. The positioning of the speakers is important because it controls the whole sound quality of this system.

Place the speakers depending on your listening position by following the instructions below.

Speaker configuration

<NS-P430>

This speaker package employs a 6 speaker configuration: 2 main speakers, 2 rear speakers, a center speaker and a subwoofer.

The main speakers emit main source sound. The rear speakers emit surround sounds, and the center speaker emits center sounds (dialog etc.). The subwoofer emits reinforcing low frequencies on your audio system.

<NS-P436>

This speaker package employs a 7 speaker configuration: 2 main speakers, 2 rear speakers, a center speaker, a rear center speaker and a subwoofer.

The main speakers emit main source sound. The rear and rear center speakers emit surround sounds, and the center speaker emits center sounds (dialog etc.). The subwoofer emits reinforcing low frequencies on your audio system.

Note

In this speaker package, the same speakers (NX-430P) are used for the main and rear speakers (and rear center speaker for NS-P436).

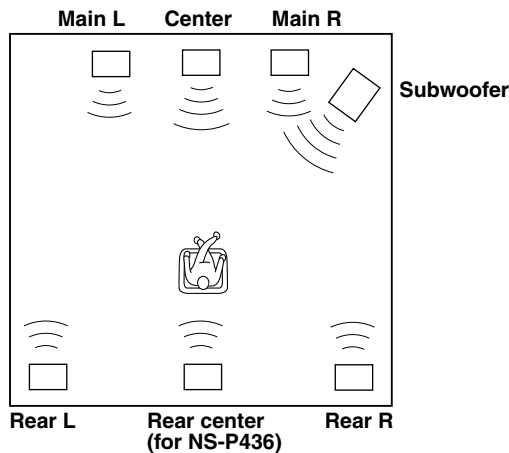

Placing speakers

Main speakers: On both sides of and at approximately the same height as the TV set.

Rear speakers: Behind your listening position, facing slightly inward. About 1.8 m (approx. 6 feet) from the floor.

Center speaker: Precisely between the main speakers.

Rear center speaker (for NS-P436):

Precisely between the rear speakers.

Subwoofer:

The position of the subwoofer is not so critical because low bass tones are not highly directional.

Refer to "Placing the subwoofer" on page 4 for a recommended positioning of the subwoofer.

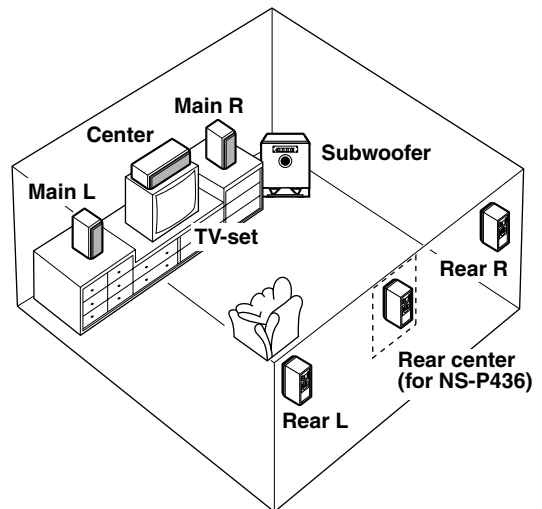

These speakers feature a magnetically shielded design, but there is still a chance that placing them too close to a TV set might impair picture color. Should this happen, move the speakers away from the TV set.

■ Placing the subwoofer

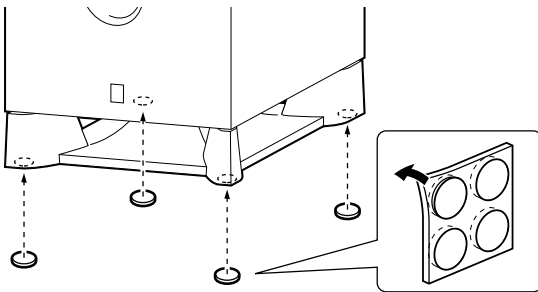
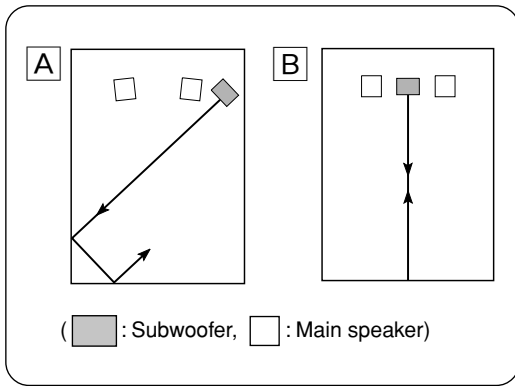

It is recommended to place the subwoofer on the outside of either the right or the left main speaker. (See fig. [A].) The placement shown in fig. [B] is also possible, however, if the subwoofer system is placed directly facing the wall, the bass effect may die because the sound from it and the sound reflected by the wall may cancel out each other. To prevent this from happening, face the subwoofer system at an angle as shown in fig. [A].

Note

There may be a case that you cannot obtain enough super-bass sounds from the subwoofer when listening in the center of the room. This is because “standing waves” have been developed between two parallel walls and they cancel the bass sounds.

In such a case, face the subwoofer obliquely to the wall. It also may be necessary to break up the parallel surfaces by placing bookshelves etc. along the walls.

Use the nonskid pads

Put the provided nonskid pads at the four corners on the bottom of the subwoofer to prevent the subwoofer from moving by vibrations etc.

■ Placing the center speaker

You can place the speaker on top of the TV if the top is flat, on the floor under the TV, or inside the TV rack. Be sure to place the speaker in a stable position.

When placing the speaker on top of the TV, to prevent the speaker from falling, attach the provided fasteners at two points on the bottom of the speaker and on the top of the TV.

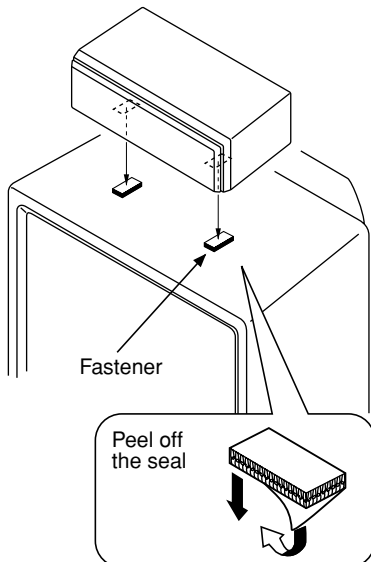

Notes

- Do not place the speaker on top of a TV whose area is smaller than the bottom of the speaker. If placed, the speaker may fall and cause injury.
- Do not place the speaker on top of a TV if the top is inclined.
- Do not touch the adhesive surface after peeling off the seal as this will weaken its adhesive strength.
- Thoroughly wipe clean the surface where the fastener is to be applied. Note that adhesive strength is weakened if the surface is dirty, oily or wet and that this may cause the center speaker to fall.

■ Mounting the main/rear/center speakers (and rear center speaker for NS-P436) on the wall

1 Tapping screw
(Available at the hardware store)

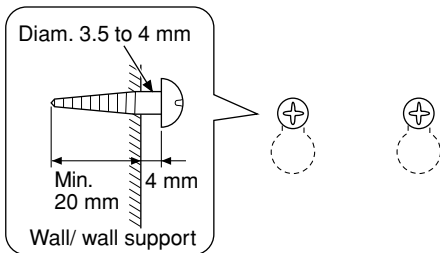

2

Main/rear/rear center (for NS-P436)

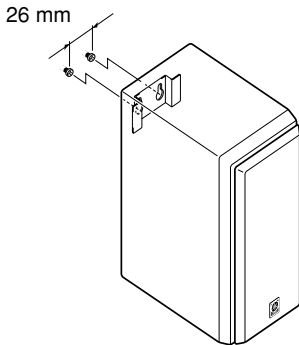

Center

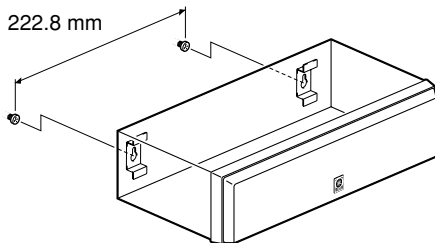

You can mount the main, rear and/or center speakers (and/or rear center speaker for NS-P436) on a wall. To mount the speakers on a wall, use the holes of the brackets attached on the speakers' back panels.

Main/rear/rear center (for NS-P436)

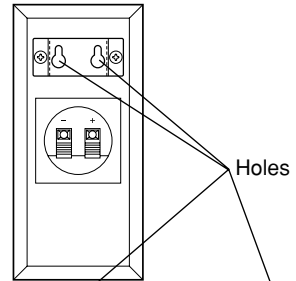

Center

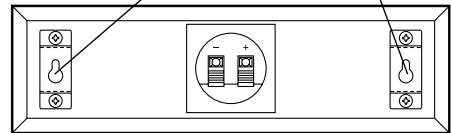

- 1** Fasten two screws into a firm wall or wall support at the interval shown below.

Main/rear/rear center (for NS-P436) 26 mm (1")
Center 222.8 mm (8-3/4")
- 2** Hang the speaker by mounting the holes on the protruding screws.
 - * Make sure that the screws are securely affixed by the narrow parts of the holes.

WARNING

- Each speaker weighs as follows.

Main/rear/rear center (for NS-P436) 1.2 kg (2 lbs. 10 oz.)
Center 1.7 kg (3 lbs. 12 oz.)
- Do not mount them on thin plywood or a wall composed of a soft surface material. If mounted, the screws may pull out of the flimsy surface and the speakers may fall. This may damage the speakers or cause personal injury.
- Do not affix the speakers to a wall using nails, adhesives, or any other unstable hardware. Long-term use and vibrations may cause the speakers to fall.
- To avoid accidents resulting from tripping over loose speaker cables, fix the cables to the wall.
- Select an appropriate position on the wall to mount the speaker so that no one will injure his/her head or face.

■ Mounting the main/rear speakers (and rear center speaker for NS-P436) by using commercially available speaker stands or brackets

You can also use the screw holes on the bottom of the speaker for installing the speakers on commercially available speaker stands (if you do not use the attached mounting brackets.)

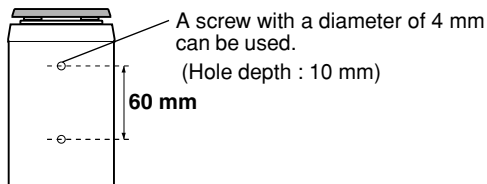

Using the Yamaha Speaker Stand SPS-10MM (option)

By using the Yamaha Speaker Stand SPS-10MM, speakers can be placed on the floor. (Two stands make a set.)

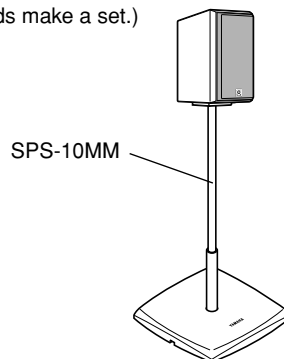

* The SPS-10MM is not available in some areas.

Removing the front cover

Main/rear/rear center (for NS-P436)

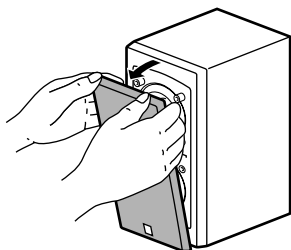

Center

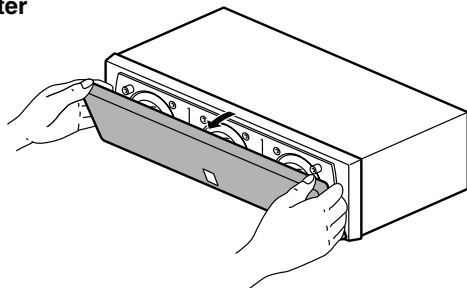

The front cover is fastened to the enclosure at four points and can be removed if desired. To remove the cover, hold on to both sides and slowly pull straight away from the speaker. To reattach, line up the four holes on the inner surface of the cover with the four corresponding pegs on the speaker and push gently.

Note

When the cover is removed, be sure not to touch the speaker units with your hands or to exert excessive force with tools.

CONNECTIONS

Caution: Plug in the subwoofer and other audio/video components after all connections are completed.

■ An example of basic connections

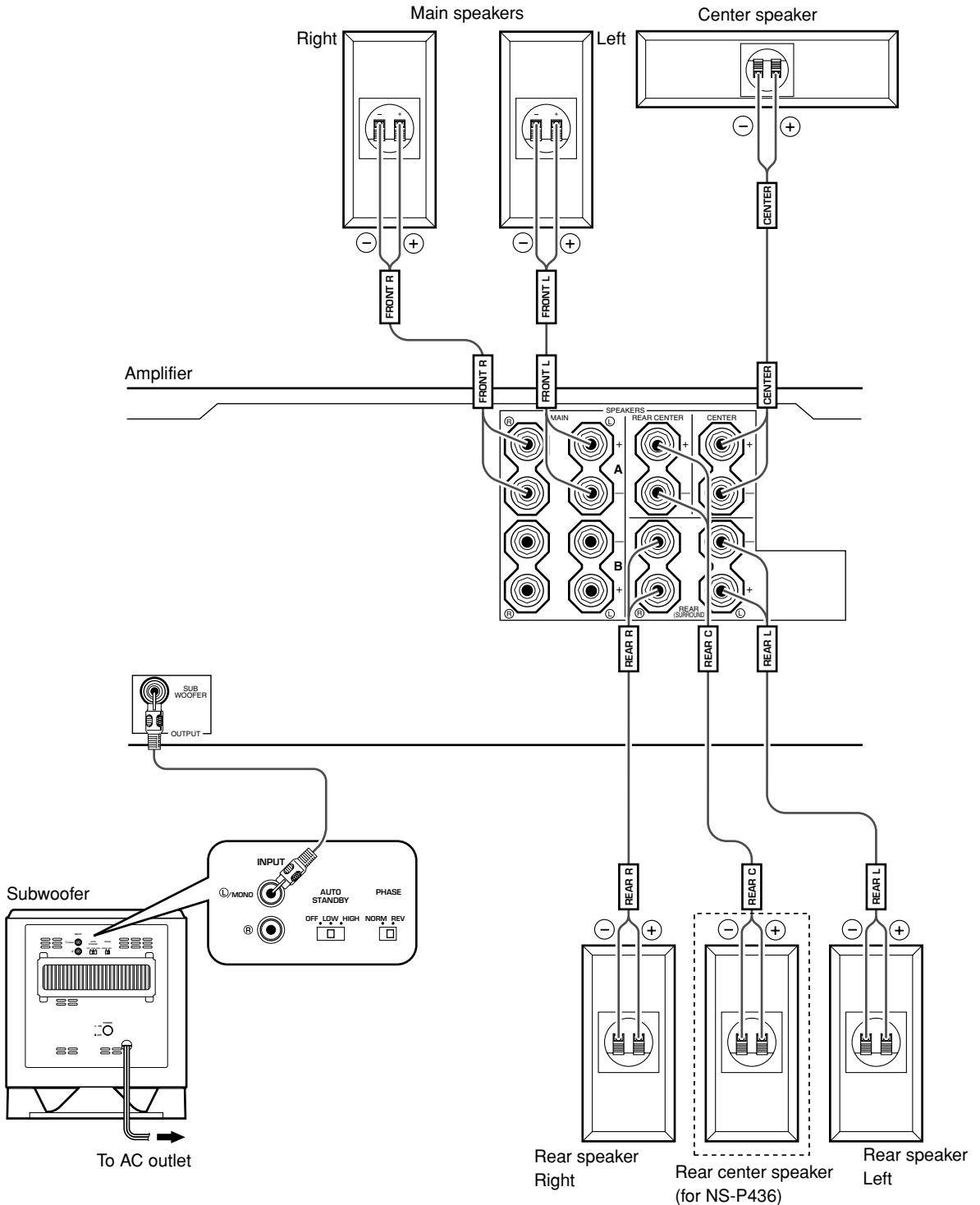

- Connect the main, center and rear speakers (and rear center speaker for NS-P436) to the speaker output terminals of your amplifier with the provided speaker cables.
 - * The provided speaker cables have labels marked FRONT L, FRONT R, CENTER, REAR L, REAR R (and REAR C for NS-P436). Connect each speaker cable to the corresponding speaker by following the figure on page 7.

(The speaker cables marked FRONT L/R are used for connecting the main speakers to the MAIN speakers' terminals on the amplifier.)
 - * Connect each speaker making sure not to reverse the polarity (+, -). If the speaker is connected with reversed polarity, the sound will be unnatural and lack bass.
 - * For the main and rear speakers only, connect one speaker to the left (marked L) terminals of your amplifier, and another speaker to the right (marked R) terminals.

- Connect the subwoofer to the line output (pin jack) terminal(s) of the amplifier.
 - * To connect with a YAMAHA DSP amplifier (or AV receiver), connect the SUBWOOFER (or LOW PASS etc.) terminal on the rear of the DSP amplifier (or AV receiver) to the L /MONO INPUT terminal of the subwoofer.
 - * To connect the subwoofer to the SPLIT SUBWOOFER terminals on the rear of the DSP amplifier, connect them to both the left L /MONO and right R INPUT terminals of the subwoofer.

Note

When connecting to a monaural line output terminal of the amplifier, connect to the L /MONO INPUT terminal.

■ How to connect speaker cables to the input terminals of the speakers

For connections, keep the speaker cables as short as possible. Do not bundle or roll up the excess part of the cables. If the connections are faulty, no sound will be heard from the speakers.

Main speakers

Center speaker

Use the provided speaker cables (4 m). One side of the speaker cable is red and the other side is black. Connect the (+) terminals on both the speaker and the amplifier using the red side of the cable. Connect the (-) terminals on both components using the black side.

Red: positive (+)
Black: negative (-)

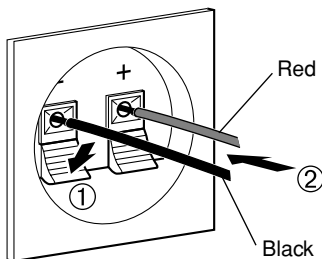

Before connecting

Remove the insulation coating at the extremity of each speaker cable by twisting the coating off.

Good **No Good**



How to Connect:

- ① Press and hold the terminal's tab, as shown in the figure.
- ② Insert the bare wire.
- ③ Release your finger from the tab to allow it to lock securely on the cable's wire end.
- ④ Test the firmness of the connection by pulling lightly on the cable at the terminal.

Note

Do not let the bare speaker wires touch each other as this could damage the speaker or the amplifier, or both of them.

Rear speakers

Rear center speaker (for NS-P436)

Use the provided speaker cables (15 m). One side of the speaker cable has a gray line and the other side has no line. Connect the (+) terminals on both the speaker and the amplifier using the side with a gray line. Connect the (-) terminals on both components using the side with no line.

Red: positive (+)
Black: negative (-)

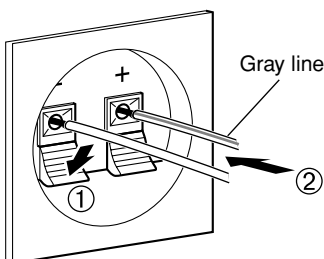

USING THE SUBWOOFER (YST-SW015)

■ Controls and their functions

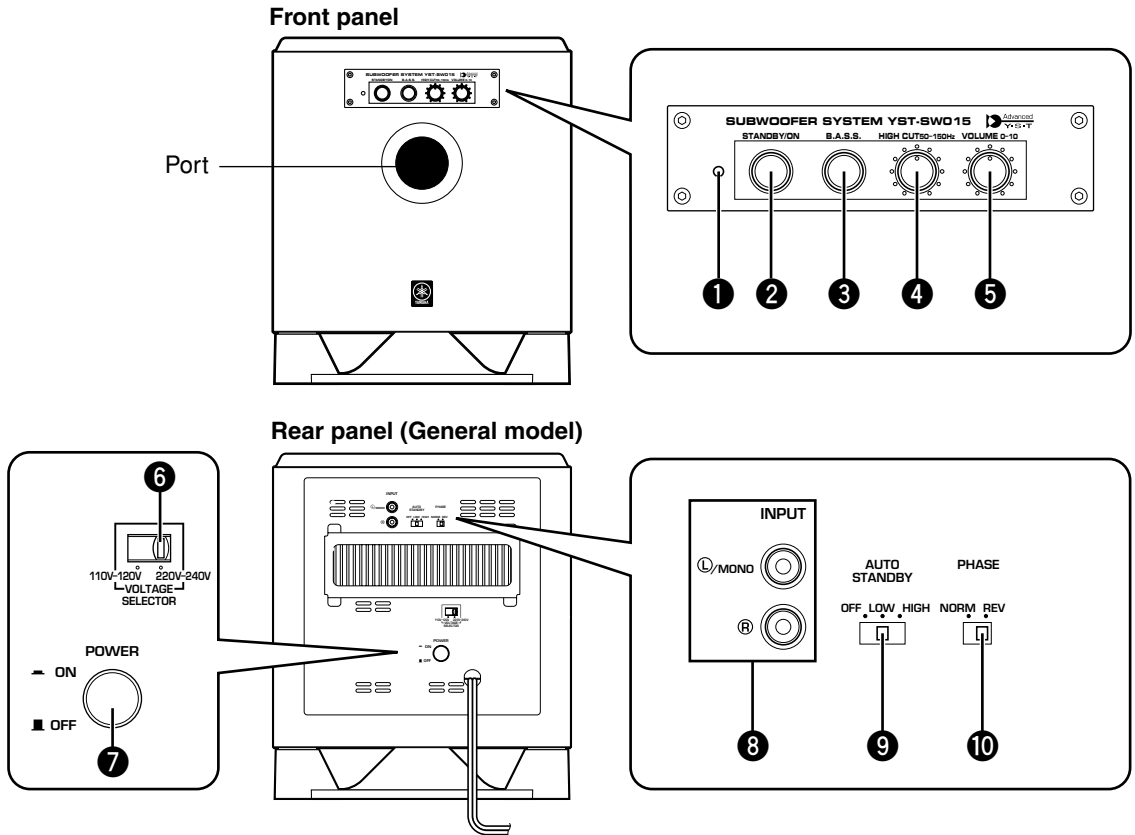

1 **Power indicator**
Lights up in green while the subwoofer is on.
Lights up in red while the subwoofer is set in the standby mode by the operation of the automatic power-switching function.
Goes off when the subwoofer is set in the standby mode.

2 **STANDBY/ON button**
Press this button to turn on the power when the **POWER (7)** switch is set in the ON position. (The power indicator lights up in green.)
Press again to set the subwoofer in the standby mode. (The power indicator goes off.)

Standby mode

The subwoofer is still using a small amount of power in this mode.

3 **B.A.S.S. (Bass Action Selector System) button**
When this button is pressed in to the MUSIC position, the bass sound in audio software is well reproduced.
By pressing the button again so that it pops out at the MOVIE position, the bass sound in video software is well reproduced.



4 **HIGH CUT control**
Adjusts the high frequency cut off point.
Frequencies higher than the frequency selected by this control are all cut off (and no output).
* One graduation of this control represents 10 Hz.

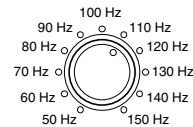

5 **VOLUME control**
Adjusts the volume level. Turn the control clockwise to increase the volume, and counterclockwise to decrease the volume.

6 **VOLTAGE SELECTOR switch**
(For China, Korean and General models)
If the preset setting of the switch is incorrect, set the switch to the proper voltage range (220V-240V or 110V-120V) of your area.
Consult your dealer if you are unsure of the correct setting.

WARNING

Be sure to unplug the subwoofer before setting the VOLTAGE SELECTOR switch correctly.

- 7 POWER** switch
Normally, set this switch to the ON position to use the subwoofer. In this state, you can turn on the subwoofer or turn the subwoofer into the standby mode by pressing the **STANDBY/ON** (2) button. Set this switch to the OFF position to completely cut off the subwoofer's power supply from the AC line.
- 8 INPUT** terminals
Used to input line level signals from the amplifier.
(Refer to "**CONNECTIONS**" for details.)
- 9 AUTO STANDBY (HIGH/LOW/OFF)** switch
This switch is originally set to the OFF position. By setting this switch to the HIGH or LOW position, the subwoofer's automatic power-switching function operates as described below. If you do not need this function, leave this switch in the OFF position.
* Make sure to change the setting of this switch only when the subwoofer is set in the standby mode by pressing the **STANDBY/ON** (2) button.
- 10 PHASE** switch
Normally this switch is to be set to the REV (reverse) position. However, according to the listening condition or your preference, there may be a case when better sound quality is obtained by setting this switch to the NORM (normal) position. Select the better position by monitoring the sound.

■ Automatic power-switching function

If the source being played is stopped and the input signal is cut off for 7 to 8 minutes, the subwoofer automatically switches to the standby mode. (When the subwoofer switches to the standby mode by the automatic power-switching function, the power indicator lights up in red.) When you play a source again, the power of the subwoofer turns on automatically by sensing audio signals input to the subwoofer.

This function operates by sensing a certain level of low frequency input signal. Usually set the **AUTO STANDBY** switch to the LOW position. However, if this function does not operate smoothly, set the switch to the HIGH position. In the HIGH position, the power will turn on even with a low level of input signal. But please be aware that the subwoofer may not switch to the standby mode when there is an extremely low input signal.

- * The power might turn on unexpectedly by sensing noise from other appliances. If that occurs, set the **AUTO STANDBY** switch to the OFF position and use the **STANDBY/ON** button to switch the power between on and in the standby mode manually.
- * This function detects the low-frequency components below 200 Hz of the input signals (i.e., the explosion in the action movie, the sound of the bass guitar or the bass drum, etc.).
- * The minutes required to switch the subwoofer to the standby mode might change by sensing noise from other appliances.

This function is available only when the power of the subwoofer is on (by pressing the STANDBY/ON button).

■ Adjusting the subwoofer before use

Before using the subwoofer, adjust the subwoofer to obtain the optimum volume and tone balance between the subwoofer and the main speakers by following the procedures described below.

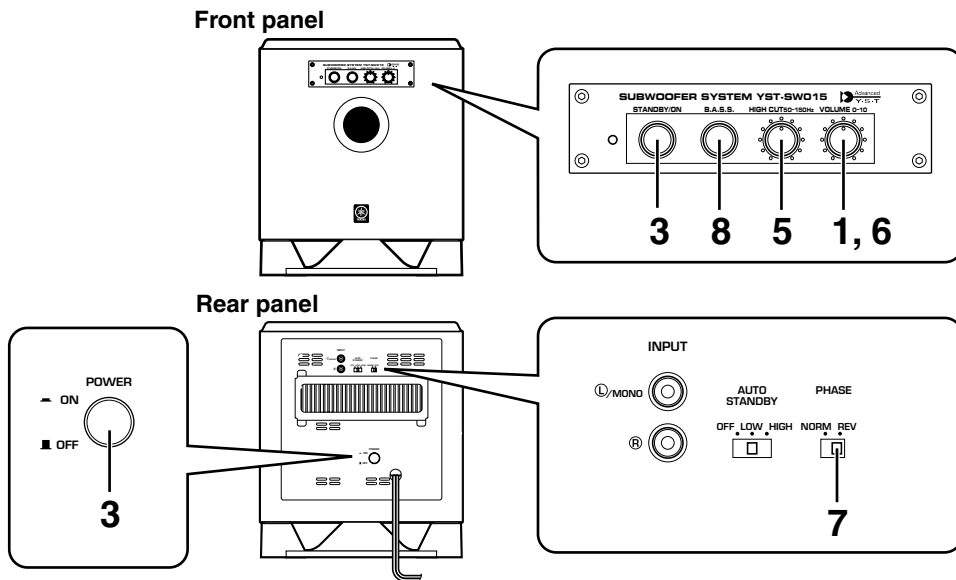

1 Set the **VOLUME** control to minimum (0).

2 Turn on the power of all the other components.

3 Make sure that the **POWER** switch is set to the ON position, then press the **STANDBY/ON** button to turn on the subwoofer.

* The Power indicator lights up in green.

4 Play a source containing low-frequency components and adjust the amplifier's volume control to the desired listening level.

5 Adjust the **HIGH CUT** control to the position where the desired response can be obtained.

This system is designed so that the optimum tone balance between the subwoofer and the main speakers (NX-430P) is obtained when this control is set at 110 Hz. However, the tone balance may change depending on the room size, the distance from the subwoofer to the main speakers, etc. So, if you prefer, turn the **HIGH CUT** control and set it to a position where a better tone balance is obtained.

6 Increase the volume gradually to adjust the volume balance between the subwoofer and the main speakers.

7 Set the **PHASE** switch to the position which gives you the better bass sound.

Normally, set the switch to the REV (reverse) position. If the desired response cannot be obtained, set the switch to the NORM (normal) position.

8 Select "MOVIE" or "MUSIC" according to the played source.

MOVIE: When a movie type source is played, the low-frequency effects are enhanced to allow the listener enjoy more powerful sound. (The sound will be thicker and deeper.)

MUSIC: When an ordinary music source is played, the excessive low-frequency components are cut off to make the sound clearer. (The sound will be lighter and reproduces the melody line more clearly.)

- **Once the volume balance between the subwoofer and the main speakers is adjusted, you can adjust the volume of your whole sound system by using the amplifier's volume control.**

However, if you change the main speakers NX-430P to others, you must make this adjustment again.

- **For adjusting the VOLUME control, the HIGH CUT control and the PHASE switch, refer to "Frequency characteristics" on the next page.**

■ Frequency characteristics

Adjustment of the **VOLUME** control, the **HIGH CUT** control and the **PHASE** switch should be changed depending on the room size, the distance from the subwoofer to the main speakers, sources, etc.

Following figures show the optimum adjustment of each control and the frequency characteristics when this subwoofer is combined with NX-430P.

Frequency characteristics of this subwoofer (YST-SW015)

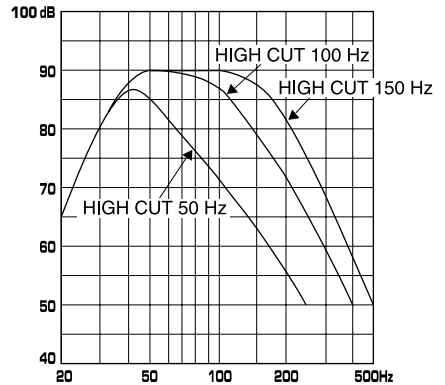

• When combined with NX-430P

HIGH CUT 50-150Hz VOLUME 0-10

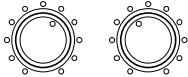

PHASE—Set to the REV (reverse) position.
B.A.S.S.—MOVIE

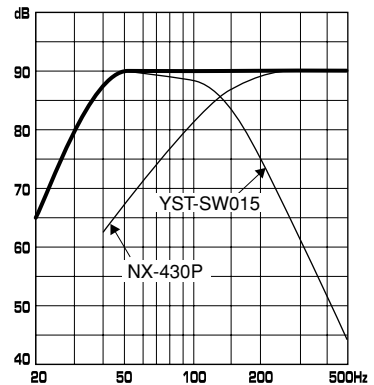

ADVANCED YAMAHA ACTIVE SERVO TECHNOLOGY (for YST-SW015)

The theory of Yamaha Active Servo Technology has been based upon two major factors, the Helmholtz resonator and negative-impedance drive. Active Servo Processing speakers reproduce the bass frequencies through an “air woofer”, which is a port or opening in the speaker’s cabinet. This opening is used instead of, and performs the functions of, a woofer in a conventionally designed speaker system. Thus, signals of low amplitude within the cabinet can, according to the Helmholtz resonance theory, be outputted from this opening as waves of great amplitude if the size of the opening and the volume of the cabinet are in the correct proportion to satisfy a certain ratio.

In order to accomplish this, moreover, the amplitudes within the cabinet must be both precise and of sufficient power because these amplitudes must overcome the “load” presented by the air that exists within the cabinet.

Thus it is this problem that is resolved through the employment of a new design in which the amplifier supplies special signals. If the electrical resistance of the voice coil could be reduced to zero, the movement of the speaker unit would become linear with respect to signal voltage. To accomplish this, a special negative-impedance output-drive amplifier for subtracting output impedance of the amplifier is used. By employing negative-impedance drive circuits, the

amplifier is able to generate precise, low-amplitude, low-frequency waves with superior damping characteristics. These waves are then radiated from the cabinet opening as high-amplitude signals. The system can, therefore, by employing the negative-impedance output drive amplifier and a speaker cabinet with the Helmholtz resonator, reproduce an extremely wide range of frequencies with amazing sound quality and less distortion.

The features described above, then, are combined to be the fundamental structure of the conventional Yamaha Active Servo Technology.

Our new Active Servo Technology — Advanced Yamaha Active Servo Technology — adopted Advanced Negative Impedance Converter (ANIC) circuits, which allows the conventional negative impedance converter to dynamically vary in order to select an optimum value for speaker impedance variation. With this new ANIC circuits, Advanced Yamaha Active Servo Technology can provide more stable performance and improved sound pressure compared with the conventional Yamaha Active Servo Technology, resulting in more natural and dynamic bass reproduction.

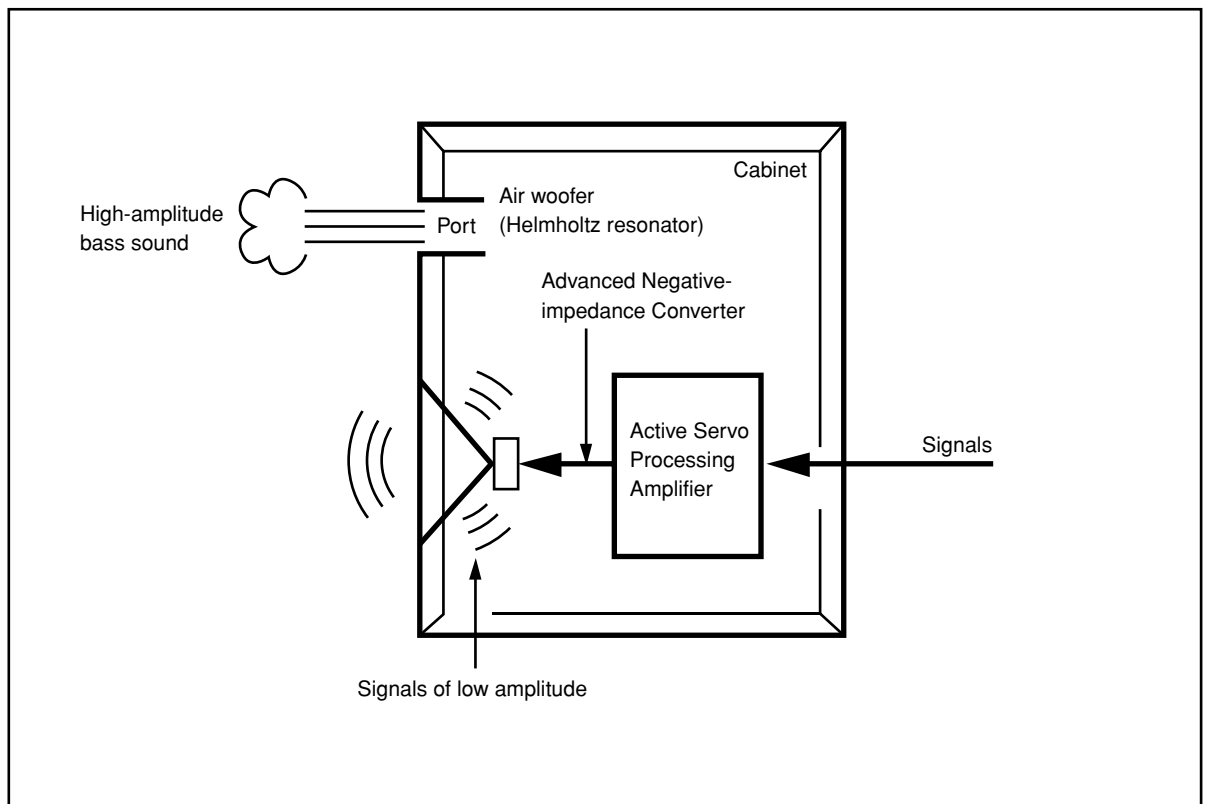

TROUBLESHOOTING

Refer to the chart below when this unit does not function properly. If the problem you are experiencing is not listed below or if the instructions given below do not help, disconnect the power cord and contact your authorized YAMAHA dealer or service center.

Problem	Cause	What to Do
No sound.	Speaker cables are not connected securely.	Connect them securely.
Sound level is too low.	Speaker cables are not connected correctly.	Connect them correctly, that is L (left) to L, R (right) to R, "+" to "+" and "-" to "-".

For YST-SW015

Problem	Cause	What to Do
Power is not supplied even though the STANDBY/ON button is set to the ON position.	The power plug is not securely connected.	Connect it securely.
	The POWER switch is set to the OFF position.	Set the POWER switch to the ON position.
No sound.	The VOLUME control is set to 0.	Turn the VOLUME control to the right.
	Speaker cables are not connected securely.	Connect them securely.
Sound level is too low.	Speaker cables are not connected correctly.	Connect them correctly, that is L (left) to L, R (right) to R, "+" to "+" and "-" to "-".
	Setting of the PHASE switch is not proper.	Set the switch to the other position.
	A source sound with few bass frequencies is played.	Play a source sound with bass frequencies. Set the HIGH CUT control to a higher position.
	It is influenced by standing waves.	Reposition the subwoofer or break up the parallel surface by placing bookshelves etc. along the walls.
The subwoofer does not turn on automatically.	The POWER switch is set to the OFF position.	Set the POWER switch to the ON position.
	The STANDBY/ON button is set to the OFF position.	Set the STANDBY/ON button to the ON position.
	The AUTO STANDBY switch is set to the OFF position.	Set the AUTO STANDBY switch to the "HIGH" or "LOW" position.
	The level of input signal is too low.	Set the AUTO STANDBY switch to the "HIGH" position.
The subwoofer does not turn into the standby mode automatically.	There is an influence of noise generated from external appliances etc.	Move the subwoofer further away from such appliances and/or reposition the connected speaker cables. Otherwise, set the AUTO STANDBY switch to the "OFF" position.
	The AUTO STANDBY switch is set to the OFF position.	Set the AUTO STANDBY switch to the "HIGH" or "LOW" position.
The subwoofer turns into the standby mode unexpectedly.	The level of input signal is too low.	Set the AUTO STANDBY switch to the "HIGH" position.
The subwoofer turns on unexpectedly.	There is an influence of noise generated from external appliances etc.	Move the subwoofer farther away from such appliances and/or reposition the connected speaker cables. Otherwise, set the AUTO STANDBY switch to the "OFF" position.

SPECIFICATIONS

■ NX-430P, NX-C430

Type 2-way acoustic-suspension speaker system
Magnetic shielding type

Driver

<NX-430P> Coaxial 2-way [5 cm (2") cone
and 1.3 cm (1/2") dome] speaker x 1
5 cm (2") full range cone speaker x 1
<NX-C430> Coaxial 2-way [5 cm (2") cone
and 1.3 cm (1/2") dome] speaker x 1
5 cm (2") full range cone speaker x 2

Nominal Input Power 30W

Maximum Input Power 100W

Impedance 6Ω

Frequency Response 70 Hz to 60 kHz

Sensitivity

<NX-430P> 85 dB/2.83V/m
<NX-C430> 86 dB/2.83V/m

Dimensions (W x H x D)

<NX-430P> 87 mm x 184 mm x 147 mm
(3-7/16" x 7-1/4" x 5-13/16")
<NX-C430> 273 mm x 81 mm x 147 mm
(10-3/4" x 3-3/16" x 5-13/16")

Weight

<NX-430P> 1.2 kg (2 lbs. 10 oz.)
<NX-C430> 1.7 kg (3 lbs. 12 oz.)

■ YST-SW015

Type Advanced Yamaha Active Servo Technology
Magnetic shielding type

Driver 16 cm (6-1/2") cone woofer

Amplifier Output 70 W/5Ω

Frequency Response 30 Hz to 200 Hz

Power Supply

U.S.A. and Canada models AC 120V, 60 Hz
U.K. and Europe models AC 230V, 50 Hz
Australia model AC 240V, 50 Hz
China, Korean and General models
..... AC 110-120/220-240V, 50/60 Hz

Power Consumption 70 W

Standby Power Consumption 0.8 W

Dimensions (W x H x D) 280 mm x 325 mm x 320 mm
(11" x 12-13/16" x 12-5/8")

Weight 9.2 kg (20 lbs. 4 oz.)

* Specifications are subject to change without notice due to product improvements.

