

DVD PLAYER

DVD-S661

OWNER'S MANUAL

使用说明书

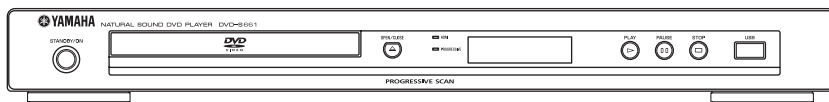

CAUTION: READ THIS BEFORE OPERATING THIS UNIT.

- 1 To assure the finest performance, please read this manual carefully. Keep it in a safe place for future reference.
- 2 Install this unit in a well ventilated, cool, dry, clean place — away from direct sunlight, heat sources, vibration, dust, moisture, or cold. In a cabinet, allow about 2.5 cm (1 inch) of free space all around this unit for adequate ventilation.
- 3 Locate this unit away from other electrical appliances, motors, or transformers to avoid humming sounds.
- 4 Do not expose this unit to sudden temperature changes from cold to hot, nor locate this unit in an environment with high humidity (i.e., a room with a humidifier) to prevent condensation inside this unit, which may cause an electrical shock, fire, damage to this unit, and/or personal injury.
- 5 Avoid installing this unit in a location where foreign objects may fall onto this unit or where this unit may be exposed to liquid dripping or splashing. On the top of this unit, do not place:
 - Other components, as they may cause damage and/or discoloration on the surface of this unit.
 - Burning objects (i.e., candles), as they may cause fire, damage to this unit, and/or personal injury.
 - Containers with liquid in them, as they may fall, spilling the liquid and causing an electrical shock to the user and/or damage to this unit.
- 6 Do not cover this unit with a newspaper, tablecloth, curtain, etc. in order not to obstruct heat radiation. If the temperature inside this unit rises, it may cause fire, damage to this unit, and/or personal injury.
- 7 Do not plug in this unit to a wall outlet until all connections are complete.
- 8 Do not operate this unit upside-down. It may overheat, possibly causing damage.
- 9 Do not use excessive force on switches, knobs and/or cords.
- 10 When disconnecting the power cord from the wall outlet, grasp the plug; do not pull the cord.
- 11 Do not clean this unit with chemical solvents; this might damage the finish. Use a clean, dry cloth.
- 12 Use only the voltage specified on this unit. Using this unit with a higher voltage than specified is dangerous and may cause fire, damage to this unit, and/or personal injury. Yamaha will not be held responsible for any damage resulting from use of this unit with a voltage other than as specified.
- 13 Do not attempt to modify or fix this unit. Contact qualified Yamaha service personnel when any service is needed. The cabinet should never be opened for any reason.
- 14 When not planning to use this unit for long periods of time (i.e., vacation), disconnect the AC power plug from the wall outlet.
- 15 Be sure to read the “Troubleshooting” section on common operating errors before concluding that this unit is faulty.
- 16 Before moving this unit, press STANDBY/ON to set the unit in standby mode, then disconnect the AC power plug from the wall outlet.
- 17 Install this unit near the AC outlet and where the AC power plug can be reached easily.
- 18 The batteries shall not be exposed to excessive heat such as sunshine, fire or the like.

The unit is not disconnected from the AC power source as long as it is connected to the wall outlet, even if this unit itself is turned off. This state is called the standby mode. In this state, this unit is designed to consume a very small quantity of power.

WARNING

TO REDUCE THE RISK OF FIRE OR ELECTRIC SHOCK, DO NOT EXPOSE THIS UNIT TO RAIN OR MOISTURE.

CAUTION

Use of controls or adjustments or performance of procedures other than those specified herein may result in hazardous radiation exposure.

LASER SAFETY

This unit employs a laser. Due to possible eye injury, only a qualified service person should remove the cover or attempt to service this device.

DANGER

This unit emits visible laser radiation when open. Avoid direct eye exposure to beam.
When this unit is plugged into a wall outlet, do not place your eyes close to the opening of the disc tray and other openings or look inside.

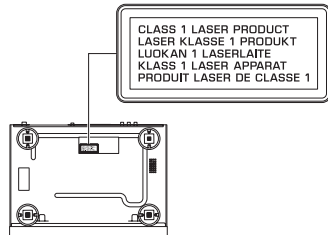

DANGER: AVOID DIRECT EXPOSURE TO THE BEAM
INVISIBLE LASER RADIATION WHEN OPEN
DO NOT STARE INTO BEAM
CAUTION: INVISIBLE LASER RADIATION WHEN OPEN

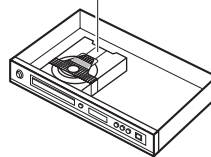

Introduction	3
Supplied accessories	3
Region codes	3
Playable disc formats	3
Cleaning discs	4
Patent information	4
<hr/>	
Functional Overview	5
Front panel	5
Rear panel	6
Remote control	7
<hr/>	
Connections	8
General notes on connections	8
Audio connections	8
Digital connection	8
Analog connection	8
Video connections	9
Component video jacks <A>	9
S-video jack 	9
Composite video jack <C>	9
HDMI connection	10
HDMI jack	10
Other connections	11
USB port	11
Remote control jacks	11
<hr/>	
Getting Started	12
Step 1: Inserting batteries into the remote control	12
Using the remote control	12
Step 2: Turning on the power	12
Step 3: Setting a TV type/display and language	13
Setting a color system for your TV	13
Setting an aspect ratio for your TV	13
Setting the OSD language	14
Setting the audio, subtitle and disc menu languages (DVD-Video only)	14

Playback Operation	15
Basic operation	15
Selecting a track/chapter	15
Searching backward/forward	15
Repeat/Shuffle functions	15
Repeat/Shuffle playback	15
Repeating a section within a chapter/track	16
Operations for video playback (DVD/VCD/SVCD)	16
Using the disc menu	16
Playback in slow motion	16
Zooming pictures in/out	16
Resuming playback from the last stopped point	16
Using the on-screen display (OSD)	17
Special DVD features	18
Playing by title	18
Selecting an audio language/format and subtitle language	18
Special VCD/SVCD features	18
Using the playback control (PBC) menu	18
Playing data discs (MP3/WMA/JPEG/DivX)	18
Selecting a folder and track/file	19
Special picture disc features	19
Using the preview function	19
Zooming pictures in/out	19
Playback with multi-angles	20
Playing MP3 music and JPEG picture simultaneously	20
Special DivX features	20
Using the interactive menu	20
Selecting an audio/subtitle language	20
Using a USB device	21
Supported USB devices	21
Playing data files	21

Contents

Setup Menu 22**General setup menu 22**

Locking/Unlocking the disc for viewing22

Dimming the front panel display22

Programming disc tracks (except MP3/

WMA/JPEG/DivX)22

OSD language23

Setting the screen saver23

Setting the sleep timer24

Setting the auto standby function24

Displaying the DivX® VOD
registration code24**Audio setup menu 24**

Setting the analog output25

Setting the digital output25

Turning the HDMI audio on/off25

Turning the night mode on/off26

Setting the lip synchronization26

Video setup menu 26

TV type26

Setting the TV display27

Turning the progressive scan function on/off ...27

Adjusting picture settings28

Setting the HDMI video29

Preference setup menu 30

Audio, subtitle and disc menu30

Restricting playback with parental control30

Selecting playback of VR format30

Selecting the MP3/JPEG menu31

Displaying DivX external subtitle files31

Selecting the PBC (playback control)
function32

Changing the password32

Resetting the system32

Language Codes 33

Troubleshooting 34

Glossary 37

Specifications 39

Thank you for purchasing this unit. This owner's manual explains the basic operation of this unit.











This manual is printed prior to production. Design and specifications are subject to change in part as a result of improvements, etc. In case of differences between the manual and the product, the product has priority.

Supplied accessories

- Remote control
- Two batteries (AAA, R03, UM-4) for the remote control
- Audio/Video pin cable
- Owner's manual

Region codes

This unit is designed to support the region management system. Check the regional code number on the DVD disc package. If the number does not match the region code of this unit (see the table below or the back of this unit), this unit may be unable to play the disc.

Destination	Region code of this unit	Playable discs
U.S.A., Canada		 
U.K., Europe		 
Asia, Korea		 
Australia, Central and South America		 

Playable disc formats

This unit is designed for use with discs having the logos shown below. Do not attempt to load any other type of disc into this unit.



This unit can play:

- DVD-R/RW/R DL and DVD+R/RW/R DL discs recorded in DVD-Video compatible format
- DVD-RW discs recorded in VR format (compatible with CPRM)
- MP3, WMA and JPEG files recorded on CD-R/RW, DVD-R/RW, DVD+R/RW and USB
- KODAK picture CDs, FUJICOLOR CDs
- ISO 9660 Level1/Level2 for CD-R/RW
- Up to 298 folders per disc/USB device and up to 648 files per folder with up to 8 hierarchies
- DivX[®] files recorded on CD-R/RW, DVD-R/RW, DVD+R/RW and USB
 - Official DivX[®] Ultra Certified product
 - Plays all versions of DivX[®] video (including DivX[®] 6) with enhanced playback of DivX[®] media files and the DivX[®] Media Format

Notes

- CD-R/RW, DVD-R/RW/R DL and DVD+R/RW/R DL cannot be played unless finalized.
- Progressive JPEG and copyright-protected WMA files cannot be played with this unit.
- Only the first session of DVD-R/RW/R DL and DVD+R/R DL can be played.
- Some discs cannot be played depending on disc characteristics or recording conditions.
- Do not use any non-standard shaped discs (heart-shaped, etc.).
- Do not use discs with tape, seals, paste or many scratches on their surface.
- For details about playable formats, see “Specifications” on page 39.

Introduction

Cleaning discs

- When a disc becomes dirty, clean it with a cleaning cloth. Wipe the disc from the center out. Do not wipe in a circular motion.
- Do not use solvents such as benzine, thinner, commercially available cleaners, or antistatic spray intended for analog records.

Patent information



Manufactured under license from Dolby Laboratories. “Dolby”, “Pro Logic” and the double-D symbol are trademarks of Dolby Laboratories.



“DTS” and “DTS Digital Out” are registered trademarks of DTS, Inc.



DivX, DivX Ultra Certified, and associated logos are trademarks of DivX, Inc. and are used under license.



HDMI, the HDMI logo and High Definition Multimedia Interface are trademarks or registered trademarks of HDMI Licensing LLC.

This product incorporates copyright protection technology that is protected by method claims of certain U.S. patents and other intellectual property rights owned by Macrovision Corporation and other rights owners. Use of this copyright protection technology must be authorized by Macrovision Corporation, and is intended for home and other limited viewing uses only unless otherwise authorized by Macrovision Corporation. Reverse engineering or disassembly is prohibited.

Front panel

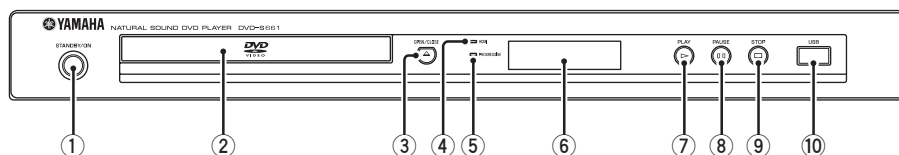

- ① **STANDBY/ON**
Turns on this unit or sets it to the standby mode.
- ② **Disc tray**
Loads a disc in the disc tray.
- ③ **OPEN/CLOSE (△)**
Opens or closes the disc tray.
- ④ **HDMI indicator**
Lights up when an HDMI component is connected, and signals output via the HDMI jack of this unit.
- ⑤ **PROGRESSIVE indicator**
Lights up when this unit enters the progressive mode.
- ⑥ **Front panel display**
Shows the current status of this unit.
- ⑦ **PLAY (▶)**
Starts playback.
- ⑧ **PAUSE (▢▢)**
Pauses playback.
- ⑨ **STOP (□)**
Stops playback.
- ⑩ **USB port**
Connect to the USB port of your USB device (see page 11).

Functional Overview

Rear panel

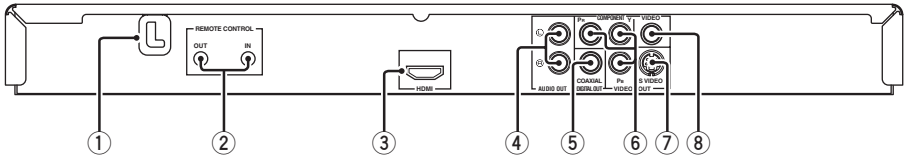

- ① **AC power cable**
Plug the power cable into the AC wall outlet.
- ② **REMOTE CONTROL (IN, OUT) jacks**
Connect the REMOTE CONTROL (IN) jack of this unit to the remote control output jack of your Yamaha AV receiver.
Connect the REMOTE CONTROL (OUT) jack of this unit to the remote control input jack of your Yamaha component (see page 11).
- ③ **HDMI jack**
Connect to the HDMI input jack of your HDMI component (see page 10).
- ④ **AUDIO OUT (L, R) jacks**
Connect to the audio input jacks of your AV receiver or stereo system (see page 8).
- ⑤ **DIGITAL OUT - COAXIAL jack**
Connect to the coaxial input jack of your AV receiver (see page 8).
- ⑥ **VIDEO OUT - COMPONENT (Y, Pb, Pr) jacks**
Connect to the component input jacks of your AV receiver (see page 9).
- ⑦ **VIDEO OUT - S VIDEO jack**
Connect to the S-video input jack of your AV receiver (see page 9).
- ⑧ **VIDEO OUT - VIDEO jack**
Connect to the composite video input jack of your AV receiver (see page 9).

Caution: Do not touch the inner pins of the jacks on the rear panel of this unit.
Electrostatic discharge may cause permanent damage to this unit.

Remote control

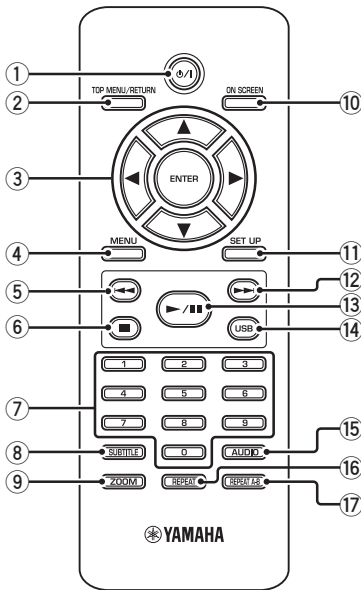

- ① **⏻/⏻**
Turns on this unit or sets it to the standby mode.
- ② **TOP MENU/RETURN**
Displays the top-level disc menu (DVD).
Moves back to the previous menu (DVD*/VCD)
(see page 18).
- ③ **◀/▶/▲/▼**
Selects an item in the currently displayed menu.
Search or slow playback.
ENTER
Confirms the menu selection.
- ④ **MENU**
Displays the menu of a disc (DVD/JPEG)
(see pages 16, 18, 19 and 20).
Switches PBC on or off (VCD) (see page 18).

- ⑤ **◀◀**
Moves to the previous chapter or track.
Searches backward.*
- ⑥ **■**
Stops playback.
Opens the disc tray.*
- ⑦ **Numeric buttons (0-9)**
Selects numbered items in the currently
displayed menu.
- ⑧ **SUBTITLE**
Selects the subtitle language (see pages 18 and
20).
- ⑨ **ZOOM**
Enlarges the video image (see pages 16 and 19).
- ⑩ **ON SCREEN**
Accesses or exits from the on-screen display
(OSD) menu of this unit (see page 17).
- ⑪ **SET UP**
Accesses or exits from the setup menu of this
unit (see pages 13 and 22).
- ⑫ **▶▶**
Moves to the next chapter or track.
Searches forward.*
- ⑬ **▶/||**
Starts or pauses playback.
- ⑭ **USB**
Accesses the contents of the connected USB
device or exits from the USB mode (see
page 21).
- ⑮ **AUDIO**
Selects the audio language or format (see
pages 18 and 20).
- ⑯ **REPEAT**
Accesses or exits from the repeat/shuffle mode
(see page 15).
- ⑰ **REPEAT A-B**
Repeats a specific segment (see page 16).

* Press and hold the button for about two seconds.

Connections

General notes on connections

Be sure to turn off this unit and unplug the power cable before you make or change connections.

- Depending on the component you want to connect, there are various ways to make connections. Possible connections are described below.
- Refer to the manuals supplied with your other components as necessary to make the best connections.
- Do not connect this unit via your VCR. The video quality could be distorted by the copy protection system.
- Do not connect the audio out jack of this unit to the phono in jack of your audio system.

Audio connections

Digital connection

This unit has a digital coaxial output jack. Connect the DIGITAL OUT - COAXIAL jack of this unit to your AV receiver equipped with a Dolby Digital, DTS, or MPEG decoder using a commercially available coaxial cable.

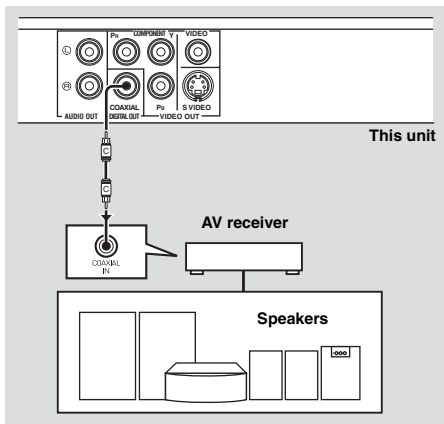

Notes

- You need to set [DIGITAL OUTPUT] to [ALL] (see “DIGITAL OUTPUT” on page 25).
- If the audio format of the digital output does not match the capabilities of your receiver, the receiver produces a distorted sound or no sound at all. Make sure to select the appropriate audio format from the menu screen on the disc. Pressing AUDIO on the remote control once or more may change not only the audio languages but also the audio format. The selected format appears in the front panel display for several seconds.
- If you want to enjoy Dolby Digital, DTS and MPEG formats, you must connect this unit to an AV receiver that supports these formats.

Analog connection

This unit has 2-ch analog output jacks. Connect the AUDIO OUT (L, R) jacks of this unit to the corresponding input jacks of your audio component (such as a stereo amplifier) using the supplied audio pin cable.

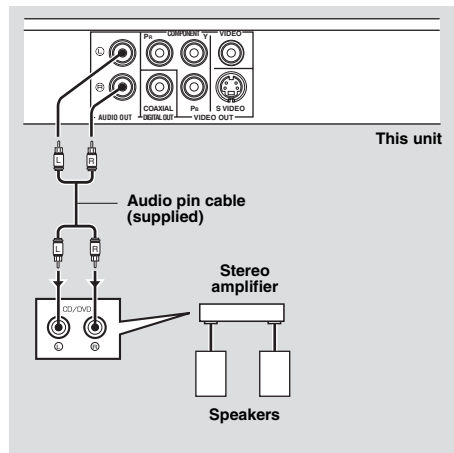

Video connections

If your AV receiver has video output jacks, connect your receiver and then your TV so that you can use one TV for several different video sources (LD, VCR, etc.) by simply switching the input source selector of your receiver.

This unit has several types of video output jacks. Use the one that corresponds to the input jacks of the component to be connected.

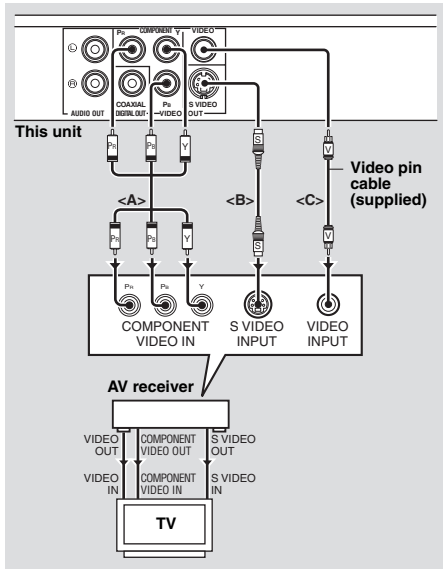

Component video jacks <A>

Component video connections achieve higher fidelity color reproduction than S-video connections by transmitting video signals on separate wires for luminance (Y: green) and chrominance (PB: blue, PR: red).

Connect the VIDEO OUT - COMPONENT (Y, P_B, P_R) jacks of this unit to component input jacks of your AV receiver and then to those of your TV using a commercially available component cable. Observe the color of each jack when you make connections.

If your receiver does not have component output jacks, you can achieve a better video image by connecting the component output jacks of this unit directly to the component input jacks of your TV.

S-video jack

S-video connections achieve a clearer picture than composite video connections by transmitting video signals on separate wires for luminance (Y) and chrominance (C).

Connect the VIDEO OUT - S VIDEO jack of this unit to an S-video input jack of your AV receiver and then to that of your TV using a commercially available S-video cable.

Composite video jack <C>

Connect the VIDEO OUT - VIDEO jack of this unit to a video input jack of your AV receiver and then to that of your TV using the supplied video pin cable.

Connections

HDMI connection

HDMI jack

HDMI provides high quality digital audio and video on a single connection.

Connect the HDMI jack of this unit to an HDMI input jack of your AV receiver, and then to that of your TV using a commercially available HDMI cable.

If your receiver does not have an HDMI input jack, you can achieve a better video image by connecting the HDMI jack of this unit directly to the HDMI input jack of your TV.

This unit can display High-Definition JPEG images (720p or 1080i) when you connect this unit to an HDTV via the HDMI jack. For details, see “HD JPEG” on page 29.

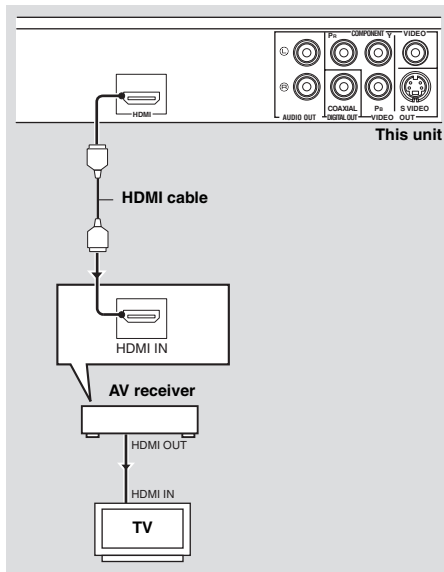

Notes

- You need to set [HDMI AUDIO] (see page 25) and [HDMI VIDEO] (see page 29).
- You need to make an appropriate audio connections if the connected component does not output audio signals (see “Audio connections” on page 8).
- This unit is not compatible with HDCP-incompatible HDMI or DVI components.
- You need a commercially available HDMI/DVI conversion cable when you connect this unit to other DVI components. In this case, the HDMI jack of this unit does not output any audio signals.
- Depending on the connected DVI component, black and white in the image may not be distinct. In that case, adjust the picture setting of the connected DVI component.
- Do not disconnect or turn off the power of the HDMI/DVI component connected to the HDMI jack of this unit while data is being transferred. Doing so may disrupt playback or cause noise.
- When connecting an HDMI component, refer to the manual supplied with your component.

Other connections

USB port

This unit has a USB port and can access MP3, WMA, DivX and JPEG files saved on your USB device.

Connect the USB port on the front panel of this unit to a USB port of your USB device.

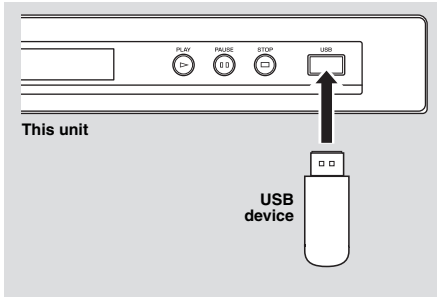

Notes

- This unit may not recognize some USB devices.
- For details about the USB features, see “Using a USB device” on page 21.

Remote control jacks

This unit has remote control input/output jacks. If your AV receiver is a Yamaha product and has the capability to transmit of SCENE control signals, you can use the SCENE function.

Connect the REMOTE CONTROL (IN) jack of this unit to a remote control output jack of your receiver using a commercially available monaural mini-jack cable so that this unit starts playback automatically by simply pressing a button of your receiver.

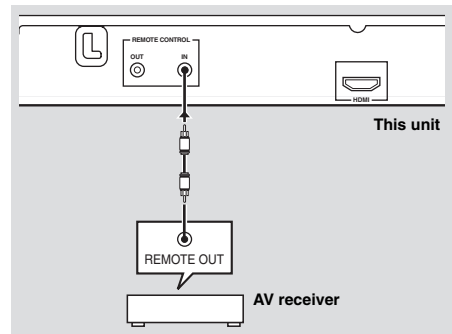

Note

For details about the SCENE function, refer to the owner’s manual supplied with your Yamaha AV receiver.

Getting Started

Step 1: Inserting batteries into the remote control

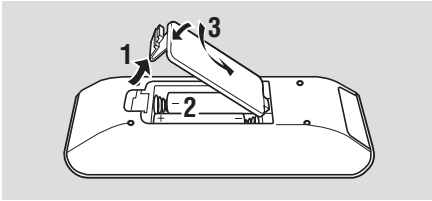

- 1 Open the battery compartment.
- 2 Insert the two supplied batteries (AAA, R03, UM-4) following the indications (+/-) inside the compartment.
- 3 Close the cover.

Notes

- Insert batteries correctly according to the polarity markings (+/-). Batteries inserted in the opposite orientation may leak.
- Replace the exhausted batteries immediately with new ones to prevent leakage.
- Remove the batteries from the compartment if the remote control is not used for more than a month.
- If the batteries have leaked, dispose of them immediately. Avoid touching the leaked material or letting it come into contact with clothing, etc. Clean the battery compartment thoroughly before installing new batteries.
- Do not use old batteries together with new ones.
- Do not use different types of batteries (such as alkaline and manganese batteries) together. Read the packaging carefully as these different types of batteries may have the same shape and color.
- Dispose of the batteries correctly in accordance with your local regulations.

Using the remote control

Use the remote control within 6 m of this unit and point it toward the remote control sensor.

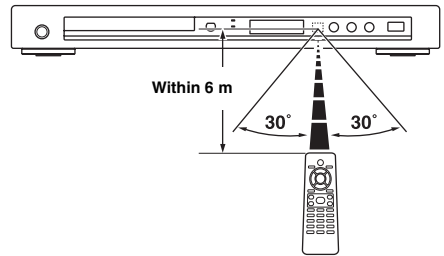

Notes

- Do not spill water or other liquids on the remote control.
- Do not drop the remote control.
- Do not leave or store the remote control in the following types of conditions:
 - places of high humidity, such as near a bath
 - places of high temperature, such as near a heater or stove
 - places of extremely low temperature
 - dusty places
- When the remote control works unstably, point it at an angle upward to the sensor.

Step 2: Turning on the power

- 1 Plug the power cable into the AC outlet.
- 2 Turn on your TV and AV receiver.
- 3 Select the appropriate input source of the AV receiver (refer to the manual supplied with your AV receiver).
- 4 Press **STANDBY/ON** on the front panel or \odot /I on the remote control to turn on this unit.
 - The front panel display lights up.
- 5 Set the TV to the correct video input (refer to the manual supplied with your TV).
 - The default screen appears on the TV.

Step 3: Setting a TV type/display and language

You can customize this unit using the setup menu displayed on the TV screen.

Notes

- Unless stated otherwise, all operations described here are carried out using the supplied remote control.
- To return to the previous menu, press **◀**.
- To exit from the menu, press **SET UP**.

Setting a color system for your TV

This unit is compatible with both NTSC and PAL video formats. Select the color system that matches your TV.

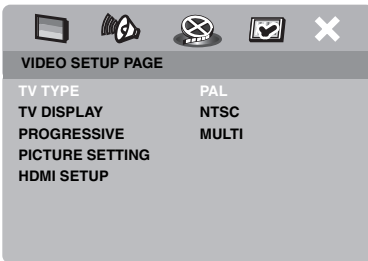

- 1 Press **SET UP**.
- 2 Press **▶** repeatedly to select “VIDEO SETUP PAGE”.
- 3 Press **▲/▼** to highlight [TV TYPE], and then press **▶**.
- 4 Press **▲/▼** to highlight one of the following options.

PAL

Select this if the connected TV is a PAL system TV. It will change the video signals of NTSC discs and output them in PAL format.

NTSC

Select this if the connected TV is an NTSC system TV. It will change the video signals of PAL discs and output them in NTSC format.

MULTI

Select this if the connected TV is compatible with both NTSC and PAL formats (such as a multi-system TV).

The output format will be in accordance with the video signals of the disc.

- 5 Select an item, and then press **ENTER**.

Notes

- Before changing the current TV standard setting, ensure that your TV supports the selected TV type.
- If the picture is not displayed properly on your TV, wait for 15 seconds for this unit to activate automatic recovery.
- When making HDMI connections, you cannot change or select [TV TYPE].



Setting an aspect ratio for your TV

You can set the aspect ratio of this unit to match your TV. If the aspect ratio of your TV is 4:3, you do not need to change this setting. If you have a widescreen TV, change this setting according to the procedure below. For details, see “Setting the TV display” on page 27.

Getting Started

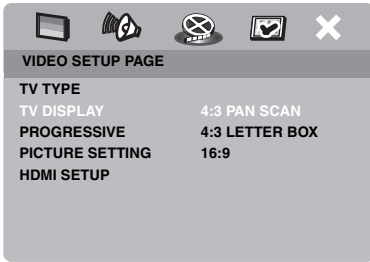

- 1 Press **SET UP**.
- 2 Press **▶** repeatedly to select “VIDEO SETUP PAGE”.
- 3 Press **▲/▼** to highlight [TV DISPLAY], and then press **▶**.
- 4 Press **▲/▼** to highlight [16:9], and then press **ENTER**.

Setting the OSD Language

You can select your own preferred language for the setup menu. This setting remains once selected.

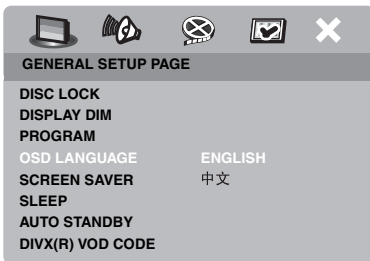

- 1 Press **SET UP**.
- 2 Press **◀/▶** to select “GENERAL SETUP PAGE”.
- 3 Press **▲/▼** to highlight [OSD LANGUAGE], and then press **▶**.
- 4 Press **▲/▼** to select a language, and then press **ENTER**.

Setting the audio, subtitle and disc menu languages (DVD-Video only)

You can select your own preferred language for the audio, subtitle and disc menu. This unit automatically switches to the selected language whenever you load a disc. If the selected language is not available on the disc, the default language of the disc will be used instead.



- 1 Press **■** twice, and then press **SET UP**.
- 2 Press **▶** repeatedly to select “PREFERENCE PAGE”.
- 3 Press **▲/▼** to highlight one of the options below, and then press **▶**.
 - AUDIO (audio language)
 - SUBTITLE (subtitle language)
 - DISC MENU (disc menu language)
- 4 Press **▲/▼** to select a language, and then press **ENTER**.
- 5 Repeat steps **3-4** for other language settings.

■ To select a language not in the list

- 1 Select [OTHERS] in [AUDIO] or [SUBTITLE] or [DISC MENU].
- 2 Use the **numeric buttons (0-9)** to enter the 4-digit language code (see “Language Codes” on page 33), and then press **ENTER**.

Notes

- If the prohibited icon (⊘) appears on the TV screen when a button is pressed, the function for that button is not available on the current disc or at the current time.
- Unless stated otherwise, all operations described here are carried out using the supplied remote control.
- Depending on the disc, some operations may operate differently or be restricted. Refer to the instruction supplied with the disc.
- Do not push on the disc tray or put any objects other than discs on the disc tray. Doing so may cause this unit to malfunction.

Basic operation

- 1 Make sure this unit is turned on.
- 2 Press **OPEN/CLOSE** (△) on the front panel to open the disc tray.
- 3 Place the disc in the disc tray with the printed side up.
- 4 Press **OPEN/CLOSE** (△) again to close the disc tray.
 - After recognizing the disc, this unit starts playback automatically.
 - If you press ►/|| when the disc tray is open, the disc tray closes and playback starts automatically.
- 5 To pause playback, press ►/|| during playback.
 - Playback is paused and the sound is muted.
 - Frame-by-frame playback can be done by pressing **PAUSE** (□□) on the front panel repeatedly.
- 6 To resume normal playback, press ►/|| again.
- 7 To stop playback, press ■ .

Selecting a track/chapter

- 1 Press ◀◀ / ▶▶ or use the **numeric buttons (0-9)** to select a track/chapter number.
- 2 During repeated playback, press ◀◀ / ▶▶ to replay the same track/chapter.

Searching backward/forward

- 1 Press and hold ◀◀ / ▶▶ or press ◀ / ▶ .
- 2 While searching, press ◀◀ / ▶▶ or ◀ / ▶ repeatedly to select the desired speed.
- 3 To resume normal playback, press ►/|| .

Notes

- The ◀ / ▶ key may not be available with some discs.
- For MP3 and WMA, the search function allows you to search the track currently being played.

Repeat/Shuffle functions

Repeat/Shuffle playback

Each time you press **REPEAT** during playback, the front panel display changes as follows:

DVD

- RPT ONE (repeat chapter)
- RPT TT (repeat title)
- RPT ALL (repeat all)
- SHUFFLE (shuffle)
- RPT SHF (shuffle repeat)
- RPT OFF (repeat off)

VCD/SVCD/CD

- RPT ONE (repeat track)
- RPT ALL (repeat all)
- SHUFFLE (shuffle)
- RPT SHF (shuffle repeat)
- RPT OFF (repeat off)

Playback Operation

MP3/WMA/DivX

- RPT ONE (repeat track)
- RPT FLD (repeat folder)
- SHUFFLE (shuffle)
- RPT OFF (repeat off)

Note

For VCD, repeat playback is not available when the PBC mode is on.

Repeating a section within a chapter/track

- 1 While playing a disc, press **REPEAT A-B** at the desired starting point.
 - “SET A” appears in the front panel display.
- 2 Press **REPEAT A-B** again at the desired end point.
 - A and B can only be set within the same chapter/track.
 - “RPT AB” appears in the front panel display and the selected section repeats continuously.
- 3 To exit from the sequence, press **REPEAT A-B**.

Operations for video playback (DVD/VCD/SVCD)

Using the disc menu

Depending on the disc, a menu may appear on the TV screen once you load the disc.

■ To select a playback feature or item

Use ◀ / ▶ / ▲ / ▼ or the **numeric buttons (0-9)**, and then press **ENTER** to start playback.

■ To access or exit from the menu

Press **MENU**.

Playback in slow motion

You can play back video in slow motion.

- 1 Press ▲ for reverse slow motion or ▼ for forward slow motion.
- 2 During slow motion, press ▲/▼ repeatedly to select the desired speed.
- 3 To resume normal playback, press ▶/|| or **ENTER**.

Note

For VCD and SVCD, reverse slow motion is not available.

Zooming pictures in/out

You can enlarge or shrink the picture on the TV screen and pan through the enlarged picture.

- 1 During playback, press **ZOOM** repeatedly to display the picture at different scales.
 - Use ◀ / ▶ / ▲ / ▼ to pan through the enlarged picture.
 - Playback continues.
- 2 Press **ZOOM** repeatedly to return to the original size.

Resuming playback from the last stopped point

You can resume playback of the last ten discs, even if the discs were ejected or the power of this unit was turned off.

- 1 Load one of the last ten discs.
 - “LOADING” appears on the TV screen.
- 2 Press ▶/|| while “LOADING” is displayed on the TV screen.
 - “RESUME PLAY” appears on the TV screen and the disc is played back from the last point.

■ To cancel the resume mode

When playback is stopped, press ■ again.

Using the on-screen display (OSD)

The OSD menu shows disc playback information (e.g., the title or chapter number, elapsed playing time or audio/subtitle language). A number of operations are possible without interrupting disc playback.

- 1 During playback, press **ON SCREEN**.
→ A list of available disc information appears on the TV screen.

DVD

MENU		▶
TITLE	02/14	
CHAPTER	02/14	
AUDIO	5.1CH	
SUBTITLE	ENG	▼
BITRATE 16 III		TITLE ELAPSED 0:02:25

VCD/SVCD

MENU		▶
TRACK	02/14	
DISC TIME	0:49:17	
TRACK TIME	0:03:43	
REPEAT	OFF	▼
BITRATE 16 III		TOTAL ELAPSED 0:02:25

- 2 Press ▲/▼ to scroll the information, and then press **ENTER** to access the selected item.
- 3 Use the **numeric buttons (0-9)** to input the number/time or press ▲/▼ to make a selection, and then press **ENTER**.
→ Playback changes to the selected time or to the selected title/chapter/track.

■ Title/Chapter/Track selection (DVD/VCD)

- 1 Press ▲/▼ to select [TITLE] or [CHAPTER] (DVD) or [TRACK] (VCD).
- 2 Press **ENTER**.
- 3 Select a title, chapter or track number using the **numeric buttons (0-9)**.

■ Time search (DVD/VCD)

- 1 Press ▲/▼ to select [TT TIME] / [CH TIME] (DVD) or [TRACK TIME] / [DISC TIME] (VCD).
 - [TT TIME] refers to the total time of the current title, and [CH TIME] refers to the total time of the current chapter.
- 2 Press **ENTER**.
- 3 Enter hours, minutes and seconds from left to right using the **numeric buttons (0-9)** (e.g. 0:34:27).

■ Audio/Subtitle/Angle selection (DVD)

You can change [AUDIO], [SUBTITLE] or [ANGLE] if these functions are available on the disc you are playing.

- 1 Press ▲/▼ to select [AUDIO], [SUBTITLE] or [ANGLE].
- 2 Press **ENTER**.
- 3 For Audio and Subtitle:
Press ▲/▼ to highlight your selection, and then press **ENTER**.

OR

For Angle:

Select an angle using the **numeric buttons (0-9)**.

Playback Operation

■ Repeat/Time Display (DVD/VCD)

- 1 Press **▲/▼** to select [REPEAT] or [TIME DISP.].
- 2 Press **ENTER**.
- 3 Press **▲/▼** to highlight your selection, and then press **ENTER**.

■ Time display (CD)

Each time you press **ON SCREEN**, the time display changes as follows:

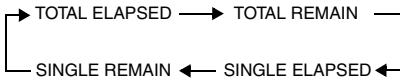

Special DVD features

Playing by title

- 1 Press **MENU**.
→ The disc title menu appears on the TV screen.
- 2 Use **◀/▶/▲/▼** or the **numeric buttons (0-9)** to select a playback option.
- 3 Press **ENTER**.

Selecting an audio language/format and subtitle language

■ To select an audio language/format

Press **AUDIO** repeatedly to select an audio language and/or format.

■ To select a subtitle language

Press **SUBTITLE** repeatedly to select a subtitle language.

Special VCD/SVCD features

Using the playback control (PBC) menu

For a VCD with a playback control (PBC) feature (version 2.0 only)

- 1 Press **MENU** to toggle between “PBC ON” and “PBC OFF”.
→ If you select “PBC ON”, the disc menu appears (if available) on the TV screen.
 - 2 Use the **numeric buttons (0-9)** to select a playback option.
 - Press **◀◀/▶▶** to move to the previous/next page (if available).
 - 3 During playback, press **TOP MENU/RETURN** to return to the menu screen.
- **To skip the index menu and play back a disc from the beginning**
Press **MENU** to turn off the PBC function.

Playing data discs (MP3/WMA/JPEG/DivX)

- 1 Load a data disc.
 - The disc reading time may exceed 30 seconds due to the complexity of the directory/file configuration.
 - The data disc menu appears on the TV screen.

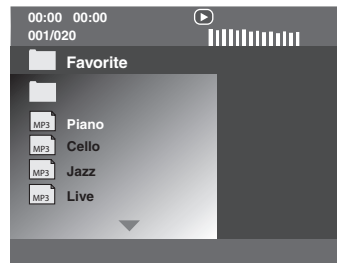

- 2 Playback starts automatically. If not, press **▶/||**.
- 3 Press **◀◀/▶▶** to select another track/file in the current folder.

Notes

- It may not be possible to play certain MP3/WMA/JPEG/DivX discs due to the configuration and characteristics of the discs or the recording conditions.
- HD JPEG images may not be displayed correctly when the first image is displayed or the disc is ejected. For details about HD JPEG, see “HD JPEG” on page 29.
- Depending on the picture size, HD JPEG images may appear smaller in size.

Selecting a folder and track/file

- 1 Press **▲/▼** to select a folder, and then press **ENTER** to open the folder.
- 2 Press **▲/▼** to select a track/file.
- 3 Press **ENTER**.
 - Playback starts from the selected file to the end of the folder.

Special picture disc features

- 1 Load a picture disc (JPEG, Kodak Picture CD or Fujicolor CD).
 - For JPEG, the picture menu appears on the TV screen.
 - For Kodak Picture CD and Fujicolor CD, the slideshow begins.

■ For JPEG

- 2 Press **▶/||** to start the slideshow.

Using the preview function

This function displays the content of the current folder or the entire disc.

- 1 Press **■** during playback.
 - 12 thumbnails appear on the TV screen.

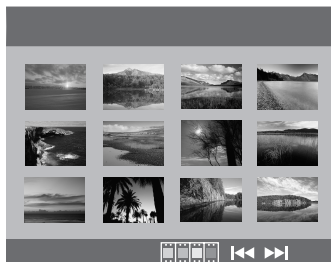

- 2 Press **◀◀/▶▶** to display the other thumbnails on the previous/next page.
- 3 Use **◀/▶/▲/▼** to highlight one of the thumbnails, and then press **ENTER** to start playback.

OR

Move the cursor to highlight **■** on the bottom of the page to start playback from the first thumbnail on the current page.

■ For JPEG

- 4 Press **MENU** to return to the JPEG disc menu.

Zooming pictures in/out

- 1 During playback, press **ZOOM** repeatedly to display the picture at different scales.
- 2 Use **◀/▶/▲/▼** to pan through the enlarged picture.

Playback Operation

Playback with multi-angles

During playback, press ◀ / ▶ / ▲ / ▼ to rotate the picture on the TV screen.

- ◀: rotates the picture counter-clockwise
- ▶: rotates the picture clockwise
- ▲: flips the picture vertically
- ▼: flips the picture horizontally

Note

For HD JPEG, the ▲/▼ key is not available.

Playing MP3 music and JPEG pictures simultaneously

- 1 Load a disc that contains both MP3 music and JPEG picture data.
 - The disc menu appears on the TV screen.
- 2 Select an MP3 music track.
- 3 During MP3 music playback, select a JPEG picture file from the TV screen, and then press ▶/II .
 - The picture files are played back one after another until the end of the folder.
- 4 To quit simultaneous playback, press **MENU**, and then press ■ .

Notes

- Some files cannot be played correctly depending on disc characteristics or recording conditions.
- This function is not available when [HD JPEG] is set to [ON] (see page 29).

Special DivX features

DivX files including DMF (DivX Media Format) features only

Using the interactive menu

- 1 Load a disc.
 - The interactive menu appears on the TV screen.
- 2 Use ◀ / ▶ / ▲ / ▼ to select a chapter.
- 3 Press **ENTER** or ▶/II to start playback of the selected chapter.

■ To access the interactive menu

During playback, press **MENU**.

■ To return to the data disc menu screen

When the interactive menu is displayed, press ■ .

Selecting an audio/subtitle language

■ To select an audio language

During playback, press **AUDIO** to switch the audio language recorded on the contents.

■ To select a subtitle language

During playback, press **SUBTITLE** to switch or turn on/off the subtitle language recorded on the contents.

Note

For information about external subtitle files, see “Displaying DivX external subtitle files” on page 31.

Using a USB device

You can play back MP3, WMA, JPEG and DivX files saved on your supported USB device.

Supported USB devices

This unit supports USB mass storage class devices (e.g., flash memories, card readers, portable audio players) using FAT16 or FAT32 format.

Notes

- Some devices may not work properly even if they meet the requirements.
- If “Device not supported” appears on the TV screen when you connect the USB device, follow the procedure below.
 - Set this unit to the standby mode, and then turn it on again.
 - Disconnect the device when this unit is in the standby mode, then connect it again and turn on this unit.
 - Connect the AC adapter if the adapter is supplied with the device.
- If “Device not supported” appears even after you perform this procedure, the device is not playable with this unit.
- If “USB current protection active. Device not supported” appears on the TV screen, the device is not playable with this unit because the power consumption of the device is too high.
- This unit cannot read more than two card reader slots at once, though it can recognize up to six slots. The first slot has priority.
- For an external hard disk drive, this unit is compatible with size of 80 GB or less.
- Do not connect devices other than USB mass storage class devices: USB chargers, USB hubs, PCs, etc.

Playing data files

Yamaha and suppliers accepts no liability for the loss of data saved on the USB devices connected to this unit. As a precaution, it is recommended that the files are tested after they have been saved on.

- 1 Connect your USB device to the USB port of this unit (see “USB port” on page 11).
 - ➔ “Press USB mode key to switch device” appears on the TV screen.
- 2 Press **USB**.
 - The reading time may exceed 30 seconds due to the number of files/folders.
 - ➔ The file menu appears on the TV screen.
- 3 Follow the procedure in “Playing data discs (MP3/WMA/JPEG/DivX)” on page 18.

■ To exit from the USB mode

Press **■** to stop playback, and then press **USB**.

Notes

- You cannot access the USB mode while “LOADING” is displayed on the TV screen.
- If you disconnect the USB device or open the disc tray of this unit, the playback mode is automatically switched to the disc mode.
- For DivX, this unit is compatible with a bit rate range of 3 Mbps or less.
- Some files may not work properly depending on the USB device specification.
 - For DivX, the video may freeze shortly or the sound may break in the segments.
 - For MP3, the sound may break in the segments during MP3/JPEG simultaneous playback.
- In this case, record the file at a lower bit rate and/or smaller size so that the file may work properly.
- Copyright-protected files cannot be played.
- This unit can display up to 648 files. However, less than 648 files may be displayed if some files are not playable with this unit.
- If the USB device is partitioned, only the first partition is displayed.
- This unit can play back files of 4 GB in size or less.

Setup Menu

Setup is carried out on the TV screen, enabling you to customize this unit to suit your own particular requirements.

Notes

- Unless stated otherwise, all operations described here are carried out using the supplied remote control.
- To return to the previous menu, press ◀.
- To exit from the menu, press **SET UP**.

General setup menu

- 1 Press **SET UP**.
- 2 Press ◀ / ▶ to select “GENERAL SETUP PAGE”.
- 3 Press **ENTER**.

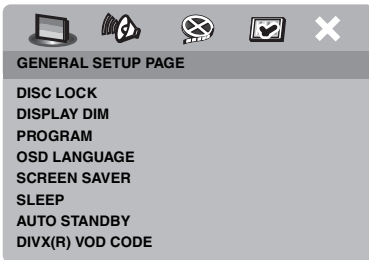

Locking/Unlocking the disc for viewing

Not all discs are rated or coded by the manufacturer of the disc. You can prevent playback of a specific disc by locking the disc. You can lock up to 40 discs on this unit.

- 1 In “GENERAL SETUP PAGE”, press ▲/▼ to highlight [DISC LOCK], and then press ▶.

LOCK

Select this to lock playback of the current disc. Subsequent access to a locked disc requires a six-digit password.

The default password is “000 000” (see “Changing the password” on page 32).

UNLOCK

Select this to unlock the disc and allow future playback.

- 2 Press ▲/▼ to select a setting, and then press **ENTER**.

Dimming the front panel display

You can select different levels of brightness for the front panel display.

- 1 In “GENERAL SETUP PAGE”, press ▲/▼ to highlight [DISPLAY DIM], and then press ▶.

100%

Select this for full brightness.

70%

Select this for medium brightness.

40%

Select this for dimming display.

- 2 Press ▲/▼ to select a setting, and then press **ENTER**.

Programming disc tracks (except MP3/WMA/JPEG/DivX)

You can play back the contents of a disc in the desired order by programming the tracks to be played. You can store up to 20 tracks per disc with a maximum of ten discs.

- 1 In “GENERAL SETUP PAGE”, press ▲/▼ to highlight [PROGRAM], and then press ▶ to select [INPUT MENU].

- 2 Press **ENTER**.
 - The input menu appears on the TV screen.

PROGRAM: TRACK (01-17)

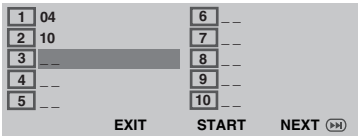

■ To input your favorite tracks/chapters

- 3 Use the **numeric buttons (0-9)** to enter a valid track/chapter number.
- 4 Use **◀ / ▶ / ▲ / ▼** to move the cursor to the next position.
 - If the track/chapter number is more than ten, press **▶▶** to move to the next page, and then proceed with programming.

OR

- Use **◀ / ▶ / ▲ / ▼** to highlight **[NEXT]** on the program menu, and then press **ENTER**.
- 5 Repeat steps **3-4** to input another track/chapter number.

■ To remove a track

- 6 Use **◀ / ▶ / ▲ / ▼** to move the cursor to the track you want to remove.
- 7 Press **ENTER** to remove this track from the program menu.

■ To start program playback

- 8 Use **◀ / ▶ / ▲ / ▼** to highlight **[START]** on the program menu, and then press **ENTER**.
 - Playback starts for the selected tracks in the programmed sequence.

■ To exit from program playback

- 9 Use **◀ / ▶ / ▲ / ▼** to highlight **[EXIT]** on the program menu, and then press **ENTER**.

OSD language

This menu contains various options for the on-screen display (OSD) language. For details, see “Setting the OSD Language” on page 14.

Setting the screen saver

This function is used to turn on or off the screen saver.

- 1 In “GENERAL SETUP PAGE”, press **▲ / ▼** to highlight **[SCREEN SAVER]**, and then press **▶**.

ON

Select this to turn off the TV screen when disc playback is stopped or paused for more than 15 minutes.

OFF

Select this to disable the screen saver function.

- 2 Press **▲ / ▼** to select a setting, and then press **ENTER**.

Setup Menu

Setting the sleep timer

This feature automatically sets this unit to the standby mode after a certain elapsed period.

- 1 In “GENERAL SETUP PAGE”, press ▲/▼ to highlight [SLEEP], and then press ►.
- 2 Press ▲/▼ to select a setting.
 - You can select from 30, 60, 90, 120 and 150 minutes. Select [OFF] to cancel the sleep timer function.
- 3 Press **ENTER**.

Setting the auto standby function

This function is used to turn the auto standby mode on or off when disc playback is stopped for more than 30 minutes.

- 1 In “GENERAL SETUP PAGE”, press ▲/▼ to highlight [AUTO STANDBY], and then press ►.

ON

Select this to set this unit to the standby mode automatically when disc playback is stopped or paused for more than 30 minutes.

OFF

Select this to disable the auto standby function.

- 2 Press ▲/▼ to select a setting, and then press **ENTER**.

Displaying the DivX® VOD registration code

Yamaha provides you with a DivX® VOD (Video On Demand) registration code that allows you to rent and purchase videos using the DivX® VOD service.

For more information, visit <https://vod.divx.com/>.

- 1 In “GENERAL SETUP PAGE”, press ▲/▼ to highlight [DIVX(R) VOD CODE], and then press ►.
 - The registration code appears.
- 2 Press **ENTER** to exit.

Notes

- To purchase or rent the videos from DivX® VOD service at <https://vod.divx.com/>, use the registration code and download the video onto a CD-R for playback on this unit.
- All of the downloaded videos from DivX® VOD can only be played back on this unit.
- For DivX, the time search feature is not available.

Audio setup menu

- 1 Press **SET UP**.
- 2 Press ◀ / ▶ to select “AUDIO SETUP PAGE”.
- 3 Press **ENTER**.

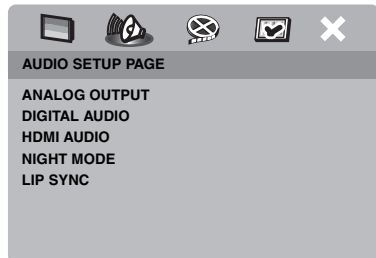

Setting the analog output

Set the analog output to match the playback capability of this unit.

- 1 In "AUDIO SETUP PAGE", press ▲/▼ to highlight [ANALOG OUTPUT], and then press ►.

STEREO

Select this to change channel output to stereo, which only delivers sound from the two front speakers.

LT/RT

Select this if this unit is connected to a Dolby Pro Logic decoder.

- 2 Press ▲/▼ to select a setting, and then press **ENTER**.

Setting the digital output

The [DIGITAL AUDIO] options are: [DIGITAL OUTPUT] and [LPCM OUTPUT].

- 1 In "AUDIO SETUP PAGE", press ▲/▼ to highlight [DIGITAL AUDIO], and then press ►.
- 2 Press ▲/▼ to highlight an option.
- 3 Press ► to open a submenu.

DIGITAL OUTPUT

Set the digital output according to your optional audio component connections.

OFF

Select this to turn off the digital output.

ALL

Select this if you have connected the digital audio output jack to a multi-channel decoder/receiver.

MPEG → PCM

Select this if your receiver is not capable of decoding MPEG audio signals.

PCM ONLY

Select this only if your receiver is not capable of decoding multi-channel audio signals.

LPCM OUTPUT

Select this if you have connected this unit to a PCM-compatible receiver via a digital terminal, such as the coaxial terminal. In this case, you may need to adjust [LPCM OUTPUT].

Discs are recorded at a certain sampling rate. The higher the sampling rate, the better the sound quality.

48KHz

Select this to play back discs recorded at the sampling rate of 48 kHz. All 96 kHz PCM data streams (if available) are converted to the sampling rate of 48 kHz.

96KHz

Select this to play back discs recorded at the sampling rate of 96 kHz. If the 96 kHz disc is copy protected, the digital output is automatically converted to the sampling rate of 48 kHz.

- 4 Press ▲/▼ to select a setting, and then press **ENTER**.

Turning the HDMI audio on/off

When you connect this unit to an HDMI compatible component via the HDMI jack, select to turn on or off the HDMI audio output.

- 1 In "AUDIO SETUP PAGE", press ▲/▼ to highlight [HDMI AUDIO], and then press ►.

ON

Select this to turn on the HDMI audio output.

OFF

Select this to turn off the HDMI audio output.

Setup Menu

Notes

- If you are not using the HDMI audio output, set this to [OFF].
- If the monitor/receiver connected to this unit using HDMI does not support HDMI audio signal input, set this to [OFF].
- This unit can output the following audio signals using HDMI: 32/44.1/48 kHz, 2ch linear PCM signals and bitstream signals (Dolby Digital, DTS and MPEG).
- When audio signals are being output by HDMI-compatible components, digital output signals are muted.
- When [DIGITAL OUTPUT] is set to [OFF] on this unit, HDMI audio is muted even if [HDMI AUDIO] is set to [ON] and an HDMI connection is established between the monitor and receiver.
- When [DIGITAL OUTPUT] is set to [ALL] on this unit, PCM signals are still output if the monitor and receiver only support the PCM format. However, the audio output is muted when audio format plays back the DTS source.

Turning the night mode on/off

In the night mode, high volume output is softened and low volume output is brought upward to an audible level. It is useful when you want to watch your favorite action movie without disturbing others at night.

- 1 In “AUDIO SETUP PAGE”, press ▲/▼ to highlight [NIGHT MODE], and then press ►.

ON

Select this to level out the volume. This feature is only available for movies with the Dolby Digital mode.

OFF

Select this when you want to enjoy the full dynamic range of surround sound.

- 2 Press ▲/▼ to select a setting, and then press **ENTER**.

Setting the lip synchronization

This feature allows you to delay the sound output in order to synchronize it with the video image. This may be necessary when you use certain LCD monitors or projectors.

- 1 In “AUDIO SETUP PAGE”, press ◀ / ▶ to highlight [LIP SYNC], and then press ►.
- 2 Press ◀ / ▶ to adjust the delay time (between 00 ms and 200 ms), and then press **ENTER**.

Video setup menu

- 1 Press **SET UP**.
- 2 Press ◀ / ▶ to select “VIDEO SETUP PAGE”.
- 3 Press **ENTER**.

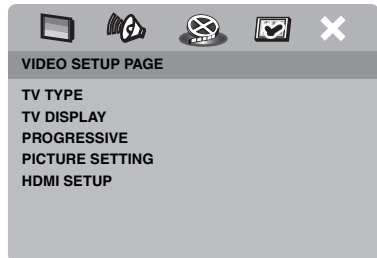

TV type

This menu contains the options for selecting the color system that matches your TV. For details, see “Setting a color system for your TV” on page 13.

Setting the TV display

Set the aspect ratio of this unit to match your TV. The format you select must be available on the disc. Otherwise, the TV display setting will not affect the picture during playback.

- 1 In "VIDEO SETUP PAGE", press ▲/▼ to highlight [TV DISPLAY], and then press ►.
- 2 Press ▲/▼ to highlight one of the following options.

4:3 PAN SCAN

Select this if the aspect ratio of your TV is 4:3 and you want both sides of the picture to be trimmed or formatted to fit your TV screen.

4:3 LETTER BOX

Select this if the aspect ratio of your TV is 4:3. In this case, a wide picture with black bands on the upper and lower portions of the TV screen are displayed.





16:9

Select this if you have a widescreen TV.



- 3 Select an item, and then press **ENTER**.

■ The relationship between the setting of this unit and the TV display

When the aspect ratio of your TV is 4:3:

Setting	Playback disc	TV display	
4:3 PAN SCAN	16:9		*1
	4:3		
4:3 LETTER BOX	16:9		
	4:3		

When the aspect ratio of your TV is 16:9 (widescreen):

Setting	Playback disc	TV display	
16:9	16:9		
	4:3		*2

*1: If the disc is not assigned to playback in panscan, it is played in letterbox.

*2: The side of the picture may be stretched depending on the TV. In this case, check the screen size and aspect ratio of your TV.

Turning the progressive scan function on/off

This feature is only available if you have connected this unit to a progressive scan TV through the component video jacks (see "Component video jacks <A>" on page 9).

- 1 In "VIDEO SETUP PAGE", press ▲/▼ to highlight [PROGRESSIVE], and then press ►.

OFF

Select this to disable the progressive scan function.

ON

Select this to enable the progressive scan function.

- 2 Press ▲/▼ to select a setting, and then press **ENTER**.

Setup Menu

Notes on activating progressive scan:

- Ensure that your TV is equipped with progressive scan.
- Connect using a component video cable.
- When making HDMI connections, you cannot select [PROGRESSIVE].

CONSUMERS SHOULD NOTE THAT NOT ALL HIGH DEFINITION TELEVISION SETS ARE FULLY COMPATIBLE WITH THIS PRODUCT AND MAY CAUSE ARTIFACTS TO BE DISPLAYED IN THE PICTURE. IN CASE OF 525 OR 625 PROGRESSIVE SCAN PICTURE PROBLEMS, IT IS RECOMMENDED THAT THE USER SWITCH THE CONNECTION TO THE "STANDARD DEFINITION" OUTPUT. IF THERE ARE QUESTIONS REGARDING OUR VIDEO MONITOR COMPATIBILITY WITH THIS MODEL 525P AND 625P DVD PLAYER, PLEASE CONTACT OUR CUSTOMER SERVICE CENTER.

This unit is compatible with the complete line of Yamaha products, including the projectors DPX-1300, DPX-830 and the plasma monitor PDM-4220.

Adjusting picture settings

This unit comes with three predefined sets of picture color settings and one personal setting that you can define yourself.

- 1 In "VIDEO SETUP PAGE", press ▲/▼ to highlight [PICTURE SETTING], and then press ►.

STANDARD

Select this for the standard picture setting.

BRIGHT

Select this to make the TV picture brighter.

SOFT

Select this to make the TV picture softer.

PERSONAL

Select this to personalize your picture color by adjusting the brightness, contrast, tint and color (saturation).

- 2 Press ▲/▼ to select a setting, and then press **ENTER**.
- 3 If you select [PERSONAL] in step 1, proceed to steps 4-7.
→ The "PERSONAL PICTURE SETUP" menu appears.

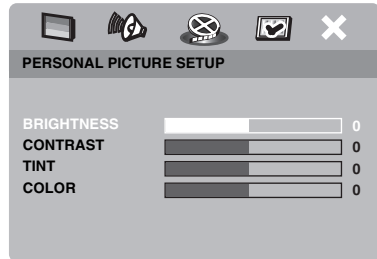

- 4 Press ▲/▼ to select one of the following options.

BRIGHTNESS

Increase or decrease the value to brighten or dim the picture. Zero (0) is the average brightness setting value.

CONTRAST

Increase or decrease the value to sharpen or dull the picture. Zero (0) is the average contrast setting value.

TINT

Increase or decrease the value to darken or lighten the picture. Zero (0) is the average tint setting value.

COLOR

Increase or decrease the value to enhance or fade the picture. Zero (0) is the average color setting value.

- 5 Press ◀/▶ to adjust the setting that best suits your personal preference.
- 6 Repeat steps 4-5 to adjust other color features.
- 7 Press **ENTER**.

Note

All picture settings are not available for HDMI output.

Setting the HDMI video

When you connect this unit to an HDMI compatible component via the HDMI jack, select the following video output settings depending on the connected component.

- 1 In “VIDEO SETUP PAGE”, press ▲/▼ to highlight [HDMI SETUP], and then press ►.
- 2 Press ▲/▼ to highlight an option.
- 3 Press ► to enter a submenu.

WIDE SCREEN FORMAT

Set the aspect ratio of the projected images on the screen. This feature is only available when making HDMI connections and [TV DISPLAY] is set to [16:9] (see page 27).

SUPERWIDE

Select to display a 4:3 image on the 16:9 screen with non-linear stretching (center position of screen is stretched less than the sides). This feature is not available when the resolution is 480p or 576p.

4:3 PILLAR BOX

Select to display a 4:3 image on the 16:9 screen without stretching. When playing a disc recorded in the 16:9 image, the image is displayed in its original aspect ratio (16:9) without pillar boxes.

OFF

No aspect ratio adjustment is made when this option is selected.

HDMI VIDEO

Set the resolution depending on the monitor you are using.

480P

480 progressive-scan video

576P

576 progressive-scan video

720P

720 progressive-scan video

1080I

1080 interlace video

AUTO

The resolution is automatically selected to match the monitor you are using.

Notes

- For settings other than [AUTO], HDMI video signals may not be output properly if a resolution output setting is not supported by the HDMI component you are using. In that case, follow the steps below to return to the initial setting.
 - 1 Press **OPEN/CLOSE (△)** on the front panel to open the disc tray.
 - 2 Press ◀.
 - 3 Press **SUBTITLE**.
 Do not perform this operation while playing back a disc on this unit.
- You cannot set [TV TYPE] and [PROGRESSIVE] when making HDMI connections.
- When disconnecting the HDMI cable, the setting of [TV TYPE] may be changed. If the component video, S-video or composite video signal is not output correctly, see “Troubleshooting” on page 34 to set the correct TV type again.

HD JPEG

This unit can display High-Definition JPEG images when connecting to an HDMI component.

ON

Displays JPEG pictures with high quality.

OFF

Displays JPEG pictures with standard quality.

Notes

- You can select [HD JPEG] when the HDMI video signals with 720p or 1080i are output.
- When [HD JPEG] is set to [ON] and HD JPEG pictures are displayed, video signals other than HDMI signals are not output.
- You cannot select [HDMI VIDEO] and [HD JPEG] when HD JPEG pictures are displayed.

Setup Menu

Preference setup menu

- 1 Press **■** twice to stop playback (if necessary), and then press **SET UP**.
- 2 Press **◀ / ▶** to select “PREFERENCE PAGE”.
- 3 Press **ENTER**.

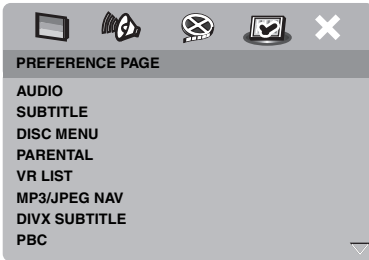

Audio, subtitle and disc menu

These menus contain various language options for the audio, subtitles and disc menus recorded on the DVD-Video. For details, see “Setting the audio, subtitle and disc menu languages (DVD-Video only)” on page 14.

Restricting playback with parental control

Some DVDs may have a parental level assigned to the complete disc or to certain scenes on the disc. This feature lets you set a playback limitation level.

The rating levels are from 1 to 8 and are country dependent. You can prohibit playback of certain discs that are not suitable for your children or play certain discs in alternative scenes.

- 1 In “PREFERENCE PAGE”, press **▲/▼** to highlight [PARENTAL], and then press **▶**.

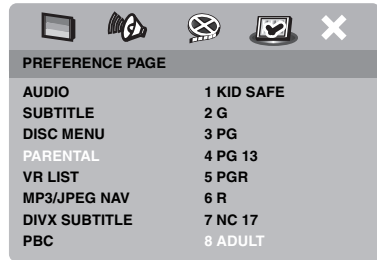

- 2 Press **▲/▼** to highlight a rating level for the inserted disc, and then press **ENTER**.
 - To disable parental controls and have all discs play, select [8 ADULT].
- 3 Use the **numeric buttons (0-9)** to enter the six-digit password (see “Changing the password” on page 32).
 - DVD discs that are rated above the level you selected do not play unless you enter your six-digit password.

Note

Some DVD discs are not encoded with a rating though the movie rating may be printed on the disc cover. The rating level feature does not work for such discs.

Selecting playback of VR format

There are two ways to play back a disc in VR (Video Recording) format: ORIGINAL and PLAY LIST. This feature is not available with non-VR format discs.

- 1 In “PREFERENCE PAGE”, press **▲/▼** to highlight [VR LIST], and then press **▶**.

ORIGINAL LIST

Select this to play the originally recorded titles on the disc.

PLAY LIST

Select this to play the edited version of the disc. This feature is only available when a play list has been created.

2 Press ▲/▼ to highlight a setting, and then press **ENTER**.

■ To play back a disc in VR format

3 Press **SET UP** to close the setup menu.

4 Press ►/|| to begin to play back the disc with the setting you selected.

Selecting the MP3/JPEG menu

MP3/JPEG navigator can be set only if the disc was recorded with a menu. It allows you to select different display menus for easy navigation.

1 In “PREFERENCE PAGE”, press ▲/▼ to highlight [MP3/JPEG NAV], and then press ►.

WITHOUT MENU

Select this to display all the files contained in the MP3/Picture CD.

WITH MENU

Select this to display only the folder menu of the MP3/Picture CD.

2 Press ▲/▼ to select a setting, and then press **ENTER**.

Displaying DivX external subtitle files

The font sets listed below are available for DivX external subtitle files. This setting allows you to see the proper font set on-screen to match the subtitle file.

1 In “PREFERENCE PAGE”, press ▲/▼ to highlight [DIVX SUBTITLE], and then press ►.

GROUP1:

Albanian (sq), Basque (eu), Catalan (ca), Danish (da), Dutch (nl), English (en), Faroese (fo), Finnish (fi), French (fr), German (de), Icelandic (is), Irish (ga), Italian (it), Norwegian (no), Portuguese (pt), Rhaeto-Romanic (rm), Scottish (gd), Spanish (es), Swedish (sv)

GROUP2:

Albanian (sq), Croatian (hr), Czech (cs), Hungarian (hu), Polish (pl), Romanian (ro), Slovak (sk), Slovenian (sl)

GROUP3:

Bulgarian (bg), Byelorussian (be), Macedonian (mk), Russian (ru), Serbian (sr), Ukrainian (uk)

GROUP4:

Hebrew (iw), Yiddish (ji)

GROUP5:

Turkish (tr)

2 Press ▲/▼ to select a group, and then press **ENTER**.

Notes

- Some discs cannot be played depending on disc characteristics or recording conditions.
- Some external subtitle files may be displayed incorrectly or not at all.
- For external subtitle files, the following subtitle format filename extensions are supported (note that these files are not shown within the disc navigation menu): .srt, .sub, .ssa, .smi
- The filename of the movie file has to be repeated at the beginning of the filename for the external subtitle file.
- The number of external subtitle files that can be switched for the same movie file is limited to a maximum of ten.

Setup Menu

Selecting the PBC (playback control) function

You can set playback control (PBC) to on or off. This function is available only on Video CD 2.0 with the playback control (PBC) feature.

- 1 In “PREFERENCE PAGE”, press ▲/▼ to highlight [PBC], and then press ►.

ON

Select this to display a disc menu.

OFF

Select this to not display a disc menu. Playback starts from the beginning of a disc.

- 2 Press ▲/▼ to select a setting, and then press **ENTER**.

Note

You can also use the MENU button on the remote control to turn on or off the playback control (PBC) function (see “Using the playback control (PBC) menu” on page 18).

Changing the password

The same password is used for both parental control and disc lock. Enter your six-digit password when prompted on the screen. The default password is 000 000.

- 1 In “PREFERENCE PAGE”, press ▲/▼ to highlight [PASSWORD], and then press ► to select [CHANGE].

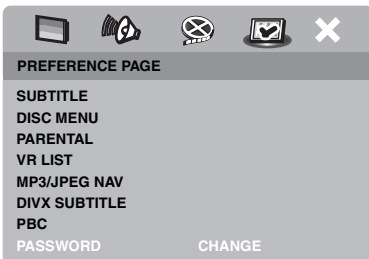

- 2 Press **ENTER** to enter the “Password Change Page”.

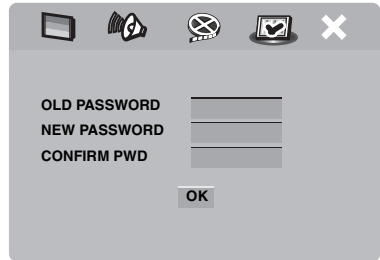

- 3 Use the **numeric buttons (0-9)** to enter your old six-digit password.
 - When doing this for the first time, enter “000 000”.
 - If you forget your old six-digit password, enter “000 000”.
- 4 Enter the new six-digit password.
- 5 Enter the new six-digit password again to confirm the password.
- 6 Press **ENTER** to confirm your new password.
 - The new six-digit password is now valid.

Resetting the system

You can reset all options and your personal settings to the initial factory settings, excluding your password for [PARENTAL] and [DISC LOCK].









- 1 In “PREFERENCE PAGE”, press ▲/▼ to highlight [DEFAULT], and then press ► to select [RESET].
- 2 Press **ENTER**.
 - All settings are reset to the initial factory settings.

These codes can be used to select other languages. This does not affect the options in “AUDIO”, “SUBTITLE” or “DISC MENU”.

Abkhazian	6566	Gaelic	7168	Macedonian	7775	Sardinian	8367
Afar	6565	Gallegan	7176	Malagasy	7771	Scottish Gaelic	7168
Afrikaans	6570	Georgian	7565	Malay	7783	Serbian	8382
Albanian	8381	German	6869	Malayalam	7776	Shona	8378
Amharic	6577	Gikuyu	7573	Maltese	7784	Sindhi	8368
Arabic	6582	Greek	6976	Manx	7186	Sinhalese	8373
Armenian	7289	Guarani	7178	Maori	7773	Slovak	8375
Assamese	6583	Gujarati	7185	Marathi	7782	Slovenian	8376
Avestan	6569	Hausa	7265	Marshallese	7772	Somali	8379
Aymara	6589	Hebrew	7269	Moldavian	7779	Sotho, Southern	8384
Azerbaijani	6590	Herero	7290	Mongolian	7778	South Ndebele	7882
Bashkir	6665	Hindi	7273	Nauru	7865	Spanish	6983
Basque	6985	Hiri Motu	7279	Navaho	7886	Sundanese	8385
Belarusian	6669	Hungarian	7285	Navajo	7886	Swahili	8387
Bengali	6678	Icelandic	7383	Ndebele, North	7868	Swati	8383
Bihari	6672	Ido	7379	Ndebele, South	7882	Swedish	8386
Bislama	6673	Indonesian	7368	Ndonga	7871	Tagalog	8476
Bokmål, Norwegian	7866	Interlingua (International)	7365	Nepali	7869	Tahitian	8489
Bosnian	6683	Interlingue	7369	Northern Sami	8369	Tajik	8471
Breton	6682	Inuktitut	7385	North Ndebele	7868	Tamil	8465
Bulgarian	6671	Inupiaq	7375	Norwegian	7879	Tatar	8484
Burmese	7789	Irish	7165	Norwegian Bokmål	7866	Telugu	8469
Castilian	6983	Italian	7384	Norwegian Nynorsk	7878	Thai	8472
Catalan	6765	Japanese	7465	Nyanja	7889	Tibetan	6679
Chamorro	6772	Javanese	7486	Nynorsk, Norwegian	7878	Tigrinya	8473
Chechen	6769	Kalaallisut	7576	Occitan (post 1500)	7967	Tonga (Tonga Islands)	8479
Chewa	7889	Kannada	7578	Old Bulgarian	6785	Tsong	8483
Chichewa	7889	Kashmiri	7583	Old Church Slavonic	6785	Tswana	8478
Chinese	9072	Kazakh	7575	Old Slavonic	6785	Turkish	8482
Chuang	9065	Khmer	7577	Oriya	7982	Turkmen	8475
Church Slavic	6785	Kikuyu	7573	Oromo	7977	Twi	8487
Church Slavonic	6785	Kinyarwanda	8287	Ossetian	7983	Uighur	8571
Chuvash	6786	Kirghiz	7589	Ossetic	7983	Ukrainian	8575
Cornish	7587	Komi	7586	Pali	8073	Urdu	8582
Corsican	6779	Korean	7579	Panjabi	8065	Uzbek	8590
Croatian	7282	Kuanyama	7574	Persian	7065	Vietnamese	8673
Czech	6783	Kurdish	7585	Polish	8076	Volapük	8679
Danish	6865	Kwanyama	7574	Portuguese	8084	Walloon	8765
Dutch	7876	Lao	7679	Provençal	7967	Welsh	6789
Dzongkha	6890	Latin	7665	Pushto	8083	Wolof	8779
English	6978	Latvian	7686	Quechua	8185	Xhosa	8872
Esperanto	6979	Letzeburgesch	7666	Raeto-Romance	8277	Yiddish	8973
Estonian	6984	Limburgan	7673	Romanian	8279	Yoruba	8979
Faroese	7079	Limburger	7673	Rundi	8278	Zhuang	9065
Fijian	7074	Limburgish	7673	Russian	8285	Zulu	9085
Finnish	7073	Lingala	7678	Samoan	8377		
French	7082	Lithuanian	7684	Sango	8371		
Frisian	7089	Luxembourgish	7666	Sanskrit	8365		

Troubleshooting

Refer to the chart below when this unit does not function properly. If the problem you are experiencing is not listed below or if the instruction below does not help, set this unit to the standby mode, disconnect the power cable, and contact the nearest authorized Yamaha dealer or service center.

Problem	Solution
No power	Connect the AC power cable properly.
	Press STANDBY/ON on the front panel to turn on the power.
No picture	Refer to the manual supplied with your TV to select the video input channel correctly. Change the TV channel until you see the DVD screen.
	Turn on your TV.
	Check the video connection.
	Video signals other than HDMI signals are not output when HD JPEG pictures are displayed (see “HD JPEG” on page 29).
No picture is displayed when you make HDMI connections (using the HDMI jacks)	Follow the steps below to change the [HDMI VIDEO] to [AUTO]. <ol style="list-style-type: none"> 1. Press OPEN/CLOSE () on the front panel or press and hold  on the remote control to open the disc tray. 2. Press  on the remote control. 3. Press SUBTITLE on the remote control.
No picture is displayed when you do not use progressive scan connections (using the component video jacks)	Follow the steps below to turn off the progressive scan. <ol style="list-style-type: none"> 1. Press OPEN/CLOSE () on the front panel or press and hold  on the remote control to open the disc tray. 2. Press  on the remote control. 3. Press ZOOM on the remote control to deactivate the progressive scan.
Completely distorted picture or black/white picture or no picture	Check that the disc is compatible with this unit (see “Playable disc formats” on page 3).
	Check that the TV type of this unit is set to match that of the disc and your TV (see “Setting a color system for your TV” on page 13). Follow the steps below to change the setting of [TV TYPE]. <ol style="list-style-type: none"> 1. Press OPEN/CLOSE () on the front panel or press and hold  on the remote control to open the disc tray. 2. Press  on the remote control. 3. Press AUDIO on the remote control.
Distorted picture	Occasionally, a small amount of picture distortion may appear depending on the disc being played back. This is not a malfunction.
The screen size looks unnatural, or the caption is displayed only partially on the TV monitor or is not displayed at all	Check that the TV setting of this unit matches the screen size of your TV (see “Setting the TV display” on page 27).
	Change the screen size and the aspect ratio of your TV.

Problem	Solution
No sound or distorted sound	Adjust the volume.
	Check that the speakers are connected correctly.
	For MP3/WMA, check that the sampling rate and bit rate are compatible with this unit (see “Specifications” on page 39).
No audio at digital output	Check the digital connections.
	If you are playing a DTS source, check that your receiver can decode DTS, and that [DIGITAL OUTPUT] is set to [ALL] (see page 25).
	If you are playing an MPEG-2 source, check that your receiver can decode MPEG-2. Otherwise, check that [DIGITAL OUTPUT] is set to [MPEG → PCM] (see page 25).
	Check that the audio format of the selected audio language matches your receiver capabilities.
Disc does not play	The CD-R/RW, DVD+R/RW/R DL and DVD-R/RW/R DL must be finalized.
	Check that the disc label is facing up.
	Check whether the disc is defective by trying another disc.
	If you have recorded a JPEG, MP3 or WMA disc yourself, check that your disc contains at least ten JPEG picture files or five MP3/WMA music tracks.
	For MP3/WMA, check that the sampling rate and bit rate are compatible. For JPEG, check that the resolution is compatible (see “Specifications” on page 39).
	Check the region code (see “Region codes” on page 3).
Picture freezes momentarily during playback	Check the disc for fingerprints/scratches and clean it with a soft cloth wiping from center to edge.
This unit does not respond to the remote control	Aim the remote control directly at the remote control sensor on the front panel.
	Reduce the distance of the remote control from this unit.
	Replace the batteries in the remote control.
	Reinsert the batteries with their polarities (+/- signs) as indicated.
Buttons do not work	To completely reset this unit, unplug the AC cord from the AC outlet for 5-10 seconds.
This unit does not respond to some operating commands during playback	Some operations may not be permitted by the disc. Refer to the instructions of the disc jacket.
	The ▲/▼ key is not available during HD JPEG playback.
This unit cannot read CD or DVD	Use a commonly available CD/DVD lens cleaner to clean the lens before sending this unit for repair.

Troubleshooting

Problem	Solution
“NO DISC” appears in the front panel display	Check that the disc is placed in the disc tray correctly.
“UN DISC” appears in the front panel display	The disc being loaded is not supported by this unit. Check the disc type (see “Playable disc formats” on page 3).
Menu items cannot be selected	Press ■ twice on the remote control before selecting the setup menu.
	Depending on the disc availability, some menu items cannot be selected.
	To select [HD JPEG], check that the HDMI component is connected correctly and the HDMI video signals with 720p or 1080i are output.
HD JPEG pictures cannot be displayed	Check that [HD JPEG] is set to [ON] (see page 29).
	The disc reading time may exceed 30 seconds.
	MP3 music and HD JPEG pictures cannot be played simultaneously.
No sound during DivX movie playback	The audio code may not be supported by this unit.
The USB device cannot be recognized	Check that the USB device is connected correctly.
	Some devices may not work even if they are USB mass storage class devices.
	Set this unit to the standby mode, and then turn it on again.
	Disconnect the device when this unit is in the standby mode, then connect it again and turn on this unit.
	Connect the AC adapter if the adapter is supplied with the device.
	If “Device not supported” appears on the TV screen, check whether the device is supported by this unit (see “Supported USB devices” on page 21).
	If “USB current protection active. Device not supported” appears on the TV screen, the device is not playable with this unit (see page 21).

■ Analog

Sound that has not been converted into numerical values. Analog sound varies, while digital sound has specific numerical values. These jacks send audio through two channels, the left and right.

■ Aspect ratio

The ratio of vertical and horizontal sizes of a displayed image. The horizontal vs. vertical ratio of conventional TVs is 4:3, and that of widescreens is 16:9.

■ Audio output jacks

Jacks on the back of the DVD player that send audio to another system (TV, Stereo, etc.).

■ Bit rate

The amount of data used to hold a given length of music, measured in kilobits per seconds, or kbps. Or, the speed at which you record. Generally, the higher the bit rate, or the higher the recording speed, the better the sound quality. However, higher bit rates use more space on a Disc.

■ Chapter

Sections of a picture or a music piece on a DVD that are smaller than titles. A title is composed of several chapters. Each chapter is assigned a chapter number enabling you to locate the chapter you want.

■ Component video output jacks

Jacks on the back of the DVD player that send high-quality video to a TV that has component video input jacks (R/G/B, Y/Pb/Pr, etc.).

■ Disc menu

A screen display prepared for allowing selection of images, sounds, subtitles, multi-angles, etc. recorded on a DVD.

■ Digital

Sound that has been converted into numerical values. Digital sound is available when you use the digital audio output jacks. These jacks send audio through multiple channels, instead of just two channels as analog does.

■ DivX

DivX is a popular media technology created by DivX, Inc. DivX media files contain highly compressed video with high visual quality while maintaining a relatively small file size. DivX files can also include advanced media features like menus, subtitles, and alternate audio tracks. Many DivX media files are available for download online, and you can create your own using your personal content and easy-to-use tools from DivX.com.

■ DivX Ultra

DivX Ultra Certified products provide enhanced playback of advanced media features supported by the DivX Media Format. Key features include interactive video menus, subtitles, alternate audio tracks, video tags and chapter points.

■ DMF (DivX Media Format)

The DivX Media Format supports advanced media features, adding controls for an interactive media experience: interactive video menus, chapter points, multi-language subtitles and alternate audio tracks.

■ Dolby Digital

A surround sound system developed by Dolby Laboratories containing up to six channels of digital audio (front left and right, surround left and right, center and subwoofer).

■ DTS

Digital Theatre Systems. This is a surround sound system, but it is different from Dolby Digital. The formats were developed by different companies.

■ HDMI

HDMI (High-Definition Multimedia Interface) is the first industry-supported, uncompressed, all-digital A/V (audio/video) interface. Providing an interface between any A/V source (such as a set-top box or A/V receiver) and an audio/video monitor (such as a digital television-DTV), HDMI supports standard, enhanced or high-definition video as well as multi-channel digital audio using a single cable. HDMI transmits all ATSC HDTV standards and supports 8-channel digital audio, with bandwidth extra to accommodate future enhancements and requirements.

When used in combination with HDCP (High-bandwidth Digital Content Protection), HDMI provides a secure audio/video interface that meets the security requirements of content providers and system operations. For further information on HDMI, visit the HDMI website at "www.hdmi.org/".

■ HDCP

HDCP (High-bandwidth Digital Content Protection) developed by Intel corporation, is a method to encrypt digital video and audio data for purpose of content protection. For further information on HDCP, visit the HDCP website at "www.digital-cp.com".

■ HD JPEG

HD (High-Definition) JPEG provides images in their enhanced resolution via HDMI connection.

Glossary

■ Interactive menu

Interactive video menus offer unprecedented convenience and control so you can quickly navigate between various scenes or bonus features, and select from audio track and subtitle options.

■ JPEG

A very common digital still picture format. A still-picture data compression system proposed by the Joint Photographic Expert Group, which features small decrease in image quality in spite of its high compression ratio.

■ MP3

A file format with a sound data compression system. "MP3" is the abbreviation of Motion Picture Experts Group 1 (or MPEG-1) Audio Layer 3. By using MP3 format, one CD-R or CD-RW can contain about ten times as much data as a regular CD can.

■ Parental control

A function of the DVD to limit playback of the disc by the age of the users according to the limitation level in each country. The limitation varies from disc to disc; when it is activated, playback will be prohibited if the software's level is higher than the user-set level.

■ PCM (Pulse Code Modulation)

A system for converting analog sound signals to digital signals for later processing, with no data compression used in conversion.

■ Playback control (PBC)

Refers to the signal recorded on video CDs or SVCDs for controlling reproduction. By using menu screens recorded on a Video CD or SVCD that supports PBC, you can enjoy interactive-type software as well as software having a search function.

■ Play list

A list of selected titles to be played back in a specific order. This option is only available with VR format and must be created beforehand.

■ Progressive scan

It displays all the horizontal lines of a picture at one time, as a signal frame. This system can convert the interlaced video from DVD into progressive format for connection to a progressive display. It dramatically increases the vertical resolution.

■ Region code

A system for allowing discs to be played back only in the region designated beforehand. This unit will only play discs that have compatible region codes. You can find the region code of your unit by looking on the product label. Some discs are compatible with more than one region (or ALL regions).

■ S-video

Produces a clear picture by sending separate signals for the luminance and the color. You can use S-video only if your TV has S-video input jack.

■ Surround

A system for creating realistic three dimensional sound fields full of realism by arranging multiple speakers around the listener.

■ Title

The longest section of a picture or music feature on DVD, music, etc., in video software, or the entire album in audio software. Each title is assigned a title number enabling you to locate the title you want.

■ Video output jack

Jack on the back of the DVD player that sends video to a TV.

■ VR (Video Recording) format

A format which enables you to create a DVD disc that can be extensively re-edited.

PLAYABLE DISC FORMATS

- DVD-Video
- DVD-R, DVD-RW, DVD-R DL
- DVD+R, DVD+RW, DVD+R DL
- Video CD, SVCD
- CD
- PICTURE CD
- CD-R, CD-RW
- MP3 (ISO 9660)..... fs 32, 44.1, 48 kHz /
96, 128, 256, 320 kbps (CBR only)
- WMA.....fs 44.1 kHz, 62–192 kbps (CBR only) /
fs 48 kHz, 128–192 kbps (CBR only)
- DivX
- JPEG..... 3072 x 2048 dpi or less

VIDEO PERFORMANCE

- Video (CVBS) output.....1 Vpp into 75 ohm
- S-Video output Y: 1 Vpp into 75 ohm
C: 0.3 Vpp into 75 ohm
- Component video output.....Y: 1 Vpp into 75 ohm
Pb Pr: 0.7 Vpp into 75 ohm
- RGB (Scart) output (U.K. and Europe models only)
..... Y: 0.7 Vpp into 75 ohm

AUDIO FORMAT

- Digital
Dolby Digital, DTS, MPEG..... Compressed digital
PCM..... fs 44.1, 48, 96 kHz / 16, 20, 24 bits
- Analog soundStereo

AUDIO PERFORMANCE

- DA Converter.....24 bit
- Signal-Noise (1 kHz) 105 dB
- Dynamic range (1 kHz)..... 97 dB
- DVDfs 96 kHz, 2 Hz-44 kHz /
fs 48 kHz, 2 Hz-22 kHz
- SVCDfs 48 kHz, 2 Hz-22 kHz /
fs 44.1 kHz, 2 Hz-20 kHz
- CD, VCD.....fs 44.1 kHz, 2 Hz-20 kHz
- Distortion and Noise (1 kHz) 0.0035%

MULTIMEDIA APPLICATIONS

- Connections..... USB mass storage class device
- Playback formats (USB device)
MP3..... fs 32, 44.1, 48 kHz /
96, 128, 256, 320 kbps (CBR only)
WMA.....fs 44.1 kHz, 62–192 kbps (CBR only) /
fs 48 kHz, 128–192 kbps (CBR only)
DivX..... 3 Mbps or less
JPEG 3072 x 2048 dpi or less

TV STANDARD

- Number of linesPAL: 625, NTSC: 525
- Vertical frequency.....PAL: 50 Hz, NTSC: 60 Hz
- Playback..... Multistandard (PAL/NTSC)

CONNECTIONS

- Video output RCA/Phono x 1 (yellow)
- S-video output..... Mini DIN, 4 pins x 1
- Component video output
Y output RCA/Phono x 1 (green)
Pb output..... RCA/Phono x 1 (blue)
Pr output..... RCA/Phono x 1 (red)
- SCART (U.K. and Europe models only)
Euroconnector x 1
- Audio output (L+R) RCA/Phono x 1 pair (white/red)
- Digital output
Coaxial..... RCA/Phono x 1
(IEC60958 for CDDA, LPCM /
IEC61937 for MPEG 1/2, Dolby Digital, DTS)
HDMI..... Type A x 1
- USB Type A x 1
- Remote Control
Input..... ϕ 3.5 mm mini jack x 1
Output ϕ 3.5 mm mini jack x 1

CABINET

- Dimensions (W x D x H)435 x 310 x 51 mm
- Weight.....Approx. 2.6 kg

POWER SUPPLY

- Power inlet
U.S.A. and Canada models..... AC 120 V, 60 Hz
U.K. and Europe models..... AC 230 V, 50 Hz
Australia, Asia, Central and South America models
..... AC 110-240 V, 50 Hz/60 Hz
Korea model AC 110-240 V, 60 Hz
- Power consumption..... Approx. 14 W
- Standby power consumption..... Less than 1 W

LASER

Type	Semiconductor laser GaAlAs
Wave length	650 nm (DVD) 780 nm (VCD/CD)
Output Power	7 mW (DVD) 10 mW (VCD/CD)
Beam divergence	60 degrees

Specifications are subject to change without prior notice.

注意：在操作本机之前请阅读此部分。

- 1 要确保最好的性能，请仔细阅读此手册。请将它保存在安全的地方以备将来参考。
- 2 请将本机放在通风良好，凉爽并且干燥，干净的地方，至少保持其上方，后方及两侧留出 2.5 厘米的空间，以确保通风良好，应远离直射阳光，热源，振动，灰尘，潮湿或寒冷的地方。
- 3 请将本机远离其它电子设备，马达或变压器以避免嗡嗡声。
- 4 请勿使本机经受过从冷到热的突然温度改变，勿将本机放置于高湿度的环境中（例如有加湿器的房间）以防止本机内部发生结露，否则可能导致触电，火灾，损害本机，或人体伤害。
- 5 请避免在外部物体可能落入本机的地方或本机可能遭遇液体滴落或飞溅的地方安装本机。在本机的顶部，请勿放置：
 - 其它组件机，因为它们可能对本机表面造成损坏或者导致变色。
 - 燃烧物体（例如蜡烛），因为它们可能导致火灾，对本机造成损害或造成人体伤害。
 - 内部装有液体的容器，因为它们可能会掉落并且液体可能引起用户触电并且会损坏本机。
- 6 为了不间断热量散发，请勿使用报纸，桌布，窗帘等遮盖本机。如果本机内的温度升高，可能会引起火灾，损坏本机或导致人体伤害。
- 7 在所有的连接完成之前请勿将本机插头插入墙上插座。
- 8 请勿上下倒置操作本机。它可能过热，并极有可能导致损坏。
- 9 请勿在开关，旋钮或导线上用力。
- 10 当将电源线从墙上插座断开时，请抓住插头；请勿拖拉导线。
- 11 请勿使用化学溶剂清洁本机；这可能损坏机壳涂层。请使用洁净的干布。
- 12 只能使用本机规定的电压。在本机上使用比规定值高的电压是危险的并可能导致火灾，损坏本机或造成人体伤害。Yamaha 将不对由于在本机上使用非规定电压而造成的任何损害负责。
- 13 请勿尝试修改或修理本机。当需要任何维修时请联系专业 Yamaha 维修人员。不能以任何理由打开机壳。
- 14 当准备长时间（例如休假）不使用本机时，请将 AC 电源线从墙上插座断开。
- 15 对通常的操作错误，在断定本机出故障之前，请务必先阅读“故障排除”一节。
- 16 在搬动本机之前，请按 STANDBY/ON 以将本机设置为待机模式；并将 AC 电源插头从墙上插座断开。
- 17 将本机靠近电源插座安装以便电源的接插。
- 18 电池不能置于高热环境，比如火或直射日光等。

即使本机自身关闭，只要本机还与墙上插头连接，它就未从 AC 电源断开。此状态被称为待机模式。在此状态下，本机被设定为仅消耗非常少量的电力。

警告

要减少火灾或触电的危险，请勿将本机暴露于雨中或湿气中。

注意

使用此处指定外的控制或调节以及进行指定外的操作都有可能引起有害的辐射暴露。

激光安全

本机使用激光。因为可能会伤害眼睛，仅可由具有资格的维修人员拆卸罩盖或试图对本装置进行维修服务。

危险

打开本机时，机器会放出可见激光射线。要避免激光光束直接照射到眼睛上。

在插上本机的交流电源时，不要将眼睛对着打开的托盘或装置的其他开口，并且不要往装置内部窥视。

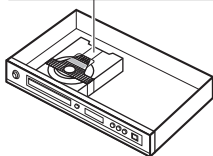
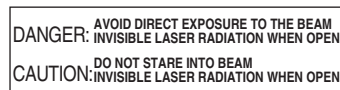
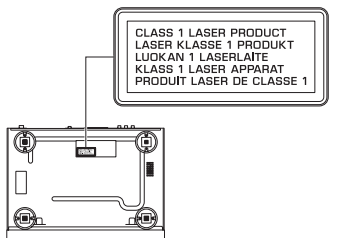

前言	3	播放操作	15
提供的配件	3	基本操作	15
区域码	3	选择曲目 / 章节	15
可播放碟片格式	3	向后 / 向前搜索	15
清洁碟片	4	反复 / 随机功能	15
专利信息	4	反复 / 随机播放	15
		反复播放章节 / 曲目内的一段	16
功能综述	5	视频播放操作 (DVD/VCD/SVCD)	16
前部面板	5	使用碟片菜单	16
后部面板	6	以慢动作播放	16
遥控器	7	放大 / 缩小图像	16
		从最后停止点重新开始播放	16
		使用在屏显示 (OSD)	17
连接	8	特殊的 DVD 功能	18
连接时的注意事项	8	标题的播放	18
音频连接	8	选择音频语言 / 格式和字幕语言	18
数码连接	8	特殊的 VCD/SVCD 功能	18
模拟连接	8	使用播放控制 (PBC) 菜单	18
视频连接	9	播放数据碟片 (MP3/WMA/JPEG/DivX)	18
分量视频插孔 <A>	9	选择一个文件夹和曲目 / 文件	19
S- 视频插孔 	9	特殊的图像碟片功能	19
复合视频插孔 <C>	9	使用预览功能	19
HDMI 连接	10	放大 / 缩小图像	19
HDMI 插孔	10	以多角度播放	20
其他连接	11	同时播放 MP3 音乐和 JPEG 图像	20
USB 端口	11	特殊的 DivX 功能	20
遥控插孔	11	使用交互式菜单	20
		选择音频 / 字幕语言	20
开始	12	使用 USB 装置	21
步骤 1: 安装遥控器电池	12	所支持的 USB 装置	21
使用遥控器	12	播放数据文件	21
步骤 2: 打开电源	12		
步骤 3: 设置电视机类型 / 显示和语言	13		
设置电视机的色彩系统	13		
设置电视机的宽高比	13		
设置 OSD 语言	14		
设置音频, 字幕以及碟片菜单语言 (仅限于 DVD 视频)	14		

目录

设置菜单	22	语言编码	33
普通设置菜单	22	故障排除	34
锁定 / 解锁碟片以便观看	22	术语	37
前面板显示器的亮度调节	22	规格	39
编程碟片曲目 (MP3/WMA/JPEG/ DivX 除外)	22		
OSD 语言	23		
设置屏幕保护	23		
设置睡眠定时器	24		
设置自动待机功能	24		
显示 DivX® VOD 注册码	24		
音频设置菜单	24		
设置模拟输出	25		
设置数码输出	25		
开启或关闭 HDMI 音频	25		
开启或关闭深夜模式	26		
设置口形同步	26		
视频设置菜单	26		
电视类型	26		
设置电视机显示	27		
开启或关闭逐行扫描功能	27		
调节图像设置	28		
设置 HDMI 视频	29		
喜好设置菜单	30		
音频, 字幕以及碟片菜单	30		
父母控制的限制播放	30		
选择 VR 格式的播放	30		
选择 MP3/JPEG 菜单	31		
显示 DivX 外部字幕文件	31		
选择 PBC (播放控制) 功能	32		
改变密码	32		
系统复位	32		

多谢您购买本产品。本使用说明书说明使用本机的基本操作。

本说明书是在产品生产之前印刷的。由于改进等原因，设计和规格可能会有部分变更。如果说明书和产品存在不同，以产品为准。

提供的配件

- 遥控器
- 遥控器用的两节电池（AAA，R03，UM-4）
- 音频 / 视频针形缆线
- 使用说明书

区域码

本机支持区域码管理系统。请检查 DVD 碟片的封套确认其区域码。如果其区域码不匹配本机的区域码（参见下表或本机的背面），则本机不能播放该碟片。

目的地	本机的区域码	可播放碟片
美国， 加拿大		 
英国， 欧洲		 
亚洲， 韩国		 
澳大利亚， 中美洲和 南美洲		 

可播放碟片格式

本机可以使用以下具有以下标示的碟片。请不要尝试在本机装入其他类型的碟片。



本机可以播放：

- 以 DVD 视频兼容格式录制的 DVD-R/RW/R DL 和 DVD+R/RW/R DL 碟片。
- 以 VR 格式（CPRM 兼容）录制的 DVD-RW 碟片。
- 录制在 CD-R/RW，DVD-R/RW，DVD+R/RW 和 USB 的 MP3，WMA 和 JPEG 文件
- Kodak 图形 CD，FUJICOLOR CD
- ISO 9660 Level1/Level2 标准的 CD-R/W
- 每张碟片 / USB 装置可包含多达 298 个文件夹；每个文件夹最多可有 8 个级别，可包含多达 648 个文件
- 录制在 CD-R/RW，DVD-R/RW，DVD+R/RW 和 USB 的 DivX® 文件
 - 正式的 DivX® Ultra 认证的产品
 - 播放所有版本的 DivX® 视频（包括 DivX® 6），可增强播放 DivX® 媒体文件和 DivX® 媒体格式

注

- 不经过封尾处理的 CD-R/W，DVD-R/RW/R DL 和 DVD+R/RW/R DL 不能播放。
- 渐进 JPEG 和版权保护的 WMA 文件不能在本机播放。
- 只能播放 DVD-R/RW/R DL 和 DVD+R/R DL 的第一段。
- 根据碟片特性或录制条件，有些碟片可能无法播放。
- 不可使用任何非标准形状的碟片（比如心形等）。
- 不要使用粘贴有胶带，封条或表面上有很多划痕的碟片。
- 有关可播放格式的详情，请参阅第 39 页上的“规格”。

前言

清洁碟片

- 当碟片脏污，请使用干净的软布清洁。从中央向四周擦拭。不要沿圆周方向擦拭。
- 不要使用溶剂，比如苯，稀释剂，市售的清洁剂或用于模拟录音机的防静电喷雾剂等。

专利信息



经 Dolby Laboratories 许可生产。“Dolby”，“Pro Logic”及双 D 标章是 Dolby Laboratories 的注册商标。



“DTS”和“DTS Digital Out”是 DTS, Inc. 的注册商标。



DivX, DivX Ultra Certified, 以及相关标章是 DivX, Inc. 的注册商标。



HDMI, HDMI 标记和 High Definition Multimedia Interface 是 HDMI Licensing LLC. 的注册商标。

本产品装备有版权保护技术，该技术受若干美国专利和其他知识产权保护，这些权利为 Macrovision Corporation 和其他权利所有者拥有。使用该拷贝保护技术必须得到 Macrovision Corporation 许可，如果未经该公司许可，则只能用于家庭或其他有限范围。禁止反向工程或分解。

前部面板

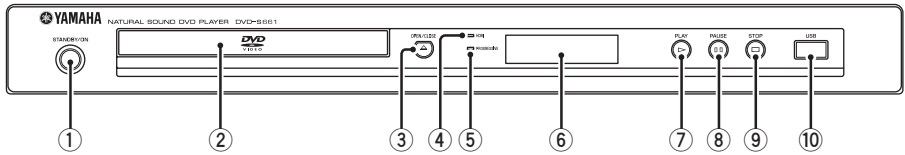

- ① **STANDBY/ON**
打开本机或将其设置为待机模式。
- ② **碟片托盘**
加载碟片到碟片托盘。
- ③ **OPEN/CLOSE (△)**
打开或关闭碟片托盘。
- ④ **HDMI 指示器**
当 HDMI 装置被连接并且通过本机的 HDMI 插孔输出信号时点亮。
- ⑤ **PROGRESSIVE 指示器**
当本机进入逐行模式时点亮。
- ⑥ **前部面板显示器**
显示本机的当前状态。
- ⑦ **PLAY (▷)**
开始播放。
- ⑧ **PAUSE (⏸)**
暂停播放。
- ⑨ **STOP (□)**
停止播放。
- ⑩ **USB 端口**
连接到您的 USB 装置的 USB 端口（请参阅第 11 页）。

后部面板

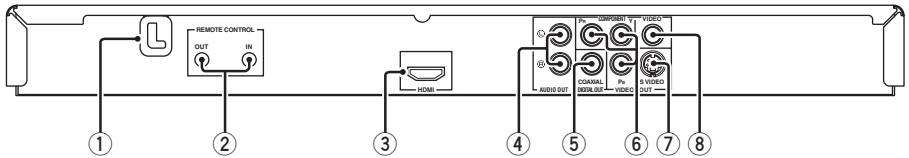

- ① **交流电源线**
将交流电源线插入墙壁上的交流插座。
- ② **REMOTE CONTROL (IN, OUT) 插孔**
将本机的 REMOTE CONTROL (IN) 插孔连接到您的 Yamaha AV 接收机的遥控输出插孔。
将本机的 REMOTE CONTROL (OUT) 插孔连接到您的 Yamaha 装置的遥控输入插孔（请参阅第 11 页）。
- ③ **HDMI 插孔**
连接到您的 HDMI 装置的 HDMI 输入插孔（请参阅第 10 页）。
- ④ **AUDIO OUT (L, R) 插孔**
连接到您的 AV 接收机或立体声系统的音频输入插孔（请参阅第 8 页）。
- ⑤ **DIGITAL OUT - COAXIAL 插孔**
连接到您的 AV 接收机的同轴输入插孔（请参阅第 8 页）。
- ⑥ **VIDEO OUT - COMPONENT (Y, Pb, Pr) 插孔**
连接到您的 AV 接收机的分量输入插孔（请参阅第 9 页）。
- ⑦ **VIDEO OUT - S VIDEO 插孔**
连接到您的 AV 接收机的 S- 视频输入插孔（请参阅第 9 页）。
- ⑧ **VIDEO OUT - VIDEO 插孔**
连接到您的 AV 接收机的复合视频输入插孔（请参阅第 9 页）。

注意：不要触及本机后面板上插孔中的针头。静电放电可能对本机造成永久损害。

遥控器

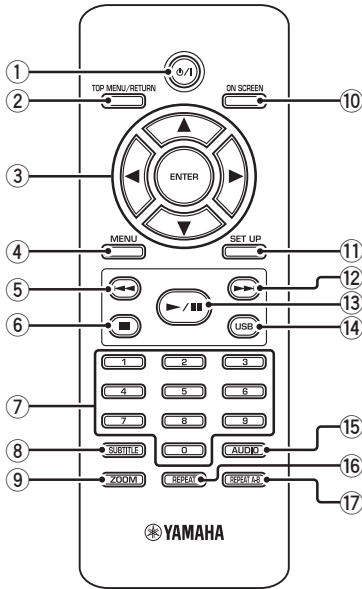

- ① **⏻/⏷**
打开本机或将其设置为待机模式。
- ② **TOP MENU/RETURN**
显示碟片的顶级菜单 (DVD)。
移回到前一菜单 (DVD*/VCD) (请参阅第 18 页)。
- ③ **⏪/⏩/⏴/⏵**
选择当前显示的菜单中的项目。
搜索或慢速播放。
ENTER
确认菜单选择。
- ④ **MENU**
显示碟片菜单 (DVD/JPEG) (请参阅第 16, 18, 19 和 20 页)。
切换 PBC 开或关 (VCD) (请参阅第 18 页)。

- ⑤ **⏪**
移动到前一章节或曲目。
向后搜索。*
- ⑥ **■**
停止播放。
打开碟片托盘。*
- ⑦ **数字按钮 (0-9)**
选择当前显示的菜单中标有号码的项目。
- ⑧ **SUBTITLE**
选择字幕语言 (请参阅第 18 和 20 页)。
- ⑨ **ZOOM**
放大视频图像 (请参阅第 16 和 19 页)。
- ⑩ **ON SCREEN**
进入或退出本机的在屏显示 (OSD) 菜单 (请参阅第 17 页)。
- ⑪ **SET UP**
进入或退出本机的设置菜单 (请参阅第 13 和 22 页)。
- ⑫ **⏩**
移动到后一章节或曲目。
向前搜索。*
- ⑬ **▶/⏸**
开始或暂停播放。
- ⑭ **USB**
进入连接的 USB 装置的目录或退出 USB 模式 (请参阅第 21 页)。
- ⑮ **AUDIO**
选择音频语言或格式 (请参阅第 18 和 20 页)。
- ⑯ **REPEAT**
进入或退出反复/随机模式 (请参阅第 15 页)。
- ⑰ **REPEAT A-B**
反复一个指定的区间 (请参阅第 16 页)。

* 按住该按钮大约 2 秒钟。

连接时的注意事项

在进行连接或改变连接之前，一定要关闭本机并拔下电源线。

- 根据您想要连接的装置的不同，连接的方法会多种多样。以下描述的是几种可能的连接方法。
- 为了更好地连接，请同时参考其他装置附带的说明书。
- 不要通过您的VCR连接本机。拷贝保护系统会导致视频图像变形。
- 不要将本机的音频输出插孔连接到您的音频系统的唱机输入插孔。

音频连接

数码连接

本机具有一个数码同轴输出插孔。使用市售的同轴缆线，将本机的 DIGITAL OUT - COAXIAL 插孔连接到您的装备有 Dolby Digital, DTS, 或 MPEG 解码器的 AV 接收机插孔。

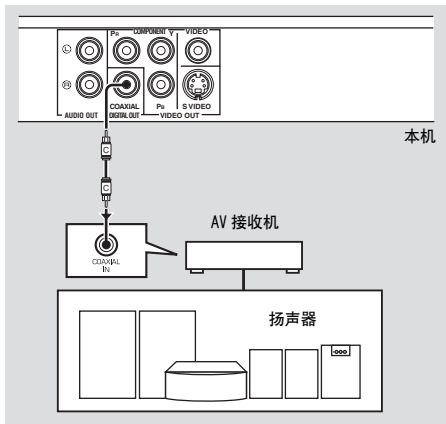

注

- 您需要设置 [数字输出] 到 [全部] (请参阅第 25 页上的“数字输出”)。
- 如果数码输出的音频格式与您的接收机的能力不匹配，接收机播放的音响会失真或者不发出声响。请务必在碟片的菜单屏幕上选择妥当的音频格式。
- 按下遥控器的 AUDIO 一次或多次，不但可以改变音频语言也可改变音频格式。选择的格式出现在前部面板显示器上几秒钟。
- 如果您期望欣赏 Dolby Digital, DTS 和 MPEG 格式，您必须连接本机到支持这些格式的接收机。

模拟连接

本机具有 2 声道模拟输出插孔。使用附带的音频针形缆线，连接本机的 AUDIO OUT (L, R) 插孔到您的音频装置 (比如立体声放大器) 的对应的输入插孔。

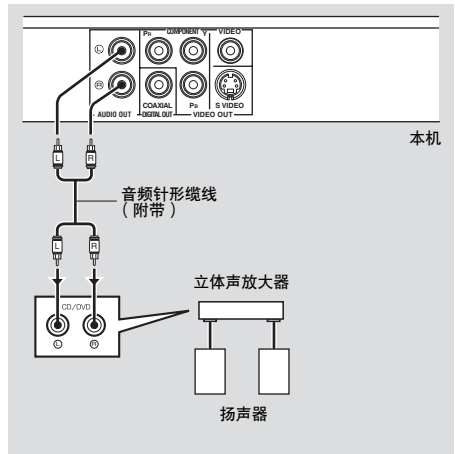

视频连接

如果您的 AV 接收机具有视频输出插孔，连接您的接收机，然后连接电视机，您的电视机就可以用于几个不同的视频源（LD，VCR 等），这只要在接收机上简单切换输入源即可。

本机具有几种类型的视频输出插孔。使用一个与即将连接的接收机上输入插孔对应的插孔。

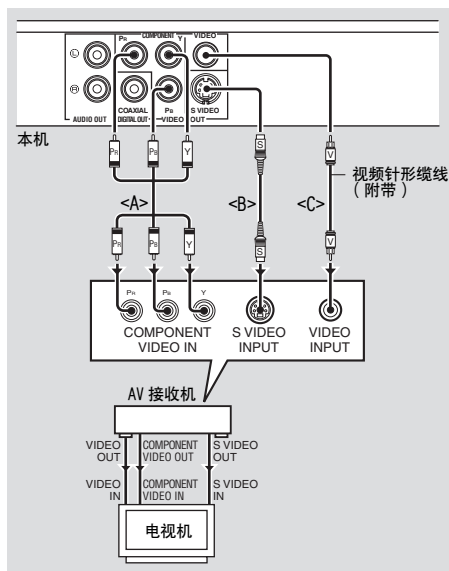

分量视频插孔 <A>

分量视频连接可以得到的图像色彩比 S- 视频更加逼真，这是因为传输视频信号时使用了分离的线路来传输亮度（Y：绿色）和色度（Pb：蓝色，Pr：红色）。

使用市售的分量视频缆线，连接本机的 VIDEO OUT - COMPONENT (Y, Pb, Pr) 插孔到您的 AV 接收机的分量输入插孔，然后连接电视机的对应端子。连接时请注意各个插孔的颜色。

如果您的接收机没有分量输出插孔，通过直接连接本机的分量输出插孔到电视机的分量输入插孔，您可以得到更好的视频图像。

S- 视频插孔

S- 视频连接可以得到比复合视频更加清晰的图像，这是因为传输视频信号时使用了分离的线路来传输亮度（Y）和色度（C）。

连接本机的 VIDEO OUT - S VIDEO 插孔到您的 AV 接收机的 S- 视频输入端插孔，然后使用市售的 S- 视频缆线，连接接收机和电视机。

复合视频插孔 <C>

连接本机的 VIDEO OUT - VIDEO 插孔到您的 AV 接收机的视频输入插孔，然后使用附带的视频针形缆线，连接接收机和电视机。

HDMI 连接

注

HDMI 插孔

HDMI 使用单一连接，提供高质量数码音频和视频。

连接本机的 HDMI 插孔到您的 AV 接收机的 HDMI 输入端插孔，然后使用市售的 HDMI 缆线，连接接收机和电视机。

如果您的接收机没有 HDMI 输出插孔，通过直接连接本机的 HDMI 插孔到电视机的 HDMI 输入插孔，您可以得到更好的视频图像。

当您连接本机到 HDTV 的 HDMI 插孔时，本机可以播放高分辨率的 JPEG 图像（720p 或 1080i）。有关详情，请参阅第 29 页上的“高清 JPEG”。

- 您需要设置 [HDMI 音频]（请参阅第 25 页）和 [HDMI 视频]（请参阅第 29 页）。
- 如果所连接的组件机不能输出音频，您必须进行适当的音频连接（请参阅第 8 页上的“音频连接”）。
- 本机不兼容 HDCP- 兼容的 HDMI 或 DVI 组件机。
- 当您将本机连接到 DVI 组件机时，请使用市售的 HDMI/DVI 转换缆线。在此情形下，本机的 HDMI 插孔不输出任何音频信号。
- 对于某些 DVI 组件机，图像的黑白成分可能不分明。在此情形下，可调节所连接 DVI 组件机的图形设置。
- 当有数据在传送时，不要关闭连接在本机 HDMI 插孔上的 HDMI/DVI 组件机的电源。否则会中断播放或造成噪音。
- 当连接 HDMI 组件机时，请参考该组件机的使用说明书。

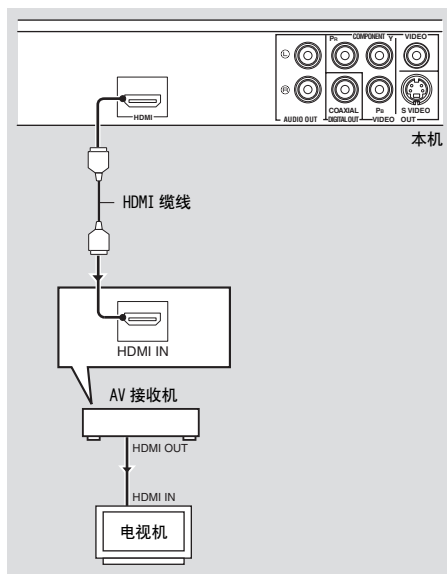

其他连接

USB 端口

本机具有 USB 端口，您可以访问储存在 USB 装置上的 MP3, WMA, DivX 和 JPEG 文件。

将您的 USB 装置连接到本机前面板上的 USB 端口。

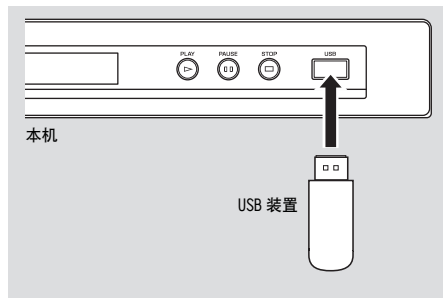

注

- 本机也许不能识别某些 USB 装置。
- 有关 USB 的详情，请参阅第 21 页上的“使用 USB 装置”。

遥控插孔

本机具有遥控输入 / 输出插孔。如果您的 AV 接收机是 Yamaha 产品而且具有传输 SCENE 控制信号的能力，您可以使用 SCENE 功能。

使用市售的单声道微型插孔缆线，连接本机的 REMOTE CONTROL (IN) 插孔到接收机的遥控输出插孔，您只要在接收机上简单地按下一个按钮，本机就会自动开始播放。

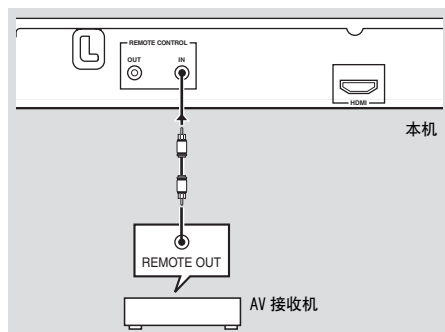

注

关于 SCENE 功能的详情，请参考您的 Yamaha AV 接收机附带的说明书。

开始

步骤 1：安装遥控器电池

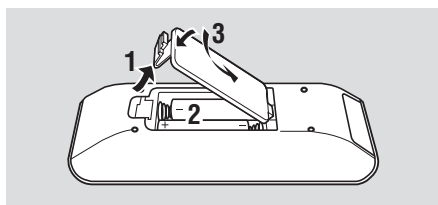

- 1 打开电池舱盖。
- 2 装入附带的两节（AAA，R03，UM-4）电池，确认与电池舱中的标示（+/-）一致。
- 3 关闭舱盖。

注

- 装入电池时要按照指示的极性标记（+/-）正确装入。极性装反的电池可能出现泄漏。
- 要及时用新电池更换耗尽的电池以免出现泄漏。
- 如果一个月以上不使用遥控器，请从电池舱中取出电池。
- 如果电池漏液，请立即将其处理掉。请勿触摸泄漏的物质或让其接触到衣服等。在安装新电池之前，请彻底清洁电池舱。
- 新旧电池请勿混用。
- 请勿将不同型号的电池一起使用（例如碱性电池和锰电池）。请仔细阅读包装，因为这些不同类型的电池可能具有相同的外形和颜色。
- 丢弃电池时请按照当地有关规定进行。

使用遥控器

在本机的 6 米之内使用遥控器，将其对准遥控传感器。

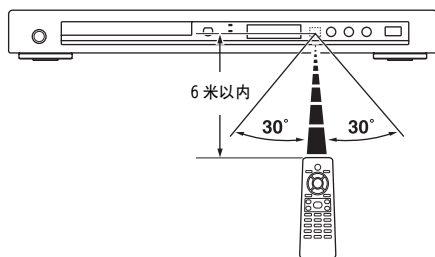

注

- 请勿将水或其它液体洒在遥控器上。
- 请勿跌落遥控器。
- 请勿将遥控器放于或储存于下列环境中：
 - 高湿度的地方，例如浴室附近
 - 高温地点，例如加热器或炉子附近
 - 温度极低的地点
 - 肮脏的地方
- 当遥控器工作不稳定时，缩小其与传感器的夹角。

步骤 2：打开电源

- 1 将交流电源线插入交流插座。
- 2 打开电视机和 AV 接收机。
- 3 为 AV 接收机选择妥当的输入源（请参考 AV 接收机附带的说明书）。
- 4 按下前面板的 STANDBY/ON 或遥控器的 \mathbb{O}/I ，打开本机。
→ 前面板显示器点亮。
- 5 设置电视机到妥当的视频输入（请参考电视机附带的说明书）。
→ 默认菜单屏幕出现在电视机上。

步骤 3：设置电视机类型 / 显示和语言

您可以使用显示在电视机屏幕上的设置菜单对本机进行定做。

注

- 如果没有特殊说明，这里描述的所有操作使用附带的遥控器。
- 要返回到上一菜单，按 ◀。
- 要退出菜单时，按 SET UP。

设置电视机的色彩系统

本机兼容 NTSC 和 PAL 两种视频格式。选择与您的电视机匹配的色彩系统。

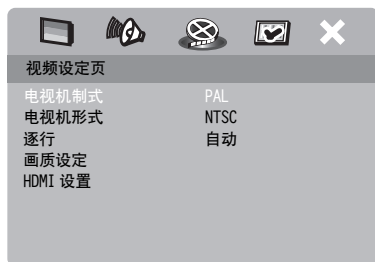

- 1 按下 SET UP。
- 2 反复按下 ▶，选择“视频设定页”。
- 3 按下 ▲/▼，以高亮度显示 [电视机制式]，然后按下 ▶。
- 4 按下 ▲/▼，以高亮度显示下列选项之一。

PAL

如果连接的电视机是 PAL 制式的电视机，选择这个。它将改变 NTSC 碟片的视频信号，将其按 PAL 格式输出。

NTSC

如果连接的电视机是 NTSC 制式的电视机，选择这个。它将改变 PAL 碟片的视频信号，将其按 NTSC 格式输出。

自动

如果连接的电视机兼容 NTSC 和 PAL 格式双方（比如多制式电视机），选择这个。输出格式依碟片的音频格式而定。

- 5 选择一个项目，然后按下 ENTER。

注

- 在改变当前电视机标准设置之前，请确认您的电视机支持所选择的电视机类型。
- 如果图像在电视机上不能妥当显示，请等待 15 秒钟，本机自动恢复。
- 当进行 HDMI 连接时，您不能改变或选择 [电视机制式]。

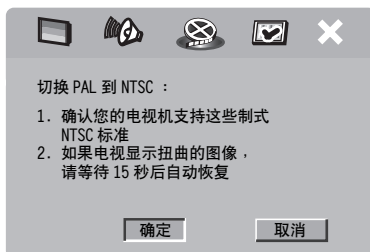

设置电视机的宽高比

您可以设置本机的宽高比以匹配您的电视机。当您的电视机的宽高比为 4:3 则没有必要改变此设置。如果您使用宽屏幕电视机，根据以下步骤改变该设置。

有关详情，请参阅第 27 页上的“设置电视机显示”。

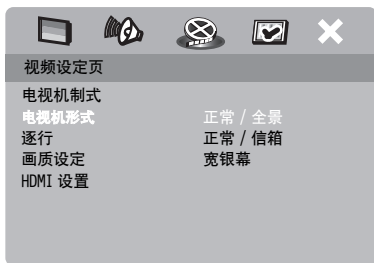

- 1 按下 SET UP。
- 2 反复按下 ►，选择“视频设定页”。
- 3 按下 ▲/▼，以高亮度显示 [电视机形式]，然后按下 ►。
- 4 按下 ▲/▼，以高亮度显示 [宽银幕]，然后按下 ENTER。

设置 OSD 语言

您可以为设置菜单选择自己喜欢的语言。一旦选择，该设置保持不便。



- 1 按下 SET UP。
- 2 按下 ◀/▶，选择“通用设定页”。
- 3 按下 ▲/▼，以高亮度显示 [画面显示语言]，然后按下 ►。
- 4 按下 ▲/▼，选择一种语言，然后按下 ENTER。

设置音频，字幕以及碟片菜单语言 (仅限于 DVD 视频)

您可以为音频，字幕和碟片菜单选择自己喜欢的语言。只要装入碟片，本机将自动切换到您选择的语言。如果您所选择的语言碟片中不存在，则会使用碟片的默认语言。

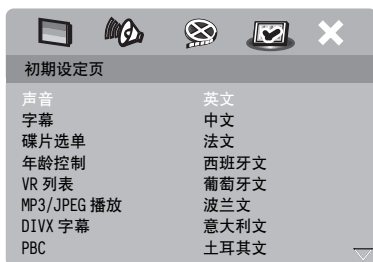

- 1 按下 ■ 两次，然后按下 SET UP。
- 2 反复按下 ►，选择“初期设定页”。
- 3 按下 ▲/▼，以高亮度显示以下选项之一，然后按下 ►。
 - 声音 (音频语言)
 - 字幕 (字幕语言)
 - 碟片选单 (碟片菜单语言)
- 4 按下 ▲/▼，选择一种语言，然后按下 ENTER。
- 5 对于其他语言设置，反复步骤 3-4。

■ 要选择不在列表中语言

- 1 选择 [声音] 的 [其它] 或 [字幕] 或 [碟片选单]。
- 2 使用数字按钮 (0-9) 键入 4 位数语言编码 (请参阅第 33 页上的“语言编码”)，然后按下 ENTER。

注

- 当按下某个按钮，如果禁止图标 (⊗) 出现在电视机屏幕上，则说明对于当前的碟片或目前状况下，该按钮对应的功能不能使用。
- 如果没有特殊说明，这里描述的所有操作使用附带的遥控器。
- 根据碟片的不同，某些操作也许不同或有所限制。请参考碟片附带的说明书。
- 不能给碟片托盘中推入或放入碟片以外的任何物品。这样会损坏本机。

基本操作

- 1 确保本机打开。
- 2 按下前面板的 OPEN/CLOSE (△)，打开碟片托盘。
- 3 在碟片托盘中放置碟片，印刷面向上。
- 4 再次按下 OPEN/CLOSE (△)，关闭碟片托盘。
 - 碟片认知后，本机自动开始播放。
 - 当碟片托盘打开后，如果您按下 ►/||，碟片托盘关闭，播放自动开始。
- 5 在播放中，要暂停播放，按下 ►/||。
 - 播放暂停，声音停止。
 - 反复按下前面板上的 PAUSE (⏏)，可以进行逐帧播放。
- 6 要恢复正常播放，再次按下 ►/||。
- 7 要停止播放，按下 ■。

选择曲目 / 章节

- 1 按下 ◀◀/▶▶ 或使用数字按钮 (0-9) 选择曲目 / 章节号码。
- 2 在反复播放曲目 / 章节时，按下 ◀◀/▶▶，重新播放该曲目 / 章节。

向后 / 向前搜索

- 1 按住 ◀◀/▶▶，或按下 ◀/▶。
- 2 在搜索时，反复按下 ◀◀/▶▶ 或 ◀/▶，选择期望的速度。
- 3 要恢复正常播放，按下 ►/||。

注

- 对有些碟片 ◀/▶ 按钮可能无效。
- 对于 MP3 和 WMA，搜索功能允许您搜索当前正在播放的曲目。

反复 / 随机功能

反复 / 随机播放

播放中，每按下 REPEAT 一次，前面板显示器的显示按以下次序变化：

DVD

- RPT ONE (反复播放章节)
- RPT TT (反复播放标题)
- RPT ALL (反复播放全部)
- SHUFFLE (随机播放)
- RPT SHF (随机反复播放)
- RPT OFF (不反复播放)

VCD/SVCD/CD

- RPT ONE (反复播放曲目)
- RPT ALL (反复播放全部)
- SHUFFLE (随机播放)
- RPT SHF (随机反复播放)
- RPT OFF (不反复播放)

播放操作

MP3/WMA/DivX

- RPT ONE (反复播放曲目)
- RPT FLD (反复播放文件夹)
- SHUFFLE (随机播放)
- RPT OFF (不反复播放)

注

对于 VCD，当 PBC 模式被打开时，反复播放不能进行。

反复播放章节 / 曲目内的一段

- 1 在播放一张碟片时，在期望的开始点按下 REPEAT A-B。
 - “SET A” 出现在前部面板显示器中。
- 2 在您期望的结束点，再次按下 REPEAT A-B。
 - A 和 B 的设置只能在相同章节 / 曲目内。
 - “RPT AB” 出现在前部面板显示器中，选择的段落被连续反复播放。
- 3 退出序列时，请按下 REPEAT A-B。

视频播放操作 (DVD/VCD/SVCD)

使用碟片菜单

对于某些碟片，只要装入碟片，菜单可能会显示在电视机屏幕上。

■ 要选择播放功能或项目

使用 ◀/▶/▲/▼ 或数字按钮 (0-9)，然后按下 ENTER，开始播放。

■ 要进入或退出菜单

按下 MENU。

以慢动作播放

您可以以慢动作播放视频。

- 1 按下 ▲ 从后到前播放慢动作；或按下 ▼ 从前到后播放慢动作。
- 2 在播放慢动作时，反复按下 ▲/▼ 选择期望的速度。
- 3 要恢复正常播放，按下 ▶/|| 或 ENTER。

注

对于 VCD 和 SVCD，从后到前的慢动作播放无效。

放大 / 缩小图像

您可以将图像在电视机屏幕上放大或缩小，且可以移动放大的图像。

- 1 在播放时，反复按下 ZOOM，以不同的比率显示图像。
 - 使用 ◀/▶/▲/▼ 移动放大的图像。
 - 播放继续。
- 2 反复按下 ZOOM，返回到原来的大小。

从最后停止点重新开始播放

即使碟片被取出或本机的电源被关闭，您仍然可以重新开始最后十张碟片的播放。

- 1 装入最后十张碟片之一。
 - “读碟” 出现在电视机屏幕中。
- 2 当 “读碟” 出现在电视机屏幕中时，按下 ▶/||。
 - “记忆播放” 出现在电视机屏幕中，碟片从最后停止点开始播放。

■ 要解除重新播放模式

当播放停止时，再次按下 ■。

使用在屏显示 (OSD)

OSD 菜单显示碟片播放信息 (比如, 标题或章节号码, 经过时间或音频 / 字幕语言)。在不干扰碟片播放的同时, 可以进行一些操作。

- 1 在播放中, 按下 ON SCREEN。
→ 电视机屏幕上出现碟片的信息清单。

DVD

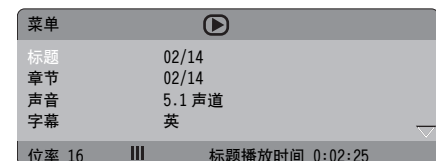

VCD/SVCD



- 2 按下 ▲/▼ 滚动显示信息, 然后按下 ENTER 进入选择的项目。
- 3 使用数字按钮 (0-9) 输入号码/时间或按下 ▲/▼ 进行选择, 然后按下 ENTER。
→ 播放跳转到选择的时间或选择的标题 / 章节 / 曲目。

■ 标题 / 章节 / 曲目选择 (DVD/VCD)

- 1 按下 ▲/▼ 选择 [标题] 或 [章节] (DVD) 或 [曲目] (VCD)。
- 2 按下 ENTER。
- 3 使用数字按钮 (0-9) 选择标题, 章节或曲目号码。

■ 时间搜索 (DVD/VCD)

- 1 按下 ▲/▼ 选择 [标题时间] / [章节时间] (DVD) 或 [曲目时间] / [全碟时间] (VCD)。
 - [标题时间] 指的是当前标题的总时间, [章节时间] 指的是当前章节的总时间。
- 2 按下 ENTER。
- 3 使用数字按钮 (0-9) 从左到右键入小时, 分钟和秒 (例如 0:34:27)。

■ 音频 / 字幕 / 角度选择 (DVD)

如果正在播放的碟片具有这些功能, 您可以改变 [声音], [字幕] 或 [角度]。

- 1 按下 ▲/▼ 选择 [声音], [字幕] 或 [角度]。
- 2 按下 ENTER。
- 3 对于音频和字幕:
按下 ▲/▼ 高亮显示您的选择, 然后按下 ENTER。

或

对于角度:

使用数字按钮 (0-9) 选择一个角度。

播放操作

■ 反复 / 时间显示 (DVD/VCD)

- 1 按下 ▲/▼ 选择 [重复播放] 或 [时间显示]。
- 2 按下 ENTER。
- 3 按下 ▲/▼ 高亮显示您的选择, 然后按下 ENTER。

■ 时间显示 (CD)

每按下 ON SCREEN 一次, 时间显示变化如下:

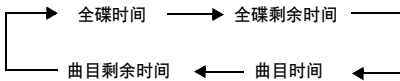

特殊的 DVD 功能

标题的播放

- 1 按下 MENU。
→ 碟片标题菜单出现在电视机屏幕上。
- 2 使用 ◀/▶/▲/▼ 或数字按钮 (0-9) 选择播放选项。
- 3 按下 ENTER。

选择音频语言 / 格式和字幕语言

■ 要选择音频语言 / 格式

反复按下 AUDIO 选择音频语言和 / 或格式。

■ 要选择字幕语言

反复按下 SUBTITLE, 以选择字幕语言。

特殊的 VCD/SVCD 功能

使用播放控制 (PBC) 菜单

具有播放控制 (PBC) 功能的 VCD (仅限于 2.0 版本)

- 1 按下 MENU, 在 “PBC 开” 和 “PBC 关” 之间切换。
→ 如果您选择 “PBC 开”, 碟片菜单出现 (如果有效) 在电视机屏幕上。
 - 2 使用数字按钮 (0-9) 选择播放选项。
 - 按下 ◀◀/▶▶ 移动到上 / 下一页码 (如果有效)。
 - 3 在播放中, 按下 TOP MENU/RETURN 可返回菜单屏幕。
- 要跳越索引菜单从碟片的开头播放
按下 MENU, 关闭 PBC 功能。

播放数据碟片 (MP3/WMA/JPEG/DivX)

- 1 装入数据碟片。
 - 根据目录 / 文件结构的复杂程度, 碟片的读取时间有可能超过 30 秒钟。
 - 数据碟片菜单出现在电视机屏幕上。

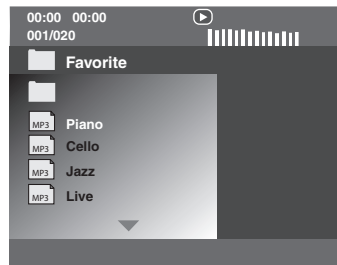

- 2 播放自动开始。否则，按下 ▶/||。
- 3 按下 ◀◀/▶▶，选择当前文件夹中的另一个曲目 / 文件。

注

- 因为碟片的配置和特性以及碟片的录制条件等，某些 MP3/WMA/JPEG/DivX 碟片也许不能播放。
- 当第一个图像被显示或碟片被退出时，HD JPEG 图像也许不能正确显示。有关 HD JPEG 的详情，请参阅第 29 页上的“高清 JPEG”。
- 根据图像大小不同，HD JPEG 图像也许以更小的尺寸显示。

选择一个文件夹和曲目 / 文件

- 1 按下 ▲/▼ 选择一个文件夹，然后按下 ENTER 打开文件夹。
- 2 按下 ▲/▼ 选择一个曲目 / 文件。
- 3 按下 ENTER。
 - 播放从选择的文件开始到文件夹的最后。

特殊的图像碟片功能

- 1 装入一张图像碟片（JPEG，Kodak Picture CD 或 Fujicolor CD）。
 - 对于 JPEG，图像菜单出现在电视机屏幕上。
 - 对于 Kodak Picture CD 和 Fujicolor CD，幻灯显示开始。

■ 对于 JPEG

- 2 按下 ▶/|| 开始幻灯显示。

使用预览功能

该功能显示当前文件夹或整个碟片的内容。

- 1 在播放时按下 ■。
 - 12 个小图标出现在电视机屏幕上。

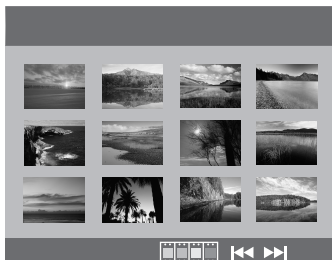

- 2 按下 ◀◀/▶▶ 显示前 / 后一页上的其他小图标。
- 3 使用 ◀/▶/▲/▼ 以高亮度显示小图标之一，然后按下 ENTER 开始播放。

或

把光标移动到该页底部以高亮度显示 ，从当前页的第一个小图标开始播放。

■ 对于 JPEG

- 4 按下 MENU 返回 JPEG 碟片菜单。

放大 / 缩小图像

- 1 在播放时，反复按下 ZOOM，以不同的比率显示图像。
- 2 使用 ◀/▶/▲/▼ 移动放大的图像。

播放操作

以多角度播放

在播放中，按下 ◀/▶/▲/▼ 在电视机屏幕上旋转图像。

- ◀：反时针方向旋转图片
- ▶：顺时针方向旋转图片
- ▲：垂直地翻转图片
- ▼：平行地翻转图片

注

对于 HD JPEG，▲/▼ 按钮无效。

同时播放 MP3 音乐和 JPEG 图像

- 1 装入一张既包含有 MP3 音乐又包含有 JPEG 图像数据的碟片。
→ 碟片菜单出现在电视机屏幕上。
- 2 选择一个 MP3 音乐曲目。
- 3 在 MP3 音乐播放中，从电视机屏幕上选择 JPEG 图像文件，按下 ▶/||。
→ 图像文件被接连播放直到文件夹的最后。
- 4 要停止同时播放，按下 MENU，然后按下 ■。

注

- 根据碟片特性或录制条件，有些文件可能无法播放。
- 当 [高清 JPEG] 被设置为 [开]，该功能无效（请参阅第 29 页）。

特殊的 DivX 功能

DivX 文件只包含 DMF（DivX 媒体格式）功能

使用交互式菜单

- 1 装入一张碟片。
→ 交互式菜单出现在电视机屏幕上。
- 2 使用 ◀/▶/▲/▼ 选择章节。
- 3 按下 ENTER 或 ▶/|| 选择的章节开始播放。

■ 要进入交互式菜单

在播放中，按下 MENU。

■ 要返回到数据碟片菜单屏幕

当交互式菜单显示时，按下 ■。

选择音频 / 字幕语言

■ 要选择音频语言

在播放中，按下 AUDIO 可切换碟片上录制的音频语言。

■ 要选择字幕语言

在播放中，按下 SUBTITLE 可切换或开 / 关碟片上录制的字幕语言。

注

关于外部字幕文件的信息，请参阅第 31 页上的“显示 DivX 外部字幕文件”。

使用 USB 装置

您可以播放储存在所支持的 USB 装置中的 MP3, WMA, JPEG 和 DivX 文件。

所支持的 USB 装置

本机支持使用 FAT16 或 FAT32 格式的 USB 大容量存储器（例如，闪存存储器，读卡器，便携式音频播放器）。

注

- 即使符合要求，有些 USB 装置也许仍然不能正常工作。
- 当您连接 USB 装置时，如果“该设备不受支持。”出现在电视机屏幕上，请遵从以下步骤。
 - 将本机设置为待机模式，然后再次打开本机。
 - 当本机为待机模式时拔掉 USB 装置，然后再次连接并打开本机。
 - 如果装置附带有 AC 适配器连接该适配器。即使您完成了该步骤，如果“该设备不受支持。”出现，本机的 USB 装置仍然不能播放。
- 如果“USB 当前已被写保护。该设备不受支持。”出现在电视机屏幕上，则本机不能播放该 USB 装置，因为该装置的能耗太高。
- 本机不能同时读取两个以上的读卡器槽，虽然它最多可以认可六个槽。第一个槽具有优先权。
- 对于外部硬盘驱动器，本机兼容 80 GB 以下的大小。
- 请不要连接 USB 大容量存储器以外的装置：USB 充电器，USB 集线器，个人计算机等等

播放数据文件

连接到本机的 USB 装置中保存的数据如果丢失，Yamaha 和经销商将不承担任何责任。作为警告，建议在文件保存后对其进行检查。

- 1 连接您的 USB 装置到本机的 USB 端口（请参阅第 11 页上的“USB 端口”）。

→ “按 USB 模式键切换设备”出现在电视机屏幕中。

- 2 按下 USB。

- 根据文件 / 文件夹的数目，碟片的读取时间有可能超过 30 秒钟。

→ 文件菜单出现在电视机屏幕上。

- 3 遵从第 18 页上的“播放数据碟片（MP3/WMA/JPEG/DivX）”的步骤。

■ 要退出 USB 模式

按下 ■ 停止播放，然后按下 USB。

注

- 当“读碟”出现在电视机屏幕中时，您不能进入 USB 模式。
- 如果您拔除 USB 装置或打开本级的碟片托盘，播放模式自动切换到碟片模式。
- 对于 DivX，本机兼容的比特率范围是 3 Mbps 以下。
- 根据 USB 装置的规格，有些文件也许不能正常工作。
 - 对于 DivX，视频有可能停止片刻，声音也可能出现断续。
 - 对于 MP3，当 MP3/JPEG 同时播放时，声音可能出现断续。
 - 在此情形下，可以更低的比特率或尺寸记录文件，这样就可以使得文件工作正常。
- 版权保护的文件不能播放。
- 本机可以显示最多 648 个文件。但是，如果有些文件不能在本机播放，所显示的文件可能少于 648 个。
- 如果 USB 装置被分区，则只能显示第一个分区。
- 本级可以播放的文件大小为 4 GB 以下。

设置菜单

设置在电视屏幕上进行，您可对本机进行用户定做，使其满足您的特别需要。

注

- 如果没有特殊说明，这里描述的所有操作使用附带的遥控器。
- 要返回到上一菜单，按 ◀。
- 要退出菜单时，按 SET UP。

普通设置菜单

- 1 按下 SET UP。
- 2 按下 ◀/▶，选择“通用设定页”。
- 3 按下 ENTER。

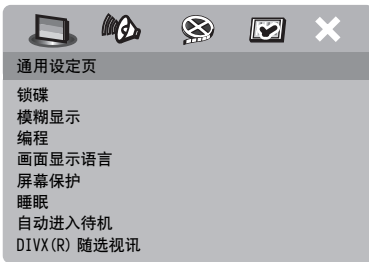

锁定 / 解锁碟片以便观看

不是所有碟片都被制造厂家进行分级或编码。您可以锁定某个碟片以禁止其播放。本机最多可以锁定 40 个碟片。

- 1 在“通用设定页”，按下 ▲/▼，以高亮度显示 [锁碟]，然后按下 ▶。

锁

选择该项以锁定当前碟片禁止其播放。以后使用锁定的碟片时需要输入 6 位密码。默认密码是“000 000”（请参阅第 32 页上的“改变密码”）。

解锁

选择该项以解锁当前碟片允许其播放。

- 2 按下 ▲/▼ 选择一种设置，然后按下 ENTER。

前面板显示器的亮度调节

您可以为前面板显示器选择不同的亮度水平。

- 1 在“通用设定页”，按下 ▲/▼ 以高亮度显示 [模糊显示]，然后按下 ▶。

100%

需要最高亮度时选择该项。

70%

需要中等亮度时选择该项。

40%

需要低亮度时选择该项。

- 2 按下 ▲/▼ 选择一种设置，然后按下 ENTER。

编程碟片曲目（MP3/WMA/JPEG/DivX 除外）

您可以对碟片中将要播放的曲目，使其内容按照期望的次序播放。您可以存储 20 个曲目 / 碟片，最多 10 张碟片。

- 1 在“通用设定页”，按下 ▲/▼ 以高亮度显示 [编程]，然后按下 ▶ 选择 [进入菜单]。

- 按下 ENTER。
→ 输入菜单出现在电视机屏幕上。

编程：曲目 (01-17)

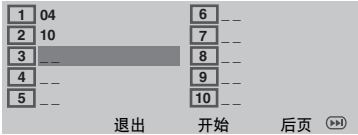

■ 要输入您喜欢的曲目 / 章节

- 使用数字按钮 (0-9) 键入妥当的曲目 / 章节号码。
- 按下 / / / 移动光标到下一个位置。
 - 如果曲目 / 章节的号码大于 10, 按下 移动到下一页, 然后继续编程。
 - 或
 - 使用 / / / , 以高亮度显示编程菜单的 [后页], 然后按下 ENTER。
- 反复步骤 3-4 输入其他曲目 / 章节号码。

■ 要删除一首曲目

- 使用 / / / 移动光标到要删除的曲目。
- 按下 ENTER 从编程菜单中删除该曲目。

■ 要开始编程播放

- 使用 / / / , 以高亮度显示编程菜单的 [开始], 然后按下 ENTER。
→ 按编程的次序从选择的曲目开始播放。

■ 要退出编程播放

- 使用 / / / , 以高亮度显示编程菜单的 [退出], 然后按下 ENTER。

OSD 语言

本菜单包含各种在屏幕显示 (OSD) 语言的选项。有关详情, 请参阅第 14 页上的“设置 OSD 语言”。

设置屏幕保护

该功能用来打开或关闭屏幕保护。

- 在“通用设定页”, 按下 / , 以高亮度显示 [屏幕保护], 然后按下 。

开

选择此项可以在碟片停止或暂停播放 15 分钟后关闭屏幕。

关

选择此项可取消屏幕保护功能。

- 按下 / , 选择一个设置, 然后按下 ENTER。

设置菜单

设置睡眠定时器

该功能自动设置本机在一定时间后进入待机模式。

- 1 在“通用设定页”，按下 ▲/▼ 以高亮度显示 [睡眠]，然后按下 ►。
- 2 按下 ▲/▼ 选择一个设置。
 - 您可以选择30, 60, 90, 120 和 150 分钟。选择 [关] 取消睡眠定时器功能。
- 3 按下 ENTER。

设置自动待机功能

该功能用来在碟片停止播放 30 分钟后使得本机的自动待机模式开启或关闭。

- 1 在“通用设定页”，按下 ▲/▼ 以高亮度显示 [自动进入待机]，然后按下 ►。

开

选择此项可以在碟片停止或暂停播放 30 分钟后使得本机自动进入待机模式。

关

选择此项可取消自动待机功能。

- 2 按下 ▲/▼ 选择一种设置，然后按下 ENTER。

显示 DivX® VOD 注册码

Yamaha 提供 DivX® VOD (Video On Demand) 注册码，它可以帮您通过 DivX® VOD 服务购买或租赁视频产品。有关详情，请访问 <https://vod.divx.com/>。

- 1 在“通用设定页”，按下 ▲/▼ 以高亮度显示 [DIVX(R) 随选视讯]，然后按下 ►。
→ 注册码出现。
- 2 按下 ENTER 退出。

注

- 要从 <https://vod.divx.com/> 的 DivX® VOD 服务购买或租赁视频商品时，使用注册密码然后下载视频内容到 CD-R 以便在本机播放。
- 所有从 DivX® VOD 下载的视频只能在本机播放。
- 对于 DivX，时间搜索功能无效。

音频设置菜单

- 1 按下 SET UP。
- 2 按下 ◀/▶，选择“音频设定页”。
- 3 按下 ENTER。

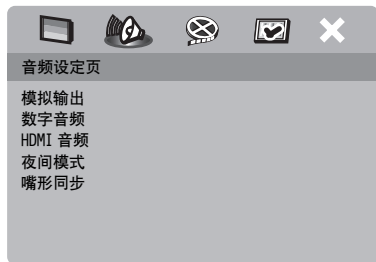

设置模拟输出

设置模拟输出使其与本机的能力匹配。

- 1 在“音频设定页”，按下 ▲/▼ 以高亮度显示 [模拟输出]，然后按下 ►。

立体声

选择此项来改变声道输出为立体声，即，仅从两前方扬声器输出音响。

LT/RT

如果本机连接到 Dolby Pro Logic 解码器选择此项。

- 2 按下 ▲/▼ 选择一种设置，然后按下 ENTER。

设置数码输出

[数字音频] 的选项有：[数字输出] 和 [LPCM 输出]。

- 1 在“音频设定页”，按下 ▲/▼，以高亮度显示 [数字音频]，然后按下 ►。
- 2 按下 ▲/▼ 以高亮度显示一个选项。
- 3 按下 ► 打开一个子菜单。

数字输出

根据您的选择的音频装置的连接，设置数码输出。

关

选择此项以关闭数码输出。

全部

选择此项当您连接了数码音频输出插孔到多声道解码器 / 接收机。

MPEG → PCM

当您的接收机不能解码 MPEG 音频信号时选择此项。

仅 PCM

仅当您的接收机不能解码多声道音频信号时选择此项。

LPCM 输出

如果您在数码端子，比如同轴端子上连接了 PCM 兼容的接收机，可选择此项。在此情形下，您可能需要调节 [LPCM 输出]。碟片按一定的取样率录制。取样率越高，音质越好。

48KHz

设置此项可播放取样率 48 kHz 录制的碟片。所有 96 kHz PCM 数据流（如果有）均被转换为 48 kHz 取样率。

96KHz

设置此项可播放取样率 96 kHz 录制的碟片。如果 96 kHz 碟片受到拷贝保护，数码输出被自动转换为 48 kHz 取样率。

- 4 按下 ▲/▼ 选择一种设置，然后按下 ENTER。

开启或关闭 HDMI 音频

当您通过 HDMI 插孔将本机连接到 HDMI 兼容的组件机时，选择开启或关闭 HDMI 音频输出。

- 1 在“音频设定页”，按下 ▲/▼ 以高亮度显示 [HDMI 音频]，然后按下 ►。

开

选择此项以开启 HDMI 音频输出。

关

选择此项以关闭 HDMI 音频输出。

设置菜单

注

- 如果您不是用 HDMI 音频输出，设置此项为 [关]。
- 如果使用 HDMI 连接到本机的监视器 / 接收机不支持 HDMI 音频信号输出，设置此项为 [关]。
- 本机可使用 HDMI 输出下列音频信号：32/44.1/48 kHz，2 声道线性 PCM 信号和比特流信号 (Dolby Digital, DTS 及 MPEG)。
- 当通过 HDMI 兼容的组件机输出音频信号时，数码输出信号被静音。
- 当在本机 [数字输出] 被设置为 [关]，即使 [HDMI 音频] 被设置为 [开] 并且监视器和接收机之间建立了 HDMI 连接，HDMI 音频仍然被静音。
- 当在本机 [数字输出] 被设置为 [全部]，如果监视器和接收机仅支持 PCM 格式，PCM 信号仍然输出。但是，当音频格式播放 DTS 音源时，音频输出静音。

开启或关闭深夜模式

在深夜模式，高音量输出被柔和处理，低音量输出被提高到可以听到的水平。如果您想在夜间观看您所喜欢的动作片，为了不干扰别人，该功能很有用。

- 1 在“音频设定页”，按下 ▲/▼ 以高亮度显示 [夜间模式]，然后按下 ►。

开

选择此项可拉平音量。此功能仅限于 Dolby Digital 模式的电影。

关

当您期望欣赏全范围的环绕声音响时，选择此项。

- 2 按下 ▲/▼，选择一个设置，然后按下 ENTER。

设置口形同步

该功能使得您可以延迟声音的输出以便声音和视频图像同步。当使用某些液晶显示器或投影仪时也许需要该功能。

- 1 在“音频设定页”，按下 ◀/▶ 以高亮度显示 [嘴形同步]，然后按下 ►。
- 2 按下 ◀/▶ 调节滞后时间 (00 ms-200 ms 之间)，然后按下 ENTER。

视频设置菜单

- 1 按下 SET UP。
- 2 按下 ◀/▶，选择“视频设定页”。
- 3 按下 ENTER。

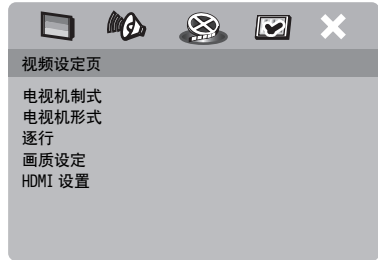

电视类型

此菜单包括选择为匹配您的电视机的色彩制式的选项。有关详情，请参阅第 13 页上的“设置电视机的色彩系统”。

设置电视机显示

设置本机的宽高比以匹配您的电视机。碟片上必须有您所选择的格式。否则，电视机设置将不会影响播放中的图像。

- 1 在“视频设定页”，按下 ▲/▼ 以高亮度显示 [电视机形式]，然后按下 ►。
- 2 按下 ▲/▼，以高亮度显示下列选项之一。

正常 / 全景

如果您的电视机的宽高比是 4:3，选择此项，此时，图像的两个方向都被截去或格式化以适合您的电视机屏幕。

正常 / 信箱

当您的电视机的宽高比为 4:3。在此情形下，宽银幕图像在电视机上显示时，上下各有一条黑带。



宽银幕

如果您有一个宽屏幕电视机，选择此项。

- 3 选择一个项目，然后按下 ENTER。

■ 本机的设置和电视机显示的关系

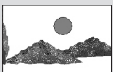
当您的电视机的宽高比为 4:3:

设置	播放碟片	电视机显示	
正常 / 全景	16:9		*1
	4:3		
正常 / 信箱	16:9		
	4:3		

当您的电视机的宽高比为 16:9（宽屏幕）:

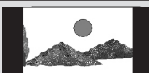
设置	播放碟片	电视机显示	
宽银幕	16:9		
	4:3		*2

*1: 如果碟片不能以全景播放，就使用信箱播放。

*2: 有些电视机上，图像的一个方向可能被拉长。在此情形下，请检查您的电视机的屏幕尺寸和宽高比。

开启或关闭逐行扫描功能

该功能仅当您通过分量视频插孔（请参阅第 9 页上的“分量视频插孔 <A>”）连接具有逐行扫描功能的电视机时有效。

- 1 在“视频设定页”，按下 ▲/▼ 以高亮度显示 [逐行]，然后按下 ►。

关

选择此项以解除逐行扫描功能。

开

选择此项以启用逐行扫描功能。

- 2 按下 ▲/▼，选择一个设置，然后按下 ENTER。

设置菜单

启用逐行扫描的注意事项：

- 请确认您的电视机具有逐行扫描功能。
- 使用分量视频缆线连接。
- 当进行 HDMI 连接时，您不能选择 [逐行]。

用户必须注意，不是所有高清晰度电视机都与本机完全兼容，它们会在显示图像时出现非自然信号。在 525 或线逐行扫描图像出现问题时，我们建议您将连接切换到“标准清晰度”输出。如果出现有关视频监视器与本型号 525P 和 625P DVD 播放机兼容的问题，请与我们的客户服务中心联系。

本机兼容 Yamaha 这一系列的各产品，包括 DPX-1300，DPX-830 以及等离子监视器 PDM-4220。

调节图像设置

本机具有 3 种预先定义的图像色彩设置组合，您可以自行定义 1 种个人设置。

- 1 在“视频设定页”，按下 ▲/▼ 以高亮度显示 [画质设定]，然后按下 ►。

标准

选择此项以使用标准图像设置。

亮度

选择此项使得电视图像更亮。

柔和

选择此项使得电视图像更柔和。

个人

选择此项使得图像色彩个性化，可调节亮度，对比度，色度和色彩（饱和度）。

- 2 按下 ▲/▼ 选择一种设置，然后按下 ENTER。
- 3 如果您在步骤 1 选择 [个人]，前进到 4-7。
→ “个性化图像设定”菜单出现。



- 4 按下 ▲/▼ 选择下列选项之一。

亮度

增加或减少数值使图像变得更亮或更暗。零 (0) 是平均的亮度设置数值。

对比度

增加或减少数值使图像变得更尖锐或更空泛。零 (0) 是平均的对比度设置数值。

色调

增加或减少数值使图像发暗或变亮。零 (0) 是平均的色调设置数值。

饱和度

增加或减少数值使图像增色或退色。零 (0) 是平均的色彩设置数值。

- 5 按下 ◀/▶ 调节各设置以最大限度地符合您的个人喜好。
- 6 反复步骤 4-5 调节其他颜色特性。
- 7 按下 ENTER。

注

所有图像设置对于 HDMI 输出无效。

设置 HDMI 视频

当您通过 HDMI 插孔将本机连接到 HDMI 兼容的组件机时，根据所连接的组件机选择下列视频输出设置。

- 1 在“视频设定页”，按下 ▲/▼ 以高亮度显示 [HDMI 设置]，然后按下 ►。
- 2 按下 ▲/▼ 以高亮度显示一个选项。
- 3 按下 ► 进入一个子菜单。

宽荧幕格式

设置屏幕上放映图像的宽高比。仅当进行 HDMI 连接以及 [电视机形式] 被设置为 [宽荧幕] 时，该功能有效（请参阅第 27 页）。

非线性拉伸

使用非线性拉伸在 16:9 屏幕显示 4:3 图像时选择该项（屏幕的中央部分比外侧拉伸的程度小）。当分辨率被设置为 480p 和 576p 时，该功能无效。

4:3 信箱模式

不使用拉伸在 16:9 屏幕显示 4:3 图像时选择该项。当播放以 16:9 图像录制的碟片时，图像以原来的宽高比 (16:9) 显示，不使用信箱格式。

关

当该项被选择时不进行宽高比调节。

HDMI 视频

根据您所使用的监视器设置分辨率。

480P

480 逐行扫描视频

576P

576 逐行扫描视频

720P

720 逐行扫描视频

1080I

1080 隔行视频

自动

根据您所使用的监视器，分辨率被自动选择。

注

- 对于 [自动] 以外的设置，如果您所使用的 HDMI 组件机不支持分辨率输出设置，HDMI 信号也许不能妥当输出。在此情形下，按以下步骤返回初始设置。

- 1 按下前面板的 OPEN/CLOSE (△)，打开碟片托盘。

- 2 按下 ◀。

- 3 按下 SUBTITLE。

在本机播放碟片时，不要进行此操作。

- 当进行 HDMI 连接时，您不能设置 [电视机制式] 和 [逐行]。
- 当 HDMI 连接断开时，[电视机制式] 的设置可以改变。如果分量视频，S-视频或复合视频不能正确输出，请参阅第 34 页上的“故障排除”在此设置正确的电视机类型。

高清 JPEG

当连接到 HDMI 组件机时，本机可显示高分辨率 JPEG 图形。

开

显示高质量的 JPEG 图形。

关

显示标准质量的 JPEG 图形。

注

- 当 720p 或 1080i 的 HDMI 视频信号被输出时，您可以选择 [高清 JPEG]。
- 当 [高清 JPEG] 设置为 [开] 且 HD JPEG 图形被显示时，HDMI 以外的视频信号不能输出。
- 当 HD JPEG 图像显示时，您不能选择 [HDMI 视频] 和 [高清 JPEG]。

设置菜单

喜好设置菜单

- 1 按下 **■** 两次，停止播放（如果必要），然后按下 **SET UP**。
- 2 按下 **◀/▶**，选择“初期设定页”。
- 3 按下 **ENTER**。

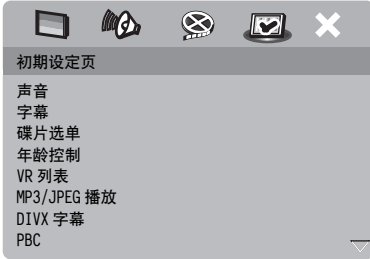

音频，字幕以及碟片菜单

这些菜单包括许多用于音频，字幕以及录制在 DVD-视频上的碟片菜单等的语言设置。有关详情，请参阅第 14 页上的“设置音频，字幕以及碟片菜单语言（仅限于 DVD 视频）”。

父母控制的限制播放

某些 DVD 的父母控制水平针对整个碟片，而有些则针对某些场景。利用这些功能您可以设置播放限制水平。限制水平从 1 到 8，且根据国家而变。您可以限制一些对小孩不宜的碟片，也可以在某些碟片中使其播放替代的场景。

- 1 在“初期设定页”，按下 **▲/▼**，以高亮度显示 [年龄控制]，然后按下 **▶**。

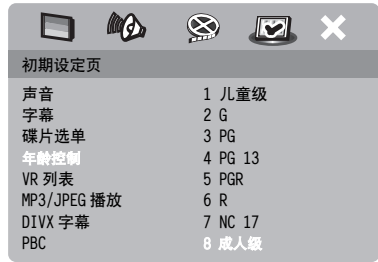

- 2 按下 **▲/▼**，以高亮度显示限制水平，然后按下 **ENTER**。
 - 要取消父母控制，使得所有碟片可以播放，选择 [8 成人级]。
- 3 使用数字按钮 (0-9) 键入 6 位数密码（请参阅第 32 页上的“改变密码”）。
 - 限制水平高于您所选择的水平的 DVD 不能播放，除非键入 6 位数密码。

注

有些 DVD 碟片的封套上标注有限制水平，但碟片中实际上并没有植入限制水平密码。限制水平功能对这样碟片的播放无效。

选择 VR 格式的播放

VR (Video Recording) 格式有两种播放方式：原始和播放列表。非 VR 格式的碟片没有此功能。

- 1 在“初期设定页”，按下 **▲/▼** 以高亮度显示 [VR 列表]，然后按下 **▶**。

原始列表

选择该项以播放碟片上原始录制的标题。

播放列表

选择该项以播放经过编辑的碟片。仅当播放列表生成时，该功能有效。

2 按下 ▲/▼ 高亮度显示一种设置，然后按下 ENTER。

■ 要播放 VR 格式的碟片

3 按下 SET UP 关闭设置菜单。

4 按下 ►/⏸，按您所选择的设置，开始播放碟片。

选择 MP3/JPEG 菜单

仅当碟片录制有菜单时，MP3/JPEG 导航器才可设置。它可以引导您方便地选择各种显示菜单。

1 在“初期设定页”，按下 ▲/▼，以高亮度显示 [MP3/JPEG 播放]，然后按下 ►。

顺序播放

选择此项显示 MP3/ 图像 CD 中的所有文件。

菜单播放

选择此项仅显示 MP3/ 图像 CD 中的文件夹菜单。

2 按下 ▲/▼，选择一个设置，然后按下 ENTER。

显示 DivX 外部字幕文件

以下列出的字体可以用于 DivX 外部字幕文件。该设置使得您可以使用匹配的字体在屏幕上显示字幕文件。

1 在“初期设定页”，按下 ▲/▼，以高亮度显示 [DIVX 字幕]，然后按下 ►。

组 1:

阿尔巴尼亚 (sq)，巴斯克 (eu)，加泰罗 (ca)，丹麦 (da)，荷兰 (nl)，英 (en)，法罗斯 (fo)，芬兰 (fi)，法 (fr)，德 (de)，冰岛 (is)，爱尔兰 (ga)，意大利 (it)，挪威 (no)，葡萄牙 (pt)，利托-罗曼 (rm)，苏格兰 (gd)，西班牙 (es)，瑞典 (sv)

组 2:

阿尔巴尼亚 (sq)，克罗地亚 (hr)，捷克 (cs)，匈牙利 (hu)，波兰 (pl)，罗马尼亚 (ro)，斯洛伐克 (sk)，斯洛文尼亚 (s1)

组 3:

保加利亚 (bg)，白俄罗斯 (be)，马其顿 (mk)，俄 (ru)，塞尔维亚 (sr)，乌克兰 (uk)

组 4:

希伯来 (iw)，依地 (ji)

组 5:

土耳其 (tr)

2 按下 ▲/▼，然后按下 ENTER。

注

- 根据碟片特性或录制条件，有些碟片可能无法播放。
- 有些外部字幕文件也许不能正确显示或完全无法显示。
- 对于外部字幕文件，以下的扩展名可以接受（注意，这些文件在碟片的导航菜单上不会显示）：.srt, .sub, .ssa, .smi
- 电影文件的名称必须出现在外部字幕文件的最前头。
- 对于同一个电影文件，可供切换的字幕文件数目不超过 10 个。

设置菜单

选择 PBC（播放控制）功能

您可以设置播放控制（PBC）到打开或关闭。仅限于具有播放控制（PBC）性能的 VCD 2.0 时该功能有用。

- 1 在“初期设定页”，按下 ▲/▼ 以高亮度显示 [PBC]，然后按下 ►。

开

要显示碟片菜单，选择此项。

关

不要显示碟片菜单，选择此项。从碟片的开头开始播放。

- 2 按下 ▲/▼ 选择一种设置，然后按下 ENTER。

注

您也可以使用遥控器上的 MENU 按钮，开启或关闭播放控制（PBC）性能（请参阅第 18 页上的“使用播放控制（PBC）菜单”）。

改变密码

父母控制和碟片锁定使用相同的密码。当屏幕上有指示时，键入 6 位密码。默认密码是“000 000”。

- 1 在“初期设定页”，按下 ▲/▼，高亮度显示 [密码]，然后按下 ►，选择 [改变]。

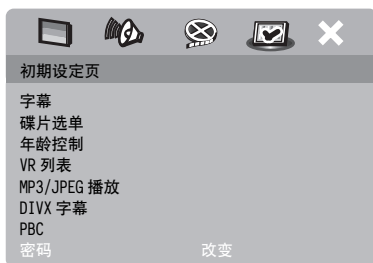

- 2 按下 ENTER 进入“密码更改页面”。



- 3 使用数字按钮（0-9）键入旧的 6 位数密码。

- 如果是第一次，请键入“000 000”。
- 如果您忘记了 6 位数密码，请键入“000 000”。

- 4 请键入新的 6 位数密码。

- 5 请再次键入新的 6 位数密码以确认该密码。

- 6 按下 ENTER 确定新密码。

→ 新的 6 位数密码生效。

系统复位

您可以复位所有的选项和个人设置返回到出厂设置，但是 [年龄控制] 和 [锁碟] 除外。

- 1 在“初期设定页”，按下 ▲/▼ 以高亮度显示 [缺省值]，然后按下 ► 选择 [复原]。

- 2 按下 ENTER。

→ 所有设置返回到出厂的默认值。

这些编码可以用来选择其他语言。这不会影响“声音”，“字幕”或“碟片选单”的各个选项。

阿布哈西亚语	6566	盖尔语	7168	马其顿语	7775	撒丁语	8367
阿法尔语	6565	加利西亚语	7176	马达加斯加语	7771	苏格兰盖尔语	7168
南非荷兰语	6570	格鲁吉亚语	7565	马来语	7783	塞尔维亚语	8382
阿尔巴尼亚语	8381	德语	6869	马拉雅拉姆语	7776	绍纳语	8378
阿姆哈拉语	6577	基库尤语	7573	马耳他语	7784	信德语	8368
阿拉伯语	6582	希腊语	6976	马恩岛语	7186	僧加罗语	8373
亚美尼亚语	7289	瓜拉尼语	7178	毛利语	7773	斯洛伐克语	8375
阿萨姆语	6583	古吉拉特语	7185	马拉提语	7782	斯洛文尼亚语	8376
阿维斯陀语	6569	豪萨语	7265	马绍尔语	7772	索马里语	8379
艾马拉语	6589	希伯来语	7269	摩尔达维亚语	7779	南索托语	8384
阿塞拜疆语	6590	赫雷罗语	7290	蒙古语	7778	南恩德贝勒语	7882
巴什基尔语	6665	印地语	7273	瑙鲁语	7865	西班牙语	6983
巴斯克语	6985	希里莫图语	7279	纳瓦霍语	7886	巽他语	8385
白俄罗斯语	6669	匈牙利语	7285	纳瓦霍语	7886	斯瓦希里语	8387
孟加拉语	6678	冰岛语	7383	北恩德贝勒语	7868	斯瓦特语	8383
比哈尔语	6672	伊多语	7379	南恩德贝勒语	7882	瑞典语	8386
比斯拉玛语	6673	印尼语	7368	恩敦加语	7871	他加禄语	8476
挪威布克莫尔语	7866	国际语 A	7365	尼泊尔语	7869	塔希提语	8489
波斯尼亚语	6683	国际语 E	7369	北萨莫斯语	8369	塔吉克语	8471
布列塔尼语	6682	伊努伊特语	7385	北恩德贝勒语	7868	泰米尔语	8465
保加利亚语	6671	依努庇克语	7375	挪威语	7879	塔塔尔语	8484
缅甸语	7789	爱尔兰语	7165	挪威布克莫尔语	7866	泰卢固语	8469
西班牙语	6983	意大利语	7384	新挪威语	7878	泰语	8472
加泰隆语	6765	日语	7465	尼扬贾语	7889	藏语	6679
查莫罗语	6772	爪哇语	7486	新挪威语	7878	捷格里尼亚语	8473
车臣语	6769	格陵兰语	7576	奥克西唐语 (1500 以后)	7967	汤加语 (汤加岛)	8479
切瓦语	7889	坎纳达语	7578	旧保加利亚语	6785	宗加语	8483
奇切瓦语	7889	克什米尔语	7583	教会斯拉夫语	6785	塞茨瓦纳语	8478
汉语 (中文)	9072	哈萨克语	7575	教会斯拉夫语	6785	土耳其语	8482
壮语	9065	高棉语	7577	奥利亚语	7982	土库曼语	8475
教会斯拉夫语	6785	基库尤语	7573	奥洛莫语	7977	特威语	8487
教会斯拉夫语	6785	基尼阿万达语	8287	奥塞梯语	7983	维吾尔语	8571
楚瓦什语	6786	吉尔吉斯语	7589	奥塞梯语	7983	乌克兰语	8575
康沃尔语	7587	科米语	7586	巴利语	8073	乌尔都语	8582
科西嘉语	6779	朝鲜语	7579	旁遮普语	8065	乌兹别克语	8590
克罗地亚语	7282	夸尼亚玛语	7574	波斯语	7065	越南语	8673
捷克语	6783	库尔德语	7585	波兰语	8076	沃拉普克语	8679
丹麦语	6865	夸尼亚玛语	7574	葡萄牙语	8084	沃伦语	8765
荷兰语	7876	老挝语	7679	奥克西唐语	7967	威尔士语	6789
不丹语	6890	拉丁语	7665	普什图语	8083	沃洛夫语	8779
英语	6978	拉脱维亚语	7686	凯楚亚语	8185	科萨语	8872
世界语	6979	列茨巴戈语	7666	罗曼斯方言	8277	依地语	8973
爱沙尼亚语	6984	林巴戈语	7673	罗马尼亚语	8279	约鲁巴语	8979
法罗斯语	7079	林巴戈语	7673	基隆迪语	8278	壮语	9065
斐济语	7074	林巴戈语	7673	俄语	8285	祖鲁语	9085
芬兰语	7073	林加拉语	7678	萨摩亚语	8377		
法语	7082	立陶宛语	7684	桑戈语	8371		
弗里斯兰语	7089	卢森堡语	7666	梵语	8365		

故障排除

当本机工作不正常时，请参阅下面的表。如果您遇到的问题没有列在下面，或如果下面给出的指导不起作用，请将本机设为待机模式，断开电源导线，并联络距离您最近的 Yamaha 经销商或服务中心。

问题	解决方法
无电源	正确连接交流电源线。 按下前面板上的 STANDBY/ON 打开电源。
无图像	请参考您的电视机附带的说明书，选择正确的视频输入频道。切换电视频道，直到您看到 DVD 的屏幕。 打开电视机。 检查视频连接。 当 HD JPEG 图形被显示时，HDMI 以外的视频信号不能输出（请参阅第 29 页上的“高清 JPEG”）。
当您进行 HDMI 连接（使用 HDMI 插孔）时，没有图像显示	按以下步骤改变 [HDMI 视频] 到 [自动]。 1. 按下前面板的 OPEN/CLOSE (△) 或按住遥控器的 ■，打开碟片托盘。 2. 按下遥控器上的 ◀。 3. 按下遥控器上的 SUBTITLE。
当您没有使用逐行扫描连接（使用分量视频插孔）时，没有图像显示	通过以下步骤关闭逐行扫描功能。 1. 按下前面板的 OPEN/CLOSE (△) 或按住遥控器的 ■，打开碟片托盘。 2. 按下遥控器上的 ◀。 3. 按下遥控器上的 ZOOM，使得逐行扫描无效。
完全扭曲的图像，或黑白图像，或无图像	检查碟片是否与本站兼容（请参阅第 3 页上的“可播放碟片格式”）。 检查本机的电视机类型设置是否与碟片和电视机相匹配（请参阅第 13 页上的“设置电视机的色彩系统”）。按以下步骤改变 [电视机制式] 的设置。 1. 按下前面板的 OPEN/CLOSE (△) 或按住遥控器的 ■，打开碟片托盘。 2. 按下遥控器上的 ▶。 3. 按下遥控器上的 AUDIO。
图像失真	对于某些碟片，播放时在一个小区域内可能偶尔出现图像失真。这不是故障。
屏幕大小看起来不自然，或电视机监视器上字幕只显示一部分或者全部不显示	检查本机的电视机设置是否匹配电视机的屏幕大小（请参阅第 27 页上的“设置电视机显示”）。 改变屏幕大小和电视机的宽高比。

问题	解决方法
没有声音或声音失真	调节音量水平。
	检查扬声器连接是否正确。
	对于 MP3/WMA，检查取样率和比特率是否与本机兼容（请参阅第 39 页上的“规格”）。
数码输出无声音	检查数码连接。
	如果您播放 DTS 音源，检查您的接收机是否可以解码 DTS 以及 [数字输出] 是否被设置到 [全部]（请参阅第 25 页）。
	如果您正在播放 MPEG-2 音源，检查您的接收机是否可以解码 MPEG-2。否则，检查 [数字输出] 被设置到 [MPEG → PCM]（请参阅第 25 页）。
	检查选择的音频语言的音频格式是否匹配您的接收机性能。
碟片不播放	CD-R/RW, DVD+R/RW/R DL 和 DVD-R/RW/R DL 必须经过封尾处理。
	检查碟片标签的朝向。
	用尝试另外的碟片的方法检查现在碟片是否有缺陷。
	如果您自行录制 JPEG, MP3 或 WMA 碟片，检查您的碟片是否至少包含 10 个 JPEG 图像文件或 5 首 MP3/WMA 音乐曲目。
	对于 MP3/WMA，检查取样率和比特率是否兼容。对于 JPEG，检查分辨率是否兼容（请参阅第 39 页上的“规格”）。
	检查区域码（请参阅第 3 页上的“区域码”）。
播放时图像突然静止不动	检查碟片表面是否有指纹 / 划伤，使用软布从中央向边缘擦拭清洁碟片。
本机不响应遥控器	将遥控器直接对准前面板上的遥控传感器。
	减小从本机到遥控器的距离。
	更换遥控器电池。
	按照极性 (+/- 符号) 指向再次插入电池。
按钮不工作	要彻底复位本机，请从交流插座上拔下电源线，并等待 5-10 秒。
播放时本机不回应某些操作命令	某些操作也许不被该碟片许可。请参阅碟片封套的说明。
	在 HD JPEG 播放时，▲/▼ 按钮无效。
本机不能读取 CD 或 DVD	在送去修理之前，使用一般的 CD/DVD 镜头清洁剂清洁镜头。

故障排除

问题	解决方法
“NO DISC”出现在前部面板显示器中	检查碟片是否正确放置在托盘中。
“UN DISC”出现在前部面板显示器中	所装载的碟片也许不被本机支持。检查碟片类型（请参阅第 3 页上的“可播放碟片格式”）。
菜单项目不能被选择	在选择设置菜单之前，按下遥控器上的 ■ 两次。
	根据碟片特性的不同，有些菜单项目也许不能选择。
	要选择 [高清 JPEG]，请检查 HDMI 组件机连接是否正确，以及 720p 或 1080i 的 HDMI 视频信号是否输出。
HD JPEG 图像不能显示	检查 [高清 JPEG] 是否被设置到 [开]（请参阅第 29 页）。
	碟片的读取时间可能超过 30 秒。
	MP3 音乐和 HD JPEG 图像不能同时播放或显示。
当 DivX 电影播放时没有声音	本机也许不支持该音频编码。
USB 装置不能被认知	检查 USB 装置连接是否正确。
	有些 USB 装置虽然是 USB 大容量存储器，但不能工作。
	将本机设置为待机模式，然后再次开启本机。
	当本机为待机模式时拔掉 USB 装置，然后再次连接并打开本机。
	如果装置附带有 AC 适配器连接该适配器。
	如果“该设备不受支持。”出现在电视机屏幕中，检查该装置是否被本机支持（请参阅第 21 页上的“所支持的 USB 装置”）。
如果“USB 当前已被写保护。该设备不受支持。”出现在电视机屏幕中，则该装置不能在本机播放（请参阅第 21 页）。	

■ 模拟

未被转换成数字数值的音响。模拟音响具有变化；而数字音响具有特定的数值。这些插孔通过两个声道，左和右，传送音频。

■ 宽高比

显示的图像的水平和垂直尺寸的比例。普通电视机的水平和垂直尺寸之比为4:3，而宽荧幕为16:9。

■ 音频输出插孔

位于DVD播放机背面的插孔，传送音频到别的系统（电视机，立体声等）。

■ 比特率

用来容纳给定的音乐长度的数据量；以每秒千比特，kbps度量。还有，您录制时的速度。一般地，比特率越高，或速度越快，声音的质量越好。但是，高的比特率使用更多的碟片空间。

■ 章节

在DVD之中小于标题的图像或音乐部分。标题由几个章节构成。每个章节具有章节号码以便于查找定位。

■ 分量视频输出插孔

位于DVD播放机背面的插孔，传送高质量视频到电视机，当然，电视机具有对应的分量输入插孔（R/G/B, Y/Pb/Pr等）。

■ 碟片菜单

一个显示屏幕，通过它用户可以选择录制在DVD上的图像，音响，字幕，多角度等信息。

■ 数码

被转换成数字数值的音响。当您使用数码音频插孔时就可以得到数码音响。这些插孔通过多个声道传送音频，而不像模拟音响那样，只有两个。

■ DivX

DivX是一项由DivX公司发明的，有人气的媒体压缩技术。DivX媒体文件包含高度压缩的视频，具有极为逼真的视觉效果而只需要一个很小的文件。DivX文件也可以包括先进的媒体性能诸如菜单，字幕，和更替音频曲目。许多DivX媒体文件可以在线下载，使用DivX.com提供的实用工具，您可以从自己私人的材料创建您自己的DivX。

■ DivX Ultra

DivX Ultra认证的产品提供加强的方式播放DivX媒体格式支持的高级媒体功能。主要功能包括交互式视频菜单，字幕，更换音轨，视频标签以及章节点等。

■ DMF (DivX 媒体格式)

DivX媒体格式支持高级的媒体功能，可以实现交互式媒体控制：交互视频菜单，章节点，多种语言，字幕以及更换音轨等。

■ Dolby Digital

Dolby Laboratories开发的环境声系统，包含6个数码音频声道（左和右，环绕声左和右，中央以及超低音）。

■ DTS

数字影院系统。这是一种与Dolby Digital不同的环绕声系统。其格式为不同的公司所开发。

■ HDMI

HDMI（高分辨率多媒体界面）是第一个业界支持的，非压缩，全数码A/V（音频/视频）界面。可提供任意A/V源（比如顶置盒或A/V接收机）和音频/视频监视器（比如数码电视-DTV）之间的界面，HDMI仅使用一根缆线，支持标准的，加强的或高分辨率的视频以及多声道音频。HDMI传输所有ATSC HDTV标准，支持8-声道数码音频，其带宽还足以满足未来的增强或其他要求。如果与 HDCP（High-bandwidth Digital Content Protection）联合使用，HDMI可提供安全的音频/视频界面，可以满足供应商和系统操作的安全要求。有关HDMI的详情，请参看HDMI的网页，“www.hdmi.org/”。

■ HDCP

HDCP（High-bandwidth Digital Content Protection）是Intel公司开发的，是一种对数码音频和视频数据加密的技术，可用于内容保护。有关HDCP的详情，请参看HDCP的网页，“www.digital-cp.com”。

■ HD JPEG

HD（High-Definition）JPEG是具有极高的分辨率的图像，可通过HDMI连接实现。

术语

■ 交互式菜单

交互式视频菜单提供了空前方便的途径用来快速浏览各种场景和附带的功能，并选择音轨和字幕选项。

■ JPEG

一种非常普遍的数码静止图像格式。这是 Joint Photographic Expert Group 提出的一种静止图像数据压缩方法，虽然压缩比率高，但是图像质量有少许损失。

■ MP3

音响数据压缩系统的一种文件格式。“MP3”是 Motion Picture Experts Group 1 (or MPEG-1) Audio Layer 3 的缩写。使用 MP3 格式，一张 CD-R 或 CD-RW 可以容纳普通 CD 碟片 10 倍的数据。

■ 父母控制

这是 DVD 的一种功能，可以根据用户的年龄或各个国家的规定对碟片的播放进行限制。限制因碟片的不同而异；如果该功能被启动，碟片的级别如果超过设定的级别，播放就被禁止。

■ PCM (Pulse Code Modulation)

一种将模拟音响信号转换成数码信号以便于后续处理的系统，在转换时不进行数据压缩。

■ 播放控制 (PBC)

参考录制在 CD 或 SVCD 上的信号来控制播放。使用录制在支持 PBC 的 CD 或 SVCD 上的菜单屏幕，您可以交互式地欣赏内容以及使用搜索功能。

■ 播放清单

按一定次序播放的被选择标题的清单。该功能仅限于 VR 格式，且必须事先制作。

■ 逐行扫描

作为一个信号帧，一次显示构成图像的所有水平线。本系统可以将 DVD 的隔行扫描视频转换成逐行扫描格式，传送到所连接的逐行显示器上。这可以显著增加竖直分辨率。

■ 区域码

一种限制碟片仅在特定区域使用的事先规定好的系统。本机仅播放具有兼容的区域码的碟片。您可以在产品铭牌上找到本机的区域码。有些碟片可以用于多个区域（或 ALL 区域）。

■ S-视频

将亮度和色度信号分别传送从而可以得到更清晰的图像。仅当您的电视机具有 S-视频插孔时可以使用 S-视频。

■ 环绕声

在听音者周围放置多个扬声器，从而产生逼真的三维声场的一种系统。

■ 标题

DVD，音乐碟片，视频软件，音乐软件的整个集中最长的图像或音乐片断。每个标题具有标题号码以便于查找定位。

■ 音频输出插孔

位于 DVD 播放机背面的插孔，传送视频到电视机。

■ VR (Video Recording) 格式

一种可以制作用来再次编辑的 DVD 的格式。

可播放碟片格式

- DVD- 视频
- DVD-R, DVD-RW, DVD+R DL
- DVD+R, DVD+RW, DVD+R DL
- VCD, SVCD
- CD
- 图像 CD
- CD-R, CD-RW
- MP3 (ISO 9660)fs 32, 44.1, 48 kHz / 96, 128, 256, 320 kbps (仅限于 CBR)
- WMAfs 44.1 kHz, 62-192 kbps (仅限于 CBR) / fs 48 kHz, 128-192 kbps (仅限于 CBR)
- DivX
- JPEG3072 x 2048 dpi 或更小

视频性能

- 视频 (CVBS) 输出1 Vpp 到 75 ohm
- S- 视频输出Y: 1 Vpp 到 75 ohm
C: 0.3 Vpp 到 75 ohm
- 分量视频输出Y: 1 Vpp 到 75 ohm
Pb Pr: 0.7 Vpp 到 75 ohm
- RGB (Scart) 输出 (仅限于英国和欧洲型号)
..... Y: 0.7 Vpp 到 75 ohm

音频格式

- 数码
Dolby Digital, DTS, MPEG压缩数码
PCMfs 44.1, 48, 96 kHz / 16, 20, 24 bits
- 模拟音响立体声

音频特性

- DA 转换器24 bit
- 信号-噪音 (1 kHz)105 dB
- 动态范围 (1 kHz)97 dB
- DVDfs 96 kHz, 2 Hz-44 kHz / fs 48 kHz, 2 Hz-22 kHz
- SVCDfs 48 kHz, 2 Hz-22 kHz / fs 44.1 kHz, 2 Hz-20 kHz
- CD, VCDfs 44.1 kHz, 2 Hz-20 kHz
- 失真和噪音 (1 kHz)0.0035%

多媒体应用

- 连接USB 大容量存储器
- 播放格式 (USB 装置)
MP3fs 32, 44.1, 48 kHz / 96, 128, 256, 320 kbps (仅限于 CBR)
WMA fs 44.1 kHz, 62-192 kbps (仅限于 CBR) / fs 48 kHz, 128-192 kbps (仅限于 CBR)
DivX3 Mbps 或更小
JPEG3072 x 2048 dpi 或更小

电视规格

- 线数PAL: 625, NTSC: 525
- 垂直频率PAL: 50 Hz, NTSC: 60 Hz
- 播放多制式 (PAL/NTSC)

连接

- 视频输出RCA/Phono x 1 (黄色)
- S- 视频输出微型 DIN, 4 针 x 1
- 分量视频输出
Y 输出RCA/Phono x 1 (绿色)
Pb 输出RCA/Phono x 1 (蓝色)
Pr 输出RCA/Phono x 1 (红色)
- SCART (仅限于英国和欧洲型号)
Euroconnector x 1
- 音频输出 (L+R)
..... RCA/Phono x 1 对 (白色/红色)
- 数码输出
同轴RCA/Phono x 1
(IEC60958, 对于 CDDA, LPCM / IEC61937, 对于 MPEG 1/2, Dolby Digital, DTS)
HDMI类型 A x 1
- USB类型 A x 1
- 遥控器
输入 ϕ 3.5 mm 微型插孔 x 1
输出 ϕ 3.5 mm 微型插孔 x 1

包装箱

- 尺寸 (宽×深×高)435 × 310 × 51 mm
- 重量大约 2.6 kg

电源

- 电源插孔
美国和加拿大型号AC 120 V, 60 Hz
英国和欧洲型号AC 230 V, 50 Hz
澳大利亚, 亚洲, 中美洲和南美洲型号
.....交流 110-240 V, 50 Hz/60 Hz
韩国型号AC 110-240 V, 60 Hz
- 功耗大约 14 W
- 待机功耗小于 1 W

激光

类型	半导体激光 GaAlAs
波长	650 nm (DVD) 780 nm (VCD/CD)
输出功率	7 mW (DVD) 10 mW (VCD/CD)
光束发散	60 度

规格时有变化, 恕不另行通知。



©2007 YAMAHA CORPORATION All rights reserved.

YAMAHA ELECTRONICS CORPORATION, USA 6660 ORANGETHORPE AVE., BUENA PARK, CALIF. 90620, U.S.A.

YAMAHA CANADA MUSIC LTD. 135 MILNER AVE., SCARBOROUGH, ONTARIO M1S 3R1, CANADA

YAMAHA ELEKTRONIK EUROPA G.m.b.H. SIEMENSSTR. 22-34, 25462 RELLINGEN BEI HAMBURG, GERMANY

YAMAHA ELECTRONIQUE FRANCE S.A. RUE AMBROISE CROIZAT BP70 CROISSY-BEAUBOURG 77312 MARNE-LA-VALLEE CEDEX02, FRANCE

YAMAHA ELECTRONICS (UK) LTD. YAMAHA HOUSE, 200 RICKMANSWORTH ROAD WATFORD, HERTS WD18 7GQ, ENGLAND

YAMAHA SCANDINAVIA A.B. J Å WETTERGRENS GATA 1, BOX 30053, 400 43 VÄSTRA FRÖLUNDA, SWEDEN

YAMAHA MUSIC AUSTRALIA PTY, LTD. 17-33 MARKET ST., SOUTH MELBOURNE, 3205 VIC., AUSTRALIA

YAMAHA CORPORATION

Printed in China C 3139 245 26141