



RX-A3000

AV Receiver

Owner's Manual

English for U.S.A.

BEFORE USE

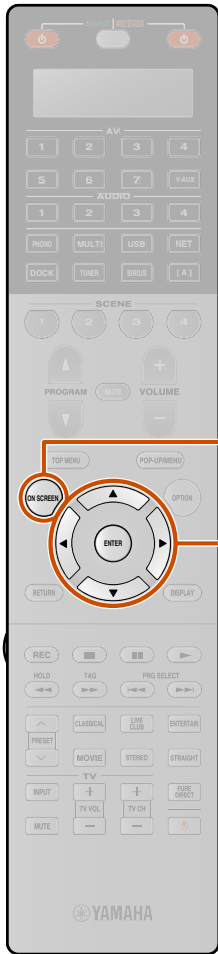

About this manual

- Some features are not available in certain regions.
- This manual is created prior to production. Design and specifications are subject to change in part as a result of improvements, etc. In case of differences between the manual and product, the product has priority.
- “[8]ON SCREEN” (example) indicates the name of the parts on the remote control. Refer to the “Remote control” (p. 12) for the information about each position of the parts.
- indicates that the reference is in the footnote. Refer to the corresponding numbers on the bottom of the page.
- indicates the page describing the related information.
- Click on the “ ” at the bottom of the page to display the corresponding page in “Part names and functions.”

- Front panel
- Rear panel
- Front panel display
- Remote control

Supplied accessories

Check that you received all of the following parts.

- Remote control
- Simplified Remote Control
- Batteries (AAA, LR03, UM-4) x 4
- Power cable
- YPAO microphone
- AM loop antenna
- Indoor FM antenna
- Microphone base

Language selection

This procedure allows you to select the language of menus and messages on the TV screen.

- 1 Press [8]ON SCREEN to display the ON SCREEN menu.

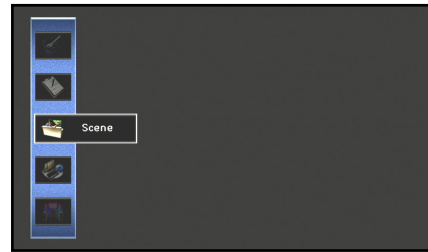

- 2 Press [9]Cursor Δ / ∇ to select “Setup” and press [9]ENTER.

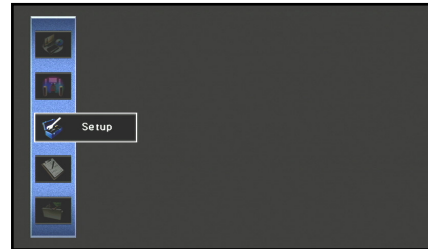

- 3 Press [9]Cursor \leftarrow / \rightarrow to select the “Language” and press [9]ENTER.

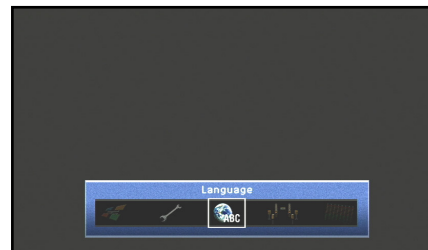

- 4 Press [9]Cursor Δ / ∇ to select the favorite language from the following options.

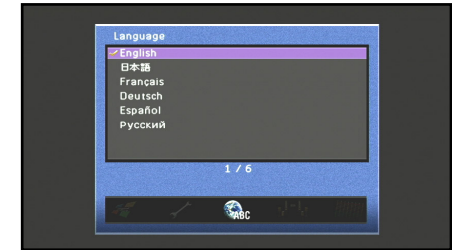

English (English), 日本語 (Japanese), Français (French), Deutsch (German), Español (Spanish), Русский (Russian)

- 5 Press [8]ON SCREEN to close the ON SCREEN menu.



CONTENTS

INTRODUCTION

Features and capabilities	5
Using the TV OSD to operate the unit	6
Basic operation of OSD menu	6
Viewing or modifying content for the current input source <Content window>	6
Configuring settings for this unit <ON SCREEN menu>	6
Adjust settings for each input source <Option menu>	7
Part names and functions	8
Front panel	8
Front panel with the cover opened	9
Rear panel	10
Front panel display	11
Remote control	12
Remote control with the cover opened	13
On-screen display	14

CONNECTIONS

Connecting speakers	15
Speaker channels and functions	15
Speaker layout	16
Connecting speakers and subwoofers	20
Advanced speaker configuration	24
Speaker layout utilizing an external power amplifier	24
Connecting an external amplifier	28
Connecting external components	29
Jacks and cables	29
Connecting a TV monitor	30
Connecting BD/DVD players and other devices	33
Connecting game consoles or video camcorders	38
Connecting a multi-format player or an external decoder	38
Connecting a SCENE link playback-compatible device	39

Using the Trigger function to link external component power	39
Connecting audio/video recording devices	40
Connecting to the network	40
Connecting a USB storage device	41

Connecting the FM/AM antennas

Setting up the speaker parameters automatically (YPAO)

PLAYBACK

Basic playback procedure

Changing input settings with a single key (SCENE function)

Selecting the SCENE suitable for the external component	54
--	----

Enjoying favorite sound field effect

Selecting sound programs and sound decoders	55
Enjoying surround sound with the CINEMA DSP function	55
Enjoying unprocessed playback (Straight decoding mode)	56
Enjoying Hi-Fi Sound Quality (Pure Direct Mode)	57
Enjoying stereo playback	57
Enjoying compressed music source with better sound quality (Compressed Music Enhancer)	57
Sound programs	58

Using the TV display to control this unit

Basic operations via the TV screen display	60
--	----

Configuring settings specific to an individual input source (Option menu)

Option menu display and setup	62
Option menu	63

Confirming and operating input sources from the content window

Displaying the content window on the TV screen	66
Switching the display between the Now Playing view and the Browse view	66

FM/AM tuning

Selecting a frequency for reception (Normal tuning)	67
Navigating the FM/AM tuner from the content window	68

Listening to the HD Radio™

Selecting HD Radio™ audio programs	70
Using the iTunes Tagging	71
Displaying the HD Radio™ information	71
Navigating the HD Radio™ tuner from the content window	72

Listening to the SIRIUS Satellite Radio™

Connecting the SiriusConnect™ tuner	74
Activating SIRIUS Satellite Radio™ subscription	75
SIRIUS Satellite Radio™ operations	75
Registering and recalling the SIRIUS Satellite Radio™ channels	76
Displaying the SIRIUS Satellite Radio™ information	77
Navigating the SIRIUS Satellite Radio™ tuner from the content window	78

Playing back tunes on the PC

Windows Media Player setup	80
Playback of PC music contents	80

Playing back tunes on the USB storage devices

Playback of the USB storage device	82
--	----

Listening to the Internet Radio

Listening to Internet Radio	84
-----------------------------------	----

Using the Rhapsody® service

Rhapsody® account sign-in	86
Playback of Rhapsody® contents	87

Listening to the SIRIUS Internet Radio

SIRIUS Internet Radio account sign-in	90
Navigating the Sirius Internet Radio menu	91

Using shortcut function

Playing back tunes from your iPod™/iPhone™

Connecting the Universal Dock for iPod	94
Controlling an iPod™/iPhone™	94

Playing iPod™/iPhone™ from the menu screen (Menu browse control)	95
Operating basic playback functions via the remote control (Simple remote control)	96
Playing iPod™/iPhone™ with wireless connection.....	96
Playing back tunes from Bluetooth™ components.....	98
Connecting a Yamaha Bluetooth Wireless Audio Receiver.....	98
Pairing Bluetooth™ components.....	98
Using Bluetooth™ components	99
Controlling this unit by using the Web browser (Web Control Center)	100
Displaying and Operating Web Control Center.....	100

SETUP

Configuring input sources (Input menu)	102
Configuring input sources	102
Input menu.....	103
Editing the SCENE function (Scene menu)	106
Editing a scene.....	106
Scene menu.....	107
Simple registering as the SCENE.....	108
Setting sound program parameters (Sound Program menu)	109
Editing sound programs.....	109
CINEMA DSP parameters	110
Parameters usable in certain sound programs	112
Parameters usable in surround decoder	113
Setting various functions (Setup menu)	114
Operating the Setup menu	114
Setup menu	115
Manages settings for speakers.....	115
Setting the audio output function of this unit	119
Setting this unit's video output function.....	121
Setting HDMI functions	123
Adjusting this unit's network parameters	125
Setting this unit's multi-zone function	126
Making the receiver easier to use	128

Language	131
Confirming information of this unit (Information menu)	132
Selecting information	132
Controlling the remote control to operate various functions	134
Keys connecting external components	134
Customizing the remote control	135
Setting remote control codes	135
Programming from other remote controls	137
Changing source names in the display window	139
Macro programming features	140
Clearing configurations	141
Simplified remote control.....	143
Extended functionality that can be configured as needed (Advanced Setup menu).....	144
Displaying/Setting the Advanced Setup menu.....	144
Setting the impedance of speakers	144
Remote sensor	145
Avoiding crossing remote control signals when using multiple Yamaha receivers	145
Resetting the SIRIUS Satellite Radio™ parental lock code.....	146
Changing TV format	146
Removing HDMI video output up-scaling limits.....	146
Recovery and backup of the system settings.....	146
Initializing various settings for this unit.....	147
Firmware update.....	147
Firmware version.....	147
Using the HDMI Control function	148
Enjoying the contents in another room	152
Connecting Zone2, Zone3 or Zone4	152
Controlling Zone2, Zone3 or Zone4	154
Enjoying the music in all rooms.....	155

APPENDIX

Troubleshooting	156
General.....	156
HDMI™.....	158
Tuner (FM/AM)	159
HD Radio™ Reception	159
iTunes Tagging	160
SIRIUS Satellite Radio™	160
USB and Network	161
iPod™/iPhone™	163
Bluetooth™.....	163
Remote control.....	164
Glossary	165
Audio information.....	165
Sound program information	166
Video information	167
Compatibility of the input and output video signals.....	167
Information on HDMI™.....	168
About trademarks	169
Specifications.....	170
Index	172

INTRODUCTION

Features and capabilities

■ Built-in high-quality, high-power 7-channel amplifier	
■ Multi-channel speaker configuration capability	
– 2- to 7.1-channel speaker configurations	16
– Presence speaker connections for playback with a richer sound field effect	20
– Bi-amplification connections for high-quality playback	21
– External amplifier connections for high-quality playback and expansion of channels	24
– Speaker impedance configuration	21
■ HDMI compatibility	
– 8 HDMI input jacks (7 on the rear, 1 on the front) supporting 3D video signal input	33
– 2 selectable HDMI output jacks supporting Audio Return Channel and 3D video signal	31
■ Automatic setup for speaker acoustic parameters (YPAO - Yamaha Parametric Room Acoustic Optimizer)	43
■ Extensive inputs (max. 13) for external playback components	
– BD/DVD/CD player connection	33
– Game console / video camcorder connection	38
– Multi-format player / external decoder connection	38
– iPod/iPhone wired connection	94
– iPod/iPhone wireless connection	96
– Bluetooth component connection	98
■ 1-button input/sound program/setting switching (SCENE function)	54
■ Built-in sound programs and surround decoders for playback variety of sources	
– Spatial sound playback with sound field effects (CINEMA DSP)	55
– Playback with no sound field effects (straight decoding)	56
– High-fidelity sound playback (Pure Direct)	57
– Enhanced sound playback for compressed sources (Compressed Music Enhancer)	57
■ Tuner playback	
– FM/AM broadcast	67
– HD Radio™ digital broadcast	70
– SIRIUS Satellite Radio™ broadcast	74
■ Playback and control via network	
– Playback of music on the PC and DLNA server	80
– Internet radio service playback	84
– Control this unit via network (Web Browser Control)	100
■ Playback of music on the USB storage devices	82
■ Sophisticated on-screen display (OSD) for easy operation	
– Selection of input sources, scenes, and sound programs	60
– Navigation for the current input source (content window)	66
– Setup for this unit (ON SCREEN menu)	102
– Setup for each input source (Option menu)	62

Most of functions can be operated with on-screen display on the TV screen. Refer to “Using the TV OSD to operate the unit” on the following pages for information on functions that can be controlled using the on-screen display.

■ Customizable remote control	
– Remote control code setup for operation of external components	134
– Learning function from other remote controls	137
– Programming macro for a series of operations	140
■ Multi-room listening capability (Zone2/Zone3/Zone4)	152



Using the TV OSD to operate the unit

This unit features a sophisticated on-screen display (OSD) for the TV screen. The OSD is designed to enable visual guidance that simplifies operations. The OSD mainly displays the ON SCREEN and Option menus, as well as the content window that displays the content of current input sources.

Basic operation of OSD menu

■ Select an input source, scene and sound program	
– Select an input source	60
– Select a scene	60
– Select a sound program	61
■ Select a language	
– Change the language displayed on the TV screen <Language>	131

Viewing or modifying content for the current input source <Content window>

■ Operate the FM/AM tuner, HD Radio or SIRIUS Satellite Radio	
– Display preset stations/channels for selection	68, 72, 78
– Display information on the station/channel currently received	68, 72, 78
– Perform operations such as searching for and registering stations/channels using the screen buttons	68, 72, 78
■ Operate the Internet radio, Rhapsody or SIRIUS Internet Radio	
– Account setup for Rhapsody or SIRIUS Internet Radio	86, 90
– Display information on the station/channel currently received	84, 87, 91
– Play back radio contents	84, 87, 91
– Bookmark Internet radio stations	84
– Add Rhapsody items to “My Library”	88
■ Operate the iPod music sources	
– Display the list of iPod music sources for selection	95
– Perform operations such as play, stop and pause using the TV screen <Menu browse control>	95

Configuring settings for this unit <ON SCREEN menu>

■ Configure an input source	
– Change the input source name <Rename/Icon Select>	103
– Specify a format for digital audio signals <Decoder Mode>	104
– Enhance the sound of compressed audio <Enhancer>	104
– Output a video signal input from another input source while playing a multi-channel audio signal <Video Out>	105
– Charge the iPod/iPhone when this unit is in standby mode <Standby Charge>	104
– Limit access to specific SIRIUS Satellite channels <Parental Lock>	78
– Play music sources on a PC using external controls <DMC Control>	104
– Register your Rhapsody or SIRIUS Internet Radio account <Formal Registration/Trial Registration>	86, 90
■ Customize a scene	
– Register or clear settings for a selected scene <Save>, <Load>, <Reset>	107
– Turn on a Yamaha BD/DVD player or CD player connected to this unit automatically when a scene is selected <SCENE IR>	107
– Changing a scene name and icon <Rename/Icon Select>	108
■ Adjust a sound program (sound program)	
– Adjust sound program parameters	109
■ Display settings information for this unit	
– Display audio signal information <Audio Signal>	132
– Display video signal information <Video Signal>	132
– Display HDMI signal information <HDMI Monitor>	132
– Display network information <Network>	133
– Display system information <System>	133
– Display Zone information <Zone>	133

Continues to the next page



■ Adjust acoustic parameters to match your speakers and listening environment

- Specify speaker acoustic parameters automatically (Yamaha Parametric Room Acoustic Optimizer - YPAO).....43
- Set up this unit's speaker configuration simply <Power Amp Assign>116
- Specify settings for each speaker <Configuration>116
- Control volume control for each speaker <Level>118
- Apply speaker distance settings <Distance>118
- Control equalizer sound quality <Parametric EQ>.....118
- Adjust test tone speaker <Test Tone>119

■ Adjust audio signals output from this unit

- Correct lag between audio and video signals <Lipsync>120
- Select a dynamic range adjustment method <Dynamic Range>120
- Specify the maximum volume <Max Volume>120
- Specify the initial volume <Initial Volume>.....120
- Restrict the video signals during the Pure Direct Mode <Pure Direct Mode>.....120
- Adjust DSP effect and volume level <Adaptive DSP Level>.....121

■ Adjust video signals output from this unit

- Convert analog video signal to another type of signal <Analog to Analog Conversion>121
- Specify the resolution and aspect ratio of video signals and adjust video quality <Processing>.....121

■ HDMI settings

- Assign the audio input source for the TV <TV Audio Input>.....124
- Listen to TV audio with HDMI cable connection <ARC (Audio Return Channel)>.....123
- Transmit HDMI audio/video to the TV during standby mode <Standby Through>124
- Change the output destination of HDMI input audio signals <Audio Output>.....124

■ Network settings

- Specify this unit's IP address <IP Address>.....125
- Accept the commands over a LAN network when this unit is in the standby mode <Network Standby>125
- Specify the mac address filter for this unit <MAC Address Filter>125

■ Enable listening in multiple rooms (multi-zone function)

- Adjust Zone2/Zone3 volume <Zone2 Set/Zone3 Set>126
- Display the Zone2/Zone3/Zone4 menu on the TV <Monitor Out Assign>127
- Rename each zone or scene <Zone2 Scene Rename/Zone3 Scene Rename/Zone4 Scene Rename/Zone Rename>128

■ Specify other functions for this unit

- Enter standby mode automatically when no operations are performed <Auto Power Down>129
- Assign the other input to the selected input source <Input Assignment>129
- Adjust the brightness of the front panel display <Dimmer>130
- Change the wall paper displayed on the TV screen <Wall Paper>.....130
- Specify the function of the TRIGGER OUT jack for controlling external components <Trigger Output1/Trigger Output2>.....130
- Prohibit changes to settings <Memory Guard>.....131

Adjust settings for each input source <Option menu>

- Adjust bass and treble levels <Tone Control>64
- Enable low-volume background music <Adaptive DRC>64
- Enjoying more spatial sound fields <CINEMA DSP 3D Mode>.....64
- Adjust the vertical position of dialogues <Dialogue Lift>64
- Select the 5.1-channel signal playback method <Extended Surround>64
- Adjust the volume of input sources <Volume Trim>.....65
- Selecting a video adjustment preset <Video Adjustment>65
- Selecting audio input jacks <Audio Select>.....65
- Shuffle or repeat the song <Shuffle/Repeat>.....65
- Connect / Disconnect Bluetooth component to this unit <Connect/Disconnect>65
- Pairing Bluetooth component with this unit <Pairing>65



Part names and functions

Front panel

① **MAIN ZONE**  (Power)

Switches this unit between on and standby mode.

② **HDMI Through/iPod Charge indicator**

Lights up in any of the following cases while the unit is in standby mode.

- When the Standby Through function is enabled and audio/video from an external component connected with HDMI is output to a TV during standby mode ([p. 124](#)).
- When an iPod/iPhone, which is placed in the Universal Dock for iPod, is charging while the unit is in standby mode ([p. 104](#)). This indicator also lights up when the Yamaha Wireless System for iPod is connected to this unit ([p. 96](#)).

③ **Front panel display**

Displays information on this unit ([p. 11](#)).

④ **PURE DIRECT**

Switches this unit to Pure Direct Mode ([p. 57](#)).

⑤ **INPUT selector**

Selects an input source from which to playback. Rotate this selector to cycle through the input sources in order.

⑥ **VOLUME**

Adjusts the volume level.

■ Opening and closing the front panel door

To use controls or jacks behind the front panel door, gently press the bottom of the door to open it. Keep the door closed when not using controls or jacks behind the front panel door.

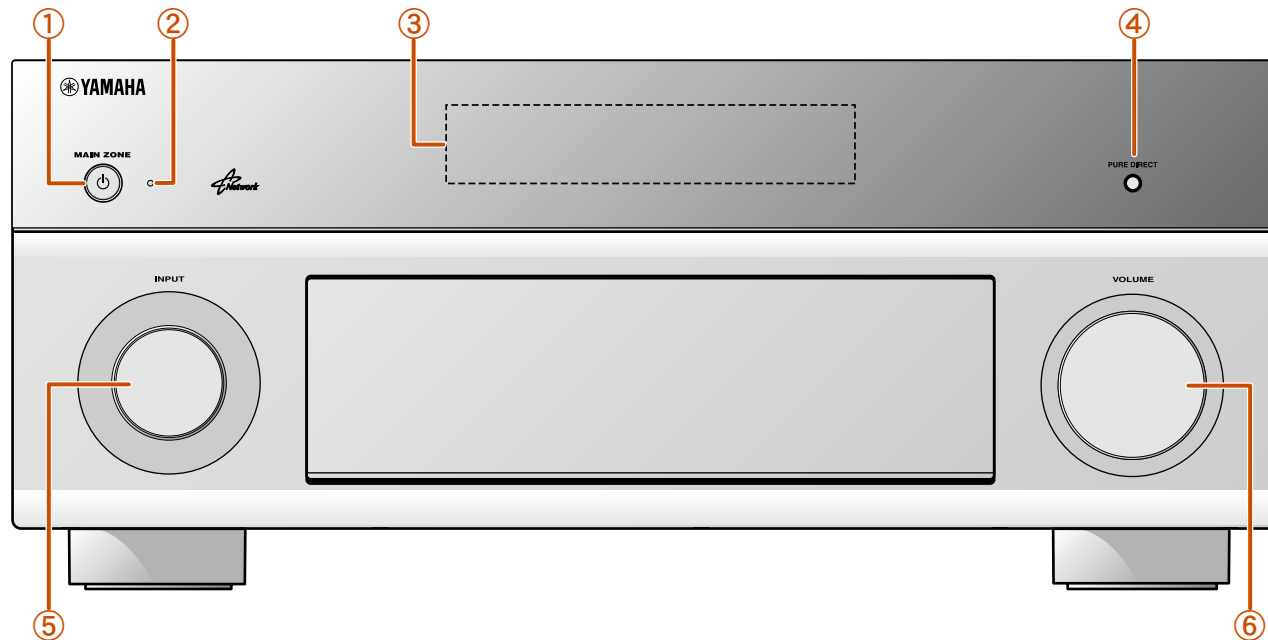
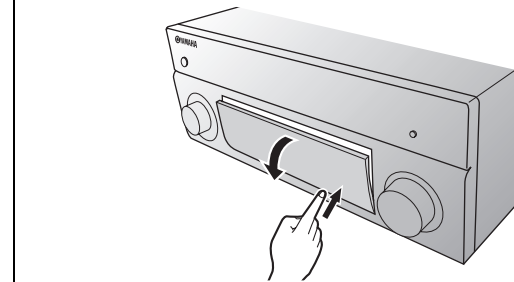

Continues to the next page



Front panel with the cover opened

- ⑦ **ON SCREEN**
Turns on and off the ON SCREEN menu.
- ⑧ **OPTION**
Turns on and off the Option menu ([p. 62](#)).
- ⑨ **TONE/BALANCE**
Adjusts high-frequency/low-frequency output of speakers/headphones in each zone ([p. 53](#), [p. 154](#)).
- ⑩ **STRAIGHT**
Adjusts the balance of the volume of the left and right channels in Zone2, Zone3 or Zone4 ([p. 154](#)).
- ⑪ **PROGRAM** </>
Changes a sound program to straight decoding mode ([p. 56](#)).
- ⑫ **SCENE**
Selects a sound program ([p. 55](#)). Press the left or right key repeatedly to cycle through sound programs.
- ⑬ **SCENE**
Switches the input source, the sound program, and the HDMI OUT with a single button ([p. 54](#), [p. 106](#)). When this unit is in standby mode, press this key to switch on.

- ⑭ **MULTI ZONE**
ZONE2/ZONE3/ZONE4
Switches to enable/disable the audio and video output to Zone2, Zone3 and/or Zone4 ([p. 126](#), [p. 152](#)).
- ⑮ **ZONE CONTROLS**
Switches to Zone2, Zone3 or Zone4 operation mode. This unit, or its remote control, can be used to select input sources or adjust volume for an external amplifier in another room or the built-in amplifier for speakers in another room ([p. 154](#)).
- ⑯ **INFO**
Changes the information displayed on the front panel display ([p. 11](#)).
- ⑰ **MEMORY**
Registers FM/AM stations as preset stations ([p. 67](#)) or SIRIUS channels as preset channels ([p. 76](#)). 🌱1
- ⑱ **FM/AM (CATEGORY </>)**
Sets the FM/AM tuner band to FM or AM ([p. 67](#)). 🌱1
- ⑲ **PRESET </>**
Selects a channel category for a SIRIUS ([p. 76](#)).
- ⑳ **PRESET </>**
Selects an FM/AM preset station ([p. 68](#)) or a SIRIUS preset channel ([p. 77](#)). 🌱1

- ㉑ **Cursor** △ / ▽ / ◀ / ▶, **ENTER, RETURN**
Cursor △ / ▽ / ◀ / ▶ Select menu items and change settings when menus, etc., are displayed.
- ㉒ **ENTER**
RETURN
Confirms a selected item.
- ㉓ **ENTER**
RETURN
Returns to the previous screen when menus are displayed, or close the menu.
- ㉔ **USB port**
For connecting a USB memory device or USB portable audio player ([p. 41](#)).
- ㉕ **DISPLAY**
Switches the display between the Now Playing view and the Browse view.
- ㉖ **YPAO MIC jack**
Connect the supplied YPAO microphone and adjust the speaker balance automatically ([p. 43](#)).
- ㉗ **PHONES jack**
For plugging headphones in. Sound effects applied during playback can also be heard through the headphones.
- ㉘ **VIDEO AUX jacks**
For connecting game consoles to this unit temporarily ([p. 38](#)).
- ㉙ **TUNING/CH** << / >>
Changes FM/AM tuner frequencies ([p. 67](#)) or SIRIUS Satellite Radio channels ([p. 76](#)). 🌱1

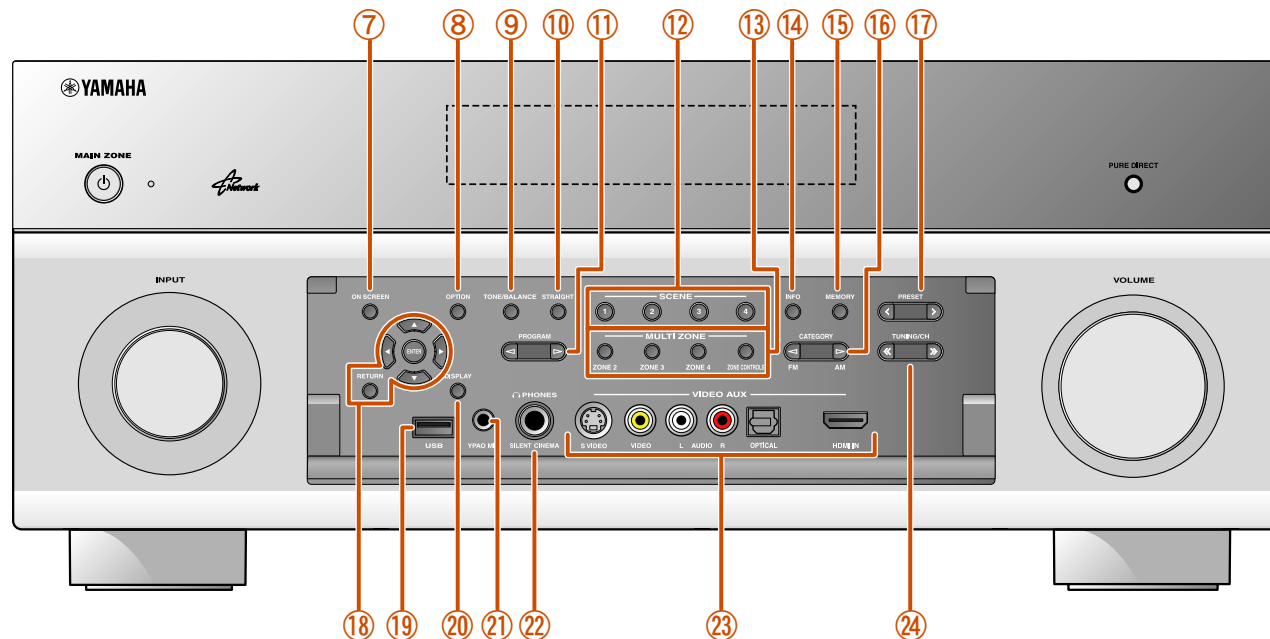

🌱 1 : Usable when you have selected TUNER or SIRIUS input.

Rear panel

① **PHONO jacks**

For connecting a turntable (p. 37).

② **DOCK jack**

For connecting an optional Universal Dock for iPod (such as YDS-12), Wireless System for iPod (YID-W10), or Bluetooth Wireless Audio Receiver (YBA-10) (p. 94, p. 96, p. 98).

③ **NETWORK port**

For connecting to a network (p. 40).

④ **HDMI OUT 1-2 jacks**

For connecting an HDMI-compatible TV to output audio/video signals (p. 31).

⑤ **MON.OUT/ZONE OUT jacks (S-VIDEO/VIDEO jacks)**

For connecting a TV capable of receiving video input, and outputting video signals to it (p. 31, p. 32).

⑥ **COMPONENT VIDEO jacks**

For connecting external components that support component video output for video signal reception (p. 34).

⑦ **HDMI input jacks**

For connecting external components equipped with HDMI-compatible outputs to receive audio/video signals (p. 33).

⑧ **MONITOR OUT/ZONE OUT jacks (COMPONENT VIDEO jacks)**

For connecting TV that are compatible with component video signals, using three cables to output video signal (p. 31).

⑨ **REMOTE IN/OUT1-2 jacks**

For connecting an external component that supports the remote control function (p. 39).

⑩ **TRIGGER OUT 1-2 jack**

For connecting an external component that supports the trigger function to operate it linked with operation of this unit (p. 39).

⑪ **RS-232C terminal**

This is a control expansion terminal for custom installation. Consult your dealer for details.

⑫ **SIRIUS jack**

For connecting a SiriusConnect tuner (sold separately) (p. 74).

⑬ **AV1-4 jacks**

For connecting to external components equipped with audio/video outputs to receive audio/video signals (p. 34).

⑭ **ANTENNA jacks**

For connecting AM and FM antennas (p. 42).

⑮ **AV OUT jacks**

For outputting audio/video signals received when analog inputs are selected (p. 40).

⑯ **AUDIO1-4 jacks**

For connecting external components equipped with audio outputs to receive audio signals (p. 37).

⑰ **MULTI CH INPUT jacks**

For connecting a player that supports a multi-channel output (p. 38).

⑱ **ZONE OUT jacks**

Outputs sound of this unit to an external amplifier set in a different room. (p. 152).

⑲ **PRE OUT terminals**

For connecting a subwoofer with built-in amplifier or an external power amplifier (p. 23, p. 28).

⑳ **SPEAKERS terminals**

For connecting the front, center, surround and surround back speakers (p. 20). Connect the front/rear presence speakers (p. 20) or the speakers for Zone2 and Zone3 (p. 21) to the EXTRA SP jacks.

㉑ **AC IN**

For connecting the supplied power cable.

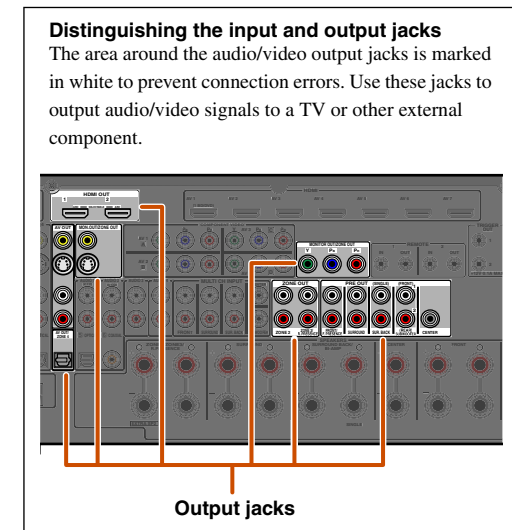
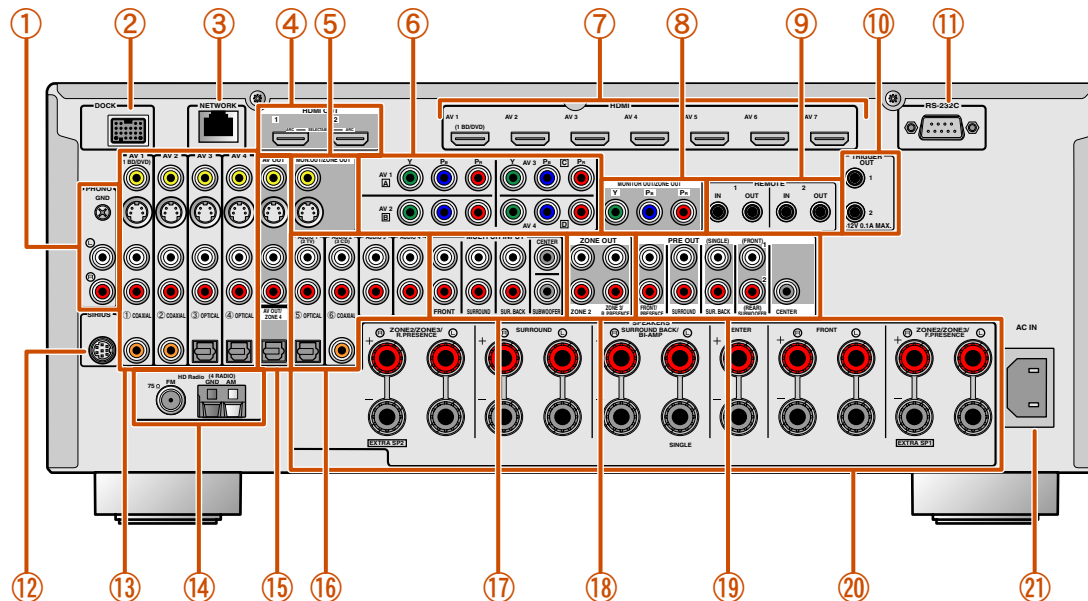

Front panel display

- ① **Tuner indicator**
Lights up according to the status of a received station (p. 67).
- ② **HD indicator**
Lights up when this unit is tuned into the HD Radio station (p. 70).
- ③ **TAG indicator**
Lights up when the selected HD Radio program (or song being played) supports iTunes Tagging (p. 71).
- ④ **ZONE2/ZONE3/ZONE4 indicator**
Lights up when the audio or video output to Zone2, Zone3 or Zone4 is enabled (p. 154).
- ⑤ **SLEEP indicator**
Blinks when the sleep timer is on (p. 13, p. 154).
- ⑥ **PARTY indicator**
Lights up when the party mode is active (p. 127).
- ⑦ **Multi information display**
Displays a range of information on menu items and settings.
- ⑧ **VOLUME indicator**
Displays the current volume level.
- ⑨ **HDMI indicator**
Lights up during normal HDMI communication.
- IN indicator**
Lights up when this unit detects the external component connected to the HDMI input jack (p. 33).
- OUT 1/OUT 2 indicators**
Indicate which HDMI OUT jack outputs audio/video signals (p. 31).

- ⑩ **ENHANCER indicator**
Lights up when the Compressed Music Enhancer is active (p. 57).
- ⑪ **CINEMA DSP indicator**
Lights up when a sound field effect that uses CINEMA DSP technology is selected.
- ⑫ **CINEMA DSP 3D indicator**
Lights up when CINEMA DSP 3D is activated (p. 56).
- ⑬ **Cursor indicators**
Light up if corresponding cursors on the remote control are available for operations.
- ⑭ **MUTE indicator**
Blinks when audio is muted.
- ⑮ **Speaker indicators**
Indicate speaker terminals from which signals are output.

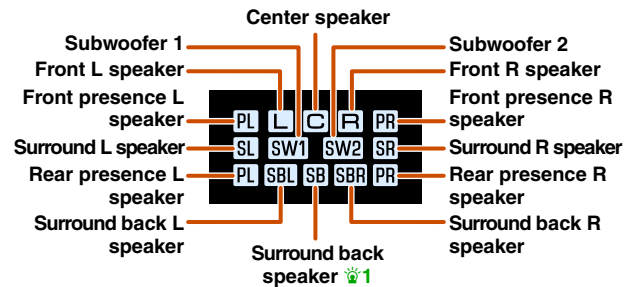

- ⑯ **ADAPTIVE DRC indicator**
Lights when the adaptive dynamic range control feature is tuned on (p. 64).

Switching information on the front panel display

The front panel can display sound programs and surround decoder names as well as the active input source.

Press **INFO** repeatedly to cycle through displayed informations. 2

Input source name

Sound program (DSP program)

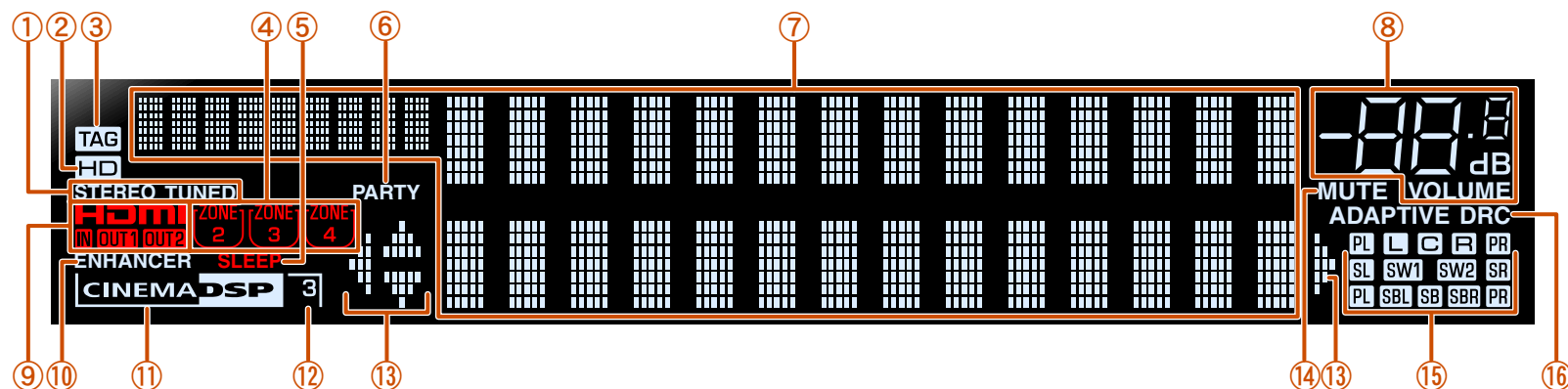

1: "SB" is displayed when using a 6.1-channel configuration only.

2: During FM/AM reception, the frequency is displayed instead of the input source. During SIRIUS Satellite Radio signals reception, the channel is displayed instead of the input source.

Remote control

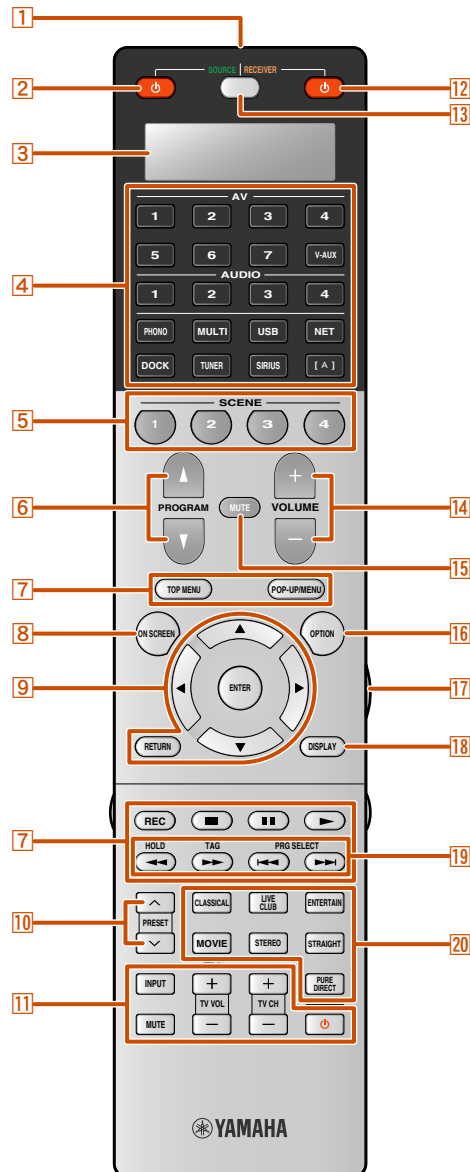

- 1 Remote control signal transmitter**
Transmits infrared signals.
- 2 SOURCE \square (SOURCE Power)**
Switches an external component on and off.
- 3 Display window**
Displays remote control information.
- 4 Input selector**
Select an input source on this unit from which to playback.

AV1-7	AV1-7 jacks
V-AUX	Front panel VIDEO AUX jacks
AUDIO1-4	AUDIO1-4 jacks
PHONO	PHONO jacks
MULTI	MULTI CH INPUT jacks
USB	A USB storage device connected to the USB port.
NET	Rhapsody service, sirius internet radio, internet radio, a USB connected to the USB port, or a PC connected to the NETWORK port.
- DOCK**
A Universal Dock for iPod, Wireless System for iPod, or Bluetooth Wireless Audio Receiver connected to the DOCK jack.
- TUNER**
FM/AM tuner
- SIRIUS**
A SIRIUS Satellite Radio tuner connected to the SIRIUS jack.
- [A]**
Changes the external component to operate with the **7 External component operation keys** without changing inputs. 1
- 5 SCENE**
Switch the input source and the sound program with a single button ([p. 54](#)). When this unit is in standby mode, press this key to switch on.
- 6 PROGRAM Δ / ∇**
Selects a sound program ([p. 55](#)). Press the up or down key repeatedly to cycle through sound programs.
- 7 External component operation keys**
Operate recording, playback, and menu displays etc. for external components ([p. 134](#)). 1
- 8 ON SCREEN**
Turns on and off the ON SCREEN menu.
- 9 Cursor $\Delta / \nabla / \triangleleft / \triangleright$, ENTER, RETURN**

Cursor $\Delta / \nabla / \triangleleft / \triangleright$	Select menu items and change settings when menus, etc., are displayed.
ENTER	Confirms a selected item.
RETURN	Returns to the previous screen when menus are displayed, or close the menu.
- 10 PRESET \wedge / \vee**
Selects a preset station when the FM/AM or SIRIUS Satellite Radio tuner is operated.
- 11 TV control keys**
Operate a monitor such as a TV.
- 12 RECEIVER \square (RECEIVER Power)**
Switches this unit between on and standby mode.
- 13 SOURCE/RECEIVER**
Switches remote control key function to operate this unit or an external component ([p. 134](#)). Operate an external component when this key glows green, or this unit when this key glows orange.
- 14 VOLUME +/-**
Adjust the volume level ([p. 52](#)).
- 15 MUTE**
Turns the mute function of the sound output on and off ([p. 52](#)).
- 16 OPTION**
Turns on and off the Option menu ([p. 62](#)).
- 17 LIGHT**
Lights up the silicon buttons while pressing this key.
- 18 DISPLAY**
Switches the display between the Now Playing view and the Browse view.
- 19 HD Radio/SIRIUS Satellite Radio keys**

HOLD	Remains the current artist name and song title displayed (p. 72 , p. 78).
TAG	Stores "tag" data to the iPod or internal memory of this unit (p. 71).
PRG SELECT	Selects an HD Radio audio program (p. 70).
- 20 Sound selection keys**
Switch between the current sound field effect (sound program) and the surround decoder ([p. 55](#)).

1 : You can use **7 External component operation keys** for each input source to operate registered components. Remote control codes must be registered for each input in advance if you want to operate external components ([p. 136](#)).

Remote control with the cover opened

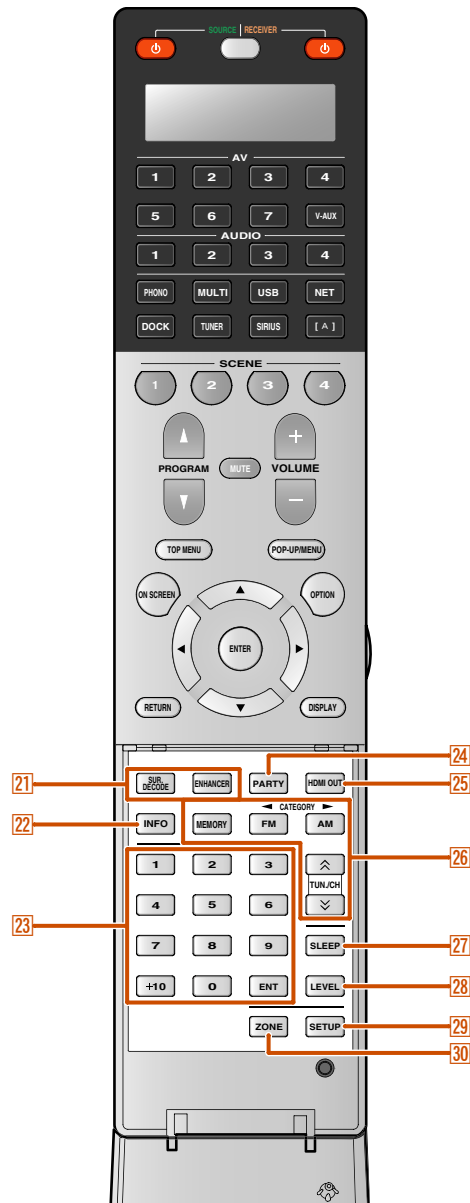

- 21 Sound selection keys**
Switch between the current sound field effect (sound program) and the surround decoder ([p. 55](#)).
- 22 INFO**
Cycles the information displayed on the front panel display (the name of the currently selected input source, the sound program, the surround decoder, the FM/AM tuner frequency, etc.).
- 23 Numeric keys**
Enter numbers.
- 24 PARTY**
Switches the party mode on and off ([p. 155](#)).
- 25 HDMI OUT**
Switches the output jack connected to an HDMI compatible TV ([p. 52](#)).
- 26 Radio control keys**
Operates the FM/AM or SIRIUS Satellite Radio tuner. These keys are used when using the tuner input.
MEMORY Presets radio stations.
FM Sets the FM/AM tuner band to FM.
AM Sets the FM/AM tuner band to AM.
(CATEGORY </>) Selects a category of the SIRIUS Satellite Radio channel.
TUN./CH \wedge / \vee Changes tuning frequencies or SIRIUS Satellite Radio channels.
- 27 SLEEP**
Switches this unit to standby mode automatically after a specified period of time has elapsed (sleep timer). Press this key repeatedly to set the time for the sleep timer function.

The SLEEP indicator lights up when the sleep timer is on.
- 28 LEVEL**
Adjusts the output level for each speaker ([p. 118](#)).
- 29 SETUP**
Setup this remote control ([p. 135](#)).
- 30 ZONE**
Switches the zone to be operated by the remote control between the Main zone, Zone2, Zone3 and Zone4 ([p. 154](#)).

■ Installing batteries in the remote control

When inserting batteries in the remote control, remove the battery compartment cover from the reverse side of the remote control, and insert four AAA batteries into the battery compartment so that they match with the polarity markings (+ and -).

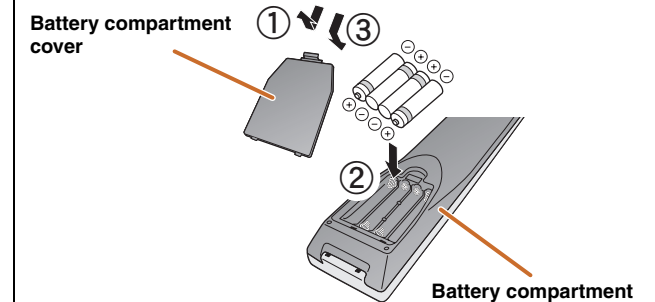

Replace the batteries with new ones if the remote control can only be operated within a narrow range.

NOTE

If there are remote control codes for external components registered to the remote control, removing the batteries for more than 2 minutes, or leaving exhausted batteries in the remote control, may clear the remote control codes. If this should occur, replace the batteries with new ones, and set the remote control codes.

On-screen display

When a TV is connected to this unit, the supplied remote control can be used to specify and verify this unit's settings via menus and options displayed on the TV screen.

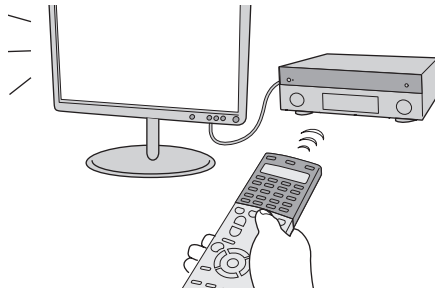

The following displays are available in the on-screen display.

ON SCREEN menu

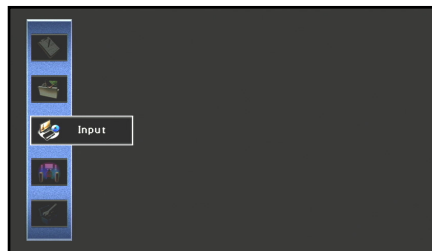

Press **[8] ON SCREEN** to display the ON SCREEN menu.

Detailed settings for this unit can be configured. Use this menu to select desired settings, change their values, or check the current status of this unit.

Refer to "SETUP" ([p. 102](#)) for details.

Option menu

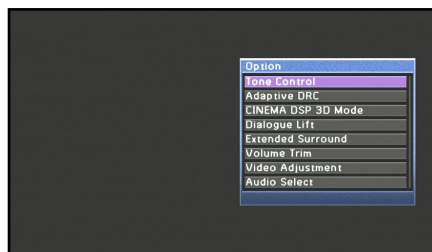

Press **[16] OPTION** to display the Option menu.

Configure the optional settings for each input source. Settings such as "Tone Control" and "Volume Trim" are applied to this unit regardless of the input source.

Refer to "Configuring settings specific to an individual input source (Option menu)" ([p. 62](#)) for details.

Content window



Press **[4] Input selector** to display the content window.

Includes the Browse view and the Now Playing view. The Now Playing view displays the status of the source from which music is currently played back. Adjust settings for music content from the Browse view.

Refer to "Confirming and operating input sources from the content window" ([p. 66](#)) for details.

CONNECTIONS

Connecting speakers

This unit uses acoustic field effects and sound decoders to bring you the impact of a real movie theater or concert hall. These effects will be brought to you with ideal speaker positioning and connections in your listening environment.

Speaker channels and functions

Front left and right speakers

The front speakers are used for the front channel sounds (stereo sound) and effect sounds.

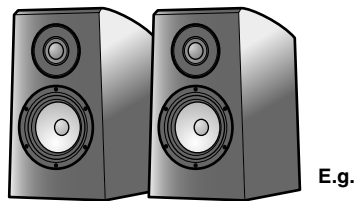

Front speaker layout:

Place these speakers at an equal distance from the ideal listening position in the front of the room. When using a projector screen, the appropriate top positions of the speakers are about 1/4 of the screen from the bottom.

Center speaker

The center speaker is for the center channel sounds (dialog, vocals, etc.).



Center speaker layout:

Place it halfway between the left and right front speakers. When using a TV, place the speaker just above or just under the center of the TV with the front surfaces of the TV and the speaker aligned. When using a screen, place it just under the center of the screen.

Surround left and right speakers

The surround speakers are for effect and vocal sounds while playing back more than 5.1-channel source. When used with no surround back speaker while playing back more than 6.1-channel source (including surround back channel), sound of surround back channel is distributed between the left and right surround speakers.

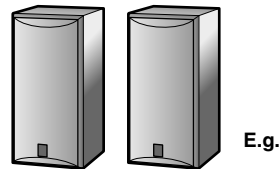

Surround speaker layout:

Place the speakers at the rear of the room on the left and right sides facing the listening position. They should be placed between 60 degrees and 80 degrees from the listening position and with the speaker tops at a height of 4.9 – 5.9 ft. (1.5 – 1.8 m) from the floor.

Presence left and right speakers

The front and rear presence speakers are used for front and rear effect sounds. When used in combination with the sound programs ([p. 58](#)), a sound with a richer and more spatial presence is possible.

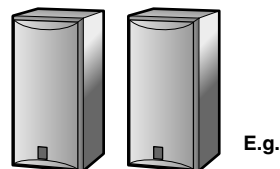

Presence speaker layout:

Place the left and right front presence speakers 1.6 – 3.3 ft. (0.5 – 1 m) to the outside of the left and right front speakers respectively. The tops of the both front and rear presence speakers should be 5.9 ft. (1.8 m) above the floor.

Surround back left and right speakers

The surround back speakers are for rear effect sounds while playing back more than 6.1-channel source. When used with only one surround back speaker while playing back more than 7.1-channel source, sound of the left and right surround back channel is mixed and output from a single speaker.

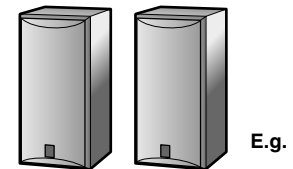

Surround back speaker layout:

When used with 7.1ch sound, arrange the left and right speakers towards the listening position, to the rear of the listening position. Arrange the left and right speakers at least 1 ft. (30 cm) apart. The same separation as with the front left and right speakers is optimum.

When used with 6.1ch sound, arrange these to the rear of the listening position.

Subwoofer

The subwoofer speaker is used for bass sounds and low-frequency effect (LFE) sounds included in Dolby Digital and DTS. Use a subwoofer that is equipped with built-in amplifier.



Subwoofer speaker layout:

Place it to the outside of the front left and right speakers facing slightly inward to reduce echoes from the wall. You can use one or two subwoofers and select the position of subwoofers from “Left + Right,” “Front + Rear” and “Monaural x2” ([p. 117](#)).



Speaker layout

In addition to the 7.1-channel speaker layout, a variety of speaker configurations can be specified with presence speaker connection, bi-amp connection or the Zone2/Zone3 function.

In addition, this unit is equipped with the “Power Amp Assign” function, which can be used to easily apply the appropriate speaker settings to this unit according to speaker configuration.

Connection of speakers

Connect the speakers to the appropriate jacks shown in the table for each speaker layout. Refer to “Connecting speakers and subwoofers” (p. 20) for details on connecting speakers.

You can also use two subwoofers by connecting them to both SUBWOOFER1 (FRONT) and SUBWOOFER2 (REAR) jacks. And, you can use the EXTRA SP1 jacks for Zone3 speakers and EXTRA SP2 jacks for Zone2 by setting the assignment with “Power Amp Assign” (p. 116).

Assigning a speaker configuration

A speaker configuration must be assigned to this unit to activate the speakers. Use the Power Amp Assign function to apply the appropriate settings shown in the table for each speaker layout. Refer to “Power Amp Assign” (p. 116) for details on setting.

Enjoying the 7.1 channel audio source

7.1-channel speaker layout (7 speakers + subwoofer)

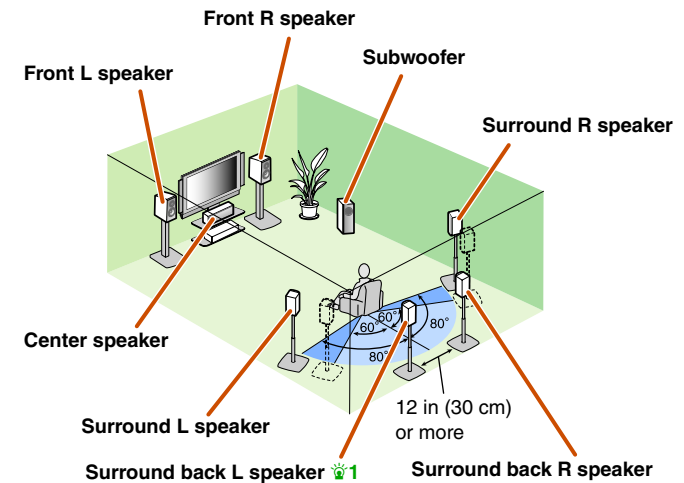

Audio from a 7.1-channel audio source can be played back with no degradation with this speaker configuration.

Connections of speakers

FRONT jacks	Front L/R speakers	SURROUND BACK jacks	Surround back L/R speakers
CENTER jack	Center speaker	SUBWOOFER (PRE OUT) jack	Subwoofer
SURROUND jacks	Surround L/R speakers		

Assigning a speaker configuration

Power Amp Assign	7ch Normal (Default)
-------------------------	----------------------

1: The sound of surround back channel can also be output from a single surround back speaker. When only one surround back speaker is used, connect it to the SURROUND BACK L (SINGLE) jack and place it directly behind the listening position.

■ Adding the front presence speakers for a richer sound field effect

■ Presence speaker layout (7 speakers + subwoofer + front presence speakers)

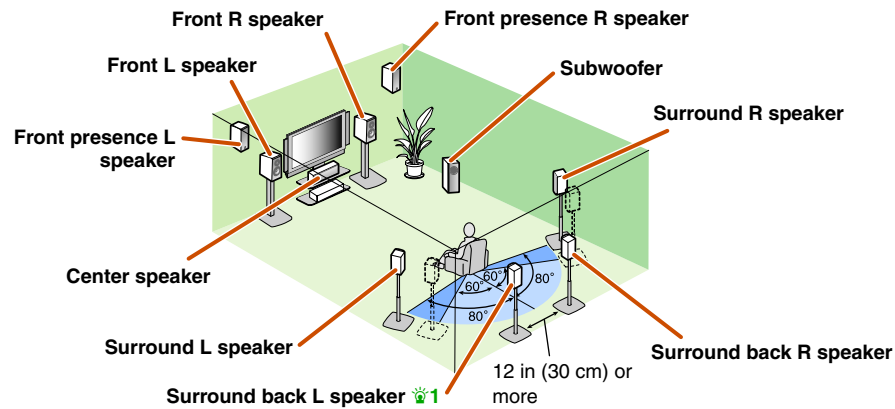

■ Enjoying the audio source without surround back speakers

■ 5.1-channel speaker layout (5 speakers + subwoofer)

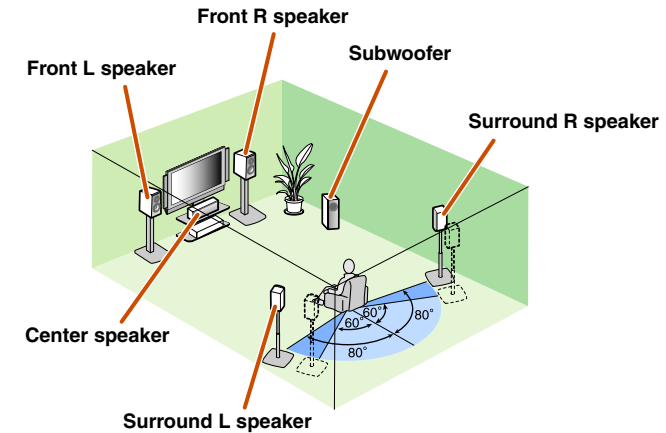

This unit automatically selects the front presence or surround back speakers to output sounds according to the selected sound program.
When the sound program is changed, the speakers that output the sound are switched between the front presence speakers and surround back speakers automatically. 🌟2

This unit can mix 7.1-channel audio source down to 5.1-channel sound. This enables 7.1-channel sound without surround back speakers.

■ Connections of speakers

FRONT jacks	Front L/R speakers	SURROUND BACK jacks	Surround back L/R speakers
CENTER jack	Center speaker	SUBWOOFER (PRE OUT) jack	Subwoofer
SURROUND jacks	Surround L/R speakers	EXTRA SP1 jacks	Front presence L/R speakers

■ Connections of speakers

FRONT jacks	Front L/R speakers	SURROUND jacks	Surround L/R speakers
CENTER jack	Center speaker	SUBWOOFER (PRE OUT) jack	Subwoofer

■ Assigning a speaker configuration

Power Amp Assign	7ch Normal (Default)
------------------	----------------------

■ Assigning a speaker configuration

Power Amp Assign	7ch Normal (Default)
------------------	----------------------

🌟1: The sound of surround back channel can also be output from a single surround back speaker. When only one surround back speaker is used, connect it to the SURROUND BACK L (SINGLE) jack and place it directly behind the listening position.

🌟2: Sound cannot be output from the surround back speakers when it is output from the speakers connected to the EXTRA SP1 jacks.

Using the front speakers that support bi-amp connections for a high quality sound

5.1-channel speaker layout (Front speakers (Bi-amp) + 3 speakers)

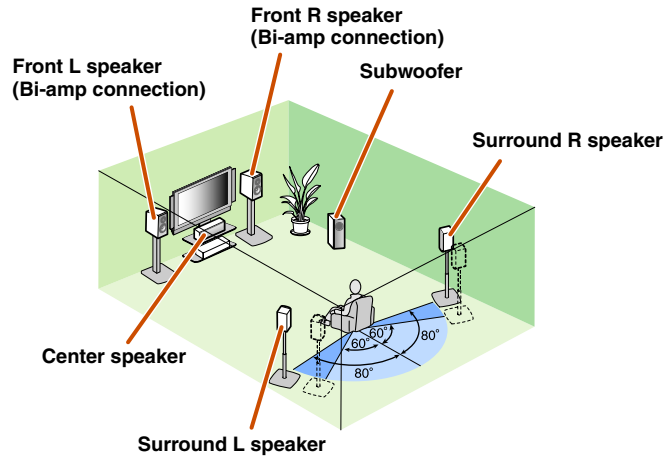

Using the front speakers that support bi-amp connections reproduces a high quality sound.

Connections of speakers

FRONT jacks	Front L/R speakers (bi-amp)	SURROUND BACK jacks	Front L/R speakers (bi-amp)
CENTER jack	Center speaker	SUBWOOFER (PRE OUT) jack	Subwoofer
SURROUND jacks	Surround L/R speakers		

Assigning a speaker configuration

Power Amp Assign	5ch BI-AMP
-------------------------	------------

- 💡 1: The sound of surround back channel can also be output from a single surround back speaker. When only one surround back speaker is used, connect it to the SURROUND BACK L (SINGLE) jack and place it directly behind the listening position.
- 💡 2: Sound cannot be output from the surround back speakers when it is output from the speakers connected to the EXTRA SP1 jacks.
- 💡 3: EXTRA SP1 jacks can also be assigned to the Zone3 speakers with "Power Amp Assign" (p. 116).

Using speakers in two rooms (Zone2 function)

7.1-channel speaker layout + Zone2 (7 speakers (in main zone) + subwoofer (in main zone) + front speakers (in secondary zone))

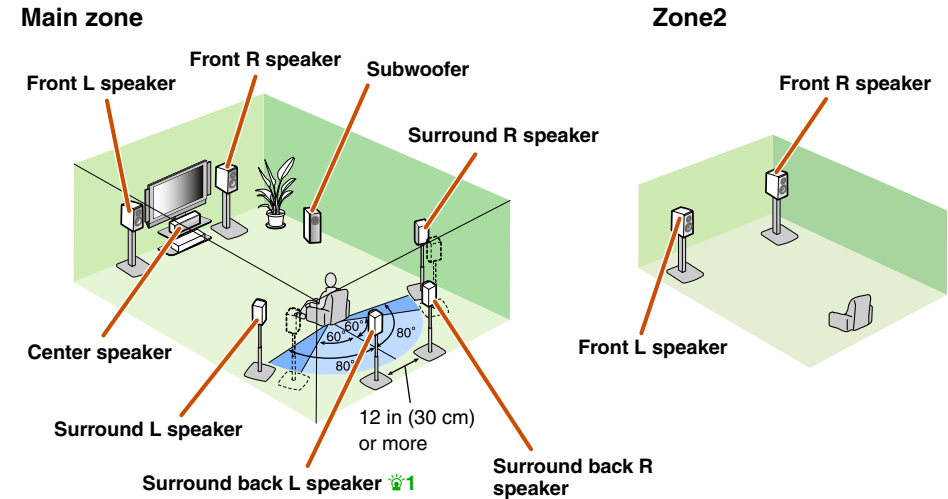

In addition to the main room, speakers in another room can also be controlled. When the built-in amplifier assigned to speakers in another room is turned on, sound output automatically switches from the surround back speakers to the speakers in the other room. 💡 2

Connections of speakers

FRONT jacks	Front L/R speakers	SURROUND BACK jacks	Surround back L/R speakers
CENTER jack	Center speaker	SUBWOOFER (PRE OUT) jack	Subwoofer
SURROUND jacks	Surround L/R speakers	EXTRA SP1 jacks 💡 3	Zone2 speakers

Assigning a speaker configuration

Power Amp Assign	7ch + 1ZONE
-------------------------	-------------

Using speakers in three rooms (Zone2 and Zone3 functions)

7.1-channel speaker layout + Zone2 + Zone3 (7 speakers (in main zone) + subwoofer (in main zone) + front speakers (in secondary and tertiary zones))

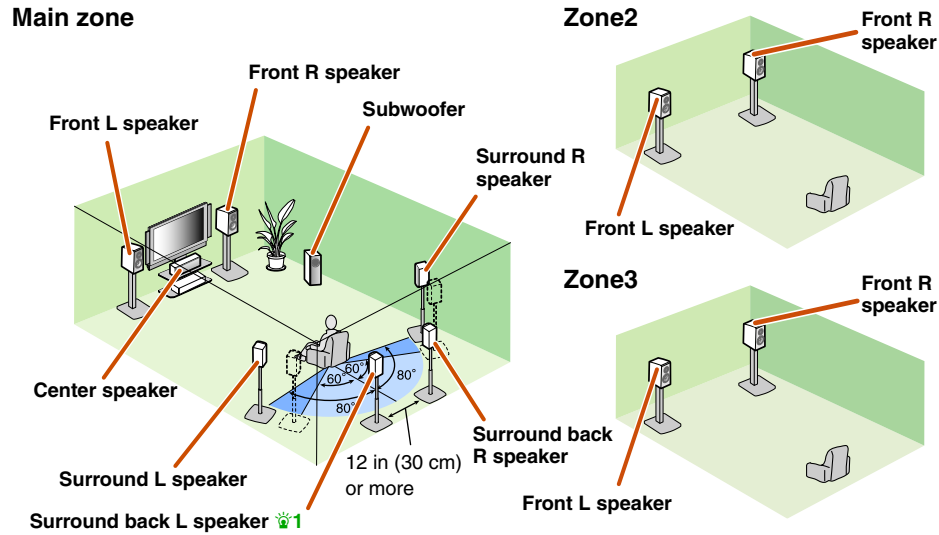

Connections of speakers

FRONT jacks	Front L/R speakers	SUBWOOFER (PRE OUT) jack	Subwoofer
CENTER jack	Center speaker	EXTRA SP1 jacks	Zone2 speakers
SURROUND jacks	Surround L/R speakers	EXTRA SP2 jacks	Zone3 speakers
SURROUND BACK jacks	Surround back L/R speakers		

Assigning a speaker configuration

Power Amp Assign	7ch + 2ZONE
------------------	-------------

In addition to the main room, speakers in other two rooms can also be controlled. When the built-in amplifier assigned to speakers in another room is turned on, sound output automatically switches from the surround back and/or surround speakers to the speakers in the other rooms. ,

- 1**: The sound of surround back channel can also be output from a single surround back speaker. When only one surround back speaker is used, connect it to the SURROUND BACK L (SINGLE) jack and place it directly behind the listening position.
- 2**: Sound cannot be output from the surround back speakers when it is output from the speakers connected to the EXTRA SP1 jacks.
- 3**: Sound cannot be output from the surround speakers when it is output from the speakers connected to the EXTRA SP2 jacks.

- 4**: EXTRA SP1 jacks can also be assigned to the Zone3 speakers with "Power Amp Assign" ([exp. 116](#)).
- 5**: EXTRA SP2 jacks can also be assigned to the Zone2 speakers with "Power Amp Assign" ([exp. 116](#)).

Connecting speakers and subwoofers

Connect your speakers to their respective terminals on the rear panel.

CAUTION

- Remove the power cable of this unit from the power outlet before connecting the speakers.
- Generally speaker cables consist of two parallel insulated cables. One of these cables is a different color, or has a line running along it, to indicate different polarity. Insert the different colored (or lined) cable into the “+” (positive, red) terminal on this unit and the speakers, and the other cable into the “-” (negative, black) terminal.
- Be careful that the core of the speaker cable does not touch anything or come into contact with the metal areas of this unit. This may damage this unit or the speakers. If the speaker cables short circuit, “CHECK SP WIRES!” will appear on the front panel display when this unit is switched on.

■ Front/Center/Surround/Surround back speaker and Subwoofer connection

When connecting only one surround back speaker, connect the speaker to the SURROUND BACK L (SINGLE) jacks.

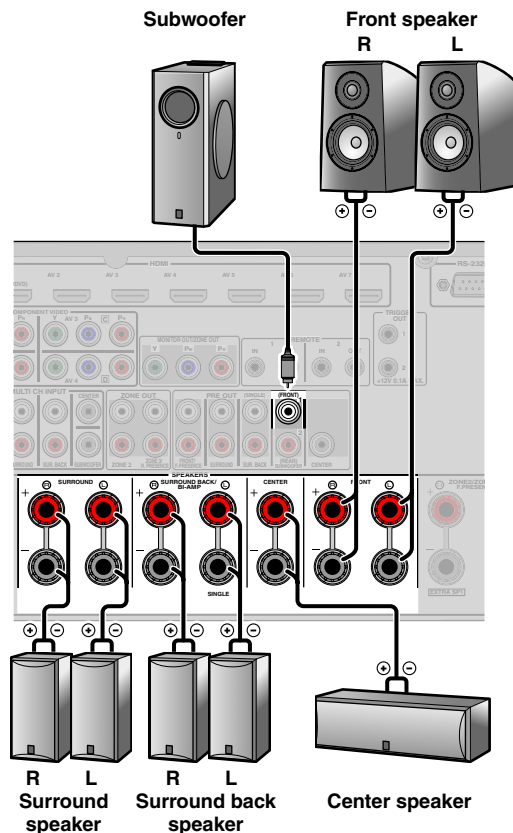

■ Front/rear presence speaker connection

When using the front presence speakers, connect the front presence speakers to EXTRA SP1 jacks. When using the rear presence speakers, connect the rear presence speakers to EXTRA SP2 jacks.

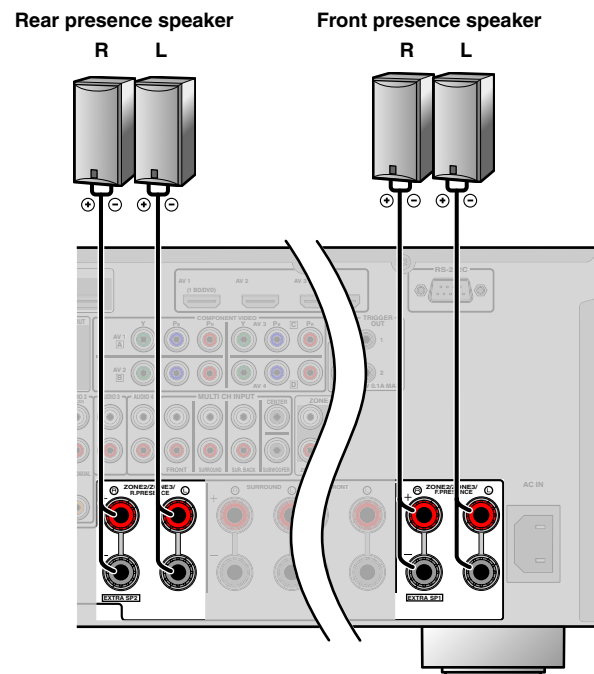

The presence speakers supplement the sound from the front and surround back speakers with extra ambient effects produced by the sound field programs ([p. 58](#)). You can adjust the vertical position of dialogues with using the front presence speakers ([p. 62](#)).

Front presence speakers

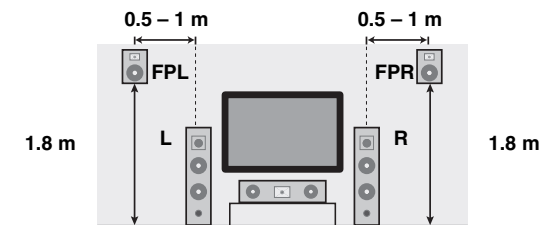

Rear presence speakers

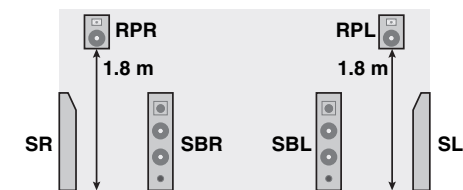

- Connection of presence speakers is recommended to take full advantage of the effects of CINEMA DSP sound programs.
- Place the rear presence left and right speakers so that the distance between the rear presence left and right speakers is same as the distance between front presence left and right speakers.

■ Bi-amp connection

This unit can be connected to speakers that support bi-amp connections. When connecting speakers, connect the FRONT jacks and the SURROUND BACK/BI-AMP jacks as in the diagram below. Configure the bi-amp settings to activate connections.

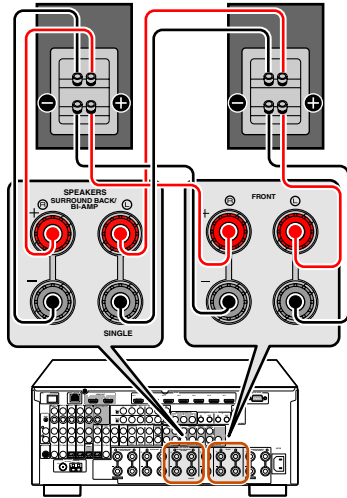

NOTE

Before making bi-amplification connections, remove any brackets or cables that connect a woofer with a tweeter. Refer to the instruction manuals of speakers for details. When not making bi-amplification connections, make sure that the brackets or cables are connected before connecting the speaker cables.

■ Multi-zone audio system using the internal amplifier of this unit

Connect the speakers in the second zone and the third zone to the EXTRA SP1/EXTRA SP2 jacks as in the diagram below.

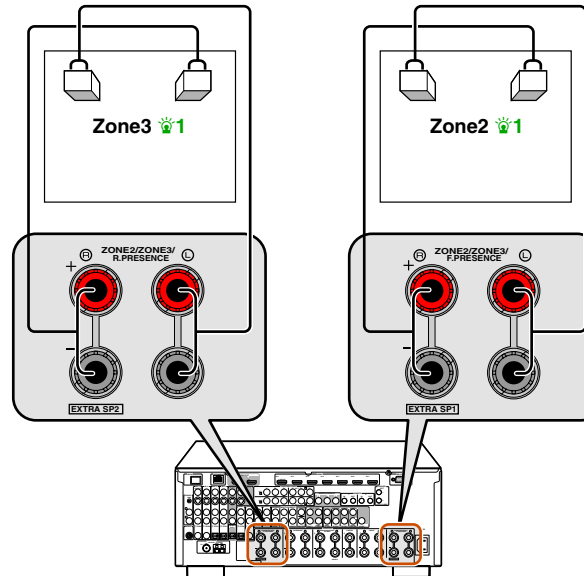

CAUTION

The EXTRA SP jacks of this unit should not be connected to a Passive Loudspeaker Selector Box or more than one loudspeaker per channel. Connection to a Passive Loudspeaker Selector Box or multiple speakers per channel could create an abnormally low impedance load resulting in amplifier damage. See this owner's manual for correct usage. Compliance with minimum speaker impedance information for all channels must be maintained at all times. This information is found on the back panel of this unit.

■ Changing speaker impedance

This unit is configured for 8 Ω speakers at factory setting. When connecting to 6 Ω speakers, carry out the following procedure to switch to 6 Ω. When this unit is configured for 6 Ω speakers, 4 Ω speakers can also be used as the front speakers.

- 1 Switch this unit to the standby mode.
- 2 Press **MAIN ZONE** while pressing and holding **STRAIGHT** on the front panel.

Release the keys when "ADVANCED SETUP" is displayed on the front panel display.

After approximately a few seconds, the top menu item is displayed.

MAIN ZONE

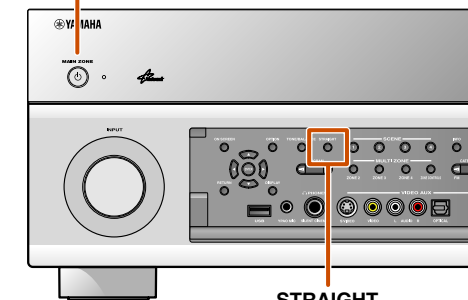

Continues to the next page

- 1: EXTRA SP1 jacks can be assigned to Zone3 and EXTRA SP2 jacks can be assigned to Zone2 by using "Power Amp Assign" ([p. 116](#)).
- 2: Refer to the "Extended functionality that can be configured as needed (Advanced Setup menu)" ([p. 144](#)) for details on the Advanced Setup menu.

- 3** Check that “SPEAKER IMP.” is displayed on the front panel.



- 4** Press STRAIGHT repeatedly to select a “6ΩMIN.”

- 5** Switch this unit to the standby mode, and then switch it on again.

The power turns on, when the settings you made has been configured.

Connecting speakers

This type of jack can connect to the following speakers or connection.

- Front L/R speakers
- Center speaker
- Surround L/R speakers
- Surround back L/R speakers
- Front presence L/R speakers
- Rear presence L/R speakers
- Zone2/Zone3 speakers
- Bi-amp connection (Front L/R speakers)

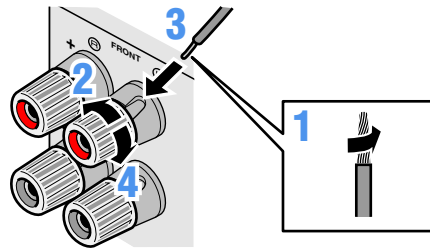

- 1** Remove approximately 0.4 in. (10 mm) of insulation from the ends of the speaker cables, and twist the bare wires of the cables together firmly so that they will not cause short circuits.

- 2** Loosen the speaker terminals.

- 3** Insert the bare wire of the speaker cable into the gap on the side of the terminal.

- 4** Tighten the terminal.

Connecting the banana plug

Tighten the knob, and then insert the banana plug into the end of the terminal.

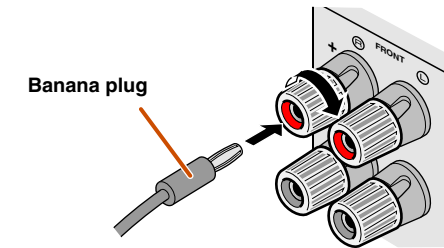

■ Connecting the subwoofers

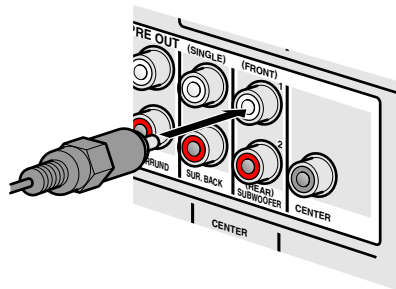

1 Connect the subwoofer input jack to the **SUBWOOFER 1** and/or **2** jack on this unit with an audio pin cable. 💡1

2 Set the subwoofer volume as follows.

Volume: Set to approximately half volume (or slightly less than half).

Crossover frequency (if available): Set to maximum.

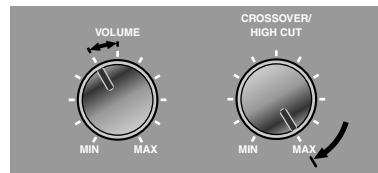

Subwoofer examples

NOTE

After connection, applying this setting to this unit is required to activate all speaker connections. With using “Power Amp Assign” function, you can easily apply the speaker configuration.

Refer to “Power Amp Assign” ([p. 116](#)) for details on using “Power Amp Assign” function.

💡 1: When using the only one subwoofer, connect the subwoofer to the SUBWOOFER1 jack.

Advanced speaker configuration

Speaker layout utilizing an external power amplifier

More speakers can be used by connecting an external amplifier to this unit's PRE OUT jacks. The speaker layout specified using the Power Amp Assign function varies when an external amplifier is connected.

Symbols on the table

L	Front L speaker	FPL	Front presence L speaker
C	Center speaker	FPR	Front presence R speaker
R	Front R speaker	RPL	Rear presence L speaker
SL	Surround L speaker	RPR	Rear presence R speaker
SR	Surround R speaker		Speakers that output sound
SBL	Surround back L speaker		Speakers that output sound depending upon settings
SBR	Surround back R speaker	EA	External amplifier

Connections of speakers

Connect the speakers to the following jacks according to the speaker layout. Refer to “Front/Center/Surround/Surround back speaker and Subwoofer connection” and “Front/rear presence speaker connection” for details on connecting speakers ([p. 20](#)). Refer “Connecting an external amplifier” for details on connecting an external amplifier ([p. 28](#)).

Assigning a speaker configuration

A speaker configuration must be assigned to this unit to activate speakers and an external amplifier. Use the “Power Amp Assign” function to easily apply the appropriate speaker settings to this unit in accordance with speaker configuration.

1: Sound cannot be output from the surround back speakers when it is output from the speakers connected to the EXTRA SP2 jacks.

2: You can also use two subwoofers by connecting them to both SUBWOOFER1 (FRONT) and SUBWOOFER2 (REAR) jacks.

Improving sound quality of front speaker by more high quality Hi-Fi amplifier

9.1-channel speaker layout (7 speakers + subwoofer + external front speakers)

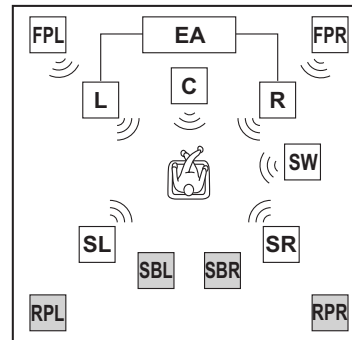

This unit automatically selects the rear presence speakers or surround back speakers to output sounds according to the selected sound program. **1**
The front speaker channel can be enhanced by using an external amplifier possible of greater output power than this unit.

Connections of speakers

CENTER jack	Center speaker
SURROUND jacks	Surround L/R speakers
SURROUND BACK jacks	Surround back L/R speakers
FRONT (PRE OUT) jacks	External amplifier (for front L/R speakers)
SUBWOOFER (PRE OUT) jack 	Subwoofer
EXTRA SP1 jacks	Front presence L/R speakers
EXTRA SP2 jacks	Rear presence L/R speakers

Assigning a speaker configuration

Power Amp Assign	7ch + FRONT
-------------------------	-------------

Using an external amplifier to output the front presence speaker channel

9.1-channel speaker layout (7 speakers + subwoofer + external front presence speakers)

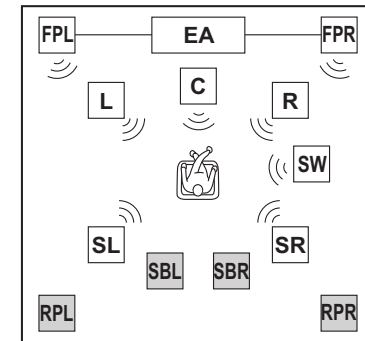

This unit automatically selects the rear presence speakers or surround back speakers to output sounds according to the selected sound program. **1**
The front presence and surround back speaker channels can be output at the same time.

Connections of speakers

FRONT jacks	Front L/R speakers
CENTER jack	Center speaker
SURROUND jacks	Surround L/R speakers
SURROUND BACK jacks	Surround back L/R speakers
F.PRESENCE (PRE OUT) jacks	External amplifier (for front presence L/R speakers)
SUBWOOFER (PRE OUT) jack 	Subwoofer
EXTRA SP2 jacks	Rear presence L/R speakers

Assigning a speaker configuration

Power Amp Assign	7ch + FPR
-------------------------	-----------

Using the presence speakers in the main room and speakers in another room

9.1-channel speaker layout

(7 speakers + subwoofer + external front presence speakers + front speakers (in secondary zone))

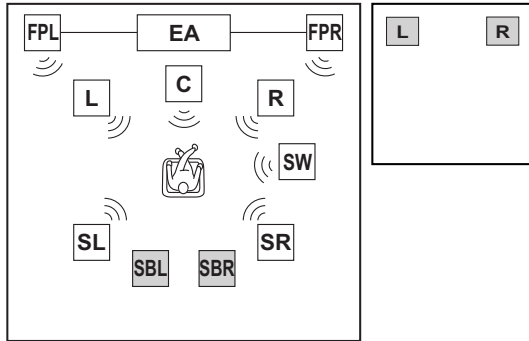

The presence speakers in the main room can be used while the front speakers in another room are used. 🌱1

Connections of speakers

FRONT jacks	Front L/R speakers
CENTER jack	Center speaker
SURROUND jacks	Surround L/R speakers
SURROUND BACK jacks	Surround back L/R speakers
EXTRA SP1 jacks 🌱2	Zone2 speakers
F.PRESENCE (PRE OUT) jacks	External amplifier (for front presence L/R speakers)
SUBWOOFER (PRE OUT) jack 🌱3	Subwoofer

Assigning a speaker configuration

Power Amp Assign	7ch + FPR + 1ZONE
------------------	-------------------

Using the external amplifier to output the rear presence speaker channel

9.1-channel speaker layout

(7 speakers + subwoofer + external rear presence speakers)

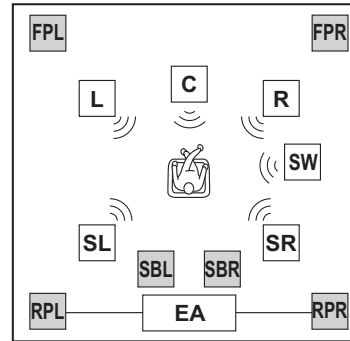

This unit automatically selects the front presence speakers or surround back speakers to output sounds according to the selected sound program. 🌱1
The rear presence speaker channel cannot be output when the front presence speaker channel is not output. 🌱4

Connections of speakers

FRONT jacks	Front L/R speakers
CENTER jack	Center speaker
SURROUND jacks	Surround L/R speakers
SURROUND BACK jacks	Surround back L/R speakers
SUBWOOFER (PRE OUT) jack 🌱3	Subwoofer
R.PRESENCE (ZONE OUT) jacks	External amplifier (for rear presence L/R speakers)
EXTRA SP1 jacks	Front presence L/R speakers

Assigning a speaker configuration

Power Amp Assign	7ch + RPR
------------------	-----------

Using the external amplifier to output the front and rear presence speaker channels

11.1-channel speaker layout

(7 speakers + subwoofer + front and rear presence speakers)

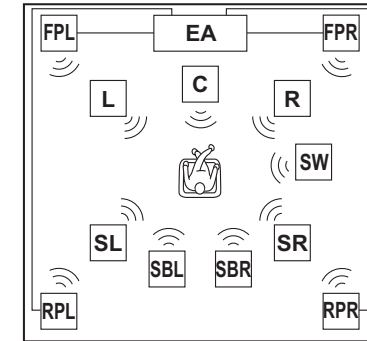

The front and rear presence, surround back and surround speakers can be output at the same time. 🌱4

Connections of speakers

FRONT jacks	Front L/R speakers
CENTER jack	Center speaker
SURROUND jacks	Surround L/R speakers
SURROUND BACK jacks	Surround back L/R speakers
F.PRESENCE (PRE OUT) jacks	External amplifier (for front presence L/R speakers)
SUBWOOFER (PRE OUT) jack 🌱3	Subwoofer
R.PRESENCE (ZONE OUT) jacks	External amplifier (for rear presence L/R speakers)

Assigning a speaker configuration

Power Amp Assign	7ch + FPR + RPR
------------------	-----------------

🌱1 : Sound cannot be output from the surround back speakers when it is output from the speakers connected to the EXTRA SP1 jacks.

🌱2 : EXTRA SP1 jacks can also be assigned to the Zone3 speakers with "Power Amp Assign" (see p. 116).

🌱3 : You can also use two subwoofers by connecting them to both SUBWOOFER1 (FRONT) and SUBWOOFER2 (REAR) jacks.

🌱4 : The sound cannot be output for Zone3 in this condition.

Using the external amplifier to output the front and rear presence speaker channels in main room and front speakers in another room

- 11.1-channel speaker layout (7 speakers + subwoofer + external front and rear presence speakers + front speakers (in secondary zone))

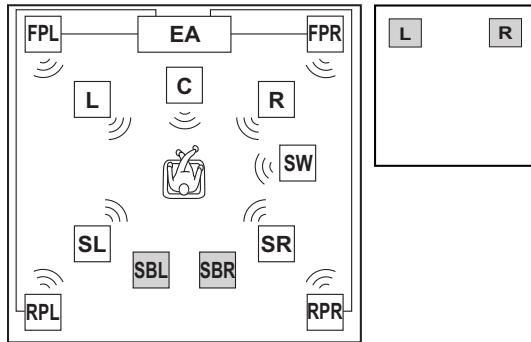

The presence speakers can be used for main room while the front speakers are used for another room. 🌟1 🌟2

Connections of speakers

FRONT jacks	Front L/R speakers
CENTER jack	Center speaker
SURROUND jacks	Surround L/R speakers
SURROUND BACK jacks	Surround back L/R speakers
F.PRESENCE (PRE OUT) jacks	External amplifier (for front presence L/R speakers)
SUBWOOFER (PRE OUT) jack 🌟3	Subwoofer
R.PRESENCE (ZONE OUT) jacks	External amplifier (for rear presence L/R speakers)
EXTRA SP1 jacks 🌟4	Zone2 speakers

Assigning a speaker configuration

Power Amp Assign	7ch + FPR + RPR + 1ZONE
------------------	-------------------------

Using front speakers that support bi-amp connection and front presence speakers

- 7.1-channel speaker layout (Front speaker (Bi-amp) + 3 speakers + subwoofer + external front presence speakers)

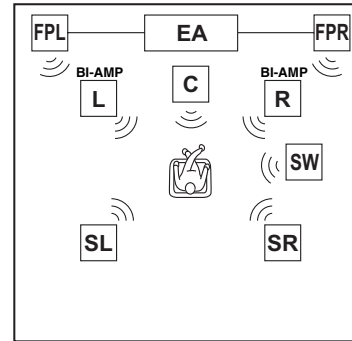

A richer sound field can be created with the simultaneous use of front speakers that support bi-amp connection and front presence speakers.

Connections of speakers

FRONT jacks	Front L/R speakers (bi-amp)
CENTER jack	Center speaker
SURROUND jacks	Surround L/R speakers
SURROUND BACK jacks	Front L/R speakers (bi-amp)
F.PRESENCE (PRE OUT) jacks	External amplifier (for front presence L/R speakers)
SUBWOOFER (PRE OUT) jack 🌟3	Subwoofer

Assigning a speaker configuration

Power Amp Assign	5ch BI-AMP + FPR
------------------	------------------

Using front speakers that support bi-amp connection and surround back speakers

- 7.1-channel speaker layout (Front speaker (Bi-amp) + 3 speakers + subwoofer + external surround back speakers)

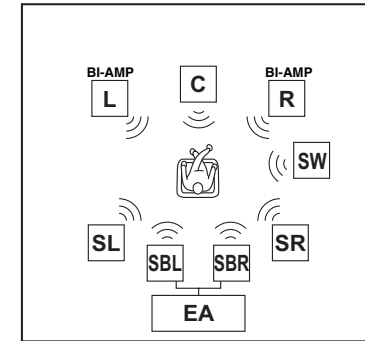

Connecting surround back speakers to an external amplifier enables simultaneous use of front speakers that support bi-amp connection and surround back speakers.

Connections of speakers

FRONT jacks	Front L/R speakers (bi-amp)
CENTER jack	Center speaker
SURROUND jacks	Surround L/R speakers
SURROUND BACK jacks	Front L/R speakers (bi-amp)
SUR.BACK (PRE OUT) jacks	External amplifier (for surround back L/R speakers)
SUBWOOFER (PRE OUT) jack 🌟3	Subwoofer

Assigning a speaker configuration

Power Amp Assign	5ch BI-AMP + SB
------------------	-----------------

🌟1 : Sound cannot be output from the surround back speakers when it is output from the speakers connected to the EXTRA SP1 jacks.

🌟2 : The sound cannot be output for Zone3 in this condition.

🌟3 : You can also use two subwoofers by connecting them to both SUBWOOFER1 (FRONT) and SUBWOOFER2 (REAR) jacks.

🌟4 : EXTRA SP1 jacks can also be assigned to Zone3 speakers with "Power Amp Assign" (p. 116).

Using front speakers that support bi-amp connection, surround back speakers and front presence speakers

9.1-channel speaker layout

(Front speaker (Bi-amp) + 3 speakers + subwoofer + external surround back speakers + external front presence speakers)

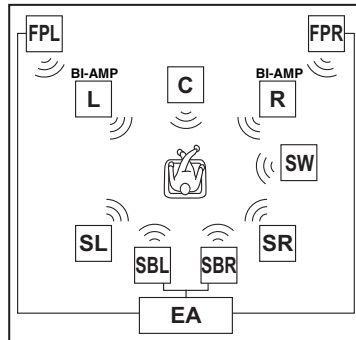

When an external amplifier is used, front presence speakers and surround back speakers can be used simultaneously with front speakers that support bi-amp connection. 🌟1

Connections of speakers

FRONT jacks	Front L/R speakers (bi-amp)
CENTER jack	Center speaker
SURROUND jacks	Surround L/R speakers
SURROUND BACK jacks	Front L/R speakers (bi-amp)
SUR.BACK (PRE OUT) jacks	External amplifier (for surround back L/R speakers)
F.PRESENCE (PRE OUT) jacks	External amplifier (for front presence L/R speakers)
SUBWOOFER (PRE OUT) jack 🌟2	Subwoofer

Assigning a speaker configuration

Power Amp Assign	5ch BI-AMP + SB + FPR
------------------	-----------------------

Using the front speakers that support bi-amp connections, the external amplifier to output the front and rear presence channels

9.1-channel speaker layout

(Front speaker (Bi-amp) + 3 speakers + subwoofer + external front and rear presence speakers)

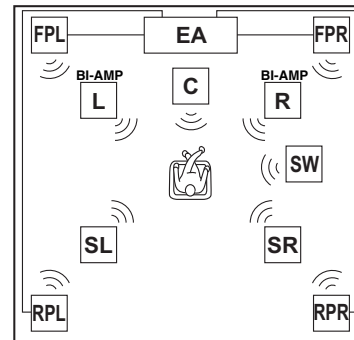

Using the external amplifier can enable to use the front and rear presence speakers while using the front speakers that support bi-amp connections. 🌟1 🌟3

Connections of speakers

FRONT jacks	Front L/R speakers (bi-amp)
CENTER jack	Center speaker
SURROUND jacks	Surround L/R speakers
SURROUND BACK jacks	Front L/R speakers (bi-amp)
F.PRESENCE (PRE OUT) jacks	External amplifier (for front presence L/R speakers)
SUBWOOFER (PRE OUT) jack 🌟2	Subwoofer
R.PRESENCE (ZONE OUT) jacks	External amplifier (for rear presence L/R speakers)

Assigning a speaker configuration

Power Amp Assign	5ch BI-AMP + FPR + RPR
------------------	------------------------

🌟1: An external amplifier equipped with four channels is required for this speaker layout.

🌟2: You can also use two subwoofers by connecting them to both SUBWOOFER1 (FRONT) and SUBWOOFER2 (REAR) jacks.

🌟3: The sound cannot be output for Zone3 in this condition.

Connecting an external amplifier

The same channel signals are output from the jacks of the PRE OUT and ZONE OUT terminals as from their corresponding SPEAKERS terminals. When connecting an external power amplifier (pre-main amplifier) to enhance speaker output, connect the input terminals of the power amplifier to the PRE OUT and ZONE OUT terminals of this unit.

NOTES

- When a component is connected to the PRE OUT and ZONE OUT terminals, do not connect speakers to the SPEAKERS terminals corresponding to those PRE OUT and ZONE OUT terminals.
- When an external amplifier equipped with a volume adjustment function is connected, a sufficient volume level may not be achieved.

Use of the following components is recommended.

- An amplifier with no volume adjustment function.
- An integrated amplifier equipped with a function that bypasses volume circuitry, such as the Yamaha A-S2000 with MAIN IN input.

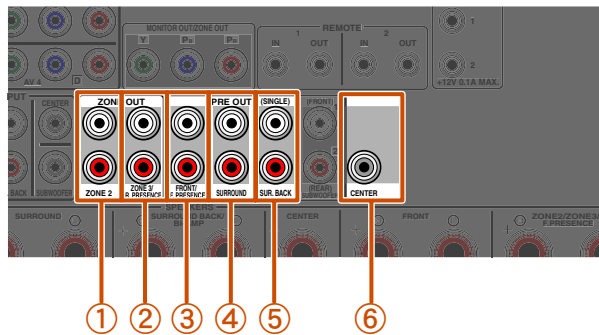

- ① **ZONE2 jacks**
Zone2 channel output jacks.
- ② **ZONE3/R.PRESENCE jacks**
Zone3 channel or rear presence channel output jacks.
- ③ **FRONT/F.PRESENCE (PRE OUT) jacks**
Front channel or front presence channel output jacks.
- ④ **SURROUND (PRE OUT) jacks**
Surround channel output jacks.
- ⑤ **SUR. BACK (PRE OUT) jacks**
Surround back output jacks. When you only connect one external amplifier for the surround back channel, connect it to the SUR. BACK (SINGLE) jack.
- ⑥ **CENTER (PRE OUT) jack**
Center channel output jack.

Connecting external components

Jacks and cables

This unit is equipped with the following input/output jacks. Use jacks and cables appropriate for components that you are going to connect.

Audio/Video jacks

HDMI jacks

Digital video and digital sound are transmitted through a single jack.
Only use an HDMI cable.

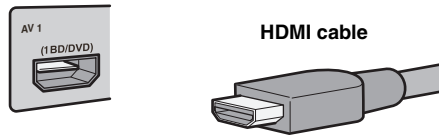

- Use a 19-pin HDMI cable with the HDMI logo.
- We recommend using a cable less than 16.4 ft. (5.0 m) long to prevent signal quality degradation.
- When a TV that supports HDMI functions and Audio Return Channel function is connected, audio output from the TV can be input to this unit ([p. 150](#)).
- When a player and TV that support the 3D video format are connected to this unit, 3D content can be played back.
- If you connect this unit to a component that has a DVI jack, an HDMI/DVI-D cable is required.

Analog video jacks

COMPONENT VIDEO jacks

The signal is separated into three components: luminance (Y), chrominance blue (PB), and chrominance red (PR).
Use component video pin cables with three plugs.

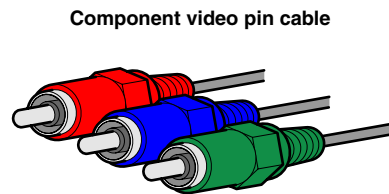
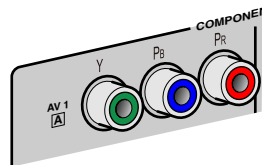

S-VIDEO jacks

To transmit S-video signals that include luminance (Y) and chrominance (C) components.
Use S-video cables.



S-video cable

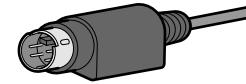

VIDEO jacks

These jacks transmit conventional analog video signals.
Use video pin cables.

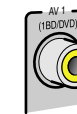

Video pin cable

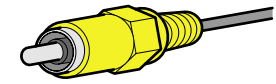

Audio jacks

OPTICAL jacks

These jacks transmit optical digital audio signals.
Use fiber-optic cables for optical digital audio signals.



Digital audio fiber-optic cable



COAXIAL jacks

These jacks transmit coaxial digital audio signals.
Use pin cables for digital audio signals.



Digital audio pin cable

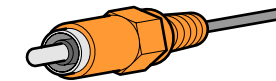

AUDIO jacks

These jacks transmit conventional analog audio signals.
Use stereo pin cables, connecting the red plug to the red R jack, and the white plug to the white L jack.



Stereo pin cable

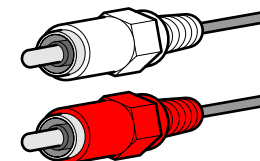

Connecting a TV monitor

This unit is equipped with the following four types of output jack for connection to a TV. HDMI OUT 1-2, COMPONENT VIDEO, S-VIDEO or VIDEO. Select the proper connection according to the input signal format supported by your TV.

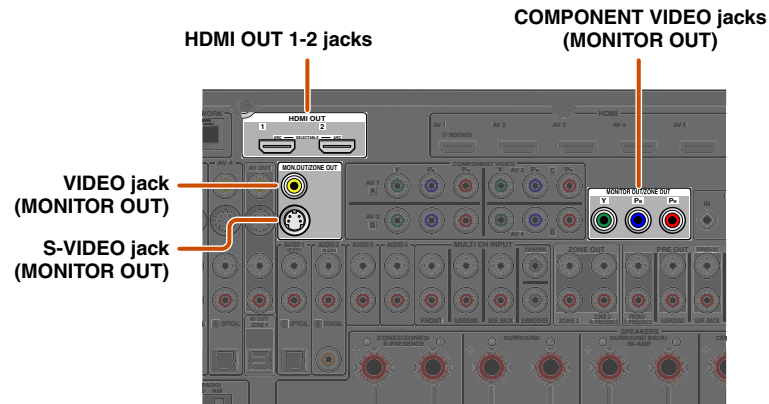

When connecting to an HDMI compatible TV

Video signal such as component video, S-video and video received by this unit is converted to HDMI and output to the TV. Just select HDMI input on the TV to view video from any external source connected to this unit. 🌟1

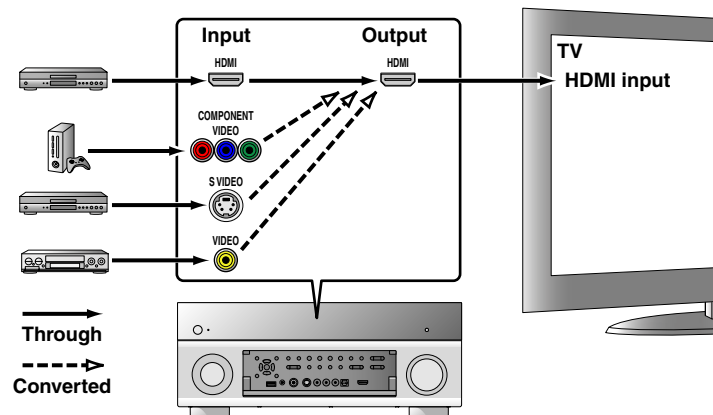

🌟 1 : You can change the resolution and aspect ratio when converting to HDMI to suit your requirements (see p. 121).

🌟 2 : Set "Analog to Analog Conversion" to "On" (see p. 121).

🌟 3 : Analog to analog conversion is available only for 480i/576i-resolution video signal.

When connecting to a non-HDMI compatible TV

Connect to the TV using the same type of connection that you used to connect to the external component, and change the inputs on your TV to match that of the external component you are using for playback. If the external component and TV are equipped with different types of analog video jacks, this unit will convert the component video, S-video or video signal to component video, S-video or video signal, according to the type of video input jacks used by the TV. 🌟2, 🌟3

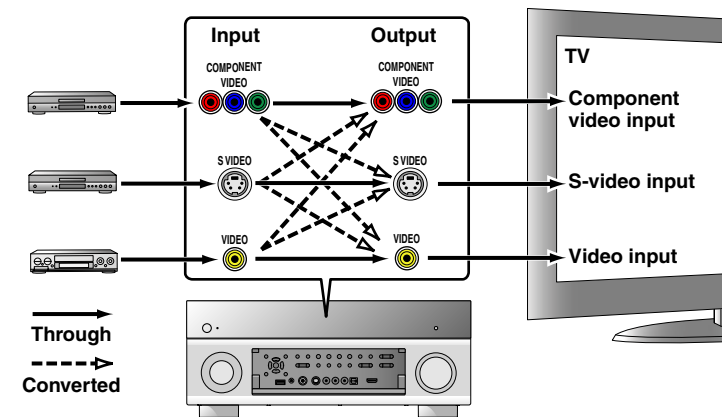

■ Connecting an HDMI video monitor

Connect the HDMI cable to one of the HDMI OUT 1-2 jacks.

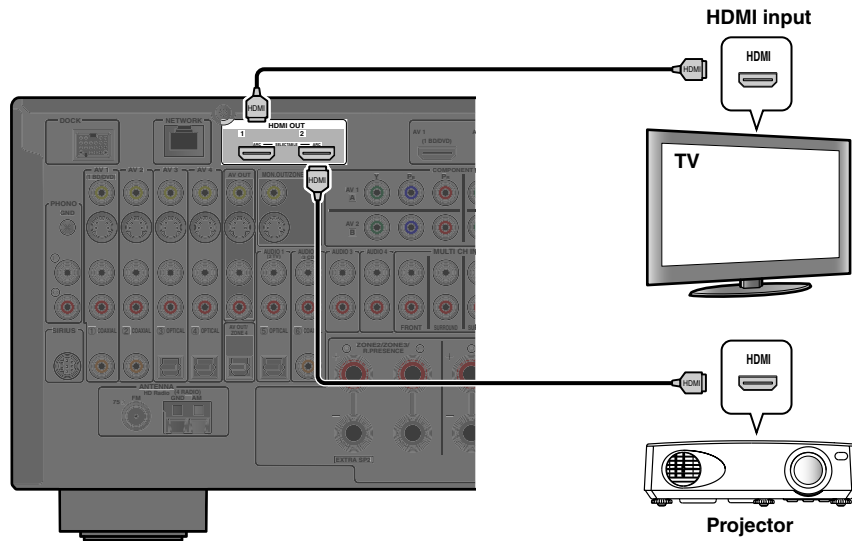

■ Connecting a component video monitor

Connect the component video cable to the COMPONENT VIDEO (MONITOR OUT) jacks.

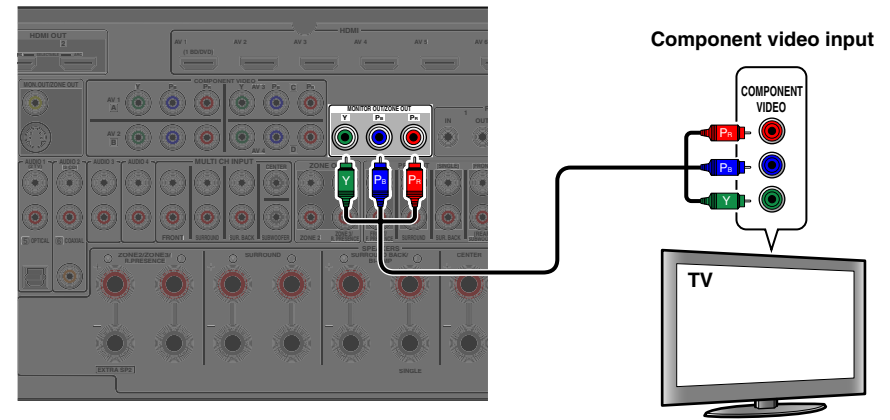

■ Connecting a S-video monitor

Connect the S-video cable to the S-VIDEO (MONITOR OUT) jack.

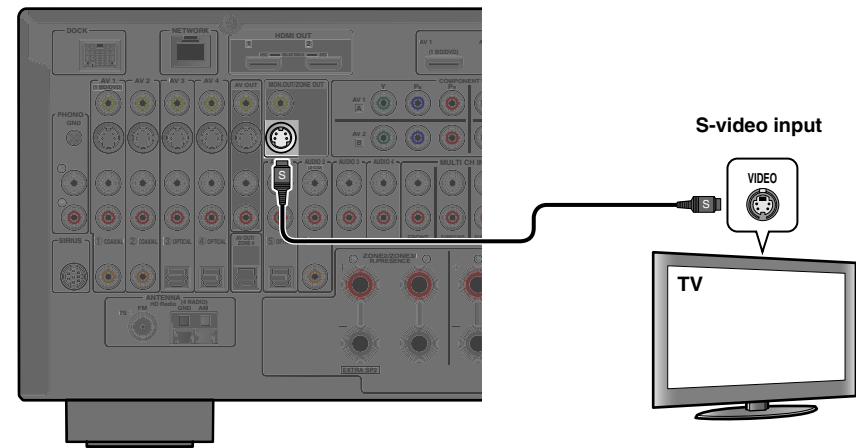

- Use a 19-pin HDMI cable with the HDMI logo.
- We recommend using a cable less than 16.4 ft. (5.0 m) long to prevent signal quality degradation.
- When a TV that supports the HDMI function and Audio Return Channel function is connected, audio output from the TV can be input to this unit ([p. 150](#)).
- When a player and TV that support the 3D video format are connected to this unit, 3D content can be played back.
- This unit is equipped with HDMI OUT 1 and 2 jacks. The active HDMI OUT jack(s) can be selected ([p. 52](#)). The active HDMI OUT jack(s) can be registered with the SCENE function ([p. 106](#)).

 1 : The video signal for the COMPONENT VIDEO or S-VIDEO jacks is converted and output from HDMI OUT 1-2 jacks. When connecting to a TV via the HDMI jack, you do not need to use these jacks.

■ Connecting a video monitor

Connect the video pin cable to the VIDEO (MONITOR OUT) jack.

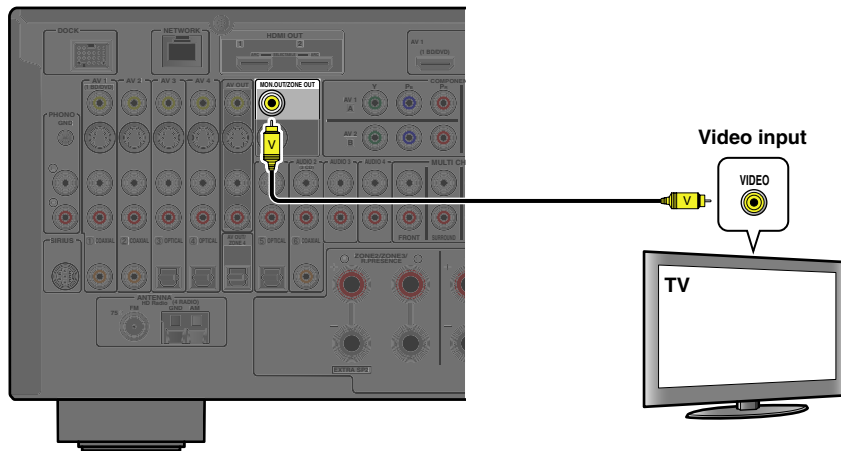

■ Listening to TV audio

To transmit sound from the TV to this unit, connect as followings according to the TV:

When using a TV that supports the Audio Return Channel function and HDMI Control function

When your TV supports both HDMI Control (e.g., Panasonic VIERA Link) and Audio Return Channel functions, audio/video output from the unit to the TV and audio output from the TV to the unit are possible using a single HDMI cable.

The input source is switched automatically to match operations carried out on the TV, and that makes TV sound control easier to use.

For the connections and settings, refer to “Single HDMI cable input to TV audio with Audio Return Channel function” ([p. 150](#)).

When using a TV that supports the HDMI Control functions

When using a TV that supports HDMI Control functions (e.g., Panasonic VIERA Link), if HDMI Control functions are enabled on the unit, then input source can be switched automatically to match operations carried out on the TV.

For the connections and settings, refer to “Switching the input source on this unit automatically when listening to TV audio” ([p. 149](#)).

When using other TVs

To transmit sound from the TV to this unit, connect the TV’s audio output to the AUDIO1-4 jacks.

TV audio output	Connection
Optical digital audio output	Connect to the OPTICAL jack of the AUDIO1 with a fiber-optic cable.
Coaxial digital audio output	Connect to the COAXIAL jack of the AUDIO2 with a digital audio pin cable.
Analog stereo output	Connect to one of the AUDIO1-4 with a stereo pin cable.

Select the input source connected via TV’s audio output jack to enjoy the TV sound.

If the TV supports optical digital audio output, we recommend that you connect the TV audio output to the receiver’s AUDIO1 jack.

Connecting to AUDIO1 allows you to switch the input source to AUDIO1 with just a single key operation using the SCENE function ([p. 54](#)).

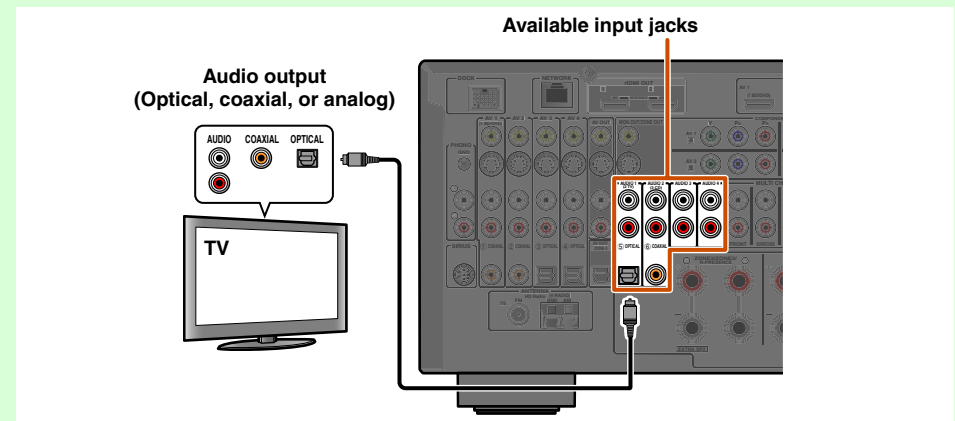

You can control your TV using the receiver’s remote control by entering the TV’s remote control code ([p. 136](#)).

 1 : The video signal for the VIDEO jacks is converted and output from HDMI OUT 1-2 jacks. When connecting to a TV via the HDMI jack, you do not need to use these jacks.

Connecting BD/DVD players and other devices

This unit has the following input jacks. Connect them to the appropriate output jacks on the playback devices such as BD/DVD players.

Input jack	Video input	Audio input
AV1	HDMI/Component video/S-video/Video	HDMI/Coaxial digital/Analog (Stereo)
AV2	HDMI/Component video/S-video/Video	HDMI/Coaxial digital/Analog (Stereo)
AV3	HDMI/Component video/S-video/Video	HDMI/Optical digital/Analog (Stereo)
AV4	HDMI/Component video/S-video/Video	HDMI/Optical digital/Analog (Stereo)
AV5	HDMI	HDMI
AV6	HDMI	HDMI
AV7	HDMI	HDMI
AUDIO1	—	Optical digital/Analog (Stereo)
AUDIO2	—	Coaxial digital/Analog (Stereo)
AUDIO3	—	Analog (Stereo)
AUDIO4	—	Analog (Stereo)
VIDEO AUX	HDMI/S-video/Video	HDMI/Optical digital/Analog (Stereo)
PHONO	—	Analog (Only for connecting a turntable)

Connecting BD/DVD players and other devices with HDMI cable

Connect the device with an HDMI cable to one of the HDMI jacks of the AV1-7. The HDMI IN jack of the VIDEO AUX on the front panel can also be used. Select the input source (AV1-7 or V-AUX) that the playback device is connected to for playback.

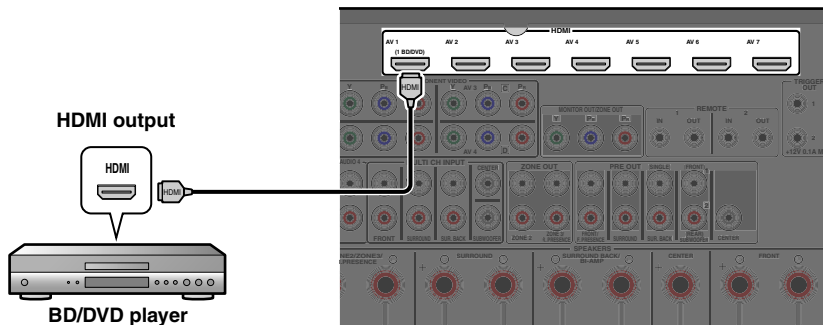

Receiving video signals from the HDMI jack and audio signals from jacks other than HDMI

This unit can use the AV1-4 or AUDIO1-4 input jacks to receive audio signals from other input jacks.

For example, if a playback device cannot produce audio signals from an HDMI jack, use the following method to change the audio input.

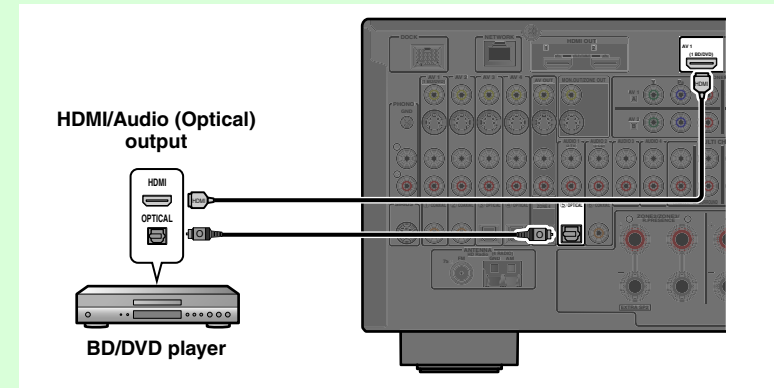

- Press **[4]** **Input selector** to choose an input source (AV1-4, V-AUX, AUDIO1-4, or PHONO).
- Press **[16]** **OPTION** to enter the Option menu.
- Press **[9]** **Cursor** Δ / ∇ to choose "Audio Select" and press **[9]** **ENTER**.
- Press **[9]** **Cursor** \leftarrow / \rightarrow to choose an audio input jack and press **[9]** **ENTER**.
- Once setup is complete, press **[16]** **OPTION** to close the Option menu.

1: Coaxial digital and optical digital jacks function can be assigned to other AV jacks using "Input Assignment." Refer to "Input Assignment" for details ([see p. 129](#)).

Connecting BD/DVD players and other devices with component video cables

Connect the device with a component video cable to one of the AV1-4 input jacks.

Using optical digital audio output sources

Connect the playback device to the AV3 or AV4 jacks.

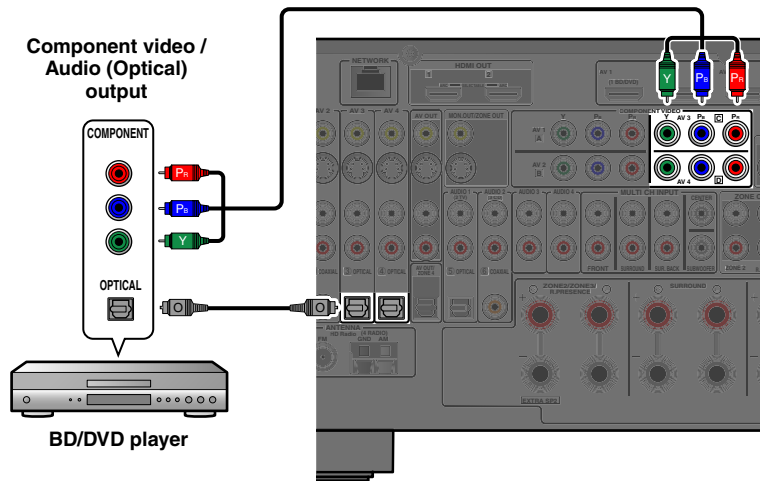

Using coaxial digital audio output sources

Connect the playback device to the AV1 or AV2 jacks.

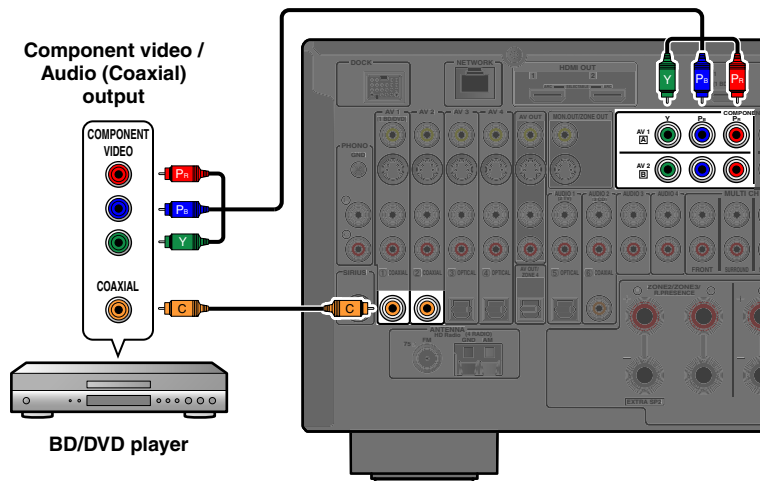

Using analog stereo audio output sources

Connect the playback device to the AV1, AV2, AV3 or AV4 jacks.

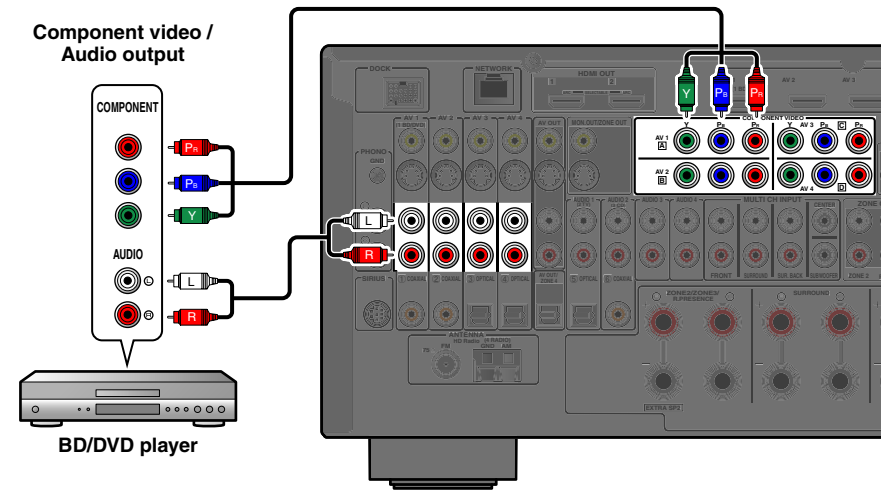

Connecting BD/DVD players and other devices with S-video cables

Connect the playback device with a S-video cable to one of the AV1-4 input jacks.

Using optical digital audio output sources

Connect the playback device to the AV3 or AV4 jacks.

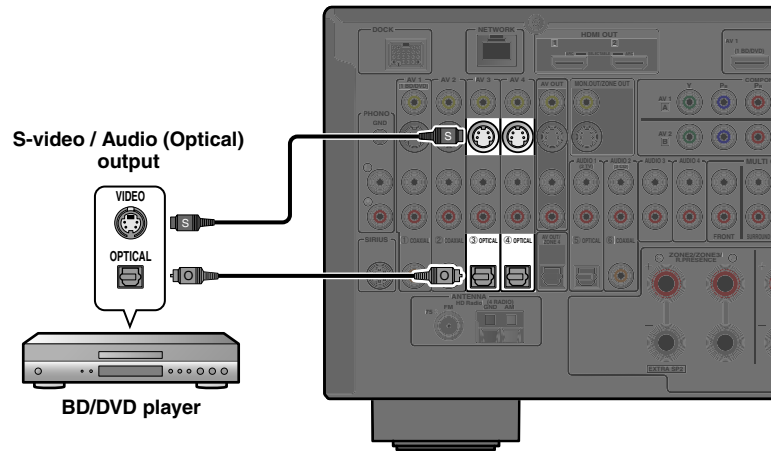

Using coaxial digital audio output sources

Connect the playback device to the AV1 or AV2 jacks.

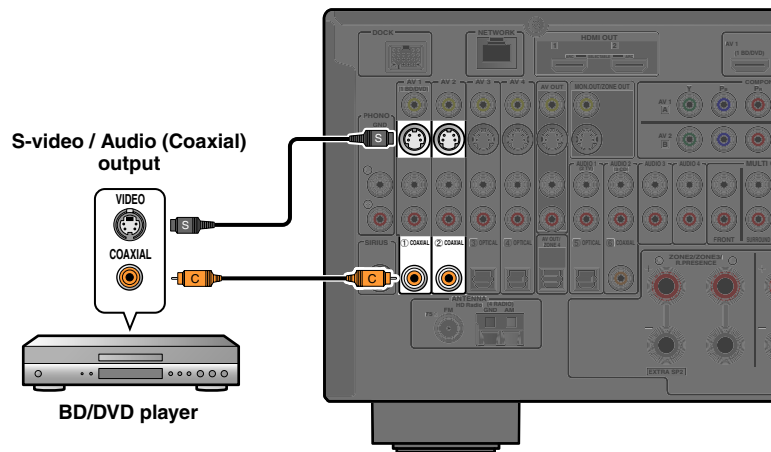

Using analog stereo audio output sources

Connect the playback device to the AV1, AV2, AV3 or AV4 jacks.

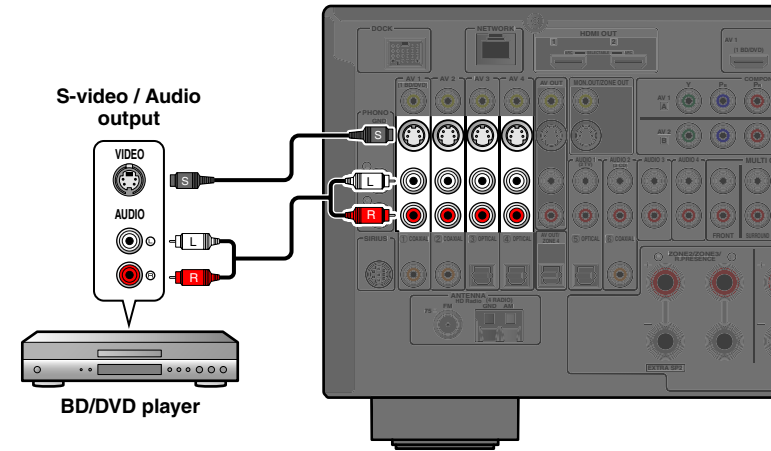

Connecting BD/DVD players and other devices with video cables

Connect the playback device with a video pin cable to one of the AV1-4 input jacks.

Using optical digital audio output sources

Connect the playback device to the AV3 or AV4 jacks.

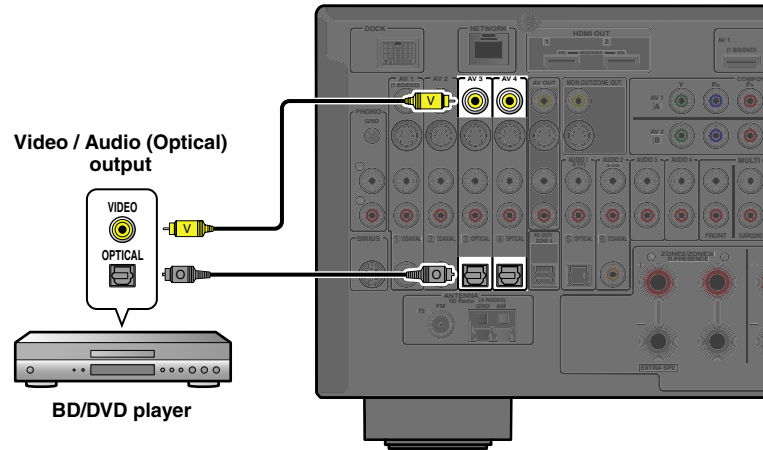

Using analog stereo audio output sources

Connect the playback device to the AV1, AV2, AV3 or AV4 jacks.

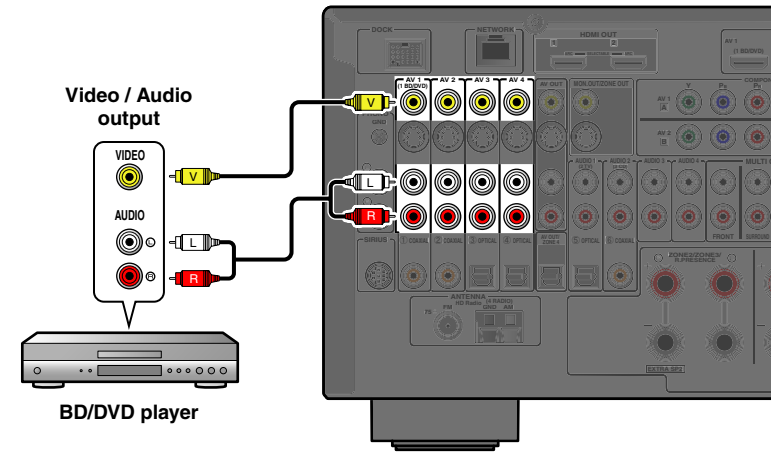

Using coaxial digital audio output sources

Connect the playback device to the AV1 or AV2 jacks.

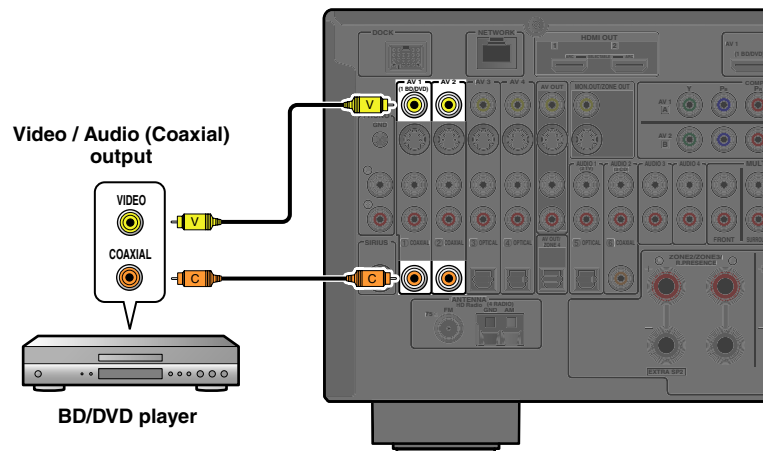

Connecting CD players and other audio devices

Using analog stereo output sources

Connect the playback device to the AUDIO1, AUDIO2, AUDIO3 or AUDIO4 jacks.

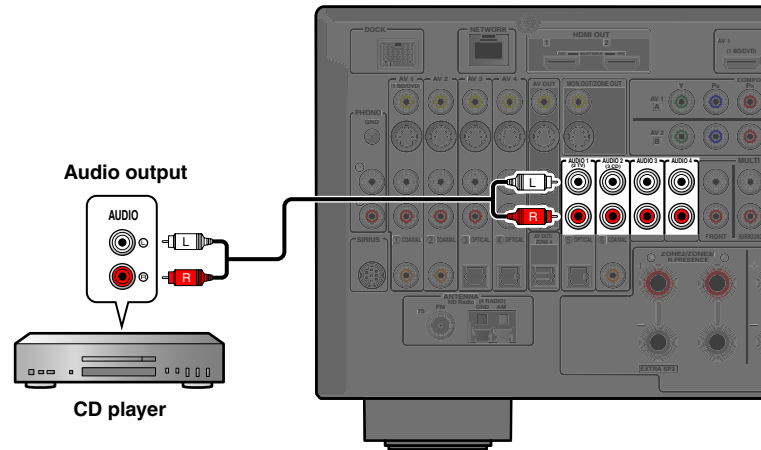

Using optical digital output sources

Connect the playback device to the AUDIO1 jack.

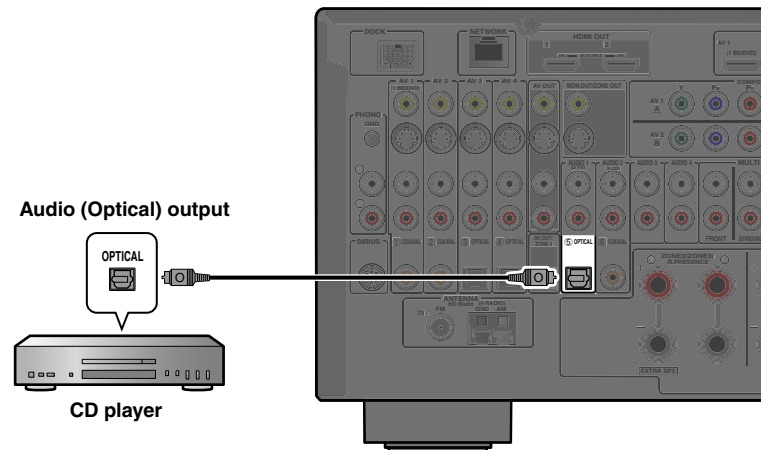

Using coaxial digital output sources

Connect the playback device to the AUDIO2 jack.

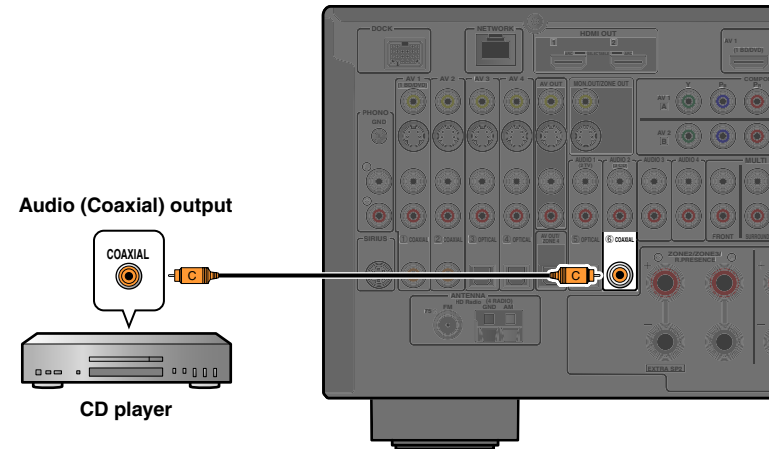

We recommend connecting audio devices with a coaxial digital output to the AUDIO2 coaxial digital jack on this unit. This connection allows you to switch to the AUDIO2 just by pressing the SCENE 3 key ([step. 54](#)).

Connecting a turntable

Connect the audio output of the turntable to PHONO jacks of this unit. 💡1

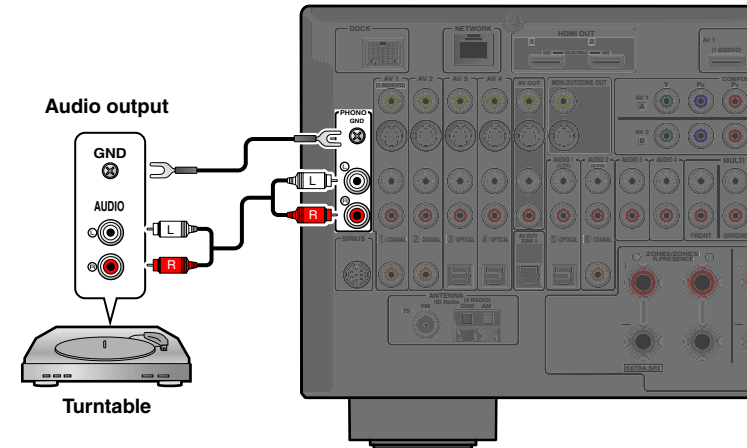

Connect your turntable to the GND terminal of this unit to reduce noise in the signal.

💡 1 : When connecting a turntable with a low-output MC cartridge to the PHONO jacks, use an in-line boosting transformer or MC-head amplifier.

Connecting game consoles or video camcorders

Use the VIDEO AUX jacks on the front panel to temporarily connect devices such as a game console or video camcorder to the receiver.

Select the V-AUX input to use these connected devices.

When connecting an HDMI compatible device

Connect the HDMI output of the device to the HDMI IN jack of the VIDEO AUX.

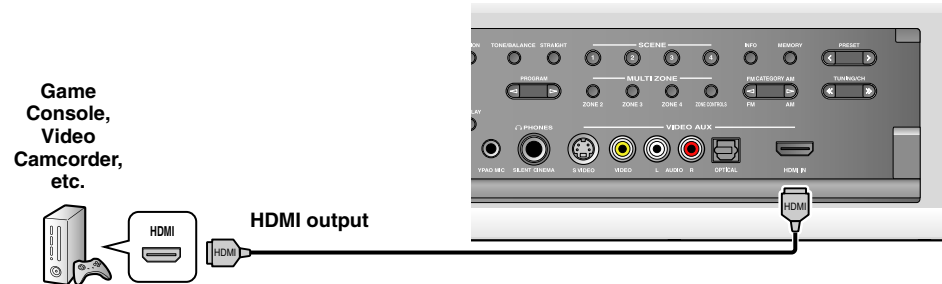

When connecting a non-HDMI compatible device

Connect the video and audio outputs of the device to the VIDEO or S-VIDEO, and AUDIO or OPTICAL jacks of the VIDEO AUX.

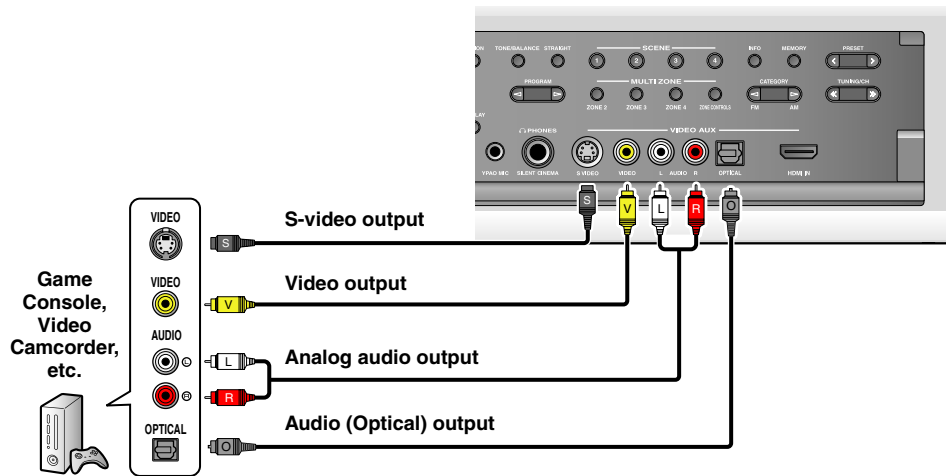

Connecting a multi-format player or an external decoder

This unit has 8 sets of input jacks (FRONT L/R, CENTER, SURROUND L/R, SUR. BACK and SUBWOOFER) to input multi-channel analog sound signals. If your playback component, such as a DVD player or SACD player, has multi-channel analog output capability, you can enjoy up to 7.1-channel multi-channel sound. To output multi-channel sound, connect the audio output jacks of your playback component to the MULTI CH INPUT jacks of this unit, and set the input source of this unit to "MULTI CH."

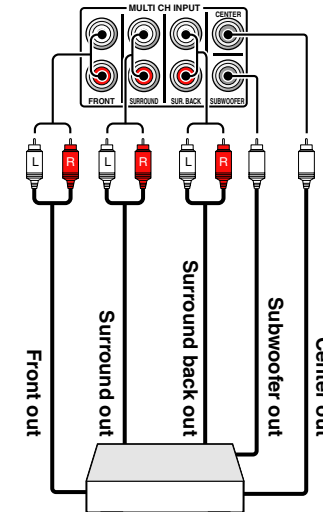

Multi-format player/External decoder (7.1-channel output)

- When you select "MULTI CH" as the input source, the digital sound field processor and tone control are automatically disabled.
- As this unit does not redirect signals input through the MULTI CH INPUT jacks to compensate for missing speakers, make appropriate settings on the multi-format player or the external decoder that suit to the speaker configuration.
- When the input source is switched to "MULTI CH," images input from a component connected to the AV1-7 or VIDEO AUX jacks can be displayed on a video monitor (see p. 105). If your DVD player does not support multi-channel digital output, connect it to these input jacks.

- Be sure to turn down the volume when connecting this unit and the other devices.
- When both the HDMI connection and the analog video/audio connection are performed between the HDMI compatible device and this unit, only the HDMI signal will be input.

Connecting a SCENE link playback-compatible device

When the components are the Yamaha products and have the capability of the transmission of the remote control signals, connect the REMOTE IN and REMOTE OUT jacks to the remote control input and output jack with the monaural analog mini cable as follows.

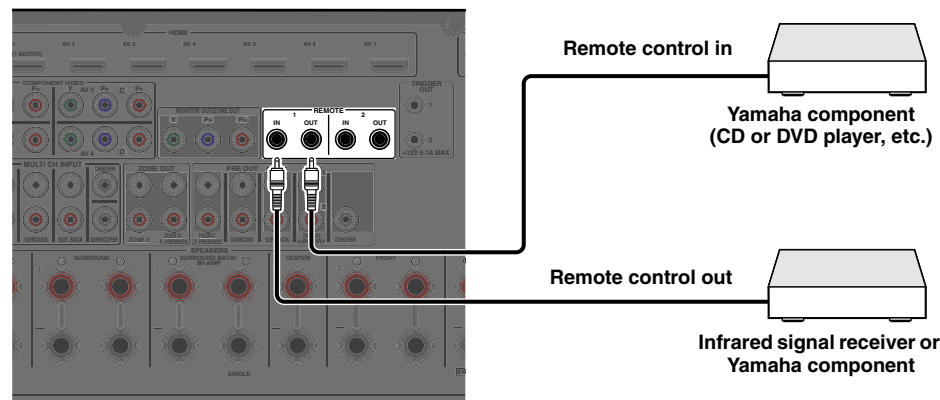

- When a Yamaha component that supports the SCENE link playback function is connected via the REMOTE OUT jack, playback begins automatically when the SCENE function is used ([p. 54](#)).
- If the component connected to the REMOTE OUT jack is not a Yamaha product, set “SCENE IR” in the Scene menu to “Off” ([p. 107](#)).

Using the Trigger function to link external component power

When this unit is connected to a Yamaha subwoofer that supports the system connection or the component with TRIGGER IN jack, you can turn on and off the component by using this unit.

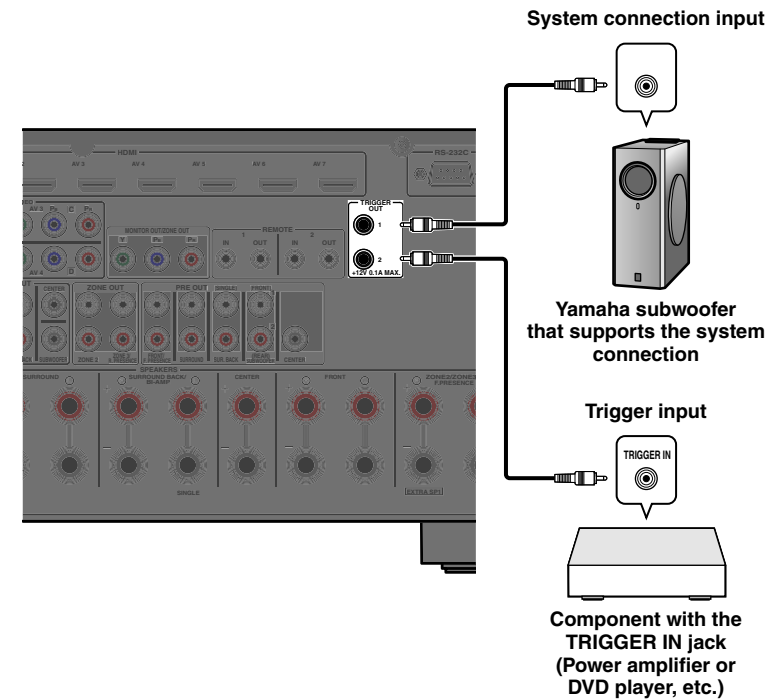

Functions of the TRIGGER OUT jack can be specified ([p. 130](#)).

Connecting audio/video recording devices

This receiver can transmit selected incoming audio/video signals to external components through the AV OUT jacks. You can record these input audio and video signals to VCRs or similar devices, or send them to other TVs or external components.

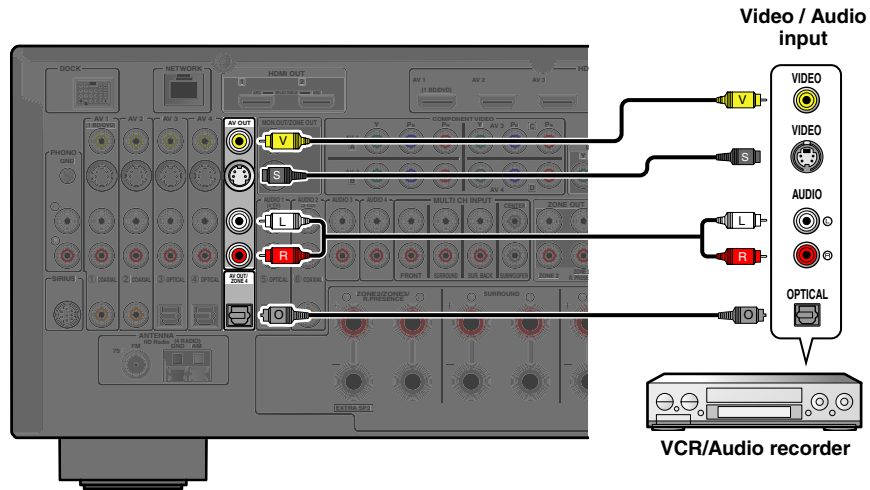

HDMI audio/video signals and component video signals cannot be transmitted from these jacks.

Connecting to the network

To connect this unit to your network, plug one end of a network cable (CAT-5 or higher straight cable) into the NETWORK port of this unit, and plug the other end into one of the LAN ports on your router that supports the DHCP (Dynamic Host Configuration Protocol) server function. To enjoy Internet Radio or music files saved on PC and DLNA server such as NAS (Network Attached Storage), each device must be connected properly in the network.

- Use an STP (shielded twisted pair) cable (commercially available) to connect a network hub or router and this unit.
- If the DHCP server function on your router is disabled, you need to configure the network settings manually ([p. 125](#)).

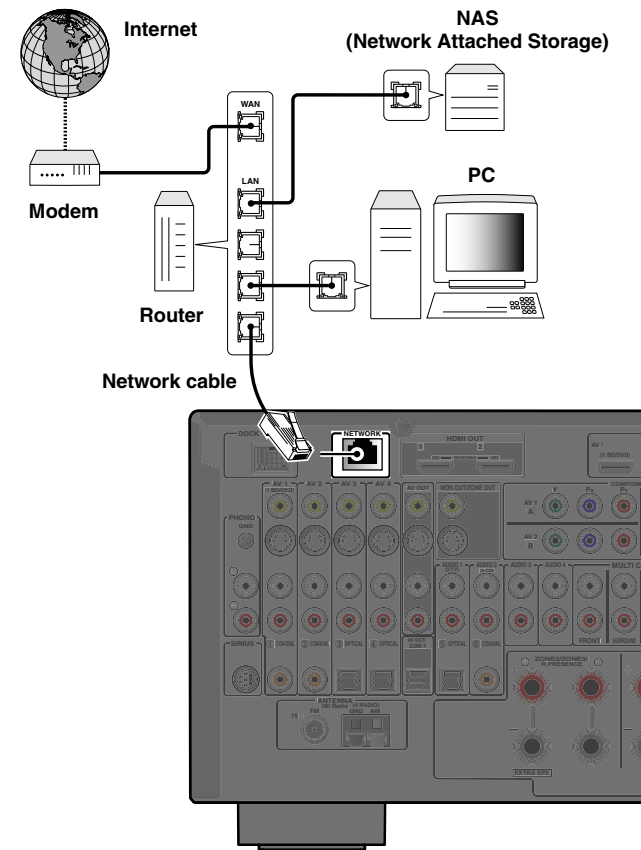

Connecting a USB storage device

Connect a USB memory device or USB portable audio player to the USB port on the front panel of this unit.

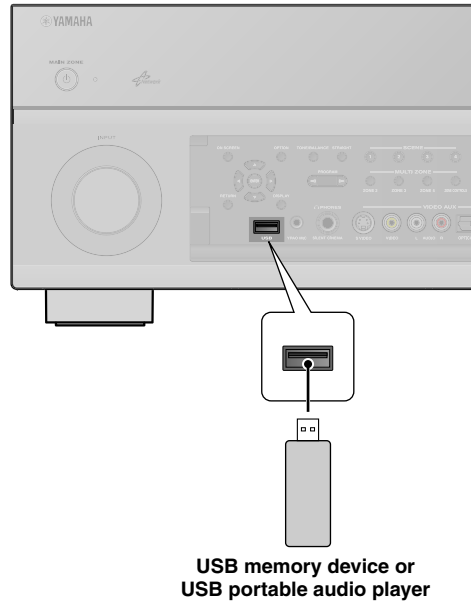

NOTE

Be careful that the USB storage device is facing the correct way when inserted into the USB port of this unit.

Connecting the FM/AM antennas

An indoor FM antenna and an AM loop antenna are supplied with this receiver. Connect these antennas properly to their respective jacks.

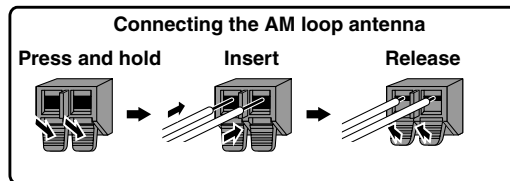
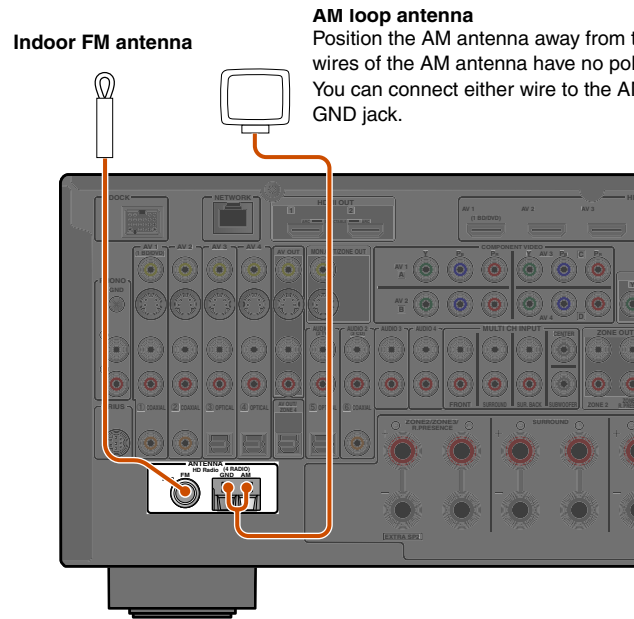

Assembling the AM loop antenna

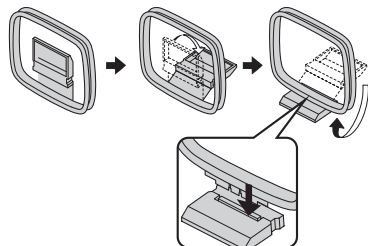

■ Improving FM reception

We recommend using an outdoor antenna. For more information, consult the nearest authorized dealer.

■ Improving AM reception

Connect this unit to an outdoor antenna with a 16.4 – 32.8 ft. (5 – 10 m) vinyl-coated wire. Make sure the AM loop antenna is still connected.
Connecting the GND jack can reduce noise. Connect the jack to a store-bought ground bar or copper plate with a vinyl-covered wire and bury this new attachment in moist ground.
The GND jack is not to be connected to the ground socket of an electrical outlet.

Setting up the speaker parameters automatically (YPAO)

This unit is equipped with a Yamaha Parametric Room Acoustic Optimizer (YPAO) that adjusts the configuration, size, and volume balance of the speakers in order to provide an optimal sound field. Using YPAO allows you to automatically configure settings, such as adjusting speaker output and acoustic parameters to suit your listening room (the room in which this unit is placed). 1

Be aware of the following when using YPAO.

- The amount of time for measurement varies from about two to ten minutes according to settings.
- The test tone is output at high volume. Refrain from using this function at night when it may be a nuisance to others.
- Take care that the test tone does not frighten small children.

YPAO operations can be viewed on the front panel display or TV screen.

1 Check the following before using YPAO.

This unit

- The headphones are removed.

TV

- This unit is connected to the TV correctly.
- The power is turned on.
- The video input to which the video output from this unit has been selected.

Subwoofer

- The power is turned on.
- Volume is set to approximately half, and the cross-over frequency (if present) is set to maximum.

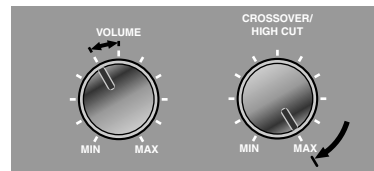

Subwoofer examples

Power amp assign

- “Power Amp Assign” applies the appropriate speaker settings to this unit according to speaker configuration. Refer to “Speaker layout” and “Speaker layout utilizing an external power amplifier” for details ([p. 16](#), [p. 24](#)).

2 Place the supplied YPAO microphone at ear height in your listening position.

Face the head of the YPAO microphone upwards.

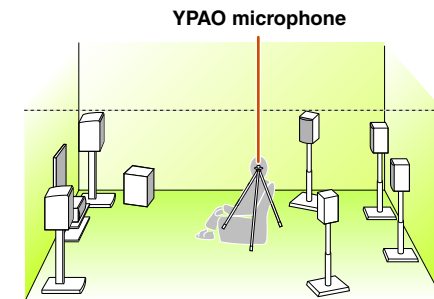

When positioning the microphone, we recommend that you use equipment that allows you to adjust the height (such as a tripod) as a microphone stand. When using a tripod, use the tripod screws to fix the microphone in place.

3 Switch this unit on.

Continues to the next page

 1: When you have changed the number of speakers or the locations in which they are installed, first use YPAO to adjust the speaker balance.

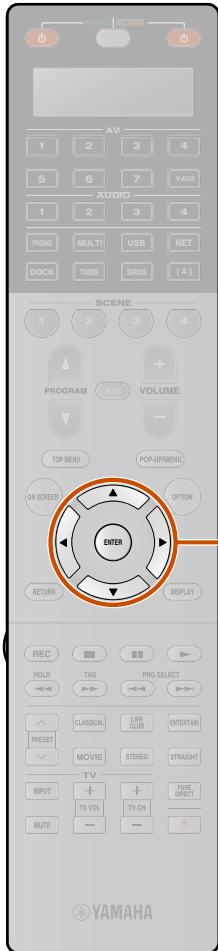

4 Connect the YPAO microphone to the YPAO MIC jack on the front panel.

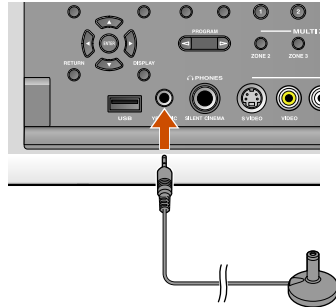

“Mic On View ON SCREEN” appears on the front panel display, and the following display appears on the front panel display or TV screen.

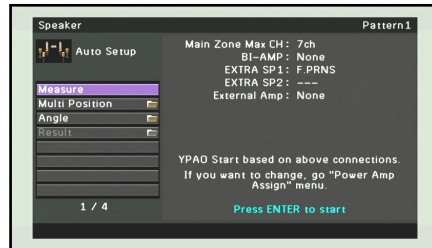

5 Press **9**Cursor Δ / ∇ to select the “Multi Position” and press **9**ENTER to set the number of listening positions to measure.

To measure at the multiple listening positions (up to 8), press **9**Cursor Δ / ∇ to select “Yes” and press **9**ENTER.

To measure at one listening position, press **9**Cursor Δ / ∇ to select “No” and press **9**ENTER.

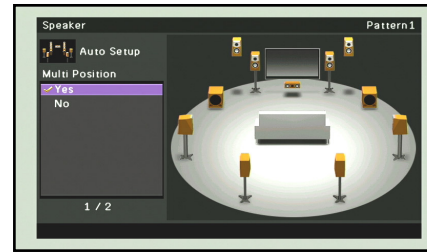

6 Press **9**Cursor Δ / ∇ to select the “Angle” and press **9**ENTER to select whether or not to measure the angle of speakers.

To measure the angle of speakers, press **9**Cursor Δ / ∇ to select “Yes” and press **9**ENTER.

To not measure the angle of speakers, press **9**Cursor Δ / ∇ to select “No” and press **9**ENTER.



This completes preparation. To achieve more accurate results, take note of the following when measuring acoustics.

- It takes a few minutes for one position to accurately measure acoustics for one position. Keep the room as quiet as possible while acoustics are measured.
- Wait in a corner of the room, or leave it entirely, while acoustics are measured to avoid creating an obstruction between the speakers and the YPAO microphone.

Continues to the next page





7 Press **[9]Cursor** Δ / ∇ repeatedly to select the “Measure” and press **[9]ENTER** to start measurement.

Auto measurement starts in 10 seconds.

- To start the measurement immediately, press **[9]ENTER** again.
- To cancel the automatic setup, press **[9]RETURN** and then **[9]ENTER**.

Display during measurement

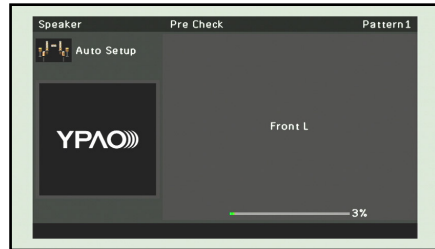

NOTE

If a problem occurs, an error message or report is displayed either during or after acoustic measurement. Refer to “When an error message is displayed during measurement” (p. 49), or “When a warning message is displayed after measurement” (p. 50) to resolve the problem and measure acoustics with YPAO again.

■ When “Multi Position” is set to “No” in step 5

The calculation based on result of measurement starts when measurement finishes without any problem.

When “Angle” is set to “No” in step 6

The following display appears when the calculation finishes without any problems.

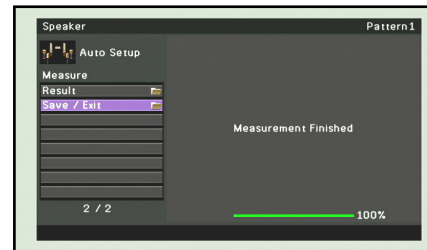

Go to step 14.

■ When “Angle” is set to “Yes” in step 6

The following display appears when the calculation finishes without any problems.

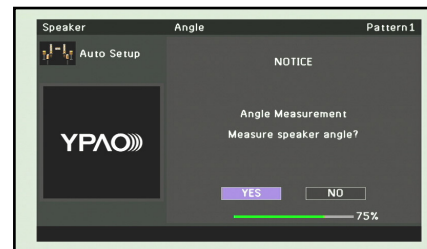

Go to step 9.

■ When “Multi Position” is set to “Yes” in step 5

The following display appears when measurement at the first position finishes without any problems.

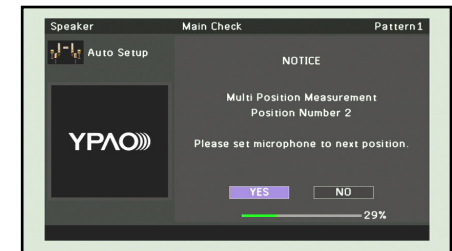

Go to step 8.

Continues to the next page



8 Replace the optimizer microphone at your choosing position and press **ENTER** to restart the automatic measurement.

Auto measurement restarts in 10 seconds.

The following illustration shows how to place the optimizer microphone to optimize the setup of this unit for eight listening positions for example. Up to 8 listening positions can be measured. 1

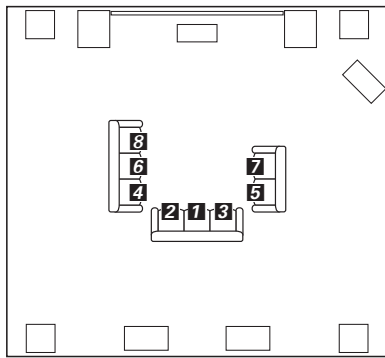

Repeat step 8 until the measurement at all listening positions are made.

The calculation based on result of measurement starts when measurement at the last position finishes without any problem.

When “Angle” is set to “No” in step 6

The following display appears when the calculation finishes without any problems.

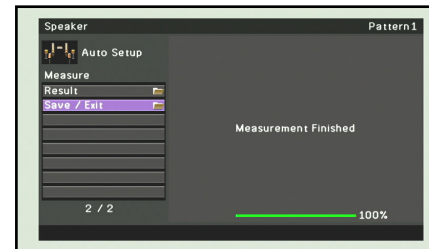

Go to step 14.

When “Angle” is set to “Yes” in step 6

The following display appears when the calculation finishes without any problems.

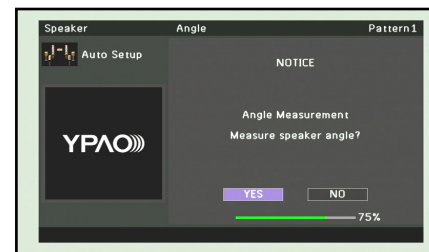

Go to step 9.

9 Press **Cursor** to select “YES” and press **ENTER**.

The following display appears.



Continues to the next page

1 : Measure from the most frequent listening position, such as directly in front of the TV, first.



10 Place the supplied microphone base at the listening position you want to be seated most frequently as follows.

Make sure that the arrow mark on the microphone base points the center speaker or between the front left and right speakers.

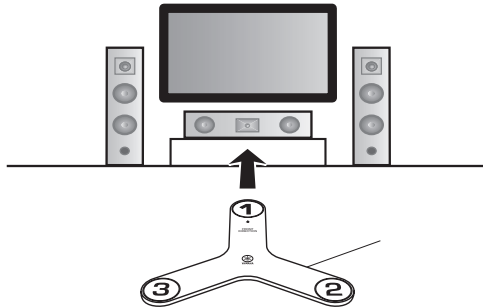

For the accurate measurements of the speaker angles, we strongly recommend that you use a tripod (etc.) to affix the microphone base at the same height as your ears would be when you are seated in your listening position. You can use the attached screw of a tripod (etc.) to fix the microphone base to the tripod (etc.).

11 Place the optimizer microphone to the ① position on the microphone base.

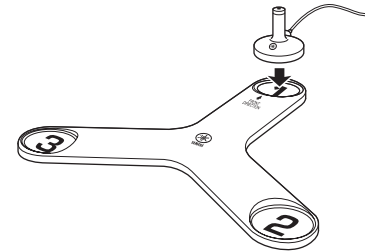

12 After the setting is completed, press **9**ENTER.

This unit starts the measurements of the speaker angles.

13 Repeat steps 11 and 12 for the ② and ③ positions on the microphone base.

The following display appears when measurement of the angle finishes successfully.

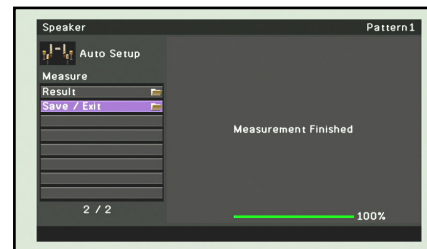

Result	Displays the results of automatic acoustics measurement. Refer to “Reviewing automatic setup parameters” (p. 48) for details.	
Save/Exit	SAVE	Applies the result to the speaker setup and finishes the automatic measurement. 🌟1
	CANCEL	Returns to the previous screen.
	EXIT	Finishes the automatic measurement without applying the result to the speaker setup.

- When the warning message appears on this display, refer to “When an error message is displayed during measurement” (p. 49) for details.
- Press **9**RETURN to return to the previous screen.

Continues to the next page

🌟1: The result of the measurement is assigned to the “Setting Pattern” currently selected. Refer “Setting Pattern” (p. 115) for details on “Setting Pattern.”



14 Press **9**Cursor Δ / ∇ to select “Save/Exit” and press **9**ENTER.



15 Press **9**Cursor \leftarrow / \rightarrow to select “SAVE” and press **9**ENTER.

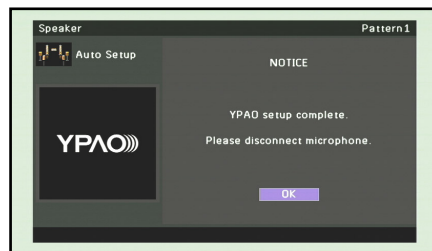

16 Press **9**ENTER.
Automatic setup is completed. Disconnect the YPAO microphone.

The YPAO microphone is sensitive to heat. When you have finished measuring, store the microphone out of direct sunlight, and away from locations that may experience high temperatures, such as on top of AV equipment.

Reviewing automatic setup parameters

The results of automatic acoustics measurement can be reviewed once measurement is complete.

1 Press **9**Cursor Δ / ∇ repeatedly to select “Result” and press **9**ENTER immediately after the automatic measurement.

The Result menu can be viewed only by performing the automatic measurement.

The results of acoustics measurement are displayed.

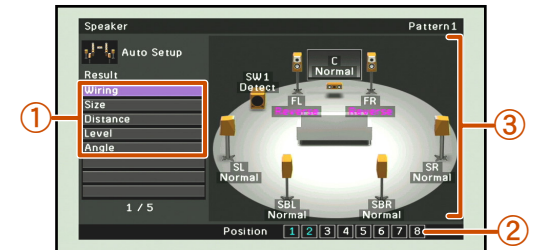

- ① **List of menu items**
Menu items available in the Result menu are displayed.
- ② **Number of measurement**
Indicates the number of measurements for multiple listening positions.
- ③ **Diagram**
Shows the speaker setup and sound adjustment as diagram.

Continues to the next page



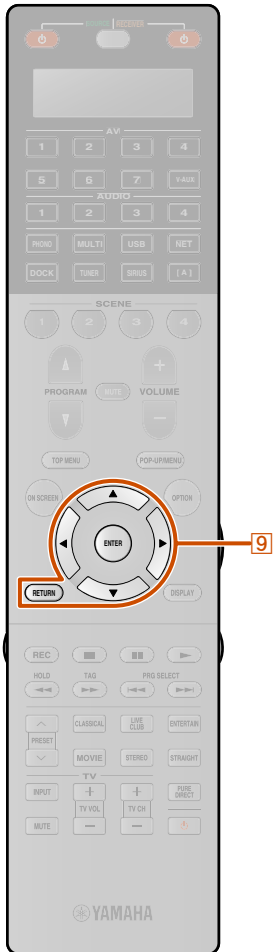

2 Select the desired menu item (or enable a function) using **[9]Cursor** Δ / ∇ / \leftarrow / \rightarrow and **[9]ENTER**.

Wiring	Displays the speakers connected to this unit and the polarity of each connected speaker. <ul style="list-style-type: none"> • “Normal” is displayed when the polarity of the connected speaker is normal. • “Reverse” is displayed when the polarity of the connected speaker is opposite.
Size	Displays the size of the connected speakers and the bass cross over frequency (“Bass Crossover”). <ul style="list-style-type: none"> • “Large” is displayed when the connected speaker has the ability to reproduce the low-frequency signals effectively. • “Small” is displayed when the connected speaker does not have the ability to reproduce the low-frequency signals effectively.
Distance	Displays the distance from the listening position to speakers. The unit for distance can be switched between “ft” (feet) and “m” (meter) by pressing [9]Cursor \leftarrow / \rightarrow .
Level	Displays the result of the adjustment of each connected speaker output level.

Angle	Displays the angles of the front speakers, surround speakers, front presence speakers and rear presence speakers at the measured point.
Setup Reload 	Clears the fine-adjustment with Manual Setup and reloads the result of automatic setup. For details, refer to “Reloading automatic setup parameters.”

3 Press **[9]RETURN** to finish the Result menu.

The result of automatic setup can be fine-tuned manually by “Manual Setup.” Refer to “Manual speaker setup” ([p. 115](#)) for details.

Reloading automatic setup parameters

If you are not satisfied with the fine-adjustment of setup parameters with Manual Setup, the result of automatic setup saved on this unit can be reloaded. Select “Setup Reload” in the Result menu.

NOTE

When automatic setup parameters are reloaded, manually configured settings are cleared. To avoid clearing manually configured settings by reloading automatic setup parameters, see “Prohibiting setting changes” ([p. 131](#)).

When an error message is displayed during measurement

See “Error messages” ([p. 51](#)) for instructions on resolving the problem and measure acoustics again.

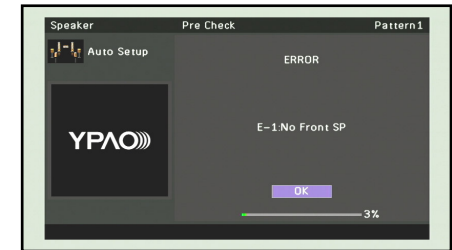

Check the error code displayed and use YPAO to measure acoustics again as described below.

When “E-1,” “E-2,” “E-3,” “E-4,” “E-6” or “E-11” is displayed:

- 1 Press **[9]ENTER**.
- 2 Press **[9]Cursor** \rightarrow to select “EXIT.”
- 3 Press **[9]ENTER** to terminate YPAO, and switch the unit to standby mode.
- 4 Check that the speakers are properly connected.
- 5 Turn on the unit and use YPAO again.

Continues to the next page

 **1**: This item is displayed after the fine-adjustment is performed with “Manual Setup.” Use this item to return the settings to the result of automatic setup.



When “E-7” or “E-8” is displayed:

- 1 Press **[9]ENTER**.
- 2 Check that the environment is suitable for accurate measurement.
- 3 Press **[9]Cursor >** to select “RETRY.”
- 4 Press **[9]ENTER** to use YPAO again.

When “E-5” or “E-9” is displayed:

- 1 Press **[9]ENTER**.
- 2 Check that the environment is suitable for accurate measurement.
- 3 Press **[9]Cursor </>** to select a option.
PROCEED:
 When “E-5” is displayed, measurement can proceed. However, the measurement in noisy environment may reduce the accuracy.
 When “E-9” is displayed, resume the aborted step.
RETRY:
 Restart measurement from the beginning.
- 4 Press **[9]ENTER** to execute the selected option.

When “E-10” is displayed:

- 1 Press **[9]ENTER**.
- 2 Press **[9]Cursor >** to select “EXIT.”
- 3 Press **[9]ENTER** to terminate YPAO, and switch the unit to standby mode.
- 4 Turn on the unit and use YPAO again.

When a warning message is displayed after measurement

See “Warning messages” (p. 51) for instructions on resolving the problem. The speaker causing the problem can be confirmed from the TV screen display.

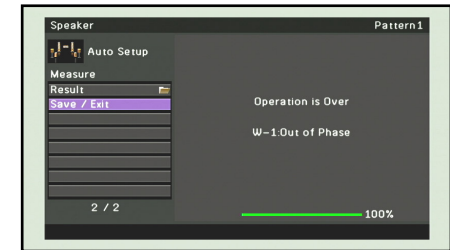

NOTE

Although the results of acoustics measurement can be applied when a warning message is displayed, optimal sound will not be achieved. Resolving the problem and using YPAO to measure acoustics again is recommended.

To exit YPAO with some options

- 1 Use **[9]Cursor Δ / ▽** to select “Save/Exit” and press **[9]ENTER**.
- 2 Use **[9]Cursor </>** to select one of the following options and press **[9]ENTER**.
SAVE:
 Exits YPAO applying the results of measurement.
CANCEL:
 Returns to the previous screen (warning message screen).
EXIT:
 Exits YPAO without saving the results.

Message list

NOTE

If the following messages appear, resolve the problems that have occurred and carry out the measurement process again.

When a warning message is displayed before measurement

Connect MIC!	The YPAO microphone is not connected.	Connect the YPAO microphone to the YPAO MIC jack on the front panel.
Unplug HP!	The headphones are connected.	Remove the headphones.
Memory Guard!	The settings of this unit are protected.	Set "Memory Guard" in the Setup menu to "Off" (see p. 131).

Error messages

E-1: No Front SP	The unit was not able to find the front channel.	Check that the left and right front speakers are connected correctly.
E-2: No Sur. SP	The unit was only able to find one of side of the surround channels.	Check that the left and right surround speakers are connected correctly.
E-3: No F.PRNS SP	The unit was only able to find one of side of the front presence channels.	Check that the left and right front presence speakers are connected correctly.
E-4: SBR→SBL	Only one surround back speaker is connected and only the right side surround back channel sound is detected.	When only one surround back speaker is connected, connect to the left side (SINGLE) terminal.
E-5: Noisy	The noise is too loud, preventing accurate measurements from being taken.	Measure again in quiet surroundings. Turn off any devices in the room that may be emitting noise, or place them further away from the YPAO microphone. When this message is displayed, selecting "PROCEED" will allow you to continue measuring. However, we recommend resolving the problem and measuring again, as continuing measurement without doing so will not give accurate results.
E-6: Check Sur.	Even though surround left and right speakers are not connected, only the surround back speakers are connected.	When using surround back speakers, connection of the surround left/right speakers is necessary.
E-7: No MIC	The YPAO microphone has been removed.	While measuring, take care not to touch the YPAO microphone.

E-8: No Signal	The YPAO microphone could not distinguish a test tone.	Check that the YPAO microphone has been installed correctly. Check that each speaker has been connected and installed correctly. The YPAO microphone or the YPAO MIC jack may be broken. Inquire at the retailer where you purchased this unit, or the nearest Yamaha service center.
E-9: User Cancel	You have carried out an operation that has cancelled the measuring process.	Carry out the measuring process again. Do not operate this unit by, for example, adjusting the volume.
E-10: Internal Error	An internal error has occurred.	Carry out the measuring process again. Contact a Yamaha service center if "E-10" is displayed again.
E-11: No R.PRNS SP	The unit was only able to find one of side of the rear presence channels.	Check that the left and right rear presence speakers are connected correctly.

Warning messages

W-1: Out of Phase	The speakers displayed are connected with the opposite polarity. Depending on the type of speakers you are using and the environment in which you have them installed, this message may occur even if the speakers are connected correctly.	Depending on the type of speakers, "W-1" may display even if the speakers are connected correctly. Check that the speaker polarity + (positive), and - (negative) are correct. If these are connected correctly, you can use the speakers normally even this message appears.
W-2: Over 24m/80ft	The speakers displayed are separated from the listening position by more than 24 m, and cannot be adjusted correctly.	Install the speakers with 24 m of the listening position.
W-3: Level Error	Volume level varies greatly for individual channels, and cannot be adjusted correctly.	Check that all speakers are installed in the same surroundings. Check that the speaker polarity + (positive), and - (negative) are correct. We recommend the same speakers or speakers with as similar specifications as possible. Adjust the volume of the subwoofer.

If "W-2" or "W-3" appears, you can apply measurement results, but they will not give optimal results. We recommend that you resolve the problem and carry out the measurement process again.



PLAYBACK

Basic playback procedure

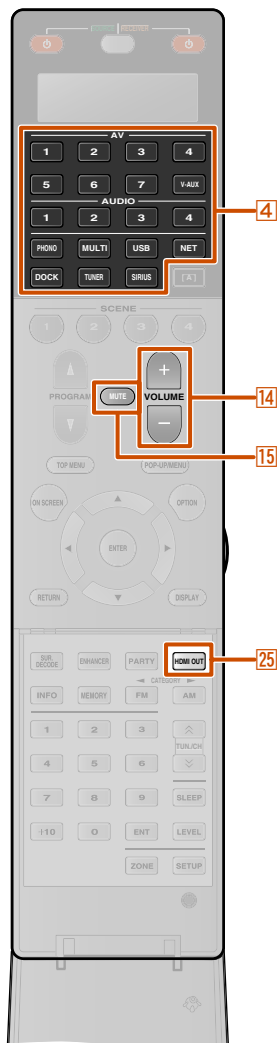

1 Turn on external components (TV, DVD player, etc.) connected to this unit.

2 Use the **[4] Input selector** to select the input source.

The name of the selected input source is displayed on the front panel display. 1

When USB, NET, DOCK, TUNER or SIRIUS is selected, the content window is displayed ([p. 66](#)).

3 Play the external component that you have selected as the source input, or select a radio station on the tuner.

Refer to the instruction manuals provided with the external component for details on playback.

For details on the following operations, refer to the corresponding pages:

- “FM/AM tuning” ([p. 67](#))
- “Listening to the HD Radio™” ([p. 70](#))
- “Listening to the SIRIUS Satellite Radio™” ([p. 74](#))
- “Playing back tunes on the PC” ([p. 80](#))
- “Playing back tunes on the USB storage devices” ([p. 82](#))
- “Listening to the Internet Radio” ([p. 84](#))
- “Using the Rhapsody® service” ([p. 86](#))
- “Listening to the SIRIUS Internet Radio” ([p. 90](#))
- “Playing back tunes from your iPod™/iPhone™” ([p. 94](#))
- “Playing back tunes from Bluetooth™ components” ([p. 98](#))

4 Press **[4] VOLUME +/-** to adjust the volume.

To mute the output.

Press **[15] MUTE** to mute the audio output.

Press **[15] MUTE** again to unmute.

Selecting the active HDMI OUT jack

Use this function to select the HDMI OUT jack(s) used to output signal.

Press **[25] HDMI OUT** repeatedly to select setting.

The HDMI output setting changes as follows.



OUT 1+2	Outputs the signal at both the HDMI OUT 1 and HDMI OUT 2 jacks simultaneously.
OUT 1	Outputs the signals at the HDMI OUT 1 jack.
OUT 2	Outputs the signals at the HDMI OUT 2 jack.
Off	Any signals are not output at the HDMI OUT 1 and HDMI OUT 2 jacks. Select this setting when you do not use the video monitor connected to one of the HDMI OUT jacks.

- The HDMI OUT jack that utilizes the HDMI Control function can be selected with “Control Select” ([p. 123](#)).
- When “HDMI Control” is set to “On,” the HDMI OUT jack selected with “Control Select” is automatically enabled in addition to the HDMI OUT jack selected here by commands from the external component supporting HDMI Control connected to the jack ([p. 123](#)).
- The active HDMI OUT jack(s) can be registered with the SCENE function ([p. 106](#)).

1 : You can change the input source name displayed on the front panel display as necessary ([p. 103](#)).

■ Adjusting high/low-frequency sound (Tone control)

You can adjust the balance of the high-frequency range (Treble) and low-frequency range (Bass) of sounds output from the front left and right speakers to obtain desired tone.

The tone control of the speakers or headphones can be set separately. Set the headphone tone control with the headphones connected.

1 Press TONE/BALANCE on the front panel repeatedly to select “Treble” or “Bass.”

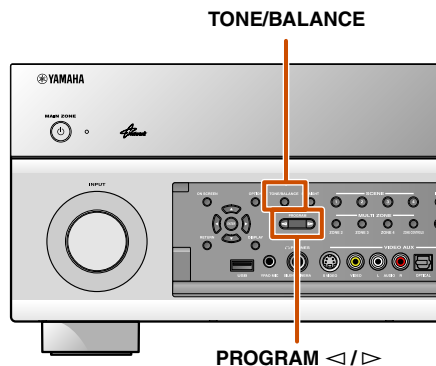

The current setting is displayed on the front panel display.



2 Press PROGRAM </> to adjust the output level in the following frequency range.

Adjustable range	-6.0 dB to +6.0 dB
Adjustment increments	0.5 dB

The display returns to the previous display soon after you release the key.

- The tone control settings are not effective when this unit is in the Pure Direct Mode or “MULTI CH” is selected as an input source.
- If you set the balance extremely off, sounds may not match those from other channels well.
- The tone control can also be adjusted in the Option menu ([p. 64](#)).

Changing input settings with a single key (SCENE function)

This unit has a SCENE function that allows you switch this unit on and change input sources, the settings of Audio Select, HDMI Output, Sound Program, Pure Direct Mode, Tone Control, Adaptive DRC, and Compressed Music Enhancer with one key.

Selecting the SCENE suitable for the external component

At initial factory settings, SCENE functions are configured for the following components. Select a scene according to the component that you want to play back.

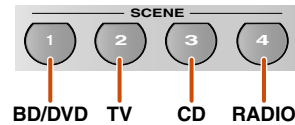

SCENE 1

Settings are configured for viewing DVD or Blu-ray Disc content. Press this key and play back content from the DVD or Blu-ray Disc player connected to the AV1 jack on this unit.

SCENE 2

The settings are configured for viewing a TV content. Press this key and turn on the TV connected to the AUDIO1 jack on this unit.

SCENE 3

Four scenes are available for different uses, such as playing movies or music. The following settings such as input sources, sound programs, and HDMI Output are provided at initial factory settings. Settings that are not checked () are not enabled when a scene key is pressed. Use “Load” in the Scene menu to check settings to be enabled. Refer to “Adjusting settings registered with the SCENE function” ([p. 107](#)) for details.

SCENE	Input	Audio Select	HDMI Output	Sound Program	Pure Direct Mode	Tone Control	Adaptive DRC	Compressed Music Enhancer	CINEMA DSP 3D Mode	Dialogue Lift	Extended Surround	Video Adjustment	Video Processing	Master Volume	Lipsync	Delay	Setting Pattern	PEQ Select
1 (BD/DVD Movie Viewing)	AV1	Auto	OUT 1+2	Drama	Auto	Bass: 0.0 dB Treble: 0.0 dB	On	Off	On	0	Auto	Off	Off	-40.0 dB	Auto	0 ms	Pattern1	Natural
2 (TV Viewing)	AUDIO1	Auto	OUT 1+2	STRAIGHT	Auto	Bass: 0.0 dB Treble: 0.0 dB	On	On	On	0	Auto	Off	Off	-40.0 dB	Auto	0 ms	Pattern1	Natural
3 (CD Music Listening)	AUDIO2	Auto	OUT 1+2	STRAIGHT	Auto	Bass: 0.0 dB Treble: 0.0 dB	Off	Off	On	0	Auto	Off	Off	-40.0 dB	Auto	0 ms	Pattern1	Natural
4 (Radio Listening)	TUNER	---	OUT 1+2	STRAIGHT	Auto	Bass: 0.0 dB Treble: 0.0 dB	Off	On	On	0	Auto	Off	Off	-40.0 dB	Auto	0 ms	Pattern1	Natural

The settings are configured for listening to CD content. Press this key and play back the CD player connected to the AUDIO2 jack on this unit.

SCENE 4

Settings are configured for listening to a radio station. Press this key and tune into a radio station.

SCENE 5-12

The nothing is registered on the scenes at initial factory setting. The favorite settings can be registered on the scenes and reloaded by using “Save” and “Load” in Scene menu. For details, refer to “Scene menu” ([p. 107](#)).

- When switching scenes, also change the external component that the remote control operates ([p. 134](#)).
- We recommend that selecting a scene and editing the SCENE function are performed in the Scene menu ([p. 106](#)).
- This unit has eight additional scene functions. After selecting one of these scenes, one of the additional eight scenes may also be selected ([p. 107](#)).
- Press and hold **[5]SCENE** key for about three seconds to register the current setting to the scene.



Enjoying favorite sound field effect

This unit is also equipped with a Yamaha digital sound field processing (DSP) chip. Multi-channel playback from almost any audio source can be enjoyed using a variety of sound decoders and various sound field effect programs stored on the chip. Sound field effect programs built into this unit are called “sound programs.”

Selecting sound programs and sound decoders

This unit offers sound programs in many different categories suitable for movies, music and other uses. Choose a sound program that sounds best with the source you are playing back, rather than relying on the name or explanation of the program.

Sound programs are stored for each input source. When you change the input source, the sound program previously selected for that input source is applied again.

Selecting sound program (p. 58):

CLASSICAL category: Press **20** **CLASSICAL** repeatedly 🌟1

LIVE/CLUB category: Press **20** **LIVE/CLUB** repeatedly 🌟1

ENTERTAIN category: Press **20** **ENTERTAIN** repeatedly 🌟1

MOVIE category: Press **20** **MOVIE** repeatedly 🌟1

Selecting stereo reproduction (p. 57):

Press **20** **STEREO** repeatedly 🌟1

Selecting surround decoder:

Press **21** **SUR. DECODE** repeatedly 🌟1

Turning on Straight decoding mode (p. 56):

Press **20** **STRAIGHT**

Turning on Pure Direct Mode (p. 57):

Press **20** **PURE DIRECT**

Turning on Compressed Music Enhancer (p. 57):

Press **21** **ENHANCER** repeatedly

Sound program categories



- You can use the speaker indicators on the front panel display to check what speakers are currently outputting sound (p. 11).
- You can adjust sound field elements (sound field parameters) for each of the programs (p. 109).

Enjoying surround sound with the CINEMA DSP function

Enjoying sound programs without surround speakers

This unit allows you to use virtual surround speakers to enjoy sound field surround effects, even without any surround speakers (Virtual CINEMA DSP mode). You can even enjoy surround sound presence with just a minimal configuration of the front speakers only. This unit will switch to Virtual CINEMA DSP mode automatically when Surround is set to “None” in Configuration (p. 117). 🌟2

Enjoying sound programs with headphones

Even when headphones are connected, you can enjoy the reproduction sound field presence with ease (SILENT CINEMA mode). 🌟3

🌟1 : A sound program, stereo reproduction option or sound decoder can also be selected by pressing **6** **PROGRAM** **Δ** / **∇**.

🌟2 : However, Virtual CINEMA DSP mode is not available under the following conditions:

- When headphones are connected to this unit.
- When a “7ch Stereo” or “2ch Stereo” sound program is selected.
- When Pure Direct Mode or straight decoding mode is selected.

🌟3 : However, SILENT CINEMA mode is not available under the following conditions:

- When a “2ch Stereo” sound program is selected.
- When Pure Direct Mode or straight decoding mode is selected.



Enjoying more spatial sound fields (CINEMA DSP 3D mode)

CINEMA DSP 3D mode creates an intensive and accurate stereoscopic sound field in the listening room. Connection of presence speakers is recommended to take full advantage of the effects of CINEMA DSP 3D mode. Do the following steps.  1

- Connect the front presence speakers to the EXTRA SP1 jacks and set the speakers to use. For more spatial sounds, connect the rear presence speakers to the EXTRA SP2 jacks and set the speakers to use (p. 20).
- Enable CINEMA DSP 3D in the Option menu (p. 62).

When a sound program runs in CINEMA DSP 3D mode, the CINEMA DSP 3D indicator on the front panel lights up.



Lights up

Enjoying sound programs without presence speakers

This unit allows you to use virtual presence speakers to create an intensive and accurate stereoscopic sound field, even when no presence speakers are connected (Virtual CINEMA DSP 3D mode). You can even enjoy surround sound presence with front speakers, center speaker, and surround speakers.

This unit automatically switches to Virtual CINEMA DSP 3D mode when presence speakers are not available. Do the following steps.

- At minimum, connect the front speakers, center speaker, and surround speakers.
- Enable the center speaker and surround speakers in “Configuration” (p. 117).
- Enable CINEMA DSP 3D in the Option menu (p. 64).

Enjoying unprocessed playback (Straight decoding mode)

Use straight decoding mode when you want to playback sound without sound field processing. You can playback as follows in straight decoding mode.

2-channel sources such as CD

Stereo sound plays through the front left and right speakers.

Multi-channel playback sources such as BD/DVD

Plays back audio from a playback source without applying sound field effects, using an appropriate decoder to split the signal into multiple channels.

Press **20** STRAIGHT to enable the straight decoding mode.



To disable straight decoding mode, press **20** STRAIGHT again.



Previously selected program

 1: However, CINEMA DSP 3D mode is not available under the following conditions:

- When headphones are connected to this unit.
- When a “7ch Stereo” or “2ch Stereo” sound program is selected.
- When Pure Direct Mode or straight decoding mode is selected.

Enjoying Hi-Fi Sound Quality (Pure Direct Mode)

Use Pure Direct Mode to enjoy the pure high fidelity sound of the selected source. When Pure Direct Mode is enabled, this unit plays back the selected source with the least circuitry. 

Press **[20] PURE DIRECT** to turn Pure Direct Mode on. 

To disable Pure Direct Mode, press **[20] PURE DIRECT** again.

Enjoying stereo playback

Select “2ch Stereo” from the sound programs when you want to playback 2-channel stereo sound (from the front speakers only), regardless of the playback source. Selecting “2ch Stereo” will playback as follows for the playback of CD and BD/DVD sources.

2-channel sources such as CD

Stereo sound plays back through the front speakers.

Multi-channel sources such as BD/DVD

Playback channels other than the front channels in the playback source are mixed with the front channels and played back through the front speakers.

Press **[20] STEREO** repeatedly to select “2ch Stereo.”



To disable stereo playback, press any of the **[20] Sound selection keys** to select a sound program other than “2ch Stereo.”

Enjoying compressed music source with better sound quality (Compressed Music Enhancer)

Compressed Music Enhancer improves the sound quality of the compressed music source closer to its original depth and width. 

This mode can be used along with any other DSP modes.

Press **[21] ENHANCER** to turn Compressed Music Enhancer on.



Lights up when the Compressed Music Enhancer is active

To disable Compressed Music Enhancer, press **[21] ENHANCER** again.



 **1** : The following features are disabled in Pure Direct Mode.

- sound program, tone control, PEQ Select, and Adaptive DRC
- displaying and operating the Option menu and ON SCREEN menu

 **2** : While Pure Direct Mode is on, the front panel display screen turns off in order to reduce noise. When turning Pure Direct Mode off, the screen returns on.

 **3** : However, Compressed Music Enhancer is not available in the following audio:







- Signals of which sampling rate is over 48kHz
- High Definition stream

Sound programs

 in the table indicates the sound program for CINEMA DSP.





Category: CLASSICAL

This sound field is suitable when listening to music sources such as CDs.

Hall in Munich 	This sound field simulates a concert hall with approximately 2500 seats in Munich, using stylish wood for the interior finishing as normal standards for European concert halls. Fine, beautiful reverberations spread richly, creating a calming atmosphere. The listener's virtual seat is at the center left of the arena.
Hall in Vienna 	This is an approximately 1700-seat, middle-sized concert hall with a shoebox shape that is traditional in Vienna. Pillars and ornate carvings create extremely complex reflections from all around the audience, producing a very full, rich sound.
Hall in Amsterdam 	The large, shoe box shaped hall seats about 2200 around the circle stage. Reflections are rich and pleasing while the sound travels freely.
Church in Freiburg 	Located in the south of Germany, this grand, stone-built church has a pointed tower at 120 meters in height. Its long and narrow shape and the high ceiling enable the elongated reverberation time and limited initial reflection time. Thus, the rich reverberation rather than the sound itself reproduces the atmosphere of the church.
Church in Royaumont 	This program features the sound field created by the refectory (dining hall) of a beautiful medieval Gothic monastery located in Royaumont on the outskirts of Paris.
Chamber 	This program creates a relatively wide space with a high ceiling like an audience hall in a palace. It offers pleasant reverberations that are suitable for courtly music and chamber music.





Category: LIVE/CLUB

This sound field is suitable when listening to music sources such as CDs.

Village Vanguard 	The Jazz club is on 7th Avenue, New York. This small club with the low ceiling makes the powerful reflections converge toward the stage located in the center.
Warehouse Loft 	The warehouse resembles some lofts in Soho. Sound reflects off the concrete walls clearly with a lot of energy.
Cellar Club 	This program simulates a live house with a low ceiling and homey atmosphere. A realistic, live sound field features powerful sound as if the listener is in a row in front of a small stage.
The Roxy Theatre 	This is the sound field of a rock music live house in Los Angeles, with approximately 460 seats. The listener's virtual seat is at the center left of the hall.
The Bottom Line 	This is the sound field at stage front in The Bottom Line, a famous New York jazz club once. The floor can seat 300 people to the left and right in a sound field offering real and vibrant sound.







Category: ENTERTAINMENT

Sound programs are optimized for video sources such as TV programs and games.

Sports 	This program allows the listeners to enjoy stereo sport broadcasts and studio variety programs with enriched live feeling. In sports broadcasts, the voices of the commentator and sportscaster are positioned clearly at the center while the atmosphere of the stadium expands in an optimal space to offer the listeners a feeling of presence in the stadium.
Action Game 	This sound field is suitable for action games such as car racing, fighting games and FPS games. The reality of, and emphasis on, various effects makes the player feel like they are right in the middle of the action, allowing for greater concentration. Use this program in combination with Compressed Music Enhancer for a more dynamic and strong sound field.
Roleplaying Game 	This sound field is suitable for role-playing and adventure games. This program adds depth to the sound field for natural and realistic reproduction of background music, special effects and dialog from a wide variety of scenes. Use this program in combination with Compressed Music Enhancer for a more clear and spatial sound field.
Music Video 	This sound field offers an image of a concert hall for live performance of pop, rock and jazz music. The listener can indulge oneself in a hot live space thanks to the presence sound field that emphasizes the vividness of vocals and solo play and the beat of rhythm instruments, and to the surround sound field that reproduces the space of a big live hall.
Recital/Opera 	This program controls the amount of reverberations at an optimum level and emphasizes the depth and clarity of human voices. "Recital/Opera" offers the reverberations of an orchestra box in front the listener at the same time as providing the acoustic positioning and feeling of presence on the stage. The surround sound field is relatively moderate, but the data for concert hall effects are used to represent the inherent beauty of music. The listener will not be fatigued even after long hours of opera entertainment.

Category: MOVIE

Sound programs optimized for viewing video sources such as movies.

Standard 	This program creates a sound field emphasizing the surround feeling without disturbing the original acoustic positioning of multi-channel audio such as Dolby Digital and DTS. It has been designed with the concept of an ideal movie theater, in which the audience is surrounded by beautiful reverberations from the left, right and rear.
Spectacle 	This program represents the spectacular feeling of large-scale movie productions. It reproduces a broad theater sound field that matches cinemascope and wider-screen movies with an excellent dynamic range providing everything from very small sound effects to large, impressive sounds.
Sci-Fi 	This program clearly reproduces the finely elaborated sound design of the latest science fiction and special effects-featuring movies. You can enjoy a variety of cinematographically created virtual spaces reproduced with clear separation between dialogue, sound effects and background music.
Adventure 	This program is ideal for precisely reproducing the sound design of action and adventure movies. The sound field restrains reverberations but puts emphasis on reproducing a powerful space expanded widely to the left and right. The reproduced depth is also restrained relatively to ensure the separation between audio channels and the clarity of the sound.
Drama 	This sound field features stable reverberations that match a wide range of movie genres from serious dramas to musicals and comedies. The reverberations are modest but offer an optimum 3D feeling, reproducing effects tones and background music softly but cubically around clear words and center positioning in a way that does not fatigue the listener even after long hours of viewing.
Mono Movie 	This program is provided for reproducing monaural video sources such as a classic movie in an atmosphere of a good old movie theater. The program produces the optimum expansion and reverberation to the original audio to create a comfortable space with a certain sound depth.







Category: STEREO

Sound programs are optimized for listening to stereo sources.

2ch Stereo	Use this program to mix down multi-channel sources to 2-channels. When multi-channel signals are input, they are down mixed to 2-channels and output from the front left and right speakers.
7ch Stereo 	Use this program to output sound from all speakers. When you playback multi-channel sources, this unit down-mixes the source to 2-channels, and then outputs the sound from all speakers. This program creates a larger sound field and is ideal for background music at parties, etc.

Category: SUR.DECODE (Surround decode mode)

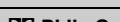
Select this program to playback sources with selected decoders. You can playback 2-channel audio sources in up to 7-channels using a surround decoder.

 Pro Logic	Reproduces sound using the Dolby Pro Logic decoder. This is suitable for all kinds of audio sources.
 PLIIX Movie /  PLII Movie	Reproduces sound using the Dolby Pro Logic IIx (or Dolby Pro Logic II) decoder. This is suitable for movies. 🌟1
 PLIIX Music /  PLII Music	Reproduces sound using the Dolby Pro Logic IIx (or Dolby Pro Logic II) decoder. This is suitable for music. 🌟1
 PLIIX Game /  PLII Game	Reproduces sound using the Dolby Pro Logic IIx (or Dolby Pro Logic II) decoder. This is suitable for games. 🌟1
Neo:6 Cinema	Reproduces sound using the DTS Neo:6 decoder. This is suitable for movies.
Neo:6 Music	Reproduces sound using the DTS Neo:6 decoder. This is suitable for music.

🌟 1 : You cannot select the Dolby Pro Logic IIx decoder in the following conditions:

- When "Surround Back" is set to "None" (see p. 117).
- When headphones are connected.

Using the TV display to control this unit

This unit features a sophisticated on-screen display (OSD) that helps you to control the amplifier function of this unit. With the OSD, you can view information of the signals being input and the status of this unit. Visual guidance simplifies operations for menus.

Basic operations via the TV screen display

A TV screen is required to display the ON SCREEN or Option menu. Refer to “Connecting a TV monitor” for instructions on connecting a TV screen ([p. 30](#)).

This section describes basic operations for configuring “Input,” “Scene” and “Sound Program” using the OSD.

Press **8** ON SCREEN.

The ON SCREEN menu is displayed on the TV screen.

Selecting an input source

1 Use **9** Cursor Δ / ∇ to select “Input” and press **9** ENTER.

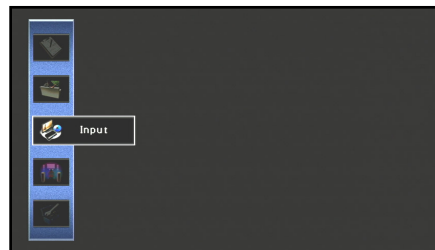

Input source icons are displayed at the bottom of the TV screen.

2 Use **9** Cursor $\triangleleft / \triangleright$ to select a Input source and press **9** ENTER.

The input source is selected.

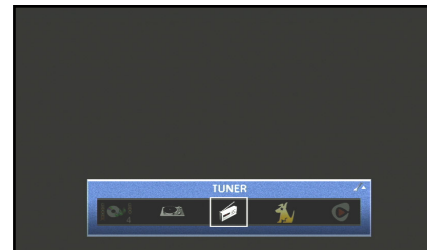

- Pressing **9** RETURN displays the previous menu screen. Press **9** RETURN repeatedly to close the ON SCREEN menu.
- In addition to selecting an input source, detailed settings for each input source can be configured. Refer to “Configuring input sources (Input menu)” ([p. 102](#)) for details.

Selecting a scene

1 Use **9** Cursor Δ / ∇ to select “Scene” and press **9** ENTER.

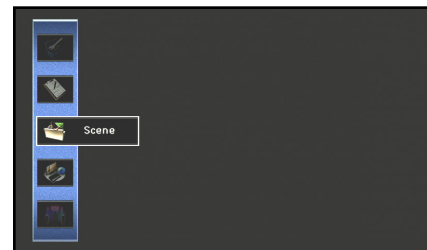

Scene icons are displayed at the bottom of the TV screen.

2 Use **9** Cursor $\triangleleft / \triangleright$ to select a scene and press **9** ENTER.

The scene is selected.



- Pressing **9** RETURN displays the previous menu screen. Press **9** RETURN repeatedly to close the ON SCREEN menu.
- Refer to “Changing input settings with a single key (SCENE function)” ([p. 54](#)) for details on the default scene settings.
- Detailed SCENE function settings can be edited. Refer to “Editing the SCENE function (Scene menu)” ([p. 106](#)) for details.

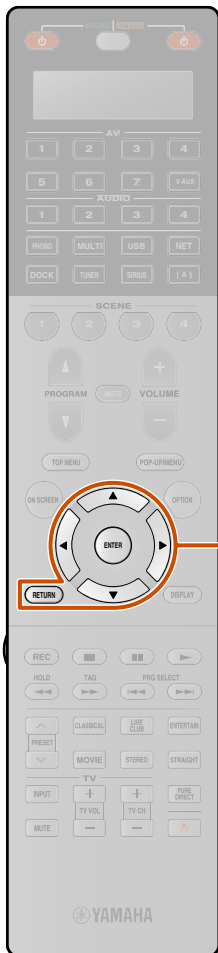

Selecting a sound program

- 1 Use **[ENTER]** **Cursor** Δ / ∇ to select “Sound Program” and press **[ENTER]**.

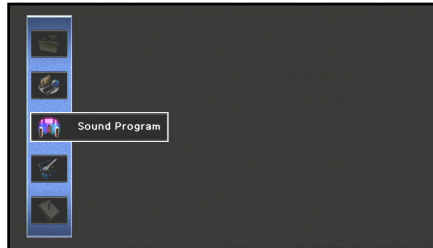

Sound program icons are displayed at the bottom of the TV screen.

- 2 Use **[ENTER]** **Cursor** \leftarrow / \rightarrow to select a sound program and press **[ENTER]**.

The sound program is selected.

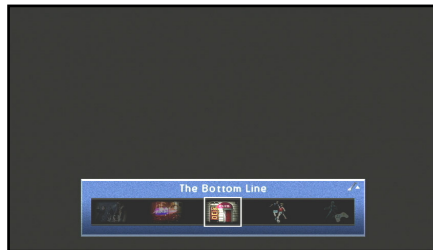

- Pressing **[RETURN]** displays the previous menu screen. Press **[RETURN]** repeatedly to close the ON SCREEN menu.
- Refer to “Enjoying favorite sound field effect” ([p. 55](#)) for various sound programs.
- You can configure the detailed settings for each sound program. Refer to “Setting sound program parameters (Sound Program menu)” ([p. 109](#)) for details.

NOTES

Menus can be operated and the status of this unit confirmed from the following three main displays.

- **ON SCREEN** menu ([p. 102](#))
- **Option** menu ([p. 62](#))
- **Content** window ([p. 66](#))

These menus and status features can be used to configure more various functions in addition to selecting “Input,” “Scene” and “Sound Program.” Refer to each references for details on menus and status.

Configuring settings specific to an individual input source (Option menu)

This unit has a unique Option menu for each input source. Option menus can be used to enable features such as volume trim for compatible input sources or to display audio/video data.

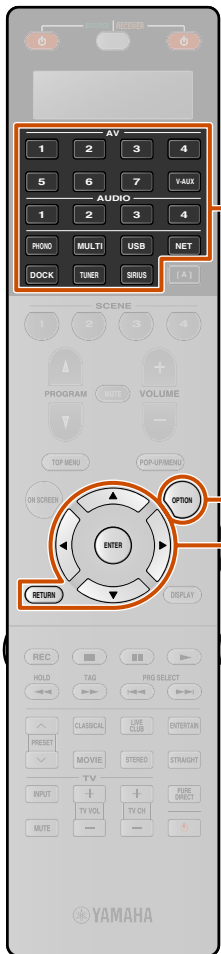

Option menu display and setup

Option menu operations are displayed on the front panel display or TV screen. TV display is used here to explain operation.

1 Use **[4]** Input selector to select an input source to which options will be applied.

2 Press **[16]** OPTION.
The Option menu is displayed.

Option menu

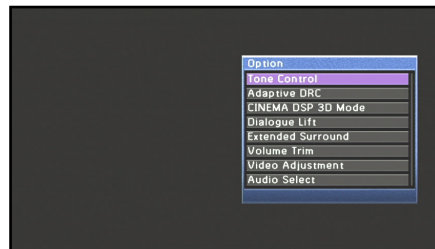

The displayed Option menu settings differ depending on the input source.

For more information, refer to the “Option menu” on the next page.

3 Use **[9]** Cursor Δ / ∇ to select the desired setting and press **[9]** ENTER.

Parameters of the selected item are displayed.

4 Use **[9]** Cursor \leftarrow / \rightarrow to select the desired item (or enable a function).

- Press **[9]** RETURN to display the previous screen or close the Option menu.
- The Option menu may close automatically when some functions are enabled.

5 Press **[16]** OPTION to close the Option menu.

The keys on the remote control may not respond for a few seconds after the Option menu is closed. Should this occur, select the input source again.

Option menu

The following items are provided for each input source. “✓” indicates the available menu for each input source. 🌟1

	AV1-4	AV5-7	V-AUX	AUDIO1-4	PHONO	MULTI CH	USB	PC	NET RADIO	Rhapsody	SIRIUS IR	DOCK (iPod)	DOCK (Bluetooth)	TUNER	SIRIUS
Tone Control	✓	✓	✓	✓	✓		✓	✓	✓	✓	✓	✓	✓	✓	✓
Adaptive DRC	✓	✓	✓	✓	✓		✓	✓	✓	✓	✓	✓	✓	✓	✓
CINEMA DSP 3D Mode	✓	✓	✓	✓	✓		✓	✓	✓	✓	✓	✓	✓	✓	✓
Dialogue Lift 🌟2	✓	✓	✓	✓	✓		✓	✓	✓	✓	✓	✓	✓	✓	✓
Extended Surround	✓	✓	✓	✓🌟3											
Volume Trim	✓	✓	✓	✓	✓	✓	✓	✓	✓	✓	✓	✓	✓	✓	✓
Video Adjustment	✓		✓	✓🌟4	✓🌟4										
Audio Select	✓		✓	✓🌟3	✓🌟3										
Shuffle							✓	✓		✓		✓🌟5			
Repeat							✓	✓		✓		✓🌟5			
Connect													✓		
Disconnect													✓		
Pairing													✓		

🌟1 : When “Tone Control,” “Adaptive DRC,” “CINEMA DSP 3D Mode,” “Dialogue Lift,” or “Extended Surround” is adjusted for an input source, the same value is applied to other input sources and “ALL” is displayed on the front panel display. When settings specific to a certain input source are selected, the input source name is displayed on the front panel display. If the name of the input source has been changed (p. 103), the original name of the

input source is displayed.

🌟2 : “Dialogue Lift” can be adjusted only when the presence speakers are available.

🌟3 : This function is only available when “Coax/Opt” is assigned to this input source from “Input Assignment” in the Setup menu. Refer to “Assigning component input and output jacks” (p. 129) for details.

🌟4 : This function can be set only when “Component” is assigned to this input source from “Input Assignment” in the Setup menu. Refer to “Assigning component input and output jacks” (p. 129) for details.

🌟5 : Not available for Yamaha Wireless System for iPod.



Adjusting high/low-frequency sound

Tone Control

You can adjust the balance of the high-frequency range (Treble) and low-frequency range (Bass) of sounds output from the front left and right speakers to obtain desired tone.

Adjustable range	-6.0 dB to +6.0 dB
Adjustment increments	0.5 dB

Auto-adjusting the sound level to make even low volumes more audible

Adaptive DRC

Adjusts the dynamic range in conjunction with the volume level (from minimum to maximum). When this item is set to “On,” dialogue and sound effects are clearer. 🌟1

Off (Default)	Does not adjust the dynamic range automatically.
On	Adjusts the dynamic range automatically.

When “On” is selected, the dynamic range is adjusted as follows.

If the volume level is low, the dynamic range is narrow.
If the volume level is high, the dynamic range is wide.

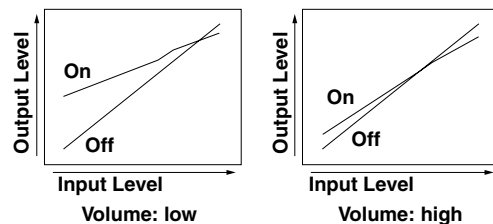

Enjoying more spatial sound fields

CINEMA DSP 3D Mode

When CINEMA DSP 3D is enabled, set whether to use sound programs in CINEMA DSP 3D mode (p. 56).

Adjusts the vertical position of dialogues

Dialogue Lift

Adjusts the vertical position of center sound such as dialogues when presence speakers are used. Increasing this parameter raises the position.

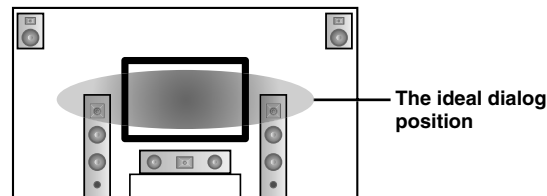

The ideal dialog position

If the dialog seems to come out from a lower position than the video monitor screen, increase this parameter.

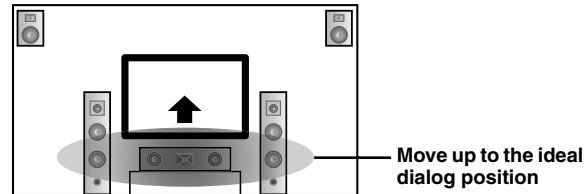

Move up to the ideal dialog position

“0” (default) corresponds to the lowest position and “5” to the highest position.

- “Dialogue Lift” can be adjusted only when the presence speakers are available.
- You cannot move the dialog position lower than the default setting.

Selecting the 5.1-channel signal playback method

Extended Surround

Selects whether to reproduce 5.1-channel input signals in 6.1- or 7.1-channel when surround back speakers are used. 🌟2

Auto (Default)	Automatically selects the most suitable decoder if a flag for reproducing surround back channel is present, and reproduces the signals in 6.1- or 7.1-channel.
<input checked="" type="checkbox"/> PLIIx Movie	Always reproduces signals in 7.1-channel using the Dolby Pro Logic IIx Movie decoder whether or not surround back channel signals are contained. You can select this parameter when two surround back speakers are connected.
<input checked="" type="checkbox"/> PLIIx Music	Always reproduces signals in 6.1- or 7.1-channel using the Dolby Pro Logic IIx Music decoder whether or not surround back channel signals are contained. You can select this parameter when one or two surround back speakers are connected.
EX/ES	Automatically selects the most suitable decoder for input signals whether or not the flag for reproducing surround back channel is present, and always reproduces signals in 6.1-channel.
Off	Always reproduces original channels whether or not the flag for reproducing surround back channel is present.

🌟1: “Adaptive DRC” is also effective when you use headphones.

🌟2: AV5-6 or AUDIO1-2 are available when “Audio Return Channel” is on, and the input source is used for “TV Audio Input.”

Adjusting volume between input sources

Volume Trim

Reduces any change in volume when switching between input sources by correcting volume differences in each input source. You can adjust this parameter for each input source.

Adjustable range	-6.0 dB to +6.0 dB
Default setting	0.0 dB
Adjustment increments	0.5 dB steps

Selecting a video adjustment preset

Video Adjustment

Selects the desired “Adjustment” (p. 122) preset to be applied to the selected input source.

Selecting audio input jacks



Audio Select



Select the audio input jack through which source signal is input when an input source is connected to more than one jack.

Auto (Default)	Automatically selects input signal in the following order: (1) HDMI (2) Digital signal (3) Analog signal
HDMI	Selects only HDMI signal. When no HDMI signal is input, no sound is output.
Coax/Opt	Selects only coaxial or optical signal. When no signal is input, no sound is output.
Analog	Selects only analog signal. If no analog signal is input, no sound is output.

Shuffle playback



Shuffle

Plays back songs or albums in random order. When the shuffle function is enabled, “” appears on the TV screen. 

Off	The shuffle function is turned off.
On 	The shuffle function is turned on.
Songs 	Plays songs back in random order.
Albums 	Plays albums back in random order.

Repeat playback

Repeat

Plays songs or albums repeatedly. When the repeat function is enabled, “ (Single / One[iPod])” or “ (All)” appears on the TV screen. 

Off	The repeat function is turned off.
Single / One[iPod]	Plays a song back repeatedly.
All	When all songs have completed playback, returns to the start and repeats playback.

Connect / Disconnect Bluetooth component

Connect

Disconnect

Switches communication with a Bluetooth component on and off (p. 98).

Pairing Bluetooth component

Pairing

Performs pairing of this unit and a Bluetooth component (p. 98).

 1: Not available for Yamaha Wireless System for iPod.

 2: This item is displayed only when PC, USB or Rhapsody is selected as input source.

 3: This item is displayed only when DOCK (iPod) is selected as input source.

Confirming and operating input sources from the content window

When USB, NET, DOCK, TUNER or SIRIUS is selected, the content window is displayed on the TV screen. Playback style for iPod, functions for FM/AM tuner, SIRIUS Satellite Radio, Rhapsody, SIRIUS Internet Radio, Internet Radio, PC, and USB can be set in the content window.

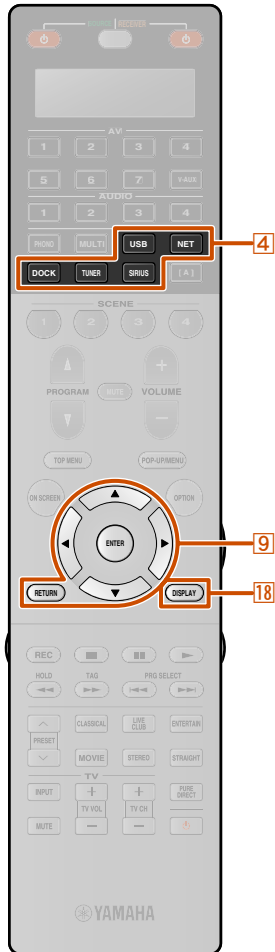

A TV screen is required to display the content window. Refer to “Connecting a TV monitor” for instructions on connecting a TV monitor (p. 30).

Displaying the content window on the TV screen

Press **4**USB, **4**NET, **4**DOCK, **4**TUNER or **4**SIRIUS to display the content window.

The content window consists of two main displays, the Now Playing view and the Browse view.

Below is the example of the Now Playing view for DOCK (iPod).

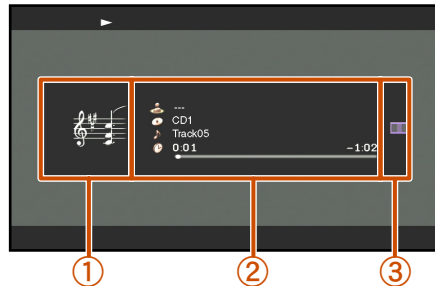

- ① **Image display**
Icon for each input source or album art is displayed.
- ② **Information display**
Information on the current input source is displayed.

③ Screen button area

Buttons to operate each input source are displayed here. These buttons vary depending on the selected input. For details on operations for each input, see the following.

- FM/AM stations (p. 68)
- HD Radio stations (p. 70)
- SIRIUS channels (p. 74)
- PC servers (p. 81)
- USB storage (p. 83)
- Internet Radio (p. 85)
- Rhapsody (p. 86)
- SIRIUS Internet Radio (p. 90)
- iPod (p. 95)

- In the Now Playing view, press **9**ENTER and use **9**Cursor Δ / ∇ to select a button. Then press **9**ENTER to execute the selection.
- In the Browse view, press **9**Cursor \triangleright and use **9**Cursor Δ / ∇ to select a button. Then press **9**ENTER to execute the selection.
- Press **9**RETURN repeatedly to exit from the operation.

Switching the display between the Now Playing view and the Browse view

You can switch the display between the Now Playing view and the Browse view by the following methods.

- Press **18**DISPLAY to cycle between the Now Playing view and the Browse view.
- In the Now Playing view, press **9**ENTER and use **9**Cursor Δ / ∇ to select the  icon. Then press **9**ENTER to switch to the Browse view.

- In the Browse view, press **9**Cursor \triangleright and use **9**Cursor Δ / ∇ to select the  icon. Then press **9**ENTER to switch to the Now Playing view.

Browse view

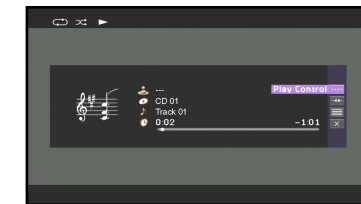

When selecting “DOCK (iPod)” as input source and playing back video content of iPod/iPhone, the screen switches as follows by pressing **18**DISPLAY repeatedly.

Now Playing view \rightarrow Browse view \rightarrow
 Video playback screen (content window disappears)
 \rightarrow Now Playing view

FM/AM tuning

When using the FM/AM tuner, adjust the direction of the FM/AM antenna connected to this unit to get the best reception.

Selecting a frequency for reception (Normal tuning)

- 1 Press **[4] TUNER** to switch to the tuner input.
- 2 Press **[26] FM** or **[26] AM** to select a band to receive.



- 3 Use **[26] TUN./CH** \wedge / \vee to set a frequency to receive.

[26] TUN./CH \wedge

Increases the frequency. Press and hold this key for longer than a second to search automatically for a station on a higher frequency than the current one. **💡1**

[26] TUN./CH \vee

Decreases the frequency. Press and hold this key for longer than a second to search automatically for a station on a lower frequency than the current one. **💡1**

Lights up when a broadcast is received from a station



Lights up when a stereo broadcast is received

Entering a frequency number

In normal tuning mode, use the **[23] Numeric keys** to enter a frequency. Leave the decimal point out when entering a number. **💡2**

For example, enter as follows to select a station on 98.5 MHz.



Registering stations manually (Manual Preset)

Select stations manually and register them as presets individually.

- 1 Tune in to the station you want to register, referring to "Selecting a frequency for reception (Normal tuning)." **💡3**

- 2 Use one of the following methods to register the station you are currently receiving.

Registering to a preset number to which no station is registered

Press **[26] MEMORY** for 3 seconds or longer.

The station will be registered automatically to the lowest open preset number (or the next number after the one registered most recently).

Registered frequencies



Continues to the next page

💡1 : When searching for a station, release the key once the search has started.

💡2 : "Wrong Station!" appears on the front panel display when you enter a frequency that is out of receivable range. Make sure that the frequency entered is correct.

💡3 : When registering a sub-audio program "HD2" to "HD8" of the FM HD Radio station, press **[19] PRG SELECT** to select the desired audio program.

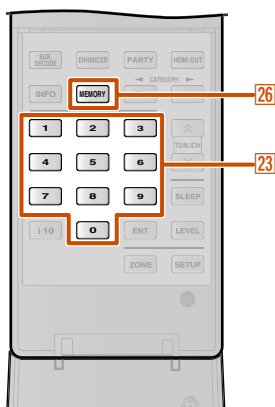
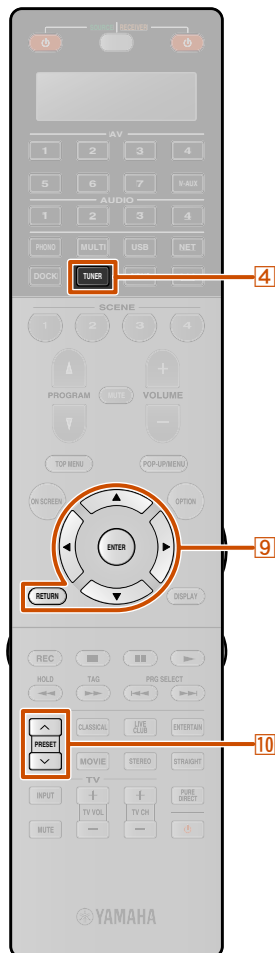

■ Designating a preset number for registration

Press **26**MEMORY once, to display “Manual Preset” on the front panel display. After a small wait, the preset number that the station has been registered to will appear. **💡1**

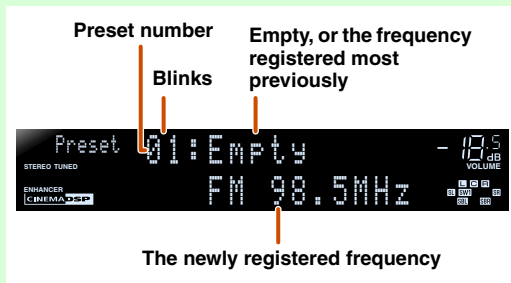

Press **10**PRESET ^ / v to select the preset number to register the station to, and then press **26**MEMORY to register.

To select a registered station, press **10**PRESET ^ / v to select the preset number of the station. **💡2**

Navigating the FM/AM tuner from the content window

The station currently received can be confirmed from the menu displayed on the TV screen. Various FM/AM tuner operations can be performed from the content window rather than controls on the front panel display. The content window is displayed when **4**TUNER is pressed. You can operate the FM/AM tuner from the Now Playing view or the Browse view.

■ Operating from the Now Playing view

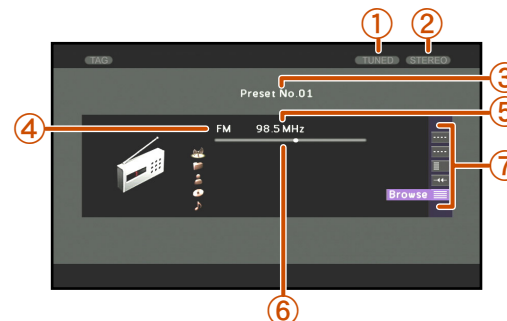

- 1 Tuned indicator**
Lights up when a station is received.
- 2 Stereo indicator**
Lights up when a stereo broadcast is received. When “Audio Mode” is set to “Mono,” the indicator does not light.
- 3 Preset number**
The selected preset number is displayed.
- 4 Band**
The selected band (FM or AM) is displayed.

- 5 Frequency**
The frequency currently received is displayed.
- 6 Frequency guide**
The frequency currently received is displayed as a cursor on the bar.
- 7 Screen button area**
Buttons for available operations are displayed. See “Screen buttons on the Now Playing view” for details.

Screen buttons on the Now Playing view

To use these buttons, first press **9**ENTER. Then select the desired one with **9**Cursor Δ / ▽ and **9**ENTER.

Manual Tuning

You can tune in to a desired FM/AM station by specifying its frequency.

FM	Switches a band to FM.
AM	Switches a band to AM.
Tuning -	Decreases the frequency.
Tuning +	Increases the frequency.
Auto -	Automatically searches for a station on a lower frequency than the current station.
Auto +	Automatically searches for a station on a higher frequency than the current station.
Direct	Selects the frequency manually.
Memory	Registers the station currently received as a preset station. Up to 40 FM/AM stations can be registered.

💡1 : Press **9**RETURN or wait with no operation for 30 seconds to exit the Manual Preset mode.

💡2 : To select a station by selecting a preset number, use the **23**Numeric keys to enter the preset number of the station you want to listen. When an invalid number is entered, “Wrong Num.” appears on the front panel display. Check that you have entered the correct number.

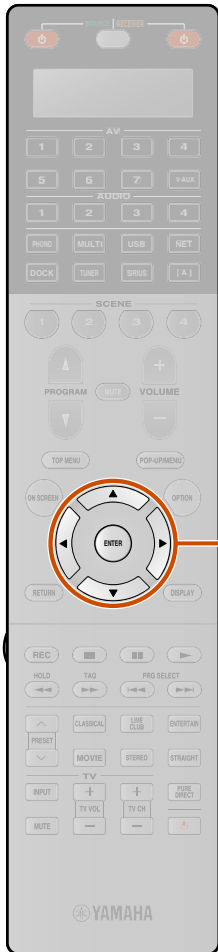

Preset Select

You can call preset stations.

Preset -	Selects the previous preset number.
Preset +	Selects the next preset number.
Preset -8	Returns the previous page.
Preset +8	Goes to the next page.
Memory	Registers the station currently received as a preset station. Up to 40 FM/AM stations can be registered.
Direct	Selects a station directly by entering the preset number.

Utility

Audio Mode	Selects "Auto" or "Mono" when receiving the FM station (see p. 67).
------------	---

Scroll

Switches the scroll target.

Browse

Switches the display to the Browse view.

Operating from the Browse view

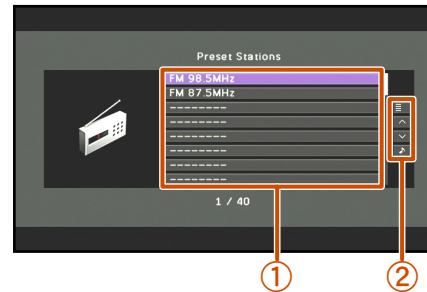

- ① **Preset station list**
The list of preset stations is displayed.
- ② **Screen button area**
Buttons for available operations are displayed. See "Screen buttons on the Browse view" for details.

Screen buttons on the Browse view

To use these buttons, first press [9]Cursor ▷. Then select the desired one with [9]Cursor △ / ▽ and [9]ENTER.

Utility

Auto Preset	Detects FM stations with a strong signal and automatically registers up to 40 FM stations, beginning with the next number after the current number (see p. 69). AM stations cannot be registered by using "Auto Preset."
Clear Preset	Clears registration of the preset station highlighted in the preset station list.
Clear All Preset	Clears registration of all preset stations.

1 Page Up

1 Page Down

Scrolls the list to the next or previous page.

Now Playing

Switches the display to the Now Playing view.

Listening to the HD Radio™

HD Radio technology is a new technology that enables FM and AM radio stations to broadcast programs digitally. Digital broadcasting provides listeners with radically improved audio quality and reception as well as new data services. Furthermore, supplemental program services allow listeners to select from up to 8 HD Radio programs multicast on a single FM HD Radio channel. For further information on HD Radio technology, visit “http://www.ibiquity.com/”.

This unit is equipped with an HD Radio reception feature, facilitating CD quality FM broadcasts as well as analog FM stereo quality AM broadcasts. In addition, this unit can receive both audio and data (such as song titles, artist names, program types, and comments) from all HD Radio programs (HD1 to HD8).

- The tuning method for HD Radio stations are same as analog FM/AM radio stations; however, you only tune into the analog part of a hybrid HD Radio station while this unit is in the monaural tuning mode (see p. 73).
- This unit is capable of receiving both hybrid and all-digital HD Radio station signals. However, this unit may not automatically receive all-digital FM station signals and the automatic tuning operation may stop. In this case, enter the frequency of the desired all-digital FM HD Radio station directly by using **[23] Numeric keys** (see p. 67).

Selecting HD Radio™ audio programs

The HD indicator lights up in the front panel display when this unit is tuned into an HD Radio station. In this state, you can select the desired audio program if the selected FM HD Radio station provides multiple audio programs (up to 8).

When multiple audio programs are provided

Lights up when a broadcast is received from a HD Radio station



Audio program number (absolute)

Press **[19] PRG SELECT** **◀◀ / ▶▶** repeatedly to select the desired audio programs.

Audio programs can also be selected using **[23] Numeric keys** (1-8) and **[23] ENT** when this unit is in the automatic or manual tuning mode. When the selected audio program is not available currently, “HDx Off” (“x” indicates the program number) appears.

- When reception for an audio program ceases, the HD indicator disappears from the front panel display and HD1 is automatically selected after approximately 20 seconds.
- Some audio programs may not contain data programs depending on the broadcasting station and the time period.

When only one audio program is provided

If this unit is tuned into an FM HD Radio station including only one audio program or an AM HD Radio station, you cannot select audio programs.

Lights up when a broadcast is received from a HD Radio station



Audio program number (absolute)



Audio program number (relative/total)

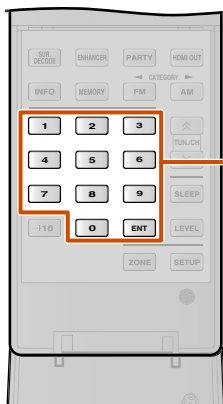



Using the iTunes Tagging

This unit is equipped with the iTunes Tagging that enables HD Radio listeners to “tag” songs for subsequent preview and purchase on iTunes. For details on the iTunes Tagging, visit “<http://www.ibiquity.com/>”.

1 Tune into an HD Radio station and select HD Radio audio program (if available).

If the selected HD Radio program (or song being played) supports the iTunes Tagging, the TAG indicator lights up on the front panel display.

Lights up



2 While a song you want to tag is being played back, press TAG.

If a song is tagged, “StorageSuccess” and the number of stored iTunes Tagging information files (up to 50) appear in the front panel display.

- “Insufficient Data” is displayed on the front panel display if tagging is not possible.
- If a status or error message is displayed on the front panel, see “iTunes Tagging” (p. 160).

This unit transmits the “tag” data to the iPod/iPhone if an iPod/iPhone that supports iTunes Tagging is placed in the Universal Dock for iPod (YDS-12, sold separately) connected to the DOCK terminal of this unit. Otherwise, this unit stores the “tag” data (up to 50) in the internal memory and will transmit it next time your iPod/iPhone is placed in the dock.

Displaying the HD Radio™ information

You can display the HD Radio information on the front panel display. 1

Press INFO repeatedly to toggle the HD Radio information display modes as shown below.

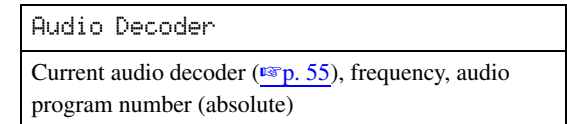
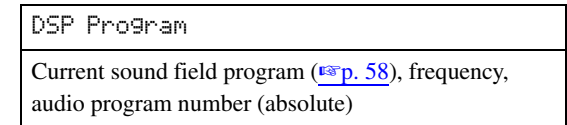
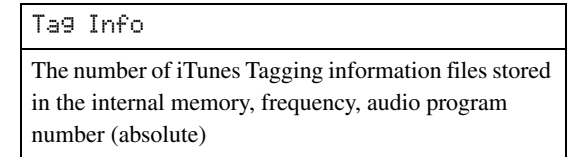
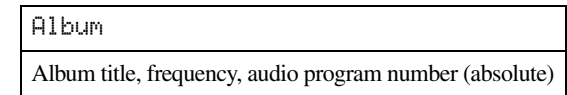
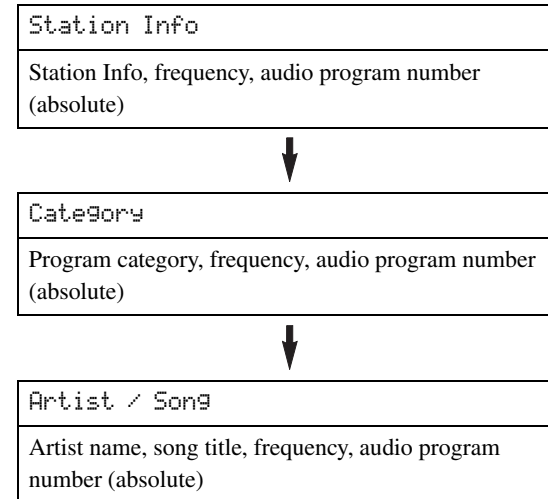

Back to “Station Info”

Display example (DSP Program)



1: If the HD Radio information contains a character that cannot be recognized by this unit, the character will be displayed with a space. When an information is unavailable, “—” appears.

Navigating the HD Radio™ tuner from the content window

A HD Radio station currently received can be confirmed from the menu displayed on the TV screen. Various HD Radio operations can be performed from the content window rather than controls on the front panel display. The content window is displayed when **4** **TUNER** is pressed.

The HD Radio tuner can be operated from the Now Playing view or the Browse view.

Operating from the Now Playing view

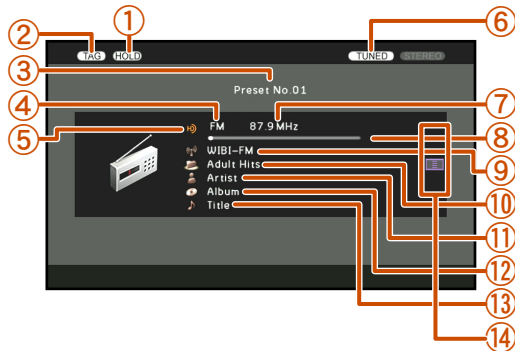

- ① **HOLD indicator**
Lights up when **19** **HOLD** is pressed to activate the hold function. The artist name and song title currently received will remain displayed. Press **19** **HOLD** again to cancel the hold function.
- ② **TAG indicator**
Lights up when the selected station supports the iTunes Tagging.
- ③ **Preset number**
The selected preset number is displayed.
- ④ **Band**
The selected band (FM or AM) is displayed.
- ⑤ **HD Radio indicator**
Lights up when receiving the HD Radio station.
- ⑥ **Tuned indicator**
Lights up when a station is received.
- ⑦ **Frequency**
The frequency currently received is displayed.
- ⑧ **Frequency guide**
The frequency currently received is displayed as a cursor on the bar.
- ⑨ **Channel Name**
The channel name currently received is displayed.
- ⑩ **Channel Category**
The category of the channel is displayed.
- ⑪ **Artist Name**
The artist name of the current song is displayed.
- ⑫ **Song Title**
The title of the current song is displayed.
- ⑬ **Album Name**
The album name of the current song is displayed.
- ⑭ **Screen button area**
Buttons for available operations are displayed. See “Screen buttons on the Now Playing view” for details.

Screen buttons on the Now Playing view

To use these buttons, first press **9** **ENTER**. Then select the desired one with **9** **Cursor** Δ / ∇ and **9** **ENTER**.

Manual Tuning

You can tune in to a desired FM/AM station by specifying its frequency.

FM	Switches a band to FM.
AM	Switches a band to AM.
Tuning -	Decreases the frequency.
Tuning +	Increases the frequency.
Auto -	Automatically searches for a station on a lower frequency than the current station.
Auto +	Automatically searches for a station on a higher frequency than the current station.
Direct	Selects the frequency manually.
Memory	Registers the station currently received as a preset station. Up to 40 FM/AM stations can be registered.
Program -	Select the previous program of the HD Radio.
Program +	Select the next program of the HD Radio.
Hold	Activates the hold function. The artist name and song title currently received will remain displayed.
Tag	Applies the iTunes Tagging.



Preset Select

You can call preset stations registered.

Preset -	Selects the previous preset number.
Preset +	Selects the next preset number.
Preset -8	Returns the previous page.
Preset +8	Goes to the next page.
Direct	Selects a station directly by entering the preset number.
Memory	Registers the station currently received as a preset station. Up to 40 FM/AM stations can be registered.
Hold	Activates the hold function. The artist name and song title currently received will remain displayed.
Tag	Applies the iTunes Tagging.

Utility

Audio Mode	Selects "Auto" or "Mono" when receiving the FM (or HD Radio) station (p. 70).
Auto	Stereo reception. HD Radio program is received by priority.
Mono	Monaural reception. Reception is better in monaural mode. HD Radio program is not received.

Scroll

Switches the scroll target (channel name, channel category, artist name, song name, or album name).

Browse

Switches the display to the Browse view.

Operating from the Browse view

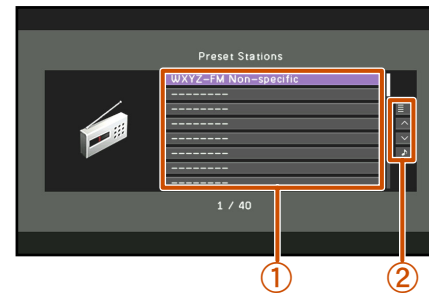

- Preset station list**
The list of preset stations is displayed.
- Screen button area**
Buttons for available operations are displayed. See "Screen buttons on the Browse view" for details.

Screen buttons on the Browse view

To use these buttons, first press **[9]Cursor ▷**. Then select the desired one with **[9]Cursor △ / ▽** and **[9]ENTER**.

Utility

Auto Preset	Detect HD FM, HD AM or analog FM stations with a strong signal and automatically registers up to 40 stations, beginning with the next number after the current number (p. 73). Analog AM stations cannot be registered by using "Auto preset."
Clear Preset	Clears registration of the preset station highlighted in the preset station list.
Clear All Preset	Clears registration for all preset stations.

1 Page Up

1 Page Down

Scrolls the list to the next or previous page.

Now Playing

Switches the display to the Now Playing view.



Listening to the SIRIUS Satellite Radio™

To listen to Satellite Radio, you'll need to connect a SIRIUS Satellite Radio tuner (sold separately) to your Sirius-Ready receiver. SIRIUS Satellite Radio is available to residents of the US (except Alaska and Hawaii) and Canada.

Satellite Radio delivers a variety of commercial-free music from categories ranging from Pop, Rock, Country, R&B, Dance, Jazz, Classical and many more plus coverage of all the top professional and college sports including play by play games from select leagues and teams. Additional programming includes expert sports talk, uncensored entertainment, comedy, family programming, local traffic and weather and news from your most trusted sources.

Once you've purchased a SIRIUS tuner you'll need to activate it and subscribe to begin enjoying the service. Easy to follow installation and setup instructions are provided with the SIRIUS tuner. There are a variety of programming packages available, including the option of adding "The Best of XM" programming to the SIRIUS service. The "Best of XM" service is not available to SIRIUS Canada subscribers at this time. Please check with SIRIUS Canada for any updates using the numbers and web address below.

Family friendly packages are also available to restrict channels featuring content that may be inappropriate for children.

To subscribe to SIRIUS, U.S. and Canadian customers can call 1-888-539-SIRI (1-888-539-7474) or visit sirius.com (US) or siriuscanada.ca (Canada).

SIRIUS Radio Legal

SIRIUS and all related marks and logos are trademarks of Sirius XM Radio Inc. and its subsidiaries. All other marks and logos are the property of their respective owners. All rights reserved. SIRIUS subscription sold separately. Taxes and a one-time activation fee may apply. SIRIUS tuner required (sold separately) to receive the SIRIUS service. All programming and fees subject to change. It is prohibited to copy, decompile, disassemble, reverse engineer, hack, manipulate or otherwise make available any technology or software incorporated in receivers compatible with the SIRIUS Satellite Radio System. Service not available in Alaska or Hawaii.

Connecting the SiriusConnect™ tuner

Connect the SiriusConnect tuner (sold separately) to the SIRIUS jack on the rear panel of this unit. For details, see the instruction manuals provided with the SiriusConnect tuner.

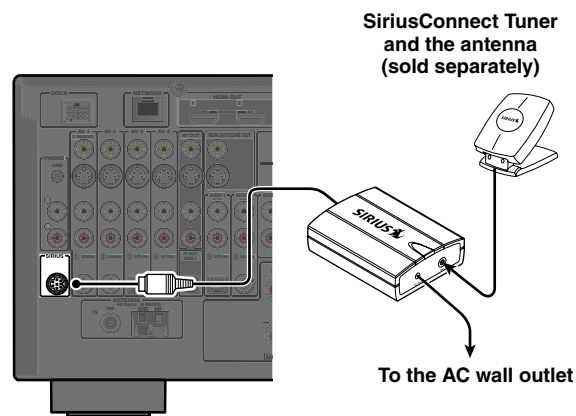

- To ensure optimal reception of the SIRIUS Satellite Radio signals, the antenna of the SiriusConnect tuner must be placed at or near a window with no obstacles in the path to the sky. The orientation of the antenna for the best reception differs depending on the area. Refer to the instruction manuals provided with the SiriusConnect tuner for the installation of the antenna. You can mount it indoors or outdoors.
- Use the Antenna information on the front panel display or the SIRIUS information screen on the TV screen ([esp. p. 78](#)) to check the antenna reception level and adjust the orientation of the antenna.
- You need to connect the SiriusConnect tuner to the AC wall outlet.

NOTES

- If "CHECK SR TUNER" or "ANTENNA ERROR" appears on the front panel display, the connection of the SiriusConnect tuner or antenna is incorrect. In such cases, check the connection of the SiriusConnect tuner and the antenna.
- If "NOT SUPPORTED" appears on the front panel display, this unit does not support the connected SiriusConnect tuner.

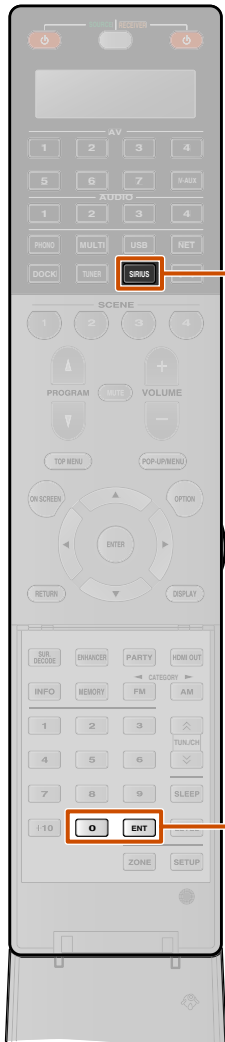

Activating SIRIUS Satellite Radio™ subscription

Before using the SIRIUS Satellite Radio feature, you need to activate your SIRIUS Satellite Radio subscription. To activate the subscription you need the Sirius ID which is uniquely assigned to the SiriusConnect tuner. Sirius ID is 12-digit number which is indicated on the package of the SiriusConnect tuner and on the label of the SiriusConnect tuner. Sirius ID is also configured on the front panel display when you tune into the SIRIUS Satellite Radio channel “0.”

■ Displaying the Sirius ID of your SiriusConnect tuner

1 Press **[4] SIRIUS**.

2 Press **[23] 0** and then **[23] ENT** to display the Sirius ID of your SiriusConnect tuner.

“000 Sirius ID” and “xxxxxxxxxxxx” (“xxxxxxxxxxxx” indicates the 12-digit Sirius ID of your SiriusConnect tuner) appears alternately on the front panel display.

Write down the Sirius ID in the space provided below.

ID: _____

3 Contact SIRIUS Satellite Radio to activate your subscription.

SIRIUS Satellite Radio online information

Contact for activation

URL: <https://activate.siriusradio.com/>

Phone: 1-888-539-SIRIUS (1-888-539-7474)

Status messages appear on the front panel display and the TV screen during the activation. For details, see “SIRIUS Satellite Radio™” (p. 160). Once the activation is finished, “SUB UPDATED” appears.

SIRIUS Satellite Radio™ operations

1 Press **[4] SIRIUS** to select “SIRIUS” as the input source.

The SIRIUS Satellite Radio information (such as channel number, channel name, category, artist name, or song title) for the currently selected channel appears on the front panel display. 📶1



NOTES

- Before activating your subscription, you can only select “184” or “000.”
- If a status message or an error message appears on the front panel display or TV screen, refer to “SIRIUS Satellite Radio™” (p. 160).

2 Search for a channel by using one of the SIRIUS Satellite Radio search modes.

All channel search mode

Selects a channel from the all channel list (p. 76).

Category search mode

Selects a channel by category (p. 76).

Direct number access mode

Selects a channel directly by entering the channel number (p. 76).

Preset search mode

Selects a channel from the preset channels (p. 77). You can preset channels by registering them to specific numbers, and later just select those numbers to tune in.

- SIRIUS Satellite Radio information can be displayed on the front panel display and the TV screen (p. 78).
- If you tune into a channel that you do not subscribe, “CALL SIRIUS on the front panel display” or “CALL 888-539-SIRIUS TO SUBSCRIBE” appears on the TV screen.

📶1 : When you select “SIRIUS” as the input source, this unit automatically calls the previously selected channel.



All channel search mode

Press **26**TUN./CH **▲** / **▼** repeatedly to search for a channel within all channels.

All channel search mode



- You can search for a channel quickly by pressing and holding **26**TUN./CH **▲** / **▼**.
- You can skip channels to the previous or next category by pressing **26**CATEGORY **<** / **>**.

Category search mode

1 Press **26**CATEGORY **<** / **>** to select the channel category.

When you select the category, the first channel in the category is selected.

Category search mode Category name



The first channel in the category

If you don't operate within 10 seconds, the category search mode returns to "ALL (All Channel Search)."

2 While "Category" is displayed on the front panel display, press **26**TUN./CH **▲** / **▼** repeatedly to search for a channel within the selected channel category.

You can search for a channel quickly by pressing and holding **26**TUN./CH **▲** / **▼**.

NOTE

This unit skips the following channels in all channel search mode or category search mode. This is not a malfunction.

- channels that are locked (see p. 78)
- channels that are not currently in service
- channels that you do not subscribe to

Direct number access mode

Press the **23**Numeric keys to enter the desired three-digit channel number.

For example, to enter the number 123, press "1," "2" and then "3" of the **23**Numeric keys.

- When entering a one-digit or two-digit channel number, enter the number using the **23**Numeric keys and then press **23**ENT to confirm your entry.
- This unit automatically accepts your entry if you do not press **23**ENT within a few seconds after entering the number.
- If the selected channel is locked, "PIN: ___" appears on the front panel display. Enter the 4-digit Parental Lock code number by using the **23**Numeric keys or press **23**ENT to cancel (see p. 78).
- If the selected channel is not available, an advisory message may appear. For details, refer to "SIRIUS Satellite Radio™" (see p. 160).
- If this unit is in preset search mode, a preset number is selected instead of a channel number when you press the **23**Numeric keys. To switch to direct number access mode, press **26**TUN./CH **▲** / **▼**.

Registering and recalling the SIRIUS Satellite Radio™ channels

Up to 40 SIRIUS Satellite Radio channels can be registered as preset channels.

Registering preset channels

1 Search for a channel to be registered.

For details on searching channels, refer to the following pages.

- All channel search mode (see p. 76)
- Category search mode (see p. 76)
- Direct number access mode (see p. 76)

2 Use one of the following methods to register the channel currently received.

Registering to a preset number for which no channel has been registered

Press and hold **26**MEMORY for at least 2 second. The channel will be automatically registered to the lowest available preset number (or the next number after the last to which a channel was registered).

Preset number Registered channel



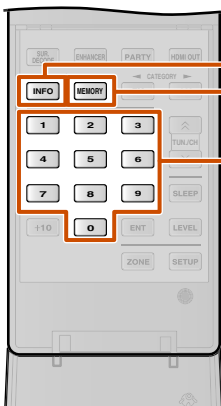

■ Designating a preset number for registration

Press **[26]MEMORY** once.

Preset number (Blinks) Previously registered channel (or "----" if no channel has been registered)



Channel to be registered

Press **[10]PRESET** \wedge / \vee to select the preset number to which the channel will be registered and then press **[26]MEMORY** to register.

To cancel registration, press **[9]RETURN** or do not operate the remote control for about 30 seconds.

■ Recalling a preset channel (Preset Search mode)

Specify preset numbers to recall registered channels.

Preset number



Press **[10]PRESET** \wedge / \vee to change the preset numbers (1 to 40).

- Preset numbers to which no channel has been registered are skipped.
- Preset numbers can also be selected by pressing **[23]Numeric keys**.

1 : If the SIRIUS Satellite Radio information contains a character that cannot be recognized by this unit, the character will be displayed with a space. When an information is unavailable, "----" appears.

Displaying the SIRIUS Satellite Radio™ information

You can display the SIRIUS Satellite Radio information on the front panel display. **1**

NOTE

If a status message or an error message appears on the front panel display or TV screen, see "SIRIUS Satellite Radio™" (p. 160).

■ Front panel display

Press **[22]INFO** repeatedly to toggle the SIRIUS Satellite Radio information display modes as shown below.

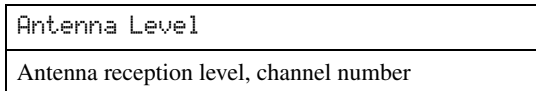
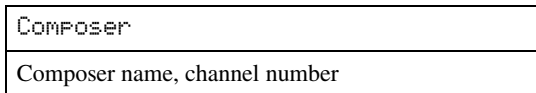
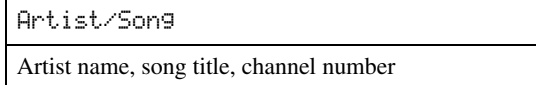

Signal reception level

Search mode Channel number



Signal reception level

Signal reception is shown in four levels.

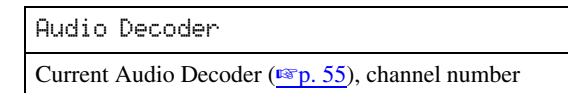
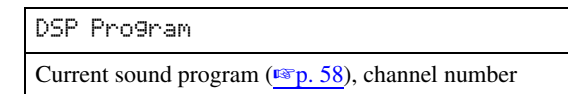

Back to "Artist/Song"



Navigating the SIRIUS Satellite Radio™ tuner from the content window

The SIRIUS Satellite Radio channel currently received can be confirmed from the menu displayed on the TV screen. Various SIRIUS Satellite Radio operations can be performed from the content window rather than controls on the front panel display. The content window is displayed when **[4] SIRIUS** is pressed. The SIRIUS Satellite Radio tuner can be operated from the Now Playing view or the Browse view.

Operating from the Now Playing view

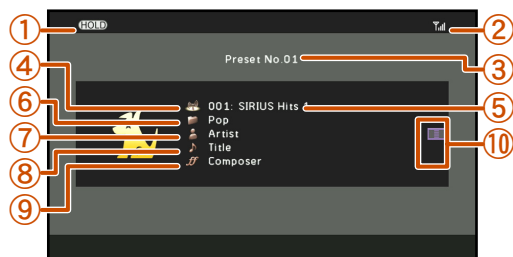

- ① **HOLD indicator**
Lights up when **[19] HOLD** is pressed to activate the hold function. The artist name and song title currently received will remain displayed. Press **[19] HOLD** again to cancel the hold function.
- ② **Signal reception level**
Indicates the signal reception level.

Weak signal ← Strong signal
- ③ **Preset number**
The selected preset number is displayed.

- ④ **Channel number**
The channel number currently received is displayed.
- ⑤ **Channel Name**
The channel name currently received is displayed.
- ⑥ **Channel Category**
The category of the channel is displayed.
- ⑦ **Artist Name**
The artist name of the current song is displayed.
- ⑧ **Song Title**
The title of the current song is displayed.
- ⑨ **Composer Name**
The composer name of the current song is displayed.
- ⑩ **Screen button area**
Buttons for available operations are displayed. See “Screen buttons on the Now Playing view” for details.

Screen buttons on the Now Playing view

To use these buttons, first press **[9] ENTER**. Then select the desired one with **[9] Cursor Δ / ▽** and **[9] ENTER**.

Radio Control

Select a channel for reception.

Preset -	Select the previous preset number.
Preset +	Select the next preset number.
CAT -	Select the previous category.
CAT +	Select the next category.
CH -	Scan channels downwards from the current channel.
CH +	Scan channels upwards from the current channel.
Memory	Register the current channel as a preset number. Up to 40 channels can be registered.
Direct	Specify a specific channel by manually entering the channel number.
Hold	Activates the hold function. The artist name and song title currently received will remain displayed.

Utility

Parental Lock	Restricts the access to specified channel.
---------------	--

When the parental lock function is enabled for a particular channel, that channel is skipped in all channel search mode and category search mode.

- 1 Use **[9] Cursor < / >** to select a number, and press **[9] ENTER** to enter the selected number.

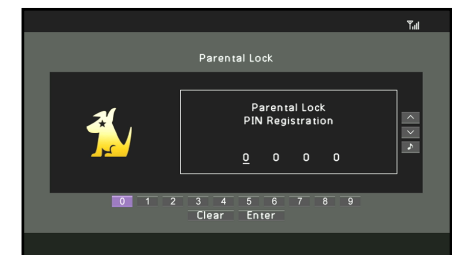

- 2 Repeat step 1 to enter the desired 4-digit code number.
- 3 Use **[9] Cursor ▽** to select “Enter,” and press **[9] ENTER** to confirm the 4-digit code number.
Selecting “Clear” and pressing **[9] ENTER** clears all the code entered.
- 4 Use **[9] Cursor Δ / ▽** to select the category and press **[9] ENTER**.

Continues to the next page



5 Use **9**Cursor Δ / ∇ to select the channel to be locked and press **9**ENTER.

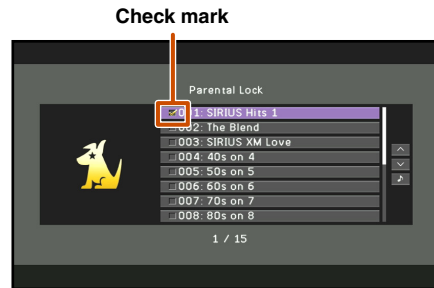

When **9**ENTER is pressed, the selected channel is received for confirmation. Each time **9**ENTER is pressed after that, lock switches between on and off.

To lock channels in other categories, press **9**RETURN to display the category selection screen, and follow the procedure described above.

NOTES

- If a code number is already registered and the different code number is entered, “Wrong Number” appears. Use **9**Cursor Δ / ∇ to select Parental Lock and press **9**ENTER, and then enter the correct number.
- If you forget the parental lock code or want to change it, reset it using “SR PIN” (see p. 146).

Receiving locked channels

Use direct number access mode (see p. 76) or preset search mode (see p. 77) to receive locked channels. When a locked channel is received, “Locked” is displayed followed by the parental lock code input screen. Use **23**Numeric keys to enter the 4-digit code.

Scroll

Switches the scroll target (channel name, channel category, artist name, song title, or composer name).

Browse

Switches the display to the Browse view.

Operating from the Browse view

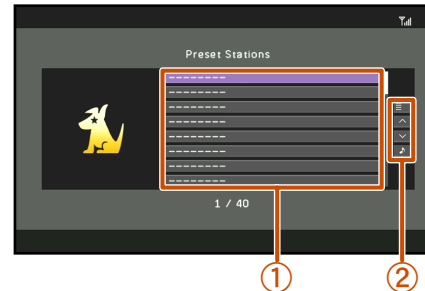

① Preset station list

The list of preset stations is displayed.

② Screen button area

Buttons for available operations are displayed. See “Screen buttons on the Browse view” for details.

Screen buttons on the Browse view

To use these buttons, first press **9**Cursor \triangleright . Then select the desired one with **9**Cursor Δ / ∇ and **9**ENTER.

Utility

Parental Lock	Restricts the access to specified channel (see p. 78).
Clear Preset	Clears registration of the preset station highlighted in the preset station list.
Clear All Preset	Clears registration of all preset stations.

1 Page Up

1 Page Down

Scrolls the list to the next or previous page.

Now Playing

Switches the display to the Now Playing view.



Playing back tunes on the PC

You can enjoy playback of audio files stored on PCs connected to this unit via your network. To play back audio files on your PC, you need to install Windows Media Player on the PC and configure the media sharing setting of Windows Media Player.

If you do not use a DHCP server, configure the network parameters (IP address, etc.) of this unit manually ([p. 125](#)).

Windows Media Player setup

1 Install Windows Media Player on your PC.

You can download the installer of Windows Media Player from the Microsoft website, or use the upgrade function of the installed Microsoft Windows Media Player.

2 Turn on your PC then allow media sharing.

Activate Windows Media Player first, enable the media sharing and then select this unit as a device to which the media is shared.

NOTES

- Some security software installed on your PC (anti-virus software, firewall software, etc.) may block the access of this unit to your PC. In such cases, configure the security software appropriately.
- You can connect this unit to up to 16 PC servers, and each server must be connected to the same subnet as this unit.

Playback of PC music contents

For a complete list of status messages that appear on the front panel display and GUI screen, see “USB and Network” ([p. 161](#)).

The PC music contents can be operated from the menu displayed on the TV screen.

You can operate the PC contents from the Now Playing view or the Browse view.

Operating from the Browse view

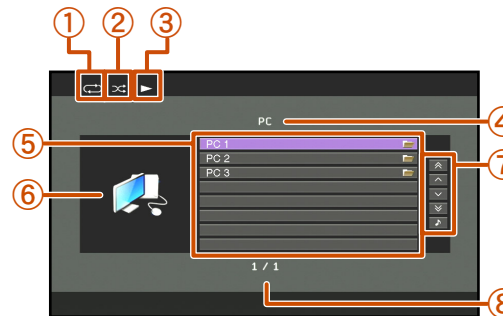

- 1 Repeat icon
- 2 Shuffle icon
- 3 Play icon
- 4 Current directory name
- 5 Menu items
- 6 Album art / Input icon
- 7 Screen button area
Buttons for available operations are displayed. See “Screen buttons on the Browse view” for details.
- 8 Current menu number / Number of all menu items

Screen buttons on the Browse view

To use these buttons, first press **[9]Cursor ▷**. Then select the desired one with **[9]Cursor △ / ▽** and **[9]ENTER**.

10 Pages Up

10 Pages Down

Goes to 10 pages forwards or backwards.

1 Page Up

1 Page Down

Scrolls the list to the next or previous page.

Now Playing

Switches the display to the Now Playing view.

1 Press **[4]NET** repeatedly to select “PC” as the input source.

2 Press **[9]Cursor △ / ▽** to select a PC server and music file to play back.

- To select a PC server, folder or file, press **[9]Cursor △ / ▽**.
- To confirm the selection, press **[9]ENTER**.
- To return to the previous menu, press **[9]RETURN**.

3 Press **[9]ENTER** to start playback.
The Now Playing view appears during playback.



Operating from the Now Playing view

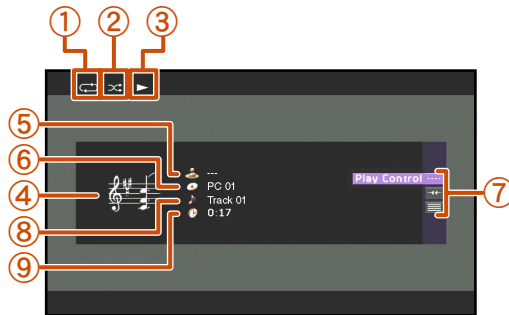

- ① Repeat icon
- ② Shuffle icon
- ③ Play icon
- ④ Album image
- ⑤ Artist name
- ⑥ Album title
- ⑦ Screen button area
- ⑧ Song title
- ⑨ Elapsed time

- You can switch the information displayed on the front panel display by pressing **[22]INFO** (see p. 11).
- Album images are available only when the file contains image data.

Screen buttons on the Now Playing view

To use these buttons, first press **[9]ENTER**. Then select the desired one with **[9]Cursor Δ / ▽** and **[9]ENTER**.



Play Control

Operates the basic playback functions of PC.

	(Play)	Starts playback.
	(Stop)	Stops playback.
	(Pause)	Stops playback temporarily.
	(Skip -)	Skips to the beginning of the currently playing song. Press [9]ENTER at the beginning of the song to skip to a previous song.
	(Skip +)	Skips to the beginning of the next song.

Scroll

Switches the scroll target (artist name, album title, or song title).

Browse

Switches the display to the Browse view.

Compatibility of Digital Media Controller

A DLNA-compliant Digital Media Controller (DMC) device can also be used to control music playback. Refer to “Using a PC to control this unit over a network” (see p. 104) for details.

CAUTION

When DMC controls are used to adjust volume, playback volume may be unexpectedly loud. This could result in damage to this unit or the speakers. “Max Volume” can be used to specify the maximum volume level to prevent excessively loud playback (see p. 120).

Operating basic playback functions with the remote control

Use the following remote control keys to operate (playback, stop, skip, etc.) your PC contents.

	Play
	Stop
	Switches between playback and pause.
	Skip forward during playback
	Skip backward during playback

Shuffle/repeat playback

Use the Option menu to apply playback shuffle and repeat settings. Refer to “Shuffle playback” (see p. 65) and “Repeat playback” (see p. 65) for details.

- 1: A shortcut button cannot be registered when a DMC is used.
- 2: Set “DMC Control” to “Disable” to automatically play back the last song played when this unit is turned on.

Playing back tunes on the USB storage devices

You can enjoy playback of WAV (PCM format only), MP3, WMA, MPEG-4 AAC and FLAC files stored on your USB memory device or USB portable player connected to the USB port on the front panel of this unit. This unit supports USB mass storage class devices (FAT 16 or FAT 32 format, except USB HDDs).

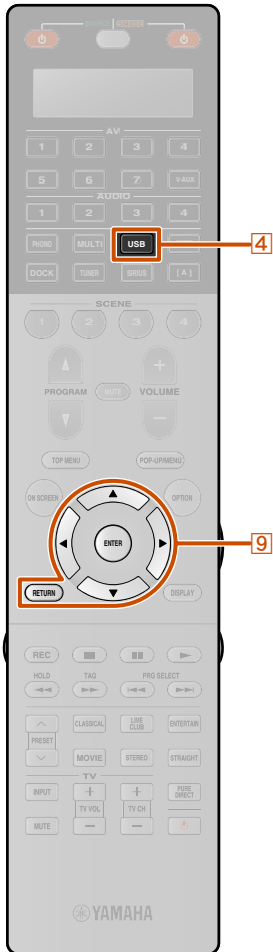

- You can play back only the files stored in the first partition.
- Some files may not be playable depending on models and types of USB storage devices.
- For a complete list of status messages that appear on the front panel display and GUI screen, see “USB and Network” (p. 161).
- This unit is compatible with sampling frequency of up to 48 kHz for the USB storage device.

Playback of the USB storage device

The USB storage device can be operated from the menu displayed on the TV screen.

You can operate the contents of USB storage device from the Now Playing view or the Browse view.

Operating from the Browse view

If you have connected the USB storage device to this unit before, playback of the music file played at the last time automatically starts.

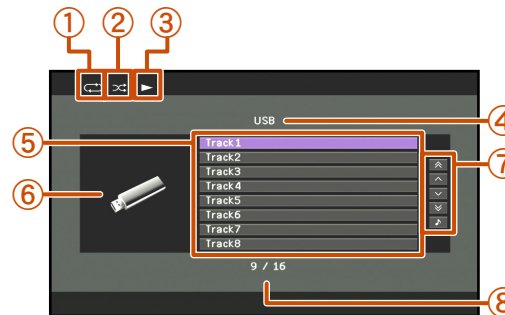

- 1 Repeat icon
- 2 Shuffle icon
- 3 Play icon
- 4 Current directory name
- 5 Menu items
- 6 Input icon
- 7 Screen button area
Buttons for available operations are displayed. See “Screen buttons on the Browse view” for details.
- 8 Current menu number / Number of all menu items

Screen buttons on the Browse view

To use these buttons, first press [9]Cursor ▷. Then select the desired one with [9]Cursor △ / ▽ and [9]ENTER.

10 Pages Up

10 Pages Down

Goes to 10 pages forwards or backwards.

1 Page Up

1 Page Down

Scrolls the list to the next or previous page.

Now Playing

Switches the display to the Now Playing view.

1 Connect your USB storage device to the USB port on the front panel (p. 41).

2 Rotate the INPUT selector (or press [4]USB) to select “USB” as the input source.

3 Press [9]Cursor △ / ▽ / ◀ / ▶ to select a music file to play back.

- To select a file or folder, press [9]Cursor △ / ▽.
- To confirm the selection, press [9]ENTER.
- To return to the previous menu, press [9]RETURN.

4 Press [9]ENTER to start playback.
The Now Playing view appears during playback.



Operating from the Now Playing view

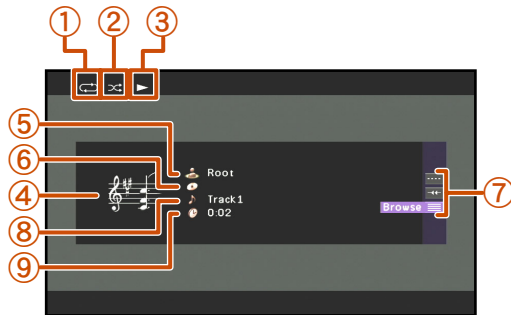

- ① Repeat icon
- ② Shuffle icon
- ③ Play icon
- ④ Album image
- ⑤ Artist name
- ⑥ Album title
- ⑦ Screen button area
- ⑧ Song title
- ⑨ Elapsed time

- You can switch the information displayed on the front panel display by pressing **[22]INFO** (see p. 11).
- Album images are available only when the file contains image data.

Screen buttons on the Now Playing view

To use these buttons, first press **[9]ENTER**. Then select the desired one with **[9]Cursor Δ / ▽** and **[9]ENTER**.

Play Control

Operates the basic playback functions of USB.

(Stop)	Stops playback.
(Skip -)	Skips to the beginning of the currently playing song. Press [9]ENTER at the beginning of the song to skip to a previous song.
(Skip +)	Skips to the beginning of the next song.

Scroll

Switches the scroll target (artist name, album title, or song title).

Browse

Switches the display to the Browse view.

Operating basic playback functions with the remote control

Use the following remote control keys to operate (playback, stop, skip, etc.) USB storage device.

[7]	Play
[7]	Stop
[7]	Skip forward during playback
[7]	Skip backward during playback

Shuffle/repeat playback

Use the Option menu to apply playback shuffle and repeat settings. Refer to “Shuffle playback” (see p. 65) and “Repeat playback” (see p. 65) for details.

Listening to the Internet Radio

You can listen to Internet Radio stations using the vTuner Internet Radio station database service particularly customized for this unit, providing a database of over 2000 radio stations. Also, you can store your favorite stations with bookmarks.

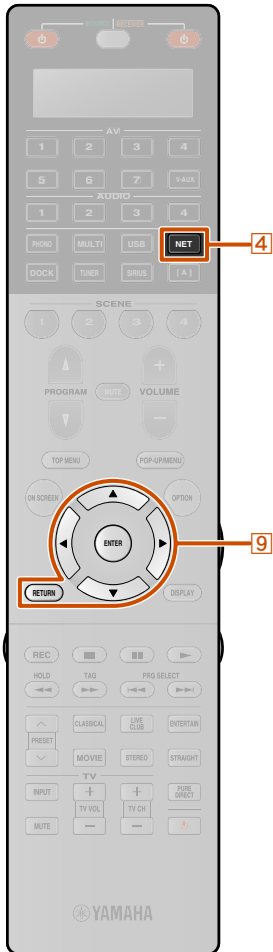

- To use this feature, your network must be connected to the Internet.
- A narrowband Internet connection (i.e. 56K modem, ISDN) will not provide satisfactory results, and a broadband connection is strongly recommended (i.e. a cable modem, an xDSL modem, etc.). For detailed information, consult with your ISP.
- If you do not use a DHCP server, configure the network parameters (IP address, etc.) of this unit manually ([p. 125](#)).
- Some security devices (such as firewall) may block the access of this unit to Internet Radio stations. In such cases, configure the security settings appropriately.
- This service may be discontinued without notice.
- Some Internet Radio stations may not be played.

Listening to Internet Radio

For a complete list of status messages that appear on the front panel display and GUI screen, see “USB and Network” ([p. 161](#)).

The Internet Radio can be operated from the menu displayed on the TV screen.

You can operate the Internet Radio from the Now Playing view or the Browse view.

Operating from the Browse view

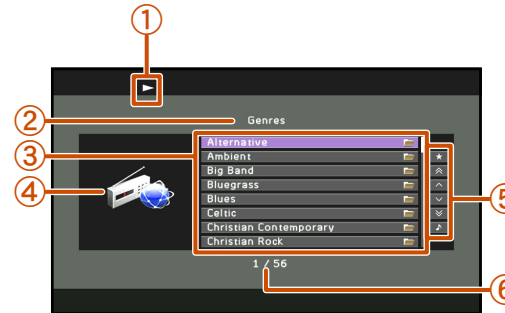

- 1 **Play icon**
- 2 **Current directory name**
- 3 **Menu items**
- 4 **Album art / Input icon**
- 5 **Screen button area**
Buttons for available operations are displayed. See “Screen buttons on the Browse view” for details.
- 6 **Current menu number / Number of all menu items**

Screen buttons on the Browse view

To use these buttons, first press **[9]Cursor >**. Then select the desired one with **[9]Cursor Δ / ▽** and **[9]ENTER**.

Bookmark On

The selected Internet Radio station is added to the Bookmarks list in “NET RADIO.”

Bookmark Off

This item is displayed in the bookmark directory. The selected Internet Radio station is removed from the Bookmarks list.

10 Pages Up

10 Pages Down

Goes to 10 pages forwards or backwards.

1 Page Up

1 Page Down

Scrolls the list to the next or previous page.

Now Playing

Switches the display to the Now Playing view.

1 Press [4]NET repeatedly to select “NET RADIO” as the input source.

2 Press [9]Cursor Δ / ▽ to select an item to play back.

- To select an item, press **[9]Cursor Δ / ▽**.
- To confirm the selection, press **[9]ENTER**.
- To return to the previous menu, press **[9]RETURN**.

3 Press [9]ENTER to start playback.

The Now Playing view appears during playback.

Operating from the Now Playing view

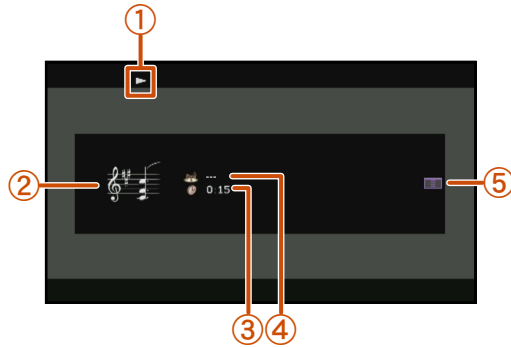

- ① Play icon
- ② Album image
- ③ Elapsed time
- ④ Current station name
- ⑤ Screen button area

Buttons for available operations are displayed. See “Screen buttons on the Now Playing view” for details.

You can switch the information displayed on the front panel display by pressing **[22]INFO** (p. 11).

Screen buttons on the Now Playing view

To use these buttons, first press **[9]ENTER**. Then select the desired one with **[9]Cursor Δ / ▽** and **[9]ENTER**.

Bookmark On

The station currently being played back is added to the Bookmarks list in “NET RADIO.”

Play Control

The following operation is available.

(Stop)	Stops playback.
--------	-----------------

Browse

Switches the display to the Browse view.

Operating basic playback functions with the remote control

Use the following remote control keys to operate (playback, stop) the Internet Radio.

[7]	Play
[7]	Stop

You can also register your favorite Internet Radio stations on this unit by accessing the website with the web browser on your PC. To use this feature, you need the vTuner ID of this unit and your e-mail address to create your personal account. For details, refer to the help information on the website.
URL: <http://yradio.vtuner.com/>

NOTE

To clear the personal account such as vTuner ID or e-mail address, perform “NETWORK” of “INITIALIZE” in the Advanced Setup menu (p. 147).



Using the Rhapsody® service

Prohibition

It is strictly prohibited to modify, reproduce, reverse-engineer or use this unit and/or built-in software for use other than audiovisual purposes.

The Rhapsody® service is the power behind the Rhapsody® Media Player (the Rhapsody® player software that you can download to your computer). Rhapsody® service supplies the music, keeps My Library up to date, provides you with Rhapsody® channels, the Playlist Central online community, and manages your downloads. Your software connects to Rhapsody® service through the internet. Because your account information and Rhapsody® content are on servers instead of any individual computer, your music is infinitely portable. Much of what you see in the Display area comes from Rhapsody® service. What you can do with Rhapsody® service depends on your subscription. You can use Rhapsody® service for free, or get even more from a paid membership. The Rhapsody® service also brings you Rhapsody® Online, a streamlined, internet version of Rhapsody® that you can access from almost anywhere. Just sign in to your Rhapsody® account to start letting the Rhapsody® service work for you.

For more information, <http://www.rhapsody.com/>

Rhapsody® account sign-in

When you select “Rhapsody” for the first time, the sign-in screen appears. Sign in to your Rhapsody® account to start using the Rhapsody service on this unit.

Use the Utility function later to view information for your Rhapsody® account.

1 Press **[8] ON SCREEN**.

2 Use **[9] Cursor Δ / ▽** to select “Input” and press **[9] ENTER**.

3 Use **[9] Cursor < / >** to select “Rhapsody” and press **[9] Cursor Δ**.

The following display appears when “Sign In” has not been completed yet. Read the description and then press **[9] ENTER**. 

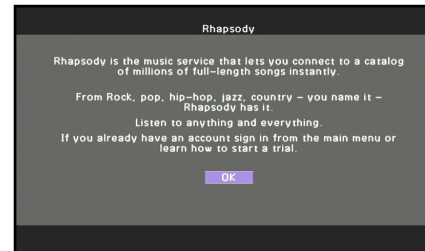

4 Press **[9] Cursor Δ / ▽** to select “Sign In” and then press **[9] ENTER**.

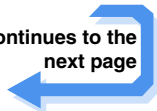

If “Rhapsody Trial” is selected, the URL for free 30-day trial service content is displayed. You can get started with a free trial by registering an account in the specified website.

Continues to the next page 

 **1**: When “Sign In” has not been completed yet, this description can be directly displayed by pressing **[4] NET** repeatedly to select “Rhapsody” as input source.



5 Press **9**ENTER to enter the User Name entry screen.

6 Use **9**Cursor $\Delta / \nabla / \langle / \rangle$ and **9**ENTER to enter your user name password (up to 64 characters) and then select “OK” and press **9**ENTER.

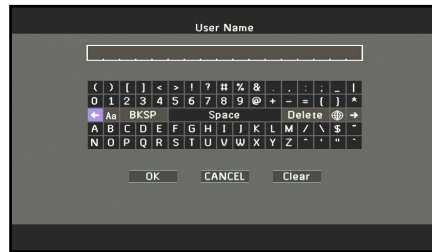

To clear the characters entered in step 6 and 8, select “CLEAR” and press **9**ENTER.

7 Press **9**ENTER to enter the User Password entry screen.

8 Use **9**Cursor $\Delta / \nabla / \langle / \rangle$ and **9**ENTER to enter your password (up to 64 characters) and then select “OK” and press **9**ENTER.

“Please wait” appears followed by the confirmation screen.

NOTE

If registration failed, the error message appears. In this case, read the message and start all over again.

9 Press **9**ENTER.
The Rhapsody Browse view is displayed.

Playback of Rhapsody® contents

The Rhapsody can be operated from the content window on the TV screen.

You can operate the Rhapsody from the Now Playing view or the Browse view.

Operating from the Browse view

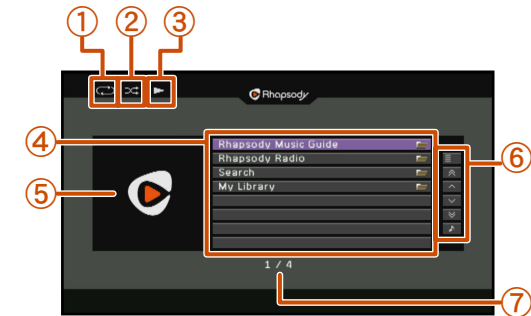

- ① Repeat icon
- ② Shuffle icon
- ③ Play icon
- ④ Menu items
- ⑤ Album art / Input icon
- ⑥ Screen button area
Buttons for available operations are displayed. See “Screen buttons on the Browse view” for details.
- ⑦ Current menu number / Number of all menu items



Screen buttons on the Browse view

To use these buttons, first press **[9]Cursor ▷**. Then select the desired one with **[9]Cursor △ / ▽** and **[9]ENTER**.

Utility

Play	Plays back the song or album highlighted in the list.
Add track to My Library	Adds the track currently selected to "My Library."
Add album to My Library	Adds the album currently selected to "My Library."
Add CH to My Library	Adds the channel currently selected to "My Library."
Remove from My Library	Removes the content currently selected from "My Library."

10 Pages Up

10 Pages Down

Goes to 10 pages forwards or backwards.

1 Page Up

1 Page Down

Scrolls the list to the next or previous page.



Now Playing

Switches the display to the Now Playing view.

You can navigate the Rhapsody menu with the following remote control buttons.

1 Press [4]NET repeatedly to select "Rhapsody" as the input source.

2 Press [9]Cursor △ / ▽ to select an item to play back.

- To select an item, folder or file, press **[9]Cursor △ / ▽**.
- To confirm the selection, press **[9]ENTER**.
- To return to the previous menu, press **[9]RETURN**.

Rhapsody Music Guide	Select a track from the lists organized by category (artist, album, etc.).
Rhapsody Radio	Select a network radio channel from the lists of the channels provided by Rhapsody.
Search	Use the software keyboard to search the desired item (artist, album, etc.) by keyword.
My Library	Select a track from items (artist, album, etc.) added to "My Library."

3 Press [9]ENTER to start playback.

The Now Playing view appears during playback.

Operating from the Now Playing view

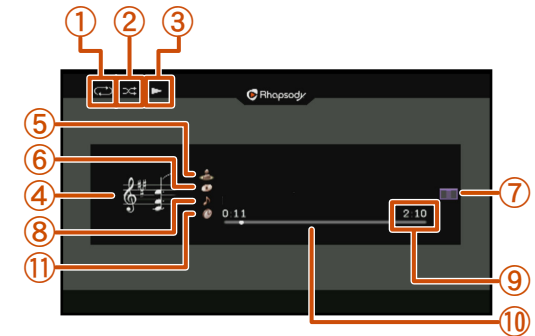

- Repeat icon**
- Shuffle icon**
- Play icon**
- Album image**
- Artist name**
- Album title**
- Screen button area**
Buttons for available operations are displayed. See "Screen buttons on the Now Playing view" for details.
- Song title**
- Total playback time**
- Progress bar**
- Elapsed time**

- You can switch the information displayed on the front panel display by pressing **[22]INFO** (p. 11).
- Album images are available only when the file contains image data.





Screen buttons on the Now Playing view

To use these buttons, first press **9** **ENTER**. Then select the desired one with **9** **Cursor** Δ / ∇ and **9** **ENTER**.

Play Control

Operates the basic playback functions of PC.

▷ (Play)	Starts playback.
□ (Stop)	Stops playback.
⏸ (Pause)	Stops playback temporarily.
⏮ (Skip -)	Skips to the beginning of the currently playing song. Press 9 ENTER at the beginning of the song to skip to a previous song.
⏭ (Skip +)	Skips to the beginning of the next song.

Utility

Add track to My Library	Adds the track currently selected to "My Library."
Add album to My Library	Adds the album currently selected to "My Library."
Add CH to My Library	Adds the channel currently selected to "My Library."

Scroll

Switches the scroll target (artist name, album name, or song name).

Browse

Switches the display to the Browse view.

Operating basic playback functions with the remote control

Use the following remote control keys to operate (playback, stop, skip, etc.) your PC contents.

7 ▷	Play
7 □	Stop
7 ⏸	Switches between playback and pause.
7 ⏭	Skip forward during playback
7 ⏮	Skip backward during playback

Shuffle/repeat playback

Use the Option menu to apply playback shuffle and repeat settings. Refer to "Shuffle playback" ([p. 65](#)) and "Repeat playback" ([p. 65](#)) for details.

Listening to the SIRIUS Internet Radio

It's easy to enjoy SIRIUS entertainment at home. Listen to over 80 channels of commercial-free music, plus sports talk, news and entertainment. It all comes through your audio / video receiver and high-speed Internet connection.

If you're not a SIRIUS subscriber, you can sign up today for a PREMIUM SIRIUS Internet Radio subscription at www.sirius.com <<http://www.sirius.com/>>.

Current subscribers can add a PREMIUM SIRIUS Internet Radio subscription to an existing account.

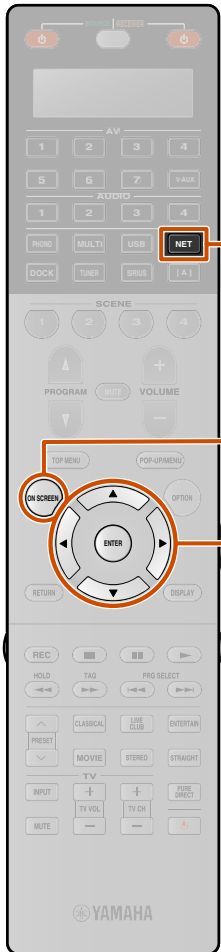

SIRIUS Internet Radio account sign-in

When you use the SIRIUS Internet Radio service for the first time, follow the procedure below to sign in to your account for the service.

1 Press **[8] ON SCREEN**.

2 Use **[9] Cursor Δ / ▽** to select "Input" and press **[9] ENTER**.

3 Use **[9] Cursor < / >** to select "SIRIUS IR" and press **[9] Cursor Δ**.

The following display appears when "Sign In" has not been completed yet. Read the description and then press **[9] ENTER**. 

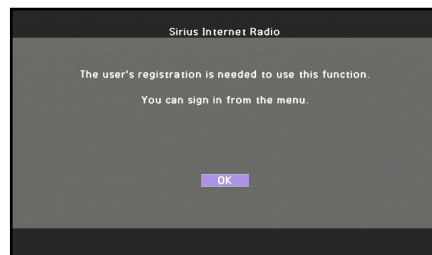

4 Press **[9] Cursor Δ / ▽** to select "Sign In" or "SIRIUS IR Trial" and then press **[9] ENTER**.

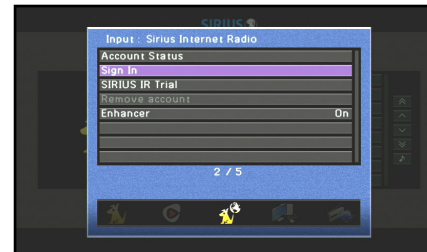

If "SIRIUS IR Trial" is selected, the confirmation message and the URL regarding the terms of trial service are displayed. Press **[9] Cursor < / >** to select "OK" to continue. If "Successfully logged into account" is displayed, press **[9] ENTER** to enable the Sirius Internet Radio Browse view.

5 Press **[9] ENTER** to enter the User Name entry screen.

6 Use **[9] Cursor Δ / ▽ / < / >** and **[9] ENTER** to enter your user name password (up to 64 characters) and then select "OK" and press **[9] ENTER**.

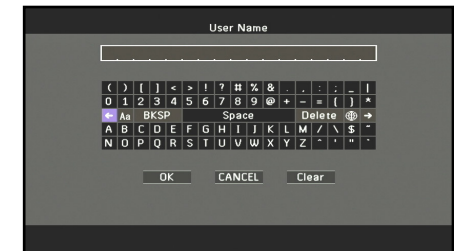

To clear the characters entered in step 6 and 8, select "CLEAR" and press **[9] ENTER**.

7 Press **[9] ENTER** to enter the User Password entry screen.

Continues to the next page 

 **1**: When "Sign In" has not been completed yet, this description can be directly displayed by pressing **[4] NET** repeatedly to select "Sirius Internet Radio" as input source.

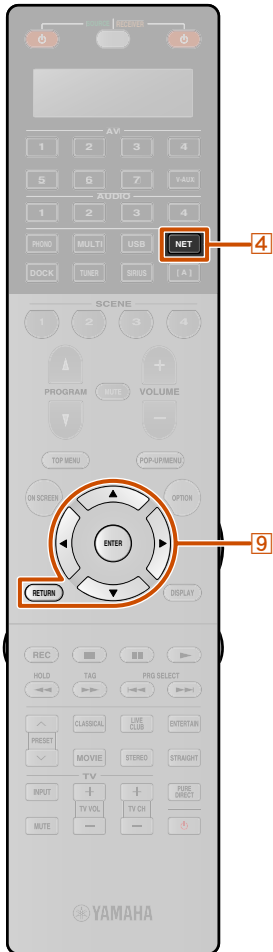

- 8** Use **[9]Cursor** $\Delta / \nabla / \leftarrow / \rightarrow$ and **[9]ENTER** to enter your password (up to 64 characters) and then select “OK” and press **[9]ENTER**.

“Please wait...” is first displayed, followed by confirmation screen.

NOTE

If registration failed, the error message appears. In this case, read the message and start all over again.

- 9** Press **[9]ENTER**.
The Sirius Internet Radio Browse view is displayed.

Navigating the Sirius Internet Radio menu

The SIRIUS Internet Radio tuner can be operated from the content window on the TV screen.

You can operate the SIRIUS Internet Radio from the Now Playing view or the Browse view.

Operating from the Browse view



- ① **Play icon**
- ② **Menu items**
- ③ **Album art / Input icon**
- ④ **Screen button area**
Buttons for available operations are displayed. See “Screen buttons on the Browse view” for details.
- ⑤ **Current menu number / Number of all menu items**

Screen buttons on the Browse view

To use these buttons, first press **[9]Cursor** \triangleright . Then select the desired one with **[9]Cursor** Δ / ∇ and **[9]ENTER**.

10 Pages Up

10 Pages Down

Goes to 10 pages forwards or backwards.

1 Page Up

1 Page Down

Scrolls the list to the next or previous page.

Now Playing

Switches the display to the Now Playing view.

You can navigate the Sirius Internet Radio menu with the following remote control buttons.

- 1** Press **[4]NET** repeatedly to select “Sirius Internet Radio.”

- 2** Press **[9]Cursor** $\Delta / \nabla / \leftarrow / \rightarrow$ to select a music file to play back.

- To select a file or folder, press **[9]Cursor** Δ / ∇ .
- To confirm the selection, press **[9]ENTER**.
- To return to the previous menu, press **[9]RETURN**.

- 3** Press **[9]ENTER** to start playback.
The Now Playing view appears during playback.



Operating from the Now Playing view

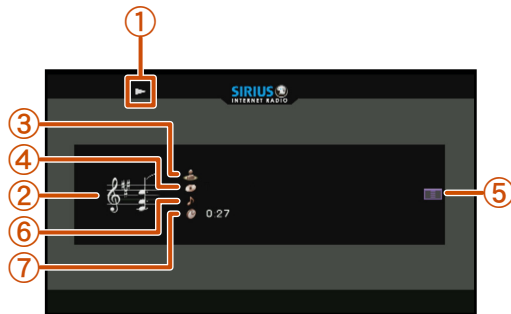

- ① **Play icon**
- ② **Album image**
- ③ **Artist name**
- ④ **Album title**
- ⑤ **Screen button area**
Buttons for available operations are displayed. See “Screen buttons on the Now Playing view” for details.
- ⑥ **Song title**
- ⑦ **Elapsed time**

- You can switch the information displayed on the front panel display by pressing **[22]INFO** (p. 11).
- Album images are available only when the file contains image data.

Screen buttons on the Now Playing view

To use these buttons, first press **[9]ENTER**. Then select the desired one with **[9]Cursor Δ / ▽** and **[9]ENTER**.

Play Control

Stops the current playback.

[] (Stop)	Stops playback.
-------------------	-----------------

Scroll

Switches the scroll target (artist name, album name, or song name).

Browse

Switches the display to the Browse view.

Operating basic playback functions with the remote control

Use the following remote control keys to operate (playback, stop, skip, etc.) your PC contents.

[7]▶	Play
[7]□	Stop



Using shortcut function

Use this feature to access the desired music sources (WAV, MP3 and WMA files on the connected PC or USB storage devices, Internet Radio Stations, SIRIUS Internet Radio and Rhapsody® music contents) directly. You can preset up to 40 items for above input sources.

■ Assigning the items to the preset number

1 Select a desired content you want to assign to a preset number, and then play back the content.

2 Press **[26]MEMORY**. This unit automatically selects an empty preset number and the following display appears.



Preset number (Blinks)

- To automatically assign the selected content to an empty preset number, press and hold **[26]MEMORY** for at least 2 seconds with step 2. In this case, the following steps are unnecessary.
- To cancel the preset, press **[9]RETURN**.
- When you do not complete each of the following steps within 30 seconds, the memory preset mode is automatically canceled. In this case, start over from step 2.

3 Press **[10]PRESET ^ / v** or **[23]Numeric keys** to select the preset number that you want to assign.



Valid numbers as the preset number are “01” to “40.”

4 Press **[26]MEMORY**. The following display appears on the front panel display and the preset content is set.



■ Selecting the item assigned to the preset number

Press **[10]PRESET ^ / v** to select the preset number to which the desired item is assigned to select the item as the input source.

This unit starts the playback of the source assigned to the selected numeric button.

NOTES

- “xx:Empty” appears on the front panel display when you select the preset number to which no items are assigned.
- This unit does not recall the correct item assigned to the selected preset number in the following cases:
 - the connected USB device is incorrect.
 - the PC which stores the selected item is turned off or disconnected from the network.
 - the selected Internet Radio station, Rhapsody service or SIRIUS Internet Radio is temporary unavailable or out of service.
 - the directory of the selected item has been changed.

This unit stores the relative position of the preset items in a directory or playlist, and does not recall the correct item by using **[23]Numeric keys** if you add or delete music files to or from the same directory or playlist as the preset items. In such cases, preset the desired item to the preset numbers again.

We recommend the following methods:

USB storage devices

Create several directories containing the desired content in a directory beside the directory containing all music files, and then assign the top item of each directory to a preset number. To change the content assigned to preset numbers, replace the content in the directory to new content without deleting the directory.

PC server

Create eight playlists containing the desired content, and then assign the top item of each playlist to a preset number. To change the content assigned to preset numbers, replace the content registered with a playlist with new content without deleting the playlist.

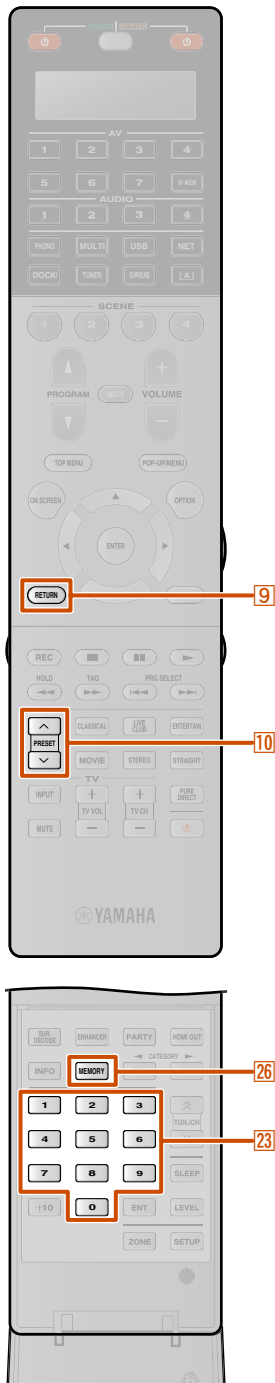

Playing back tunes from your iPod™/iPhone™

Once you have connected a Universal Dock for iPod (such as the YDS-12, sold separately) to this unit, you can enjoy playback of your iPod/iPhone using the remote control supplied with this unit. When playing back from an iPod/iPhone, you can also use the compressed music enhancer sound programs to give compressed audio formats such as MP3 a sharper, more dynamic sound ([esp. 57](#)). A Yamaha Wireless System for iPod (YID-W10, sold separately) can also be connected to this unit to play back iPod/iPhone with wireless connection.



• When playing back iPod/iPhone with wired connection

Refer to “Connecting the Universal Dock for iPod.”

• When playing back iPod/iPhone with wireless connection

Refer to “Playing iPod™/iPhone™ with wireless connection” ([esp. 96](#)).

Connecting the Universal Dock for iPod

Use the dedicated cable to connect the dock to the DOCK jack on the rear panel of this unit. Refer to the operating instructions of the Universal Dock for iPod for information on how to connect your iPod/iPhone.

- iPod touch, iPod (4th Gen/5th Gen/Classic), iPod nano, iPod mini, iPhone, iPhone 3G, and iPhone 3GS are supported (As of March 2010).
- When connecting iPhone, iPhone 3G and iPhone 3GS, use a YDS-12.
- Some features may not be compatible depending on the model or the software version of your iPod/iPhone.
- Some functions may not be available for some Universal Dock for iPod models. This explanation focuses on the YDS-12.
- When an iPod that supports iTunes Tagging is connected to this unit, this unit transmits iTunes Tagging information to the iPod ([esp. 71](#)).

CAUTION

To prevent accidents, switch this unit to standby mode before connecting the Universal Dock for iPod.

Switch this unit on and place your iPod/iPhone in the dock. The unit is now ready for playback.

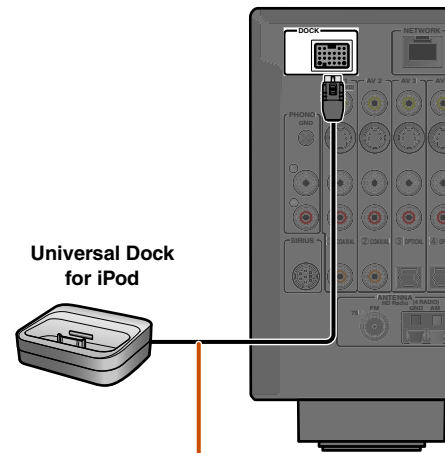

Locate the wireless dock at the distance as far as from the unit.

When this unit is in standby mode, iPod/iPhone can be charged automatically ([esp. 104](#)).

Controlling an iPod™/iPhone™

After setting your iPod/iPhone in your dock, just press **4 DOCK** to switch to DOCK input to play your iPod/iPhone.

The iPod/iPhone can be operated in the following two ways.

Menu browse control:

Plays the iPod/iPhone while viewing the menu displayed on the TV. Refer to “Playing iPod™/iPhone™ from the menu screen (Menu browse control)” ([esp. 95](#)).

Simple remote control:

Plays audio and video through this unit while viewing the menu displayed on the iPod/iPhone screen. Refer to “Operating basic playback functions via the remote control (Simple remote control)” ([esp. 96](#)).

- Song information (artist, album, song) is displayed on the front panel. Press **22 INFO** repeatedly to display subsequent/previous information when displaying Now Playing view in Menu browse control.
- The Yamaha logo is displayed on the iPod screen when iPod stationed in the Universal Dock for iPod (does not apply to the iPod touch or iPhone). However, the Yamaha logo is not displayed in Simple remote control.
- Manual control of the iPod/iPhone is not possible while the iPod stationed in the Universal Dock for iPod and Menu browse control is displayed.

Playing iPod™/iPhone™ from the menu screen (Menu browse control)

The iPod/iPhone can be operated from the menu displayed on the TV screen.

You can operate the iPod/iPhone from the Now Playing view or the Browse view.

Operating from the Browse view

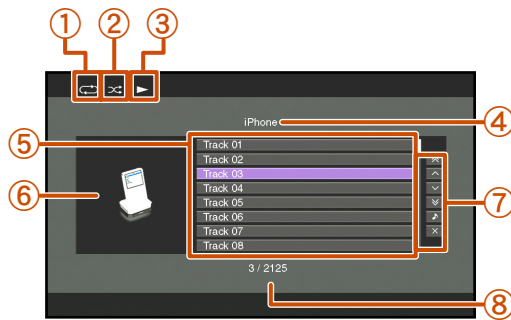

- ① Repeat icon
- ② Shuffle icon
- ③ Play icon
- ④ Current directory name
- ⑤ Menu items
- ⑥ Input icon
- ⑦ Screen button area
- Buttons for available operations are displayed. See “Screen buttons on the Browse view” for details.
- ⑧ Current menu number / Number of all menu items

Screen buttons on the Browse view

To use these buttons, first press **9** Cursor Δ / ∇ . Then select the desired one with **9** Cursor Δ / ∇ and **9** ENTER.

10 Pages Up

10 Pages Down

Goes to 10 pages forwards or backwards.

1 Page Up

1 Page Down

Scrolls the list to the next or previous page.

Now Playing

Switches the display to the Now Playing view.

Close

Returns to the video playback, turning off the menu display.

1 Press **4** DOCK to switch to the DOCK input.

2 Press **9** Cursor Δ / ∇ to select the content (music or video) that you want to play, and press **9** ENTER. 🌱1

3 Press **9** Cursor Δ / ∇ to select iPod/iPhone menu items, and press **9** ENTER to play.

The Now Playing view appears during playback. 🌱2

Operating from the Now Playing view

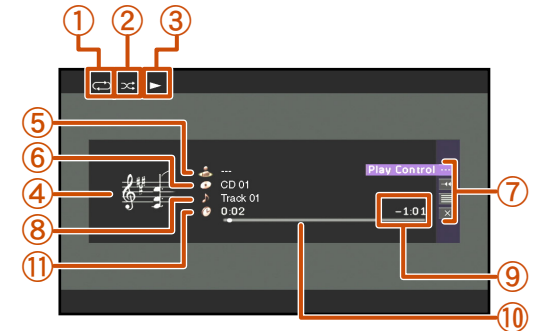

- ① Repeat icon
- ② Shuffle icon
- ③ Play icon
- ④ Album image
- ⑤ Artist name
- ⑥ Album title
- ⑦ Screen button area
- Buttons for available operations are displayed. See “Screen buttons on the Now Playing view” for details.
- ⑧ Song title
- ⑨ Remaining time
- ⑩ Progress bar
- ⑪ Elapsed time

🌱1 : Videos will not be displayed when your iPod or Universal Dock for iPod do not support the browser function for browsing video files.

🌱2 : When selecting the video content, the following display is not displayed.

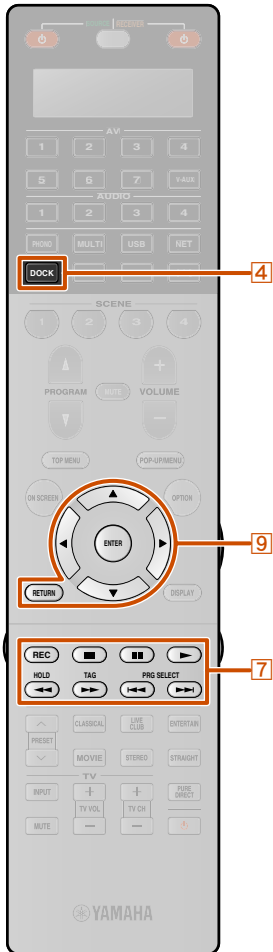

Screen buttons on the Now Playing view
To use these buttons, first press **[9]ENTER**. Then select the desired one with **[9]Cursor Δ / ▽** and **[9]ENTER**.

Play Control

Operates the basic playback functions of iPod/iPhone.

[▷] (Play)	Starts playback.
[◻] (Stop)	Stops playback.
[⏸] (Pause)	Stops playback temporarily.
[⏮] (Skip -)	Skips to the beginning of the currently playing song. Press [9]ENTER at the beginning of the song to skip to a previous song.
[⏭] (Skip +)	Skips to the beginning of the next song.
[⏪] (Scan -)	Searches backwards.
[⏩] (Scan +)	Searches forwards.

Scroll

Switches the scroll target (artist name, album title, or song title).

Browse

Switches the display to the Browse view.

Close

Returns to the video playback, turning off the menu display.

Operating basic playback functions via the remote control (Simple remote control)

Use the following remote control keys to operate (playback, stop, skip, etc.) your iPod/iPhone. Press **[7]REC** to enable the Simple remote control. Press **[7]REC** again to return to the Menu browse control.

[4]DOCK	Switches to the DOCK (iPod) input.
[9]Cursor Δ / ▽	Move the cursor up and down to different fields.
[9]RETURN	Returns to the previous menu.
[9]ENTER	Confirms the selected menu.
[7]⏮	Searches backwards while held down.
[7]⏭	Searches forwards while held down.
[7]⏮	Skips to the beginning of the currently playing song. Pressing repeatedly skips one song backwards with each press.
[7]⏭	Skips to the beginning of the next song.
[7]◻	Stops playback.
[7]⏸	Switches between playback and pause.
[7]▷	Switches between playback and pause.
[7]REC	Switches the control method between the Menu browse control and Simple remote control.

Playing iPod™/iPhone™ with wireless connection

A Wireless System for iPod (YID-W10, sold separately) can be connected to this unit to play back iPod/iPhone with wireless connection. The iPod/iPhone can be used as the remote control.  1

Connecting the Wireless System for iPod and playing back iPod/iPhone

Use the dedicated cable to connect the receiver of the Wireless System for iPod to the DOCK jack on the rear panel of this unit. Refer to the operating instructions of the YID-W10 for more information.

CAUTION

To prevent accidents, unplug the power cable of this unit before connecting the receiver of the Wireless System for iPod.

Continues to the next page

 1 : Video signals cannot be transmitted wirelessly.



Place the iPod/iPhone in the wireless transmitter. Setup is complete.

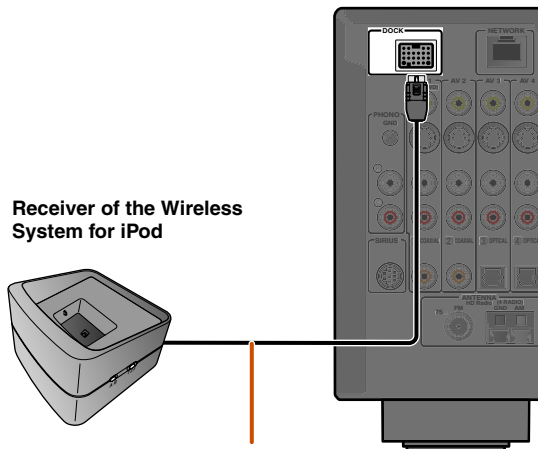

Position the receiver as far as possible from the unit.

When this unit is in standby mode, iPod/iPhone can be charged automatically, if “Standby Charge” is set to “Auto” (p. 104) or “Power & Input” of “iPod Interlock” is set to “On” (p. 105).

Use iPod/iPhone to start playback.

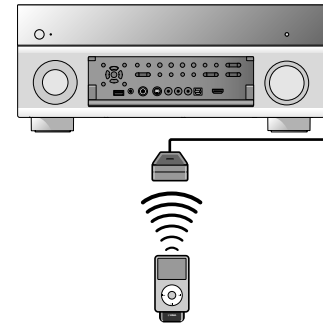

- This unit, which is placed in the main zone, functions as follows when iPod/iPhone controls are used to start playback.
 - The input source switches to DOCK (iPod) when this unit is turned on.
 - When this unit is in standby mode when iPod/iPhone playback starts, this unit turns on and the input source switches to DOCK (iPod). 📶1
- This unit automatically enters standby mode when the following operations are performed.
 - iPod/iPhone is removed from the YID-W10
 - iPod/iPhone is not operated for a while after playback is stopped

- Pressing **4DOCK** also switches the input source to DOCK (iPod).
- When a menu is operated, this function is not activated.
- When “iPod Interlock” → “Power & Input” in the Input menu is set to “Off,” the power and the input source do not switch automatically (p. 105).

- Adjusting volume control on the iPod/iPhone also adjusts the volume (max 0.0 dB) of this unit.

- When “iPod Interlock” → “Volume” in the Input menu is set to “Off,” the volume of this unit is not adjusted when iPod/iPhone volume controls are adjusted (p. 105).
- This unit may restrict the volume level to prevent excessively loud playback. In such a case, gradually increase the volume level.

CAUTION

When iPod/iPhone controls are used to adjust volume, playback volume may be unexpectedly loud. This could result in damage to this unit or the speakers. If the volume suddenly increases during playback, immediately remove the iPod/iPhone from the Wireless System for iPod. “Max Volume” can be used to specify the maximum volume level to prevent excessively loud playback (p. 120).

📶1: This function is also activated when sound of application is reproduced or ringtone is received.

Playing back tunes from Bluetooth™ components

You can connect a Yamaha Bluetooth Wireless Audio Receiver (such as the YBA-10, sold separately) to this unit and enjoy wireless playback from Bluetooth-compatible portable music players. 🌟1

NOTE

When playing back from a Bluetooth component for the first time, you must first pair the devices (register the Bluetooth components). When establishing a wireless connection you must carry out pairing on both this unit and on the Bluetooth component.

Connecting a Yamaha Bluetooth Wireless Audio Receiver

Use the dedicated cable to connect the dock to the DOCK jack on the rear panel of this unit. The Bluetooth Wireless Audio Receiver connection will be complete when this unit is turned on.

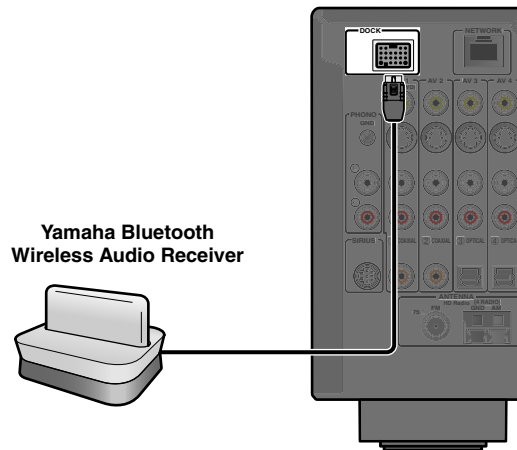

CAUTION

To prevent accidents, switch this unit to standby mode before connecting a Bluetooth Wireless Audio Receiver.

Pairing Bluetooth™ components

Be sure to carry out pairing when connecting a Bluetooth component for the first time, or when settings have been deleted. Refer to the operating instructions of your Bluetooth component as necessary when carrying out pairing.

The Yamaha Bluetooth Wireless Audio Receiver can be paired with up to eight Bluetooth components. When the ninth device is paired, the pairing settings for the device which has not been used for the longest period of time will be deleted.

- 1 Press **4 DOCK** to switch to the DOCK input.
- 2 Turn on the Bluetooth component you want to pair with and set it to pairing mode.
- 3 Press **16 OPTION** to display the Option menu and use **9 Cursor** Δ / ∇ to select "Pairing."



- 4 Press **9 ENTER** to start pairing.



- To cancel pairing, press **9 RETURN**.
- You can also press and hold **26 MEMORY** on the front panel to begin pairing.

- 5 Make sure the Bluetooth component recognizes the Bluetooth Wireless Audio Receiver.

When the device is recognized, it will appear in the Bluetooth component list, for example as "YBA-10 YAMAHA."

- 6 Select the Bluetooth Wireless Audio Receiver from the Bluetooth component list, and enter a pass key "0000" into the Bluetooth component. 🌟2

When pairing occurs correctly



🌟1: This unit supports A2DP (Advanced Audio Distribution Profile) of the Bluetooth profile.

🌟2: Depending on Bluetooth components, wireless connection is carried out right after the pairing. In this case, "BT connected" is displayed instead of "Completed."

Using Bluetooth™ components

When pairing is complete, perform the following procedure to achieve a wireless connection between this unit and the Bluetooth component. When the wireless connection is complete, Bluetooth components can be played back.

Depending on Bluetooth components, a wireless connection is established automatically or by operating the Bluetooth components. In that case, it is not necessary to carry out the following procedure.

1 Press **[4] DOCK** to switch to the DOCK input.

2 Press **[16] OPTION** to display the Option menu.

3 Use **[9] Cursor** Δ / ∇ to select “Connect” and press **[9] ENTER**.  **1**

When wireless connection is complete



“Not found” is displayed when there is an error connecting. Check that the following conditions have been satisfied, and try to establish a wireless connection again.

- Both this unit and the Bluetooth component are paired.
- The Bluetooth component is switched on.
- The Bluetooth component is within 32 ft. (10 m) of the Bluetooth Wireless Audio Receiver.

4 Press **[16] OPTION** to exit the Option menu.

5 Operate the Bluetooth component for playback.

To disconnect a wireless connection, repeat the same steps, and in step 3, select “Disconnect.”

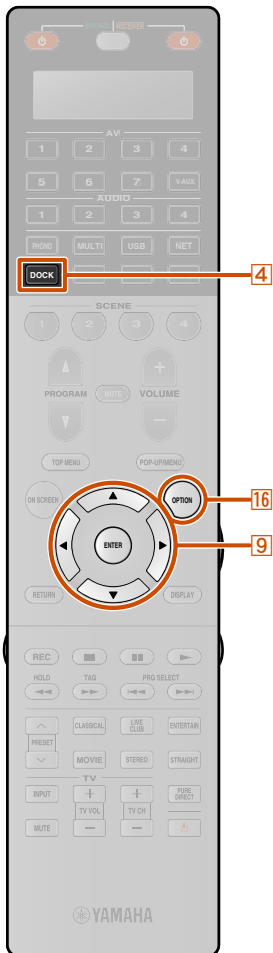

 **1**: “Disconnect” is displayed when a Bluetooth component has been connected.

Controlling this unit by using the Web browser (Web Control Center)

Displaying and Operating Web Control Center

You can operate this unit by using a web browser. You can select the input source and sound field program, browse the iPod or network/USB contents, select the preset items, and adjust the parameters of this unit by using the graphical user interface (Web Control Center) that appears in the web browser. Check the IP address of this unit by using "IP Address" in "Network" menu (p. 125) in advance, and then enter the IP address to the web browser to access this unit to control it.

NOTE

When "Network Standby" is set to "On" in the Network menu, this unit can turn on and Web Control Center can be displayed on the PC even if this unit was in standby mode (p. 125). When "Network Standby" is set to "Off," we recommend that "Network Standby" is set to "On" to use Web Control Center.

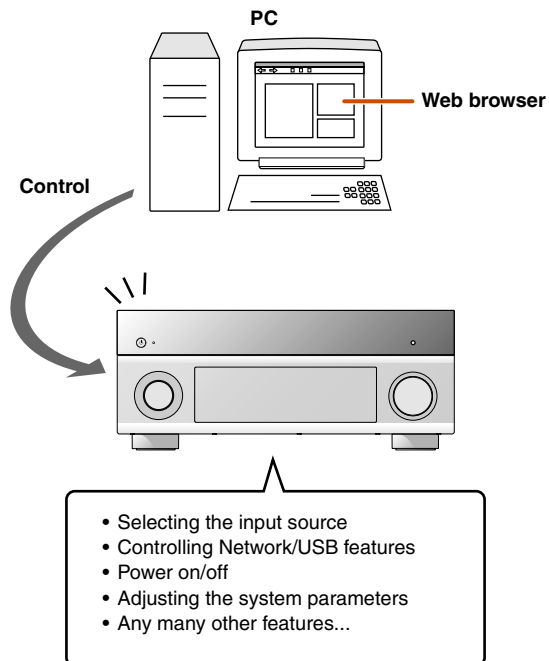

- To use this feature, this unit and your PC must be connected properly in the network. Refer to "Connecting to the network" for details on the connections (p. 40).
- We recommend that you use Windows Internet Explorer 8 that is installed on Windows XP or Windows 7 PC to access this unit.
- You can select whether this unit accepts the controls by using the web browser when this unit is in the standby mode.
- You can register the MAC address of the PCs you want to use to control this unit and limit the PCs that can control this unit by using the web browser. You can select that this unit allows the access to this unit by the PCs whose MAC addresses are registered to this unit or allows the access by any PCs by using "MAC Address Filter" in the "Network" setup (p. 125).

Features of Web Control Center for each zone

Feature	Main Zone	Zone2/Zone3	Zone4
Power on/off	✓	✓	✓
Sleep timer	✓	✓	✓
Input select	✓	✓	✓
Volume adjustment	✓	✓	—
Mute on/off	✓	✓	✓
Content/channel select	✓	✓	✓
Sound program	✓	—	—
Party Mode on/off	✓	✓	✓
Required settings for web browse control	✓	✓	✓

Top menu

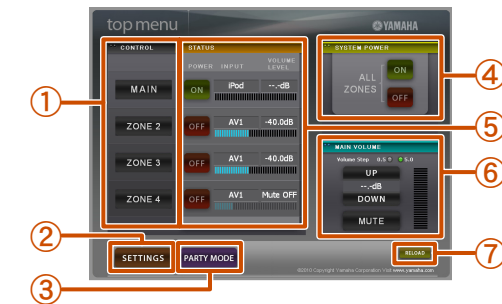

- CONTROL**
Changes the display to the zone control menu (p. 101).
- SETTINGS**
Changes the display to the settings menu (p. 101).
- PARTY MODE**
Enables/disables the party mode (p. 127).
- SYSTEM POWER**
Turns on/off the power for all zones.
- STATUS**
Turns on/off the power for each zone, and displays the selected input source and volume level for each zone.
- MAIN VOLUME**
Adjusts the volume level or mutes the sound for the main zone. You can also switch the step for the volume control.
- RELOAD**
Reloads the current status of the receiver.

Zone control menu

You can control the selected zone.





- ① **PLAY INFO**
Controls the selected input for each zone.
- ② **TOP MENU**
Returns to the top menu.
- ③ **SCENE keys**
Selects the scene.
- ④ **POWER**
Turns on/off the power for the selected zone. You can also set the sleep timer for the selected zone.
- ⑤ **VOLUME**
Adjusts the volume level or mutes the sound for the main zone. You can also switch the step for the volume control.
- ⑥ **RELOAD**
Reloads the current status of the receiver.

Settings menu

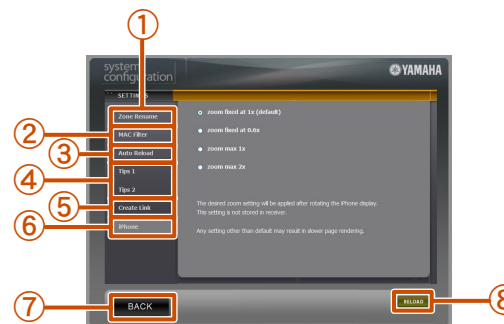
You can make various settings regarding the web browse control.



- ① **Zone Rename**
Friendly Name indicates the identification name of the device (this unit) connected to the PC.
Friendly Name or the names of zones can be changed.
- ② **MAC Filter**
Applies the MAC address filter to this unit. Web Control Center can only be accessed from a computer with the same address as the MAC address registered here.
- ③ **Auto Reload**
Enables or disables the Auto Reload function which reloads the current status of the receiver every 5 minutes.
- ④ **Tips 1/Tips 2**
Displays the tips for use of Web Control Center.
- ⑤ **Create Link**
Customizes the display of Web Control Center.
- ⑥ **iPhone **
Selects the zoom rate for iPhone.
- ⑦ **BACK**
Returns to the top menu.
- ⑧ **RELOAD**
Reloads the current status of the receiver.

 1: This item appears only when accessing the Web Control Center with the iPhone.



SETUP

Configuring input sources (Input menu)

Settings, such as the name of an input source or the icon displayed for an input source can be changed from the Input menu.

Configuring input sources

The name of an input source and its icon, as well as other input source settings, can be changed from the Input menu displayed on the TV screen.

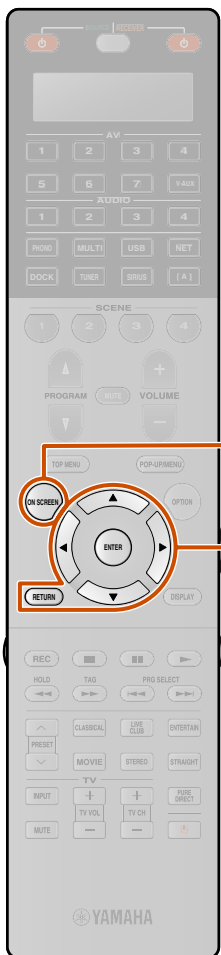

1 Press **[8]ON SCREEN**.

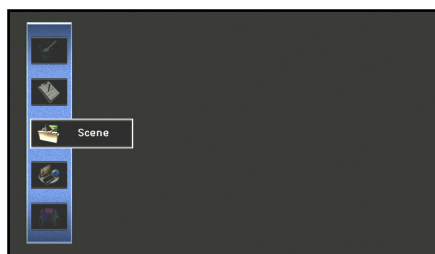

2 Use **[9]Cursor Δ / ▽** to select "Input" and press **[9]ENTER**.

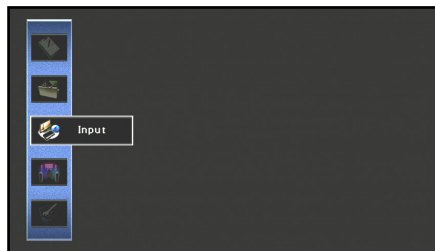

3 Use **[9]Cursor </>** to select an input source to be configured and press **[9]Cursor Δ**.

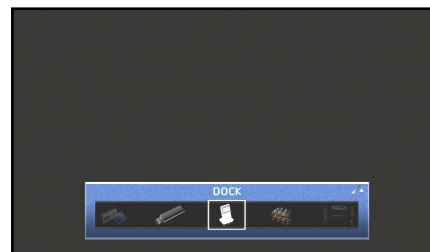

4 Use **[9]Cursor Δ / ▽** to select an item and press **[9]ENTER**.



If the selected item contains additional items, use **[9]Cursor Δ / ▽** to select the desired item and press **[9]ENTER**.

5 Use **[9]Cursor Δ / ▽** to adjust the setting.

Pressing **[9]RETURN** displays the previous menu screen. Repeat steps 4 to 5 to adjust multiple settings.

6 Press **[8]ON SCREEN** to close the menu.

Input menu

✓: available menu for each input source

	AV1-7	V-AUX	AUDIO1-4	PHONO	MULTI CH	USB	PC	NET RADIO	Rhapsody	SIRIUS IR	DOCK (iPod)	DOCK (Bluetooth)	TUNER	SIRIUS
Rename/Icon Select	✓	✓	✓	✓	✓	✓					✓	✓		
Decoder Mode	✓	✓	✓											
Enhancer	✓	✓	✓	✓		✓	✓	✓	✓	✓	✓	✓	✓	✓
DMC Control							✓							
Account Status									✓	✓				
Sign In									✓	✓				
Rhapsody Trial									✓					
Remove Account									✓	✓				
SIRIUS IR Trial										✓				
Standby Charge											✓			
iPod Interlock											✓	🌱1		
Video Out					✓									

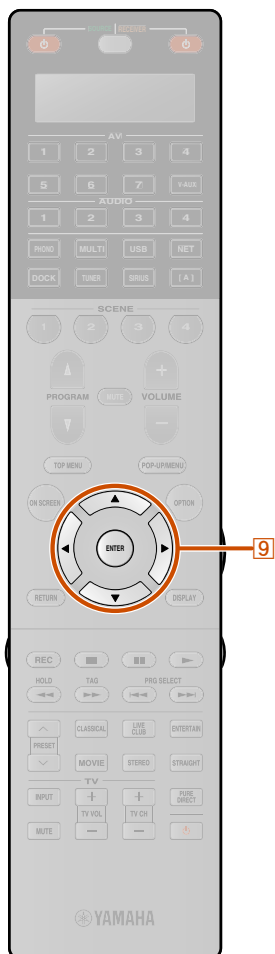

Changing an input source name or icon

Rename/Icon Select

Changes the input source name (up to nine characters) and icon displayed on the front panel display or TV screen.

1 Use **9**Cursor Δ / ∇ repeatedly to select "Rename/Icon Select" and press **9**ENTER.

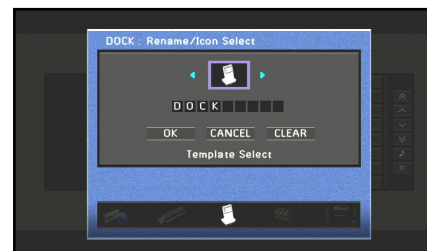

2 Use **9**Cursor \langle / \rangle to choose an icon.

3 Press **9**Cursor ∇ and **9**ENTER.
Editing the name is available.

4 Press **9**Cursor Δ / ∇ to select a character, and press **9**Cursor \langle / \rangle to enter the selected character.

5 Repeat step 4 to enter the desired input source name.

6 Confirm the input source name by pressing **9**ENTER.

7 Press **9**Cursor ∇ to select "OK" and press **9**ENTER to register the new input name.

- To cancel the operation without applying changes, select "CANCEL" and then press **9**ENTER.
- To clear the characters entered in step 5, select "CLEAR" and press **9**ENTER.

🌱1: Not available when playing back iPod/iPhone with wired connection.

Setting the format of digital audio signals

Decoder Mode

Sets the format of digital audio to playback to DTS. For example, if the format is not automatically detected correctly even during playback of DTS format audio, this item can be used to set the playback format to DTS.

Auto (Default)	The audio format is automatically selected to match the format of the input audio.
DTS	Selects DTS signals only. Other input signals are not reproduced.

Selecting the sound program suitable for listening to compressed audio, such as MP3

Enhancer

Turns on/off the Compressed Music Enhancer.

Off	Turns off the Compressed Music Enhancer.
On	Turns on the Compressed Music Enhancer.

Using a PC to control this unit over a network

DMC Control

This unit can be operated via the DLNA compatible controller (e.g., Windows Media Player, etc.) to the same network as this unit. DMC stands for “Digital Media Controller.”

Disable	Disables the DMC control function.
Enable (Default)	Enables the DMC control function.

Confirming the account of the Rhapsody service or SIRIUS Internet Radio

Account Status

Displays the current account status of Rhapsody service or SIRIUS Internet Radio.

Sign in to your account for the Rhapsody service or SIRIUS Internet Radio

Sign In

Sign in to your account for the Rhapsody service or SIRIUS Internet Radio (p. 86, p. 90).

Rhapsody Trial

Displays the URL for free 30-day trial service content. Create an account in the specified website, sign in to your account with “Sign In” to get started with a free trial.

SIRIUS IR Trial

Creates a temporary account for free 30-day trial and sign in to the account automatically.

Refer to “Rhapsody® account sign-in” (p. 86) or “SIRIUS Internet Radio account sign-in” (p. 90) for details on signing in to your account.

Removing your account from the Rhapsody service or SIRIUS Internet Radio

Remove Account

Removes an account registered with the Rhapsody service or SIRIUS Internet Radio.

Charging an iPod™/iPhone™ in standby mode

Standby Charge

Charges an iPod/iPhone stationed in the Universal Dock for iPod or the receiver of the Wireless System for iPod while the receiver is in standby mode.

Auto (Default)	This unit charges iPod/iPhone when this unit is in standby mode. While charging an iPod/iPhone, the HDMI Through/iPod Charge indicator lights. After the charging is complete, standby charge function is automatically off and the HDMI Through/iPod Charge indicator goes off. 1
Off	This unit does not charge iPod/iPhone.

1 : Standby charge function automatically turns off only when using YDS-10/11/12.

■ Setting the interlock functions with iPod/iPhone (when the receiver of the Wireless System for iPod is connected)

iPod Interlock

This unit can be automatically operated in conjunction with operations on iPod when the receiver of the Wireless System for iPod is connected to this unit.

Power & Input	Starting playback of iPod/iPhone turns on this unit and switches the input source to DOCK (iPod) automatically when this item is set to "On." This unit automatically enters standby mode when iPod/iPhone is not operated for a while after playback is stopped. This interlock function is disable with "Off."
Volume	Adjusting the volume on the iPod/iPhone also adjusts the volume of this unit when this item is set to "On." This interlock function is disable with "Off."

■ Outputting a video signal input from another input source while playing a multi-channel audio signal

Video Out

When "MULTI CH" is selected as the input source, a video signal input from another terminal can be output to the video monitor. For example, even if an audio and video component such as a DVD player that does not support a multi-channel digital audio output, the video signal can be output to the video monitor while reproducing a multi-channel analog audio signal.



Editing the SCENE function (Scene menu)

The SCENE function ([p. 54](#)) can be edited from the Scene menu displayed on the TV screen.

Editing a scene

Various settings, such as the name of a scene or the icon displayed for a scene, can be changed from the Scene menu.

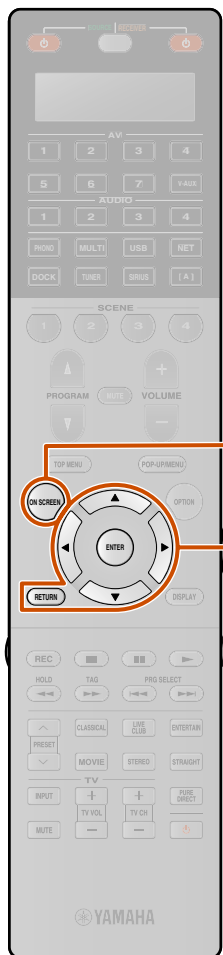

1 Press **[ON SCREEN]**.

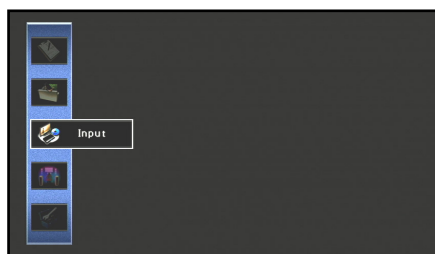

2 Use **[Cursor Δ / ▽]** to select “Scene” and press **[ENTER]**.

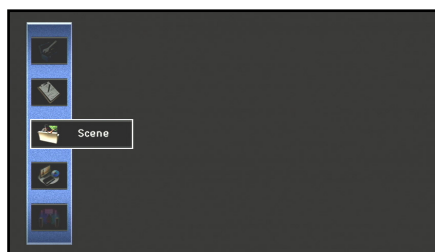

3 Use **[Cursor < / >]** to select a scene to be edited and press **[Cursor Δ]**.



4 Use **[Cursor Δ / ▽]** to select an item and press **[ENTER]**.

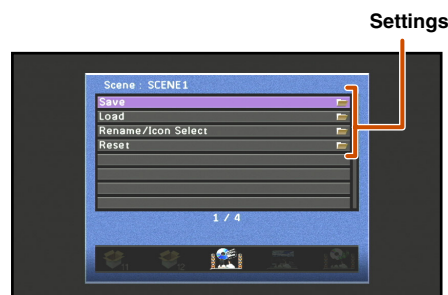

If the selected item contains additional items, use **[Cursor Δ / ▽]** to select the desired item and press **[ENTER]**.

5 Use **[Cursor Δ / ▽ / < / >]** to adjust the setting.

Pressing **[RETURN]** displays the previous menu screen. Repeat steps 4 and 5 to adjust multiple settings.

6 Press **[ON SCREEN]** to close the menu.

Scene menu

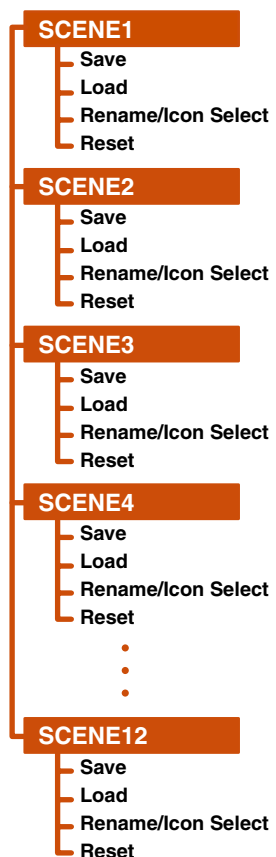

Scene 5 to 12 can also be edited in the Scene menu. Select Scene 5 to 12 in the Scene menu.

Registering SCENE function settings

Save

Registers the settings currently applied to this unit for each SCENE.

Adjusting settings registered with the SCENE function

Load

Loads input sources or sound programs that have been registered with the SCENE function, or specifies whether or not an external component registered as the input source is automatically turned on when a scene is selected.

OK	Loads items indicated with a check mark in "DETAIL."
CANCEL	Cancels settings applied with "DETAIL."
DETAIL	Specifies "SCENE IR" function and displays settings registered with the SCENE function in detail. For more information, see "SCENE IR" and "Detail" at right.

SCENE IR

Specify whether or not a Yamaha BD/DVD player or CD player connected to this unit turns on automatically.

Off	Disables the SCENE IR function.
Yamaha BD/DVD Player1	Select this when a Yamaha BD/DVD player is connected to this unit.
Yamaha BD/DVD Player2	Select this if the player dose not turn on when "Yamaha BD/DVD Player1" is selected.
Yamaha CD Player	Select this when a Yamaha CD player is connected to this unit.

Detail

Display details of settings registered with the SCENE function. Items indicated with a check mark in "Setting" are loaded.

Input	<input checked="" type="checkbox"/>	Displays the "Input" and "Audio Select" settings registered with the SCENE function.
HDMI Output	<input checked="" type="checkbox"/>	Displays the HDMI output jack(s) registered with the SCENE function.
Mode	<input checked="" type="checkbox"/>	Displays the sound program registered with the SCENE function.
Sound	<input checked="" type="checkbox"/>	Displays the "Tone Control," "Adaptive DRC," and "Enhancer" settings registered with the SCENE function.
Surround	<input type="checkbox"/>	Displays the "CINEMA DSP 3D Mode," "Dialogue Lift," and "Extended Surround" settings registered with the SCENE function.
Video	<input type="checkbox"/>	Displays the "Video Processing" and "Video Adjustment" settings registered with the SCENE function.
Volume	<input type="checkbox"/>	Displays the volume setting registered with the SCENE function.
Lipsync	<input type="checkbox"/>	Displays the "Lipsync" and "Delay" settings registered with the SCENE function.
Speaker Setup	<input type="checkbox"/>	Displays the "Setting Pattern" and "PEQ Select" settings registered with the SCENE function.



Changing a scene name and icon

Rename/Icon Select

Changes the scene name and icon displayed on the front panel display or TV screen.

1 Use **[9]Cursor** Δ / ∇ repeatedly to select “Rename/Icon Select” and press **[9]ENTER**.

2 Use **[9]Cursor** \leftarrow / \rightarrow to choose an icon.



3 Press **[9]Cursor** ∇ and **[9]ENTER**.
Editing the name is available.

4 Press **[9]Cursor** Δ / ∇ to select a character, and press **[9]Cursor** \leftarrow / \rightarrow to enter the selected character.

Scene names may consist of up to 20 characters.

5 Repeat step 4 to enter the desired scene name.

6 Confirm the scene name by pressing **[9]ENTER**.

7 Press **[9]Cursor** ∇ to select “OK” and press **[9]ENTER** to register the new input name.

- To cancel the operation without applying changes, select “CANCEL” and then press **[9]ENTER**.
- To clear the characters entered in step 4, select “CLEAR” and press **[9]ENTER**.

Resetting a scene

Reset

Restores all settings for the selected scene to their default values.

Simple registering as the SCENE

1 Use **[4]Input selector** to select the input source you want to register.

2 Set the settings such as sound program, Compressed Music Enhancer, or HDMI OUT you want to register.

The following settings can be registered with a scene 1:

Input, Audio Select, HDMI Output, Sound Program, Pure Direct Mode, Tone Control, Adaptive DRC, Compressed Music Enhancer, CINEMA DSP 3D Mode, Dialogue Lift, Extended Surround, Video Adjustment, Video Processing, Master Volume, Lipsync, Setting Pattern, PEQ Select

3 Press the **[5]SCENE** key until “SET Complete” appears on the front panel display.



Release the key when “SET Complete” is displayed

When changing “SCENE,” also change the external component that the remote control operates ([p. 134](#)).

1: Settings that are not checked in the Scene menu’s “Load” item are not enabled when the corresponding scene key is pressed.

Setting sound program parameters (Sound Program menu)

Sound effects can be adjusted from the Sound Program menu.

Editing sound programs

Adjust sound field elements (sound program parameters) to achieve sound effects suited to the acoustics of audio/video sources or rooms if you are not satisfied with the results achieved with default sound program settings. Follow the procedure described below to adjust sound program parameters.

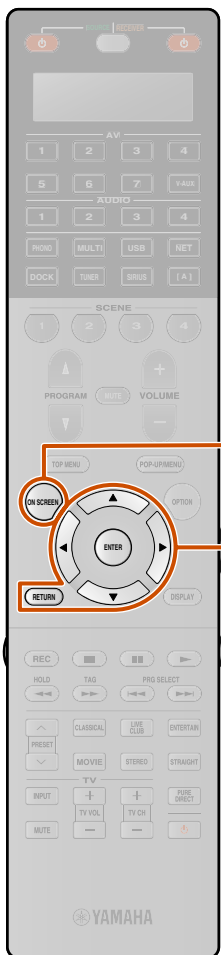

1 Press **[8] ON SCREEN**.

2 Press **[9] Cursor Δ / ▽** to select “Sound Program” and press **[9] ENTER**.

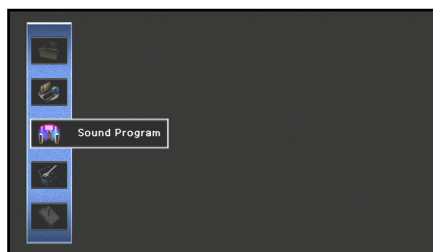

3 Use **[9] Cursor </>** to select a sound program and press **[9] Cursor Δ**.

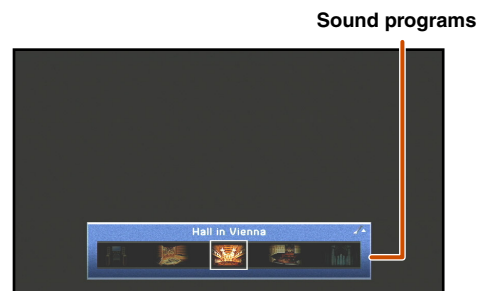

4 Use **[9] Cursor Δ / ▽** to select a parameter and press **[9] ENTER**.

Sound program parameters

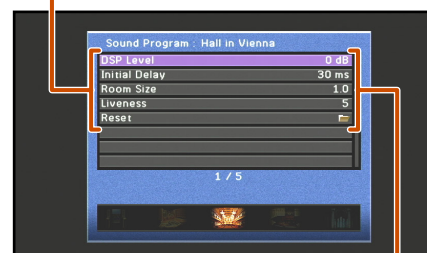

Settings

5 Use **[9] Cursor Δ / ▽ / </>** to adjust the parameter and press **[9] RETURN**. **💡1**

When there are multiple parameters in the selected sound program, repeat steps 4 and 5 to adjust other parameters.

6 Press **[8] ON SCREEN** to close the Sound Program menu.

■ To initialize sound program parameters

To set the parameters of the sound program back to their default settings, use **[9] Cursor Δ / ▽** repeatedly to select “Reset” in step 4 and press **[9] ENTER**. When the following message is displayed, select “OK” and press **[9] ENTER** to initialize.



To cancel initializing, select “CANCEL” and press **[9] ENTER** when the message above is displayed.

💡1: An asterisk (*) appears on the left of the sound field parameter name displayed on the TV when you change the parameter from its default setting.

CINEMA DSP parameters

DSP Level

Change the effect level (level of the sound field effect to be added). You can adjust the level of the sound field effect while checking the sound effect.

Adjustable range	-6 dB to +3 dB
Default setting	0 dB

Adjust "DSP Level" as follows:

- The effect sound is too soft.
→ Increase the effect level.
- There are no differences between effects of the sound programs.
→ Increase the effect level.
- The sound is dull.
→ Reduce the effect level.
- The sound field effect is added too much.
→ Reduce the effect level.

Initial Delay

Surround Initial Delay

Surround Back Initial Delay

Initial delay. Presence, surround, and surround back sound field initial delay. Changes the apparent size of the sound field by adjusting the delay between the direct sound and the first reflection heard by the listener. The smaller the value, the smaller the sound field seems to the listener.

Adjustable range	1 to 99 ms (Initial Delay) 1 to 49 ms (Surround Initial Delay and Surround Back Initial Delay)
------------------	---

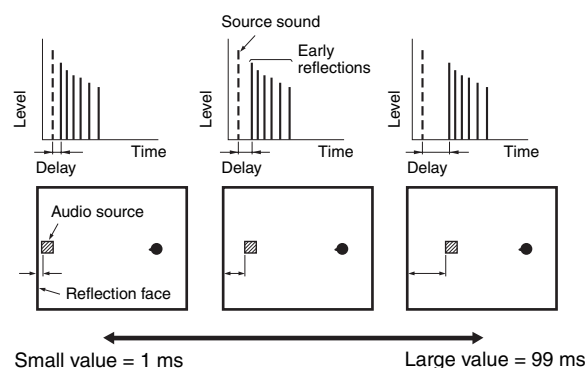

When you adjust the initial delay parameters, we also recommend that you adjust the corresponding room size parameters likewise.

Room Size

Surround Room Size

Surround Back Room Size

Room size. Presence, surround, and surround back room size. Adjusts the apparent size of the sound field. The larger the value, the larger the surround sound field becomes. As the sound is repeatedly reflected around a room, the larger the hall is, the longer the time between the original reflected sound and the subsequent reflections. By controlling the time between the reflected sounds, you can change the apparent size of the virtual venue. Changing this parameter from one to two doubles the apparent length of the room.

Adjustable range	0.1 to 2.0
------------------	------------

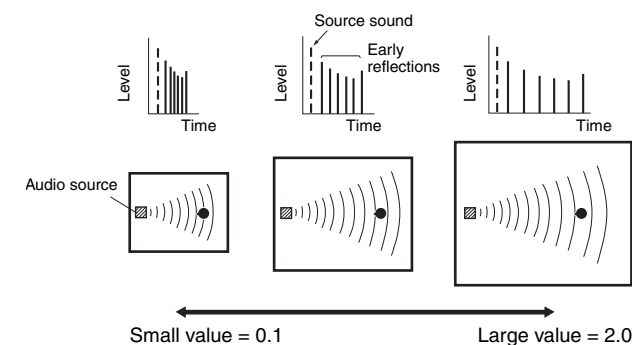

When you adjust the room size parameters, we also recommend that you adjust the corresponding initial delay parameters likewise.

Liveness

Surround Liveness

Surround Back Liveness

Liveness. Surround and surround back liveness. Adjusts the reflectivity of the virtual walls in the hall by changing the rate at which the early reflections decay. The early reflections of an audio source decay much faster in a room with acoustically absorbent wall surfaces than in one which has highly reflective surfaces. A room with acoustically absorbent surfaces is referred to as “dead,” while a room with highly reflective surfaces is referred to as “live.” This parameter lets you adjust the early reflection decay rate and thus the “liveness” of the room.

Adjustable range	0 to 10
-------------------------	---------

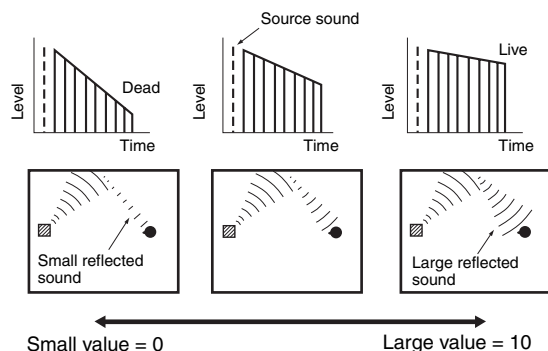

Reverb Time

Reverberation time. Adjusts the amount of time taken for the dense, subsequent reverberation sound to decay by 60 dB at 1 kHz. This changes the apparent size of the acoustic environment over an extremely wide range. Set a longer reverberation time to get more sustaining reverberation sound, and set a shorter time to get articulate sound.

Adjustable range	1.0 to 5.0 s
-------------------------	--------------

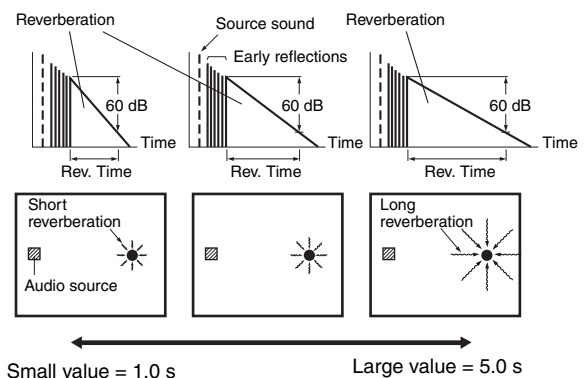

Reverb Delay

Reverberation delay. Adjusts the time difference between the beginning of the direct sound and the beginning of the reverberation sound. The larger the value, the later the reverberation sound begins. A later reverberation sound makes you feel as if you are in a larger acoustic environment.

Adjustable range	0 to 250 ms
-------------------------	-------------

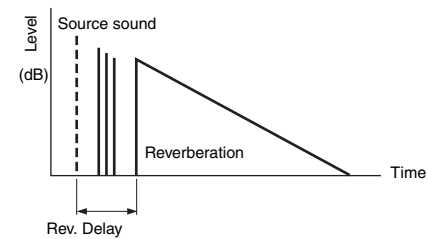

Reverb Level

Reverberation level. Adjusts the volume of the reverberation sound. The larger the value, the stronger the reverberation becomes.

Adjustable range	0 to 100%
-------------------------	-----------

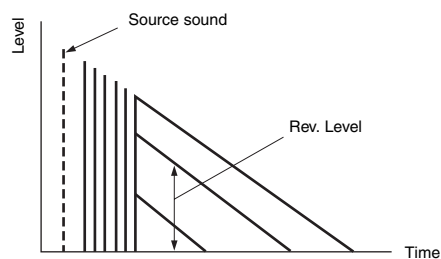

Decode Type

Selects a surround decoder to be used with a sound program in the MOVIE category. 🌟1

PLIIx Movie PLII Movie	Selects the Dolby Pro Logic IIx Movie (or Dolby Pro Logic II Movie) decoder.
Neo:6 Cinema	Selects the Neo:6 (Cinema) decoder.

Parameters usable in certain sound programs

2ch Stereo only

Direct

Automatically bypasses the DSP circuit and tone control circuit depending on the condition of tone control etc., when an analog audio source is played back. You can enjoy a higher quality sound.

Auto (Default)	Outputs sound by bypassing the DSP circuit and tone control circuit when both tone controls of “Bass” and “Treble” are set to 0 dB.
Off	Does not bypass the DSP circuit and tone control circuit.

7ch Stereo only

Center Level

Adjusts the center channel volume. 🌟2

Adjustable range	0 to 100%
Default setting	100%

Surround L Level

Adjusts the volume of the surround L channel. 🌟2

Adjustable range	0 to 100%
Default setting	100%

Surround R Level

Adjusts the volume of the surround R channel. 🌟2

Adjustable range	0 to 100%
Default setting	100%

Surround Back L Level

Adjusts the volume of the surround back L channel. 🌟2

Adjustable range	0 to 100%
Default setting	35% (7.1-channel configuration) 50% (6.1-channel configuration)

Surround Back R Level

Adjusts the volume of the surround back R channel. 🌟2

Adjustable range	0 to 100%
Default setting	35% (7.1-channel configuration) 50% (6.1-channel configuration)

Front Presence L Level

Adjusts the volume of the front presence L channel. 🌟2

Adjustable range	0 to 100%
Default setting	33%

🌟1: Surround decoders cannot be changed when used with the following MOVIE and ENTERTAINMENT sound programs.

- Mono Movie
- Sports
- Action Game
- Roleplaying Game

🌟2: Not displayed when speakers are set to be inactive.

Front Presence R Level



Adjusts the volume of the front presence R channel. 

Adjustable range	0 to 100%
Default setting	33%

Parameters usable in surround decoder

Decode Type

Selects a surround decoder.

Pro Logic	Reproduces sound using the Dolby Pro Logic decoder. This is suitable for all kinds of audio sources.
PLIIx Movie / PLII Movie	Reproduces sound using the Dolby Pro Logic IIx (or Dolby Pro Logic II) decoder. This is suitable for movies. 
PLIIx Music / PLII Music	Reproduces sound using the Dolby Pro Logic IIx (or Dolby Pro Logic II) decoder. This is suitable for music. 
PLIIx Game / PLII Game	Reproduces sound using the Dolby Pro Logic IIx (or Dolby Pro Logic II) decoder. This is suitable for games. 
Neo:6 Cinema	Reproduces sound using the DTS Neo:6 decoder. This is suitable for movies.
Neo:6 Music	Reproduces sound using the DTS Neo:6 decoder. This is suitable for music.

Dolby PLIIx Music and Dolby PLII Music only

Panorama

Adjusts the soundscape of the front sound field. Sends front left/right channels sounds to the surround speakers as well as the front speakers for a wraparound effect.

Off (Default)	Disables the effect.
On	Enables the effect.

Center Width

Spreads the center channel sound to the front left and right speakers to suit your needs or preferences. Set this parameter to 0 for outputting the center sound from the center speaker only, or to 7 for outputting it from the front left/right speaker only.

Adjustable range	0 to 7
Default setting	3

Dimension

Adjusts the difference in level between the front sound field and the surround sound field. You can adjust the difference in level created by the software being played back to obtain the preferred sound balance. The surround sound gets stronger as you make the value more negative, and the front sound gets stronger as you make the value more positive.

Adjustable range	-3 to +3
Default setting	0

When Neo:6 Music is selected

Center Image

Adjusts the front left and right channel output relative to the center channel to make the center channel more or less dominant as necessary.

Adjustable range	0.0 to 1.0
Default setting	0.3

 1: Not displayed when speakers are set to be inactive.

 2: You cannot select the Dolby Pro Logic IIx decoder in the following conditions:

- When "Surround Back" is set to "None" ([**p. 117](#)).
- When headphones are connected.

Setting various functions (Setup menu)

Various settings, such as speaker volume or HDMI functions, can be changed from the Setup menu.

Operating the Setup menu

1 Press **[8] ON SCREEN**.

2 Press **[9] Cursor Δ / ▽** repeatedly to select "Setup" and press **[9] ENTER**.

3 Use **[9] Cursor < / >** to select a menu and press **[9] ENTER**.

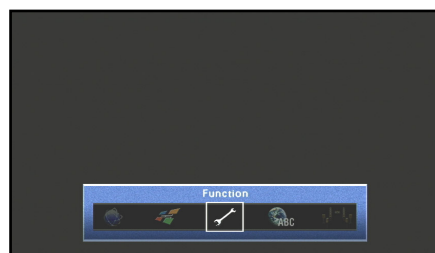
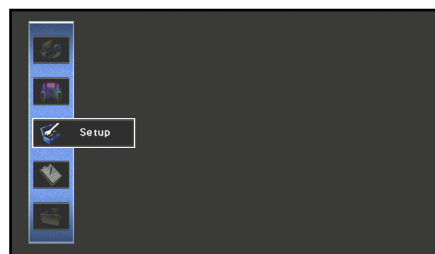
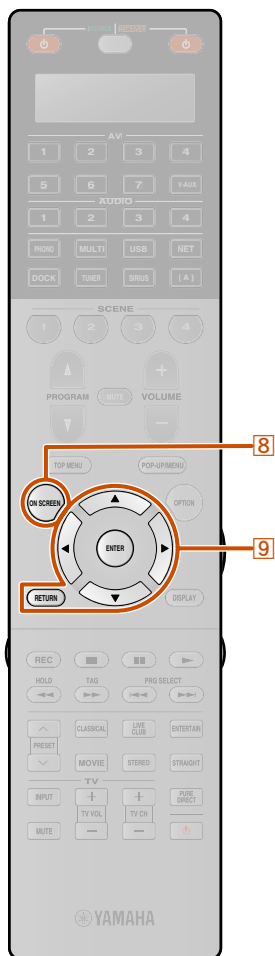

Setup menus

Speaker	Adjusts parameters for speakers, such as speaker status, and volume adjustment for each speaker (esp. 115).
Sound	Sets functions related to audio output, such as adjustment of maximum volume and of dynamic range (esp. 119).
Video	Sets video output functions, such as video conversion settings (resolution and aspect ratio) (esp. 121).
HDMI	Sets HDMI functions, such as the HDMI Control function and output destination for HDMI sound (esp. 123).
Network	Sets network status, such as IP Address or MAC Address Filter (esp. 125).
Multi Zone	Sets multi-zone functions, such as volume adjustment for speakers in the secondary zone (esp. 126).
Function	Sets functions such as the Auto Power Down function, that make the unit easier to use (esp. 128).
Language	Selects the language of the menus and messages displayed on TV screen (esp. 131).

4 Use **[9] Cursor Δ / ▽** to select an item and press **[9] ENTER**.



When the selected item contains detailed ones, use **[9] Cursor Δ / ▽** to select the detailed item and press **[9] ENTER**.

5 Use **[9] Cursor Δ / ▽ / < / >** to adjust the setting.

Pressing **[9] RETURN** displays the previous menu. Repeat steps 4 to 5 to adjust multiple settings.

6 Press **[8] ON SCREEN** to close the menu.

Setup menu

Speaker

- Auto Setup
- Manual Setup

Sound

- Lipsync
- Dynamic Range
- Max Volume
- Initial Volume
- Pure Direct Mode
- Adaptive DSP Level

Video

- Analog to Analog Conversion Processing

HDMI

- HDMI Control
- Control Select
- ARC (Audio Return Channel)
- TV Audio Input
- Audio Output
- Standby Through

Network

- IP Address
- Network Standby
- MAC Address Filter

Multi Zone

- Zone2 Set
- Zone3 Set
- Digital Out Assign
- Monitor Out Assign
- Party Mode Set
- Zone Scene Rename
- Zone Rename

Function

- Auto Power Down
- Input Assignment
- Display Set
- Trigger Output1
- Trigger Output2
- Memory Guard

Language

Manages settings for speakers



Speaker setup items

Auto Setup	Optimizes the speaker configuration automatically.
Manual Setup	Manually adjusts parameters for speakers.

Automatic speaker setup

Auto Setup

Optimizes the speaker configuration automatically using YPAO (p. 43).

Manual speaker setup

Manual Setup

The following parameters can be specified manually.

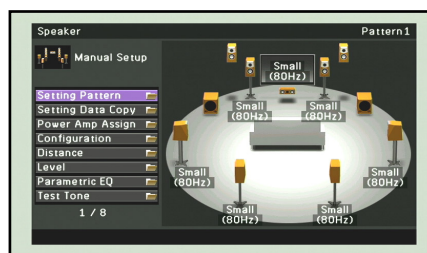

Setting Pattern	Registers two speaker setting patterns and switches between the two.
Setting Data Copy	Copies "Setting Pattern" data.
Power Amp Assign	Adds the extra speakers to the 7.1-channel speaker connection.
Configuration	Manually manages speaker configuration, such as speaker size (sound production capacity), and bass audio processing.
Distance	Manually adjusts the output of each speaker based on distance to the listening position.
Level	Manually adjusts the volume of each speaker.
Parametric EQ	Selects an equalizer to adjust speaker output characteristics.
Test Tone	Generates test tones.

Setting Pattern

Registers two patterns for "Power Amp Assign," "Configuration," "Level," "Distance," and "Parametric EQ" settings and switches between the two setting patterns.

When the automatic speaker setup (YPAO) is performed, the result of measurement is registered on the currently selected Setting Pattern.

Setting Data Copy

Copies "Setting Pattern" data in the specified direction.

Pattern1 ▶ 2	Copies Pattern1 settings to Pattern2.
Pattern2 ▶ 1	Copies Pattern2 settings to Pattern1.

Power Amp Assign

In addition to the 7.1-channel speaker connection, various speaker configurations are possible using the presence speakers connection, bi-amp connection or multi-zone function (p. 20, p. 21).

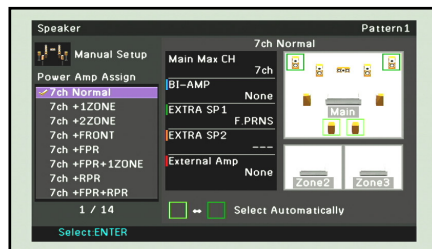

7ch Normal	Enables the normal 7-channel speakers and front presence speakers (p. 16).
7ch +1ZONE	Enables the normal 7-channel speakers and zone2 or zone3 speakers (p. 18). The Zone assigned to EXTRA SP1 can be selected from Zone2 or Zone3.
7ch +2ZONE	Enables the normal 7-channel, Zone2 and Zone3 speakers (p. 19). The Zone assigned to EXTRA SP1/EXTRA SP2 can be selected from Zone2 or Zone3.
7ch +FRONT	Enables the normal 7-channel speakers and external front speakers (p. 24).
7ch +FPR	Enables the normal 7-channel speakers and external front presence speakers (p. 24).
7ch +FPR+1ZONE	Enables the normal 7-channel speakers, external front presence speakers and zone speakers (p. 25). The Zone assigned to EXTRA SP1 can be selected from Zone2 or Zone3.
7ch +RPR	Enables the normal 7-channel speakers and external rear presence speakers (p. 25).

7ch +FPR+RPR	Enables the normal 7-channel speakers, and external front and rear presence speakers (p. 25).
7ch +FPR+RPR+1ZONE	Enables the normal 7-channel speakers, external front and rear presence speakers and zone speakers (p. 26). The Zone assigned to EXTRA SP1 can be selected from Zone2 or Zone3.
5chBI-AMP	Enables the bi-amp connection (p. 18).
5chBI-AMP +FPR	Enables the bi-amp connection and external presence speakers (p. 26).
5chBI-AMP +SB	Enables the bi-amp connection and external surround back speakers (p. 26).
5chBI-AMP +SB+FPR	Enables the bi-amp connection, external surround back and front presence speakers (p. 27).
5chBI-AMP +FPR+RPR	Enables the bi-amp connection, external front and rear presence speakers (p. 27).

Configuration

Displays the speakers connected to this unit or adjusts the output characteristics of the speakers.

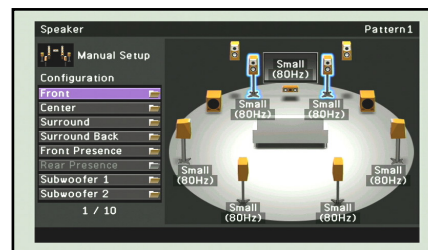

In the "Configuration," you can select the speaker size characteristic (Large or Small). Select the size (sound reproduction capacity) that matches your speakers.

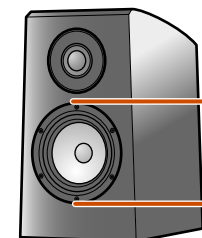

Woofer diameter

- 6-1/4 in (16 cm) or larger → Large
- 6-1/4 in (16 cm) or smaller → Small

When speaker size is set to "Small," low-frequency components of the speakers that you configured are produced from the subwoofer (or from the front speakers if there is no subwoofer).

Front

Selects the size (sound reproduction capacity) of the front speakers. 1

Large	Select this for large speakers. The front speakers will produce all of the front channel frequency components.
Small (Default)	Select this for small speakers. The subwoofer will produce front channel low-frequency components. The crossover frequency can be selected from 40Hz, 60Hz, 80Hz (Default), 90Hz, 100Hz, 110Hz, 120Hz, 160Hz, or 200Hz. All frequencies below the selected frequency will be sent to the subwoofer.

1: When "Subwoofer1" and "Subwoofer2" are set to "None," you can only choose "Large." If the front speaker setting is "Small" and you change "Subwoofer1" and "Subwoofer2" to "None," it will automatically change to "Large."

Center

Selects the size of the center speaker.

Large	Select this when a large center speaker is connected.
Small (Default)	Select this when a small center speaker is connected. The crossover frequency can be selected from 40Hz, 60Hz, 80Hz (Default) , 90Hz, 100Hz, 110Hz, 120Hz, 160Hz, or 200Hz when selecting this. All frequencies below the selected frequency will be sent to the subwoofer.
None	Select this when there is no center speaker. The front speakers will produce center channel audio.

Surround

Selects the size of the surround speakers.

Large	Select this when the surround speakers are large.
Small (Default)	Select this when the surround speakers are small. The crossover frequency can be selected from 40Hz, 60Hz, 80Hz (Default) , 90Hz, 100Hz, 110Hz, 120Hz, 160Hz, or 200Hz when selecting this. All frequencies below the selected frequency will be sent to the subwoofer.
None	Select this when no surround speakers are connected. The front speakers will produce surround channel audio signals.

- When set to “None,” no sound is produced from the surround back speaker even if that speaker is connected.
- When set to “None,” the sound programs will change to Virtual CINEMA DSP mode.

Surround Back

Selects the size of the surround back speakers.

Largex1	Select when one large surround back speaker is connected.
Largex2	Select when two large surround back speakers are connected.
Smallx1	Select when one small surround back speaker is connected.
Smallx2 (Default)	Select when two small surround back speakers are connected.
None	Select this when no surround back speakers are connected.

- When there are no surround speakers are connected, the setting will automatically change to “None.”
- You can set surround back audio signals, including from the playback source, to be mixed down and produced from a single speaker (6.1-channel layout) or produced from left and right surround speakers (5.1-channel layout).

Front Presence

Specify connection of front presence speakers.

Use (Default)	Select this when front presence speakers are connected.
None	Select this when front presence speakers are not connected.

Rear Presence

Specify connection of rear presence speakers.

Use (Default)	Select this when rear presence speakers are connected.
None	Select this when rear presence speakers are not connected.

Subwoofer1 / Subwoofer2

Confirms the subwoofer.

Use (Default)	Select this when subwoofer is connected. During playback, the subwoofer will produce audio from the LFE (low-frequency effect) channel and bass audio from other channels.  1 Select the phase of the subwoofer from the following items if the bass audio is lacking or unclear. Normal (Default) Does not change the subwoofer phase. Reverse Reverses the subwoofer phase.
None	Select this when subwoofer is not connected. The front speakers will produce audio from the LFE (low-frequency effect) channel and bass frequency audio from other channels when both “Subwoofer1” and “Subwoofer2” are set to “None.”

SWFR Layout

Select a layout of two subwoofers connected to this unit.

Left + Right	Select when two subwoofers are arranged with one to the left and one to the right of this unit.
Front + Rear	Select when two subwoofers are arranged with one in front of and one behind this unit.
Monaural x2 (Default)	Select when two subwoofers are arranged in a manner not suited to either or the other setting options.

 1: Enabling “Extra Bass” allows both the subwoofer and the front speakers to produce bass audio.

Extra Bass

Allows the front channel low-frequency components to be produced exclusively by the subwoofer, or by both the subwoofer and the front speakers.

Off (Default)	Depending on the size of the front speakers, either the front speakers or the subwoofer produce the front channel low-frequency components.
On	The subwoofer and the front speakers produce the front channel low-frequency components.

When “Subwoofer1” and “Subwoofer2” are set to “None” or “Front” is set to “Small,” “Extra Bass” is disabled.

Distance

Adjusts the timing at which the speakers produce audio so that sounds from the speakers reach the listening position at the same time.

Selecting adjustment units

Use **[9]Cursor Δ / ▽** to select the unit for distance (meters or feet), and press **[9]ENTER**.

Setting distances for each speaker

Use **[9]Cursor Δ / ▽** to select the speaker you want to configure, and press **[9]ENTER**.

Then use **[9]Cursor < / >** to set the distance from the speaker to your listening position.

Adjustable range	1.0 ft. to 80.0 ft. (0.30 m to 24.00 m)
Default setting	10.0 ft. (3.00 m)
Adjustment increments	0.2 ft. (0.05 m)

Level

Separately adjusts the volume of each speaker.

Use **[9]Cursor Δ / ▽** to select the desired speaker, and press

[9]ENTER.

Then use **[9]Cursor < / >** to adjust the volume for the selected speaker.

Adjustable range	-10.0 dB to +10.0 dB
Default setting	0.0 dB
Adjustment increments	0.5 dB

You can also adjust the volume of each speaker by using

[28]LEVEL.

Press **[28]LEVEL** and use **[9]Cursor Δ / ▽** to select the desired speaker. Then use **[9]Cursor Δ / ▽** to adjust the volume for the selected speaker.

Parametric EQ

Adjusts sound quality of tone using a parametric equalizer.

PEQ Select

Select an equalizer type.

Manual	Manually adjust equalizer sound.
Flat	Adjust individual speakers to achieve the same characteristics. Select this option if speakers offer the same quality.
Front	Adjust individual speakers to achieve the same characteristics as the front left and right speakers. Select this option if front left and right speakers offer significantly greater quality than other speakers.
Natural	Adjust all speakers to achieve a natural sound. Select this if high-frequency sounds seem too strong when “PEQ Select” is set to “Flat.”
Through (Default)	Disable the equalizer.

PEQ Data Copy

Select 1 of the 3 parametric equalizer types acquired with automatic setup and manually copy that information to the manual adjustments.

Flat ▶ Manual	Copy the “Flat” parametric equalizer information acquired with automatic setup.
Front ▶ Manual	Copy the “Front” parametric equalizer information acquired with automatic setup.
Natural ▶ Manual	Copy the “Natural” parametric equalizer information acquired with automatic setup.



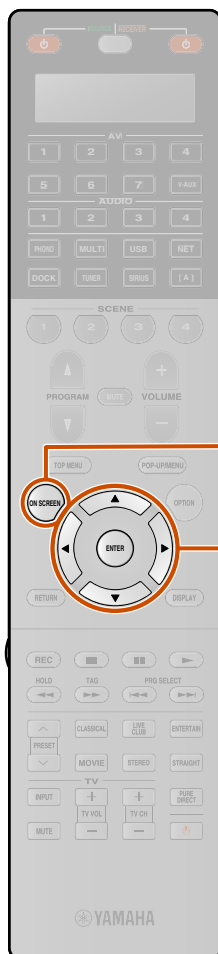

Front L / Front R / Center / Surround L / Surround R / Surround Back L / Surround Back R / Front Presence L / Front Presence R / Rear Presence L / Rear Presence R / Subwoofer1 / Subwoofer2

The parametric equalizer can be used to manually adjust sound quality for individual speakers.

Set "PEQ Select" to "Manual" and use "PEQ Data Copy" to copy information acquired with automatic setup. This information can be used as a basis for performing manual adjustments.

1 Use **[9]Cursor Δ / ▽** repeatedly to select "Band / Gain," "Freq. / Gain," or "Q / Gain" and press **[9]ENTER**.

2 Use **[9]Cursor < / >** repeatedly to adjust the parameter and use **[9]Cursor Δ / ▽** repeatedly to adjust the gain.

3 Press **[9]ENTER** to exit the edit window.

4 Repeat steps 1 to 3 to configure other parameters.

To reset all parameter settings for the selected speaker, select "Yes" in "Reset" and press **[9]ENTER**.

5 Press **[8]ON SCREEN** to close the menu.

Test Tone

Turns the test tone generator on or off.

Off (Default)	Does not generate test tones.
On	Generates test tones. While "On" is selected, test tones are produced constantly.

You can use the test tone in a variety of circumstances. For example, you can adjust the volume balance settings for each speaker, or whenever you adjust the settings on the internal parametric equalizer, you can listen to the actual effect while operating this unit. Turn the test tone off when you have finished making adjustments.

Setting the audio output function of this unit



Sound setup items

Lipsync	Adjusts the delay between video and audio output.
Dynamic Range	Selects the dynamic range adjustment method for Dolby Digital and DTS playback.
Max Volume	Sets the maximum volume for this receiver.
Initial Volume	Sets the initial volume for when this receiver is turned on.
Pure Direct Mode	Selects whether or not this unit outputs video signal in Pure Direct Mode.
Adaptive DSP Level	Adjusts the level of DSP effect in conjunction with the volume level.

Synchronizing audio/video output

Lipsync

Adjusts the delay between audio and video output (Lipsync function).

Selects a compensation method for the delay between audio and video output.

Auto (Default)	When connecting to a TV via HDMI, automatically adjusts output timing if the TV supports an automatic lipsync function.
Manual	Manually adjusts the correction time. Select this when the monitor does not support the automatic lipsync function.

Adjustable range	0 ms to 250 ms
Default setting	0 ms
Adjustment increments	1 ms

Auto-adjusting Dolby Digital and DTS dynamic range

Dynamic Range

Selects the dynamic range adjustment method for audio bitstream (Dolby Digital and DTS) signal playback.

MAX (Default)	Produces audio without adjusting the dynamic range.
STD	Adjusts the dynamic range for optimum volume for regular home use.
MIN/AUTO	(MIN) Sets the dynamic range suitable for low volume or a quiet environment, such as at night, for bitstream signals except for Dolby TrueHD signals. (AUTO) Adjusts the dynamic range for Dolby TrueHD signals based on input signal information.

Setting the maximum volume

Max Volume

Specify the maximum volume level so that sound is not too loud. The default setting of +16.5 dB produces the highest volume.

Adjustable range	-30.0 dB to +16.5 dB (maximum volume)
Default setting	+16.5 dB
Adjustment increments	5.0 dB

Setting the startup volume

Initial Volume

Sets the initial volume for when this receiver is turned on. When this parameter is set to "Off," the volume is set at the level when the receiver last entered standby mode.

Adjustable range	Off, Mute, -80.0 dB to +16.5 dB
Default setting	Off
Adjustment increments	0.5 dB

Video signal output in Pure Direct Mode

Pure Direct Mode

Selects whether or not this unit outputs video signal in Pure Direct Mode.

Auto (Default)	Automatically output video signal when the input source equipping video signal input jacks or content window is selected. If no video signal is input, only the wall paper is displayed.
Video Off	Does not output video signal including the wall paper.

1: The setting is effective at the HDMI OUT jack selected by using HDMI OUT.

2: When you set "Max Volume" at a lower level than "Initial Volume," "Max Volume" has priority.

Adjusting DSP effect and volume level

Adaptive DSP Level

Automatically adjust the level of DSP effect in conjunction with the volume level.

Off	Disables automatic adjustment of the level of DSP effect.
On (Default)	Adjusts the degree of DSP effect in conjunction with volume level. The higher the volume level, the less the DSP effect applied. The lower the volume level, the greater the DSP effect applied. This feature also corrects sound effect according to the result of automatic measurement.

Setting this unit's video output function

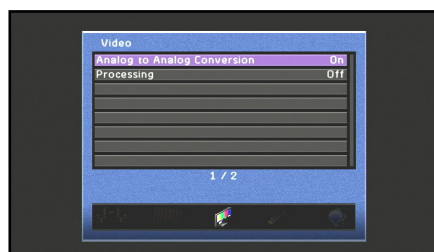

Video setup items

Analog to Analog Conversion	Enable or disable video conversion between analog video jacks.
Processing	Enable or disable adjustment of resolution, aspect ratio and video signal correction for video signal converted to HDMI video.

Analog-to-analog video conversion

Analog to Analog Conversion

Enables or disables video conversion between analog video jacks.

Off	Disables video conversion between analog video jacks.
On (Default)	Enables video conversion between analog video jacks.

- Analog-to-HDMI video conversion is always possible unless video signals are being input at the HDMI input jacks or 1080p-resolution analog video signals are being input (p. 167).
- This unit does not convert 480 line video signals and 576 line video signals interchangeably.
- 480p-, 576p-, 1080i- and 720p-resolution video signals can not be output at the S-video and video jacks of MON.OUT/ZONE OUT (p. 167).
- The converted video signals are only output at the MONITOR OUT jacks.
- When composite video or S-video signals from a VCR are converted into component video signals, the picture quality may suffer depending on your VCR.
- Unconventional signals input at the composite video or S-video jacks cannot be converted or may be output abnormally. In such cases, set "Analog to Analog Conversion" to "Off."

Adjusting video with conversion of video signal to HDMI

Processing

Adjust video with conversion of video input to HDMI video.

Off (Default)	Video are not adjusted with processing.
On	Video are adjusted with processing.

Resolution

Auto (Default)	Automatic upscaling in accordance with TV resolution.
480p (576p)	Upscaling to 480p (576p).
720p	Upscaling to 720p.
1080i	Upscaling to 1080i.
1080p	Upscaling to 1080p.
Through	No upscaling.

- When a TV is connected to this unit via the HDMI jack, this unit automatically detects a resolution that the TV supports. Only the detected resolution can be selected.
- If this unit cannot detect the resolution that the TV supports, set "MONITOR CHECK" in the Advanced Setup menu to "SKIP" (p. 146) and try again.

 1 : This item can be set when set "Processing" to "On."

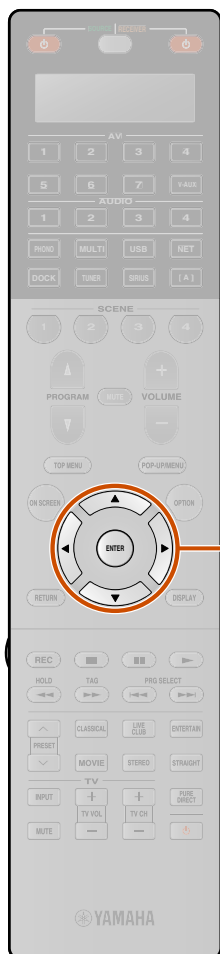

Aspect 1

Specifies the method used to convert video signal with a 4:3 aspect ratio (480i/576i/480p/576p) to the 16:9 aspect ratio (720p/1080i/1080p).

Through (Default)	Does not adjust the aspect ratio of video signal sources.
16:9 Normal	Transmits 4:3 aspect ratio video signals to a 16:9 TV with black bands on either side of the screen.
Smart Zoom	Adjusts video images with an aspect ratio of 4:3 to fit video monitors with an aspect ratio of 16:9. When "Aspect" is set to "Smart Zoom," the edges of video images may be distorted with display on the video monitor.

Adjustment 1

Adjusts video quality. The preset feature can also be used to save up to six preferred video quality settings.

1 Press  **9**  to select the preset and press  **ENTER**.

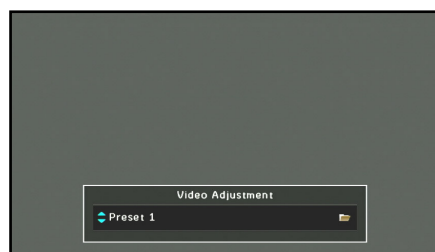

2 Press  **9**  to select the item you want to adjust.

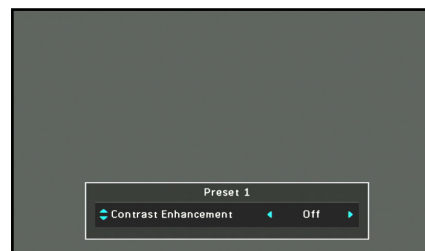

3 Press  **9**  to adjust the following parameters and press  **ENTER**.

The settings are applied to the selected preset.

Contrast Enhancement	When this item is set to "Auto," image contrast is automatically enhanced. "Off" (Default) disables the contrast enhancement function.
Resolution Enhancement	When this item is set to "Auto," image resolution is automatically enhanced. "Off" (Default) disables the resolution enhancement function. When this item is set to "Manual," the control range for the following items can be adjusted manually. The setting of this item interlocks with the settings of the following items. – Detail Enhancement Enhances the detail of images. Control range: 0 (default) to 50 – Edge Enhancement Enhances the edges of images. Control range: 0 (default) to 50

Noise Reduction	When this item is set to "Auto," image noise is automatically reduced. "Manual" allows you to enhance image noise manually. "Off" (Default) disables the noise reduction function. The setting of this item interlock with the settings of the following items. When this item is set to "Manual," the setting levels of the following items can be selected. – Mosquito NR Reduces the flicker noise come out at the edges of image (mosquito noise). Settings: Low/Medium/High – Block NR Reduces the block noises of image. Block noise comes out frequently when playing back the low bit-rate video. Settings: Low/Medium/High – Temporal NR Reduces the temporal noise of image such as film-grain noise or random noise of analog video signals. Settings: Low/Medium/High
Brightness	Adjusts image brightness. Control range: -100 to +100 Initial setting: 0
Contrast	Adjusts image contrast. Control range: -100 to +100 Initial setting: 0
Saturation	Adjusts image saturation. Control range: -100 to +100 Initial setting: 0

 1: This item can be set when set "Processing" to "On."

Setting HDMI functions



HDMI setup items

HDMI Control	Turns the HDMI Control on or off.
Control Select	Choose an HDMI OUT jack on which HDMI Control function is enabled.
ARC (Audio Return Channel)	Turns the Audio Return Channel function on or off.
TV Audio Input	Chooses automatically selected audio input in conjunction with TV operation when the HDMI Control is turned on.
Audio Output	Specifies whether or not audio signal is output through this unit and a TV connected via the HDMI OUT 1-2 jacks.
Standby Through	Turns the Standby Through function on or off.

1: This item appears depending on “HDMI Control.”

Receiver operation via TV (HDMI Control)

HDMI Control

Set the HDMI Control function to “On” to operate devices connected via HDMI. If the TV or other external components support HDMI Control (e.g., Panasonic VIERA Link), you can use the remote controls of those devices to operate some of this unit’s functions, and to synchronize this unit with the operation of those devices.

Refer to “Using the HDMI Control function” ([p. 148](#)) for setting instructions.

Off (Default)	Sets HDMI Control to “Off.”
On	Sets HDMI Control to “On.”

If this unit is connected to HDMI devices that do not support the HDMI Control function, these functions will not operate.

Selecting an HDMI OUT jack for the HDMI Control function

Control Select

Select the HDMI OUT jack that utilizes the HDMI Control function.

Refer to “Using the HDMI Control function” ([p. 148](#)) for setting instructions.

OUT1(TV1)	Applies the HDMI Control function for the HDMI OUT 1 jack.
OUT2(TV2)	Applies the HDMI Control function for the HDMI OUT 2 jack.

We recommend to unplug and re-plug the power cable of this unit and the TV when changing the Control Select.

2: When the HDMI Control is “On,” the Standby Through function is automatically enabled. When this unit enters standby mode, the audio and video signals from the last-selected HDMI input source will continue to be transmitted to the TV. The HDMI input source can only be changed using the remote control.

Listening to TV audio via single HDMI cable (Audio Return Channel)

ARC (Audio Return Channel)

You can enable or disable the Audio Return Channel function. When using a TV that supports Audio Return Channel function and the function is enabled, the TV’s audio output is transmitted to this unit via an HDMI cable.

The TV audio input to this unit is regarded as the input source selected in “TV Audio Input.”

By means of this function, you do not need to connect the TV’s audio output (digital audio output or analog audio output) to the unit.

Off (Default)	Sets the Audio Return Channel to “Off.”
On	Sets the Audio Return Channel to “On.”

When the TV audio is input to the unit using Audio Return Channel, “TV” is displayed on the front panel display.



- “ARC (Audio Return Channel)” is enabled only for the HDMI OUT 1 or 2 jack selected with “Control Select.”
- Refer to “Single HDMI cable input to TV audio with Audio Return Channel function” ([p. 150](#)) for setting instructions.

3: While the Audio Return Channel function is on, the jack selected for the input source cannot be used.

Selecting an input source to assign audio input for the TV

TV Audio Input

Select the input source that receives audio signals from TV while the HDMI Control function is on.

When the TV is set to output sounds via this unit, the TV audio input is automatically selected to the input source assigned here.  1

TV1

Audio input	AUDIO1-4
Default setting	AUDIO1

TV2

Audio input	AUDIO1-4
Default setting	AUDIO3

- “TV Audio Input” is enabled only for the HDMI OUT 1 or 2 jack selected with “Control Select.”
- Refer to “Switching the input source on this unit automatically when listening to TV audio” ([p. 149](#)) for instructions.

Specify whether or not audio signal is output through this unit and a TV connected via the HDMI OUT jack

Audio Output

Choose whether audio from an external component, such as a BD/DVD player, connected via HDMI is played back through this unit or through a TV.

Amp

Specify whether or not audio signal is output through this unit.

Off	Audio is not output through this unit.
On (Default)	Audio is output through this unit. When this setting is selected, audio from the external component is output in a format compatible with this unit.

OUT1

Specify whether or not audio signal is output through a TV connected via the HDMI OUT 1 jack.

Off (Default)	Audio is not output through a TV connected via the HDMI OUT 1 jack.
On	Outputs audio through a TV connected via the HDMI OUT 1 jack. When this setting is selected, audio from the external component is output in a format compatible with the TV.

OUT2

Specify whether or not audio signal is output through a TV connected via the HDMI OUT 2 jack.

Off (Default)	Audio is not output through a TV connected via the HDMI OUT 2 jack.
On	Outputs audio through a TV connected via the HDMI OUT 2 jack. When this setting is selected, audio from the external component is output in a format compatible with the TV.

When “HDMI Control” is set to “On,” the settings of “Amp” and the HDMI OUT jack (OUT1 or OUT2) selected with “Control Select” are interlocked with “HDMI Control.”

Transmitting HDMI audio/video to the TV during standby mode (Standby Through)

Standby Through

This function allows audio/video signals from HDMI inputs to continue to be transmitted to a TV when this unit is in standby mode.

When the Standby Through function is “On,” audio/video signals continue to be output to the TV from the last HDMI input source before this unit enters standby mode. The HDMI input source can be selected using **AV1-7** or **V-AUX** in standby mode.

Off (Default)	Sets Standby Through to “Off.”
On	Transmits audio/video signals from the selected HDMI input source to the TV.

- When “HDMI Control” is “On,” Standby Through function is automatically enabled and “Standby Through” is not displayed.
- When the Standby Through function is on, the HDMI Through/iPod Charge indicator on the front panel lights during the standby mode. This unit consumes 2 to 5 W of power.
- Input source can be selected during Standby Through.

 1: While the Audio Return Channel function is on, the jack selected for the input source cannot be used.

Adjusting this unit's network parameters

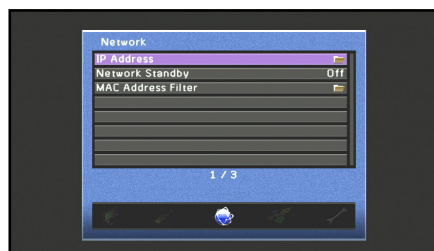

Network setup items

IP Address	Selects whether this unit acquires network parameters (IP address, etc.) from the network's DHCP server automatically, or whether these parameters are specified manually.
Network Standby	Selects whether or not commands are accepted over the network when this unit is in standby mode.
MAC Address Filter	Sets the MAC address filter to restrict network access to this unit.

Specifying network parameters (IP address, etc.)

IP Address

Selects whether or not this unit automatically acquires network parameters (IP address, subnet mask, default gateway, primary DNS server and secondary DNS server) from the a network device such as a router equipped with DHCP function.

DHCP

Off	Select this setting to specify IP address manually.
On (Default)	Select this setting to acquire IP address from the network's DHCP server automatically.

Manual Setup

IP Address	Specifies the IP address assigned to this unit. An IP address used by another device on the same network may not be used.
Subnet Mask	Specifies the subnet mask assigned to this unit.
Default Gateway	Specifies the IP address of the default gateway.
DNS Server (Primary)/DNS Server (Secondary)	Specifies the IP addresses of the primary and secondary Domain Name System (DNS) servers.

If the network has only one DNS address, enter that address in "DNS Server (Primary)." If the network has two or more DNS addresses, enter one of the addresses in "DNS Server (Primary)" and the other in "DNS Server (Secondary)."

Turning this unit on by the command over the network when in the standby mode

Network Standby

Selects whether or not to turn this unit on by the command over the network when in the standby mode.

Off (Default)	Disables to turn this unit on by the command over the network.
On	Enables to turn this unit on by the command over the network.

When "Network Standby" is set to "On," this unit can be turned on by the command over the network during the standby mode with the power consumption of about only 5 W.

Setting the MAC Address Filter

MAC Address Filter

Sets the MAC address filter to restrict access to this unit in LAN.

Mode

Off (Default)	Disables the MAC address filter function.
On	Permits access to this unit only by network devices with specified MAC addresses.

Address Setup

Specifies the MAC addresses of network devices permitted to access to this unit when "MAC Address Filter" is set to "On."

Setting this unit's multi-zone function

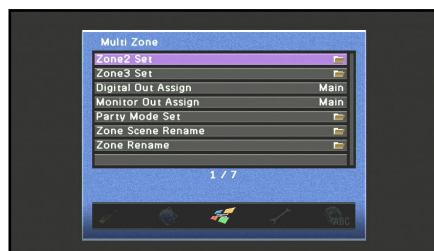

Multi Zone setup items

Zone2 Set	Sets the Zone2 functions.
Zone3 Set	Sets the Zone3 functions.
Digital Out Assign	Selects a zone to which the digital audio signals are output from AV OUT/ZONE4 jacks.
Monitor Out Assign	Displays the menus of Zone2, Zone3 or Zone4 on the TV monitor.
Party Mode Set	Enable or disable the party mode function.
Zone Scene Rename	Changes the scene names of Zone.
Zone Rename	Changes the name of Zone2, Zone3 or Zone4.

Adjusting Zone2 or Zone3 volume

Zone2 Set

Zone3 Set

Volume

Selects whether or not volume level adjustment of Zone2 or Zone3 speakers is enabled.

Fixed	Disables volume level adjustment of Zone2 or Zone3 speakers.
Variable (Default)	Enables volume level adjustment of Zone2 or Zone3 speakers.

When setting the Power Amp Assign function, "Volume" is automatically set to "Variable." Refer "Speaker layout" (p. 16) for details on the Power Amp Assign function.

Max Volume

Specify the maximum volume level in Zone2 or Zone3 so that sound is not too loud.

Adjustable range	-30.0 dB to +16.5 dB (maximum volume)
Default setting	+16.5 dB
Adjustment increments	5.0 dB

Initial Volume

Specify the initial volume level in Zone2 or Zone3 when this unit is turned on.

Adjustable range	Off, Mute, -80.0 dB to +16.5 dB
Default setting	Off
Adjustment increments	0.5 dB

Mono

Switches between stereo and monaural modes for Zone2 or Zone3 audio signal.

Off (Default)	Does not convert Zone2 or Zone3 audio signal to monaural sound.
On	Converts Zone2 or Zone3 audio signal to monaural sound.

Selecting the zone for optical output signal

Digital Out Assign

Selects main zone or Zone4 to which the optical audio signals are output from AV OUT/ZONE4 jacks.



Main	Outputs the optical signals to the main zone.
Zone4	Outputs the optical signals to Zone4.



■ Displaying the video on the TV monitor in Zone2, Zone3 or Zone4

Monitor Out Assign

Sets the component video, S-video or video (HDMI OUT/ZONE OUT) jacks for the main zone, Zone2, Zone3 or Zone4 use. When using one of HDMI OUT jacks to connect to the TV monitor in the main zone, jacks of MON.OUT can be used for another monitor for Zone2, Zone3 or Zone4.

Main (Default)	Outputs the video signals of the main zone operation status.
Zone2  1	Outputs the video signals for Zone2.
Zone3  1	Outputs the video signals for Zone3.
Zone4	Outputs the video signals for Zone4.

■ Setting the party mode

Party Mode Set

In party mode, the main zone sources can be played in Zone2, Zone3 and Zone4 simultaneously ([p. 155](#)). The party mode function can be enabled or disabled individually for Zone2, Zone3 and Zone4.

Target : Zone2

Disable	Disables the party mode function in Zone2.
Enable (Default)	Enables the party mode function in Zone2.

Target : Zone3

Disable	Disables the party mode function in Zone3.
Enable (Default)	Enables the party mode function in Zone3.

Target : Zone4

Disable	Disables the party mode function in Zone4.
Enable (Default)	Enables the party mode function in Zone4.

 1 : The Option menu and content window can be displayed on the monitor for Zone2 and Zone3. For details on features of Zone OSD, refer to “Features of the Zone2/Zone3 OSD” ([p. 153](#)).



Changing Zone2, Zone3 and Zone4 SCENE names

Zone Scene Rename

Editing the name of the selected scene in Zone2, Zone3 or Zone4.

- 1 Use **[9]Cursor Δ / ▽** repeatedly to select “Zone Scene Rename” and press **[9]ENTER**.
- 2 Press **[9]Cursor Δ / ▽** to select a zone and press **[9]ENTER**.
- 3 Press **[9]Cursor Δ / ▽** to select a scene you want to rename and press **[9]ENTER**.

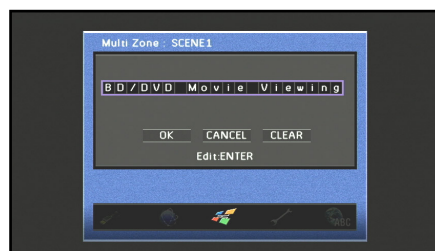

- 4 Press **[9]ENTER**.
Editing the name is available.
- 5 Press **[9]Cursor Δ / ▽** to select a character, and press **[9]Cursor </>** to enter the selected character.
- 6 Repeat step 5 to enter the desired scene name.
- 7 Confirm the zone name by pressing **[9]ENTER**.

- 8 Press **[9]Cursor ▽** to select “OK” and press **[9]ENTER** to register the new scene name.

- To cancel the operation without applying changes, select “CANCEL” and press **[9]ENTER**.
- To clear the characters entered in step 5, select “CLEAR” and press **[9]ENTER**.
- Scene names may consist of up to 20 characters.

Changing Zone names

Zone Rename

Editing the name of the selected zone.

- 1 Use **[9]Cursor Δ / ▽** repeatedly to select “Zone Rename” and press **[9]ENTER**.
- 2 Press **[9]Cursor Δ / ▽** to select a zone you want to rename and press **[9]ENTER**.



- 3 Press **[9]ENTER**.
Editing the name is available.
- 4 Press **[9]Cursor Δ / ▽** to select a character and press **[9]Cursor </>** to enter the selected character.
- 5 Repeat step 4 to enter the desired zone name.

- 6 Confirm the zone name by pressing **[9]ENTER**.
- 7 Press **[9]Cursor ▽** to select “OK” and press **[9]ENTER** to register the new zone name.

- To cancel the operation without applying changes, select “CANCEL” and press **[9]ENTER**.
- To clear the characters entered in step 4, select “CLEAR” and press **[9]ENTER**.
- Zone names may consist of up to 9 characters.

Making the receiver easier to use

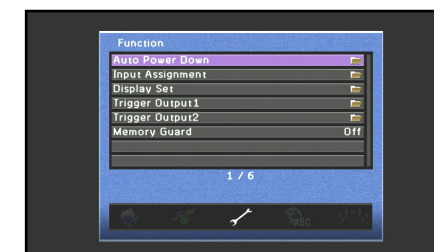

Function setup items

Auto Power Down	This unit enters standby mode if no operations are performed.
Input Assignment	Assigns the input jack to the selected input source.
Display Set	Specifies menu items displayed on TV screen and the front panel.
Trigger Output1	Specifies TRIGGER OUT 1 jack function.
Trigger Output2	Specifies TRIGGER OUT 2 jack function.
Memory Guard	Protects some settings against accidental modification.





Entering standby mode automatically when no operations are performed

Auto Power Down

If you do not operate this unit or use the remote control for an extended period of time, it will automatically go into standby mode (Auto Power Down function). This function's default setting is "Off." When you want to enable this function, set the amount of time to pass before this unit will enter standby.

4Hours	Goes into standby mode, when you have not operated this unit for four hours.
8Hours	Goes into standby mode, when you have not operated this unit for eight hours.
12Hours	Goes into standby mode, when you have not operated this unit for twelve hours.
Off (Default)	Auto Power Down function is disabled.

This unit starts a countdown of 30 seconds before entering the standby mode. Pressing any key of the remote control during the countdown cancels entering the standby mode and reset the timer.

Assigning component input and output jacks

Input Assignment

Assigns the coaxial or optical input jack(s) to the selected input source when this unit's initial settings do not correspond to your needs. Change the parameter to reassign the respective jacks and effectively connect more components.

Once the input jacks are reassigned, the corresponding component can be selected using the Input selector buttons.

Example: Assigning the OPTICAL input jack to "AV1."

1 Press **[ENTER]** to display the "Input Assignment" screen.

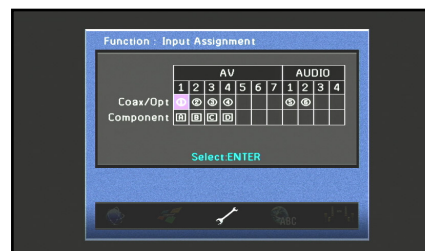

2 Press **[Cursor Δ/▽/◀/▶]** to select the cell at the intersection with the "AV1" and "Coax/Opt" and then press **[ENTER]**.

3 Press **[Cursor ◀/▶]** to select "3" and then press **[ENTER]**.

Select "None" to clear the existing assignment.

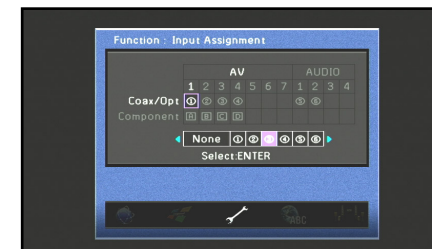

The choices indicate the following jacks.

①, ②, ⑥ : COAXIAL jacks

③, ④, ⑤ : OPTICAL jacks

[A], [B], [C], [D] : COMPONENT VIDEO jacks

The choices indicate the jacks marked the same alphanumeric on the rear of this unit. For details on marks on the rear of this unit, refer to "Rear panel" (p. 10).

4 Press **[RETURN]** to apply change and return to the previous screen.

- A specific item cannot be selected more than once for the same type of jack.
- Only component, coaxial and optical jacks can be reassigned.
- Coaxial and optical jacks cannot be assigned to the input at the same time.

■ Specifying menu display

Display Set

Specify front panel display brightness and TV screen wall paper.

Front Panel Display

Specify front panel display brightness and message scroll pattern.

Dimmer	Adjustable range: -4 - 0 Reduce brightness of the front panel display. As the value is lowered, the panel display darkens.
Scroll	Selects the manner in which display scrolls when the total number of characters exceeds the display area on the front panel display. Select "Continue" for continuous scrolling of all characters. Select "Once" to scroll through all characters once and then halt scrolling for display of only the first 14 characters.

Wall Paper

Specify the wall paper displayed on the TV screen when no video signal is input. Select one that you prefer.

Picture 1-3	Displays an image on the TV screen when there is no video signal.
Gray	Displays a gray background on the TV screen when there is no video signal.

■ Setting TRIGGER OUT functions

Trigger Output1

Trigger Output2

Synchronizes TRIGGER OUT 1 or 2 jack function with the power status of each zone or input switching.

Trigger Mode

Specify timing of electronic signal transmission to the TRIGGER OUT 1 or 2 jack.

Power (Default)	TRIGGER OUT 1 or 2 jack function is synchronized with the power status of the zone specified with "Target Zone."
Source	TRIGGER OUT 1 or 2 jack function is synchronized with input switching in the zone specified with "Target Zone." Electronic signal is transmitted according to the "Target Source" setting.
Manual	Select this to manually switch the output level for electronic signal transmission with "Manual."

Target Zone



Specify the zone with which TRIGGER OUT 1 or 2 jack function is synchronized.

Main	When "Trigger Mode" is set to "Power," electronic signal transmission is synchronized with the power status of the main zone. When "Trigger Mode" is set to "Source," electronic signal transmission is synchronized with input switching in the main zone.
Zone2	When "Trigger Mode" is set to "Power," electronic signal transmission is synchronized with the power status of Zone2. When "Trigger Mode" is set to "Source," electronic signal transmission is synchronized with input switching in Zone2.
Zone3	When "Trigger Mode" is set to "Power," electronic signal transmission is synchronized with the power status of Zone3. When "Trigger Mode" is set to "Source," electronic signal transmission is synchronized with input switching in Zone3.
Zone4	When "Trigger Mode" is set to "Power," electronic signal transmission is synchronized with the power status of Zone4. When "Trigger Mode" is set to "Source," electronic signal transmission is synchronized with input switching in Zone4.
All (Default)	When "Trigger Mode" is set to "Power," electronic signal transmission is synchronized with the power status of the main zone or Zone2, Zone3 or Zone4. When "Trigger Mode" is set to "Source," electronic signal transmission is synchronized with input switching in the main zone or Zone2, Zone3 or Zone4.



Target Source



Specify the output level of electronic signal transmitted each time input is switched.

Low 	Terminates electronic signal transmission when the input source specified with this option is selected.
High (Default) 	Electronic signal is transmitted when the input source specified with this option is selected.

This setting is available only when “Trigger Mode” is set to “Source.”

Manual

Manually switch the output level for electronic signal transmission. This setting can also be used to confirm proper function of the external component connected via the TRIGGER OUT 1 or 2 jack.

Low 	Stops the electronic signal transmission.
High (Default) 	Transmits the electronic signal.

This setting is available only when “Trigger Mode” is set to “Manual.”

Prohibiting setting changes

Memory Guard

Prohibits setting changes to prevent careless changes being made to the settings on Setup menu.

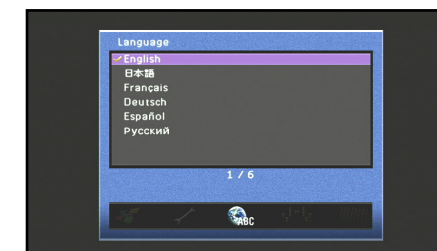

Off (Default)	Settings are not protected.
On	Prohibits changes to the settings on Setup menu until it is returned to “Off.” While set to “On,” the unit displays “Memory Guard!” when an attempt is made to change the settings.

Language



Select the language used for display of menus and messages. 
Choices: English (English), 日本語 (Japanese), Français (French), Deutsch (German), Español (Spanish), Русский (Russian)

For details on selecting a language, refer to “Language selection” ([p. 2](#)).

-  1: This unit outputs 0 V when selecting “Low.”
-  2: This unit outputs 12 V when selecting “High.”
-  3: Content window information is displayed in the language in which that information was released.

Confirming information of this unit (Information menu)

A variety of information for this unit can be displayed.

Selecting information

1 Press **[8] ON SCREEN**.

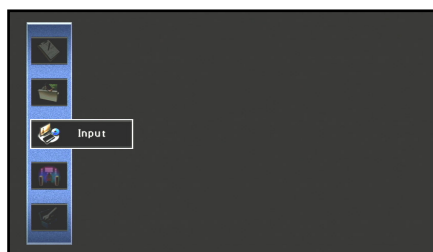

2 Use **[9] Cursor** Δ / ∇ to select "Information" and press **[9] ENTER**.

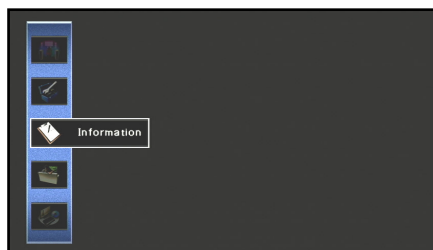

3 Use **[9] Cursor** \langle / \rangle to select an Information menu and press **[9] ENTER**.



Audio Signal information

Displays information on the current audio signal.

Format	Signal format. When this unit is unable to detect a digital signal, it automatically switches to analog input.
Sampling	The number of samples taken per second from a continuous signal to make a discrete signal.
Channel	The number of source channels in the input signal (front/surround/LFE). For example, a multi-channel soundtrack with 3 front channels, 2 surround channels and LFE is displayed as "3/2/0.1".
Bitrate	The number of bits passing a given point per second.
Dialogue	The dialogue normalization level preset to the current input bitstream signal.

- "—" is displayed when this unit cannot display the corresponding information.
- Some high-definition audio bitstream contents may not include the discrete surround back left and right channel signals, but are encoded at a sampling rate of 192 kHz.
- Even when direct bitstream output settings are applied, some players convert the Dolby TrueHD or Dolby Digital Plus bitstreams to the Dolby Digital bitstreams, while converting DTS-HD Master Audio or DTS-HD High Resolution Audio bitstreams to DTS bitstreams.

Video Signal information

Displays information on the current video signal.

HDMI Signal	Source video signal type and video signal output to this unit's HDMI OUT 1-2 jacks.
HDMI Resolution	Input signal (analog or HDMI) and output signal (HDMI) resolution.
Analog Resolution	Resolution of the source video signal and the analog video signal output to this unit's MONITOR OUT jacks.
HDMI Error	Error message for HDMI sources or connected HDMI devices (see p. 156). This information is displayed only when the error come up.

HDMI Monitor information

Displays information on the TV screen connected to this unit's HDMI OUT 1-2 jacks.

Interface	Displays information on the current connection interface.
Video Resolution	Displays the frequency for each video resolution of the TV currently connected.



Network information

Displays information on the network status. Refer to “Adjusting this unit’s network parameters” ([p. 125](#)) for details on setting the network status.

IP Address / Subnet Mask / Default Gateway	Displays the status of the current IP address assigned to this unit.
DNS Server (P) / DNS Server (S)	Displays the IP address of the primary and secondary DNS (Domain Name System) servers.
MAC Address	Displays the MAC address filter set to this unit.
Status	Displays the network status of this unit.

System information

Displays information on the current settings of the advanced setup.

Remote ID	Displays the Remote ID set to this unit.
TV Format	Displays the TV format set to this unit.
Speaker Impedance	Displays the speaker impedance set to this unit.
System ID	Displays the system ID of this unit.
Firmware Version	Displays the current version of the firmware installed to this unit.

When detecting the latest firmware over a network:

- exclamation point appears on the Information menu icon
- message indicating that the latest firmware is released appears in the System information

In this case, update the latest firmware by using “NETWORK” of “FIRM UPDATE” in Advanced Setup menu.

Zone information

Displays information on the currently selected input and the volume of Zone2, Zone3 or Zone4.

Controlling the remote control to operate various functions

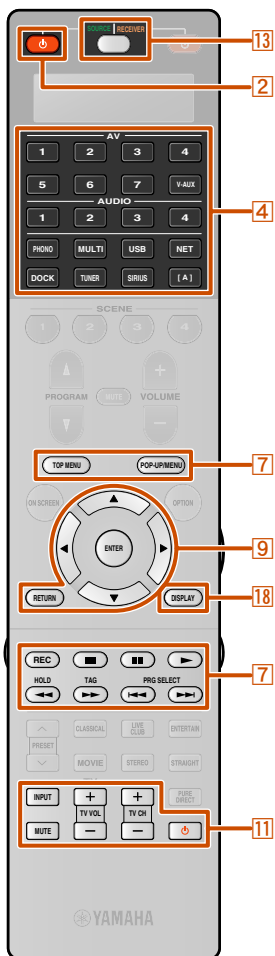

You can operate an external component such as TV and DVD player with the remote control of this unit by setting the code for external component (remote control code). The remote control code can be set for each input source. Individual setting allows you to switch external components seamlessly depending on the selected input source.

Selecting input source connected to DVD player

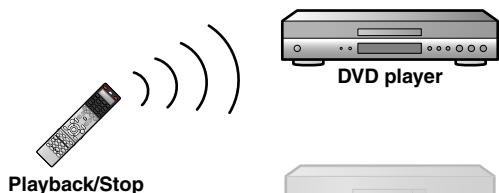

Selecting input source connected to CD player

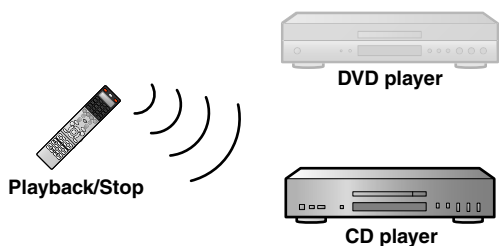

13 SOURCE/RECEIVER glows orange when operation of this unit is enabled.
13 SOURCE/RECEIVER glows green when operation of an external component is enabled.

Keys connecting external components

The remote control keys for controlling external components are available only when the external components have corresponding control keys.

2 SOURCE

Switches an external component on and off.

7 External component operation keys

Functions as a recording or playback key of an external component, or a menu display key.

9 Cursor, 9 ENTER, 9 RETURN

Operates the menus of external components.

11 TV control keys

11 INPUT	Switches video inputs of TV.
11 MUTE	Mutes TV volume temporarily.
11 TV VOL +/-	Controls the volume of TV.
11 TV CH +/-	Switches TV channels.
11 	Turns on and off TV.

18 DISPLAY

Switches an external component display.

23 Numeric keys

Functions as numeric keys of an external component.

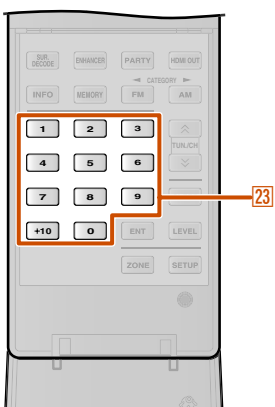

- 1 : When remote control codes for external components are registered with **4 Input selector** or **11** (**11 TV control keys**), the following operations are possible.
- When a TV remote control code is registered with **4 Input selector**, **7 TOP MENU**, **7 POP-UP MENU**, **9 Cursor**, **18 DISPLAY**, **23 Numeric keys** and **11 TV**

- control keys** can be used to control the TV selected with **4 Input selector**.
- When a remote control code for a device other than a TV is registered with **4 Input selector**, keys including the **9 Cursor**, **7 TOP MENU**, **7 POP-UP MENU**, **18 DISPLAY** and **23 Numeric keys** can be used to control

- external components, and the **11 TV control keys** can be used to control the TV registered with **11** .
- When a TV remote control code is registered with **11** , only **11 TV control keys** can be used to control the TV.



Customizing the remote control

Use the setup mode of the remote control to customize the remote control.

1 Open the cover of remote control and press **[29] SETUP**.

“SETUP” appears in the display window on the remote control.

2 Press **[9] Cursor Δ / ▽** repeatedly to select the desired setup mode.

Pressing **[13] SOURCE/RECEIVER** repeatedly can also change the setup mode.

Setup mode	Descriptions	Page
SETUP	Top setup mode menu.	—
LEARN	Learning mode. Use this feature to program codes from other remote controls.	137
PRESET	Preset mode. Use this feature to change the remote control code of each control area.	136
RENAME	Renaming mode. Use this feature to change the name of each control area.	139
MACRO	Macro programming mode. Use this feature to set the macro program.	140
CLEAR	Clearing mode. Use this feature to clear the configurations of this unit.	141

Setup mode	Descriptions	Page
ERASE	Erase mode. Use this feature to erase the learned functions of each button.	142
EX-IR	Extended IR code mode. This feature is for the authorized custom installers only.	—

3 After the configurations, press **[29] SETUP** again to exit from the setup menu.

NOTE

If no operation is performed for 30 seconds, this unit automatically exits from the setup menu.

Setting remote control codes

Default remote control code settings

The following remote control codes are assigned to input sources at factory default settings. For a complete list of available remote control codes, refer to “[Remote Control Code Search](#)” in the CD-ROM.

Control area	Category	Manufacturer	Remote control code
AV1	Blu-ray player/recorder	Yamaha	2064
AV2	—	—	—
AV3	—	—	—
AV4	—	—	—

Control area	Category	Manufacturer	Remote control code
AV5	—	—	—
AV6	—	—	—
AV7	—	—	—
V-AUX	—	—	—
AUDIO1	—	—	—
AUDIO2	CD player	Yamaha	5095
AUDIO3	—	—	—
AUDIO4	—	—	—
PHONO	—	—	—
MULTI	—	—	—
USB	—	—	—
NET	—	—	—
DOCK	—	—	—
TUNER	—	—	—
SIRIUS	—	—	—
[A]  1	—	—	—

NOTES

- You may not be able to operate your Yamaha component even if a Yamaha remote control code is preset as listed above. In this case, try setting another Yamaha remote control code.
- If this unit’s remote control is unable to control other components with specification of the corresponding remote control code, it can be programmed using other remote controls ([p. 137](#)).

 1: Use [A] for external component operations only. Set these keys to remote control codes if you want to perform external component operations without linking to input source selection of this unit. For example, it may be convenient to assign remote control codes for devices such as TVs.

■ Registering remote control codes for external component operations

The following section describes how to register remote control code using an example of the registration of the remote control codes of a Yamaha BD player connected to AV2 jack.

- Perform each of the following steps within 30 seconds. Settings will be automatically stopped if more than 30 seconds passes since the last operation. To reset, repeat from step 2.
- Remote control code of an external component cannot be set from the name or model number of a unit. Use “Remote Control Code Search” in the CD-ROM to search the available remote control codes from the category or manufacturer of external components.
- If multiple remote control codes exist, first set the first code in the list, if it does not work then try the other codes.

1 Use “Remote Control Code Search” in the CD-ROM to search the available remote control codes from the category or manufacturer of external components.

“2064” can be used for a Yamaha BD player.

2 Press **[29]SETUP**.
“SETUP” appears in the display window on the remote control.



3 Press **[9]Cursor Δ / ▽** repeatedly to select “PRESET” and press **[9]ENTER**. **💡1**

The remote control enters the preset mode. “PRESET” and name of the currently selected control area appears in the display window alternately.



4 Press **[4]AV2** to switch the input source to AV2. **💡2**

Perform the following steps to register the selected input source here to the remote control code.



5 Press **[9]ENTER**.
The current code setting appears.



6 Enter a remote control code “2064” using **[23]Numeric keys**.

A remote control code can be entered using **[9]Cursor Δ / ▽ / ◀ / ▶**.



Continues to the next page

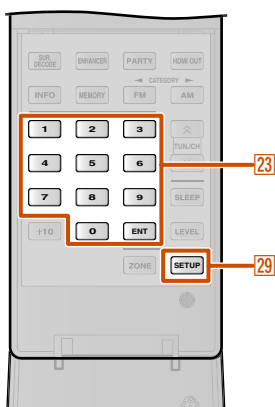
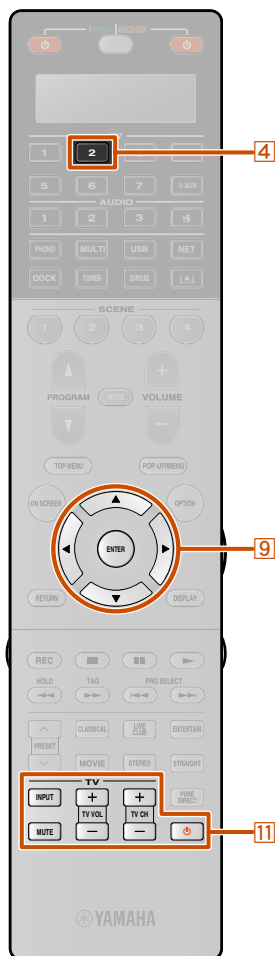

💡1 : **[23]ENT** can also be used for remote control settings as well as **[9]ENTER**.

💡2 : To control a TV with **[11]TV control keys** independently from the input source, press **[11]⏻** in step 4 and enter the remote control code for the TV. You can control that TV with **[11]TV control keys** regardless of the input source selection.

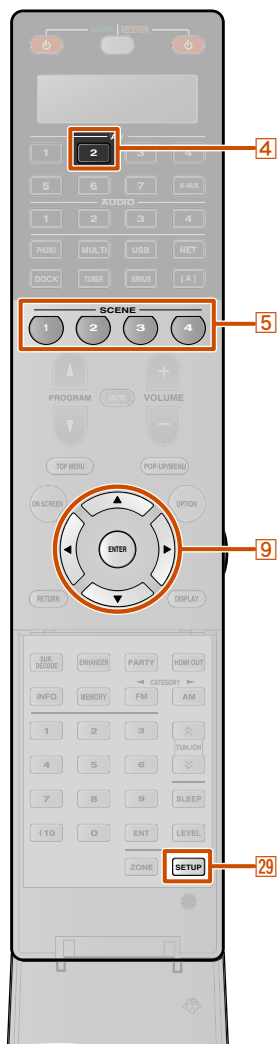

7 Press [9]ENTER to set the number.
 “OK” appears in the display window if setting was successful.
 “NG” appears in the display window if the setting was unsuccessful. In this case, start over from step 3.



If you continuously want to set up another code for another control area, repeat steps 4 to 7.

8 Press [29]SETUP again to exit from the setup menu.

If operation is not possible and the manufacturer of your component has more than one code, try each of them until you find the correct one.

NOTES

- “ERROR” appears in the display window on the remote control if you press a button not indicated in the respective step, or when you press more than one button simultaneously.
- The supplied remote control does not contain all possible codes for commercially available audio and video components (including Yamaha components). If operation is not possible with any of the remote control codes, program the new remote control function using the learning feature (p. 137) or use the remote control supplied with the component.
- Functions programmed using the learning mode take priority over remote control code functions.

Switching between BD player linked to scene selections

Press [5]SCENE and at the same time press [4]AV2 and hold it for approximately 3 seconds.
 “OK” appears in the display window if setting was successful.



Then you can operate the external components by switching the input source to AV2, or selecting AV2 in the registered scene.

Same steps for operating other external components, press [5]SCENE and at the same time press the input source key selected in step 3 and hold it for approximately 3 seconds.

Programming from other remote controls

The remote control of this unit can receive remote control signals from other remote controls and learn the remote control operation. If a key on the remote control does not work after being assigned with an external component’s function or if the remote control code for that function is not provided, use this learning feature to make the function operable with the remote control.

- Perform each of the following steps within 30 seconds. Settings will be automatically stopped if more than 30 seconds passes since the last operation. To reset, repeat from step 1.
- If the remote control of the external component uses infrared rays, this remote control can learn most of its functions. The remote control may not recognize special or consecutive signals.
- The keys may not operate the assigned functions depending on operating conditions of this unit.

1 Press [29]SETUP.
 “SETUP” appears in the display window.

2 Press [9]Cursor Δ / ▽ repeatedly to select “LEARN” and press [9]ENTER.

Continues to the next page



3 Select the operation mode (SOURCE, RECEIVER or TV mode) for which functions will be assigned to remote control keys.

- **SELECTING THE SOURCE MODE**
Press **[4] Input selector** to enter SOURCE mode. In this mode, remote control functions for the selected input source can be assigned to this unit's remote control.
- **RECEIVER MODE**
Press **[12] RECEIVER** to enter RECEIVER mode. In this mode, remote control functions for external amplifier can be assigned to this unit's remote control.

NOTE

When remote control functions are assigned for this mode, it may be impossible to operate this unit using the remote control.

- **TV MODE**
Press **[11] TV** to enter TV mode. In this mode, remote control functions for a TV can be assigned to this unit's remote control.

Remote control functions can be assigned to this unit's remote control keys as follows.

Mode	Keys
SOURCE	Keys for operating the external components such as [2] SOURCE , [7] External component operation keys or [9] Cursor $\Delta / \nabla / \triangleleft / \triangleright$.
RECEIVER	Keys for operating this unit such as [7] External component operation keys , [9] Cursor $\Delta / \nabla / \triangleleft / \triangleright$ and [23] Numeric keys .
TV 	[11] TV control keys

 **1** : Once **[11] TV control keys** are set in TV mode, the TV can always be controlled.
When **[11] TV control keys** are set in SOURCE mode, the TV specified in SOURCE mode can be controlled when the input source is selected.

4 Place this remote control about 2 to 4 in (5 to 10 cm) apart from the remote control of the external component on a flat surface so that their infrared transmitters are aimed at each other and then press **[9] ENTER**.

“PRES KEY” appears in the display window.

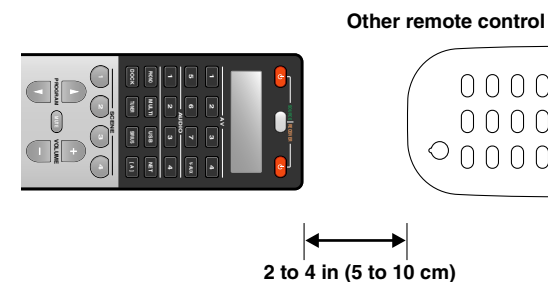

5 Press a key to which you want to assign the function.

“START” appears in the display window.



6 Press and hold the key you want to program on the other remote control until “OK” appears in the display window.

“NG” appears in the display window if learning was unsuccessful. In this case, start over from step 3.

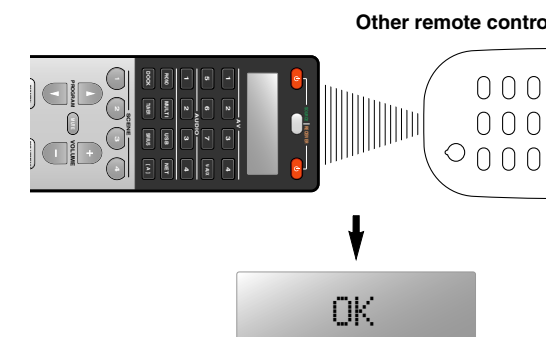

When you want to program another function, repeat steps 3 to 6.

Continues to the next page

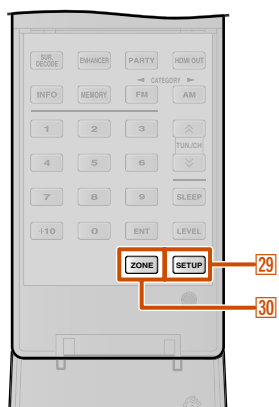
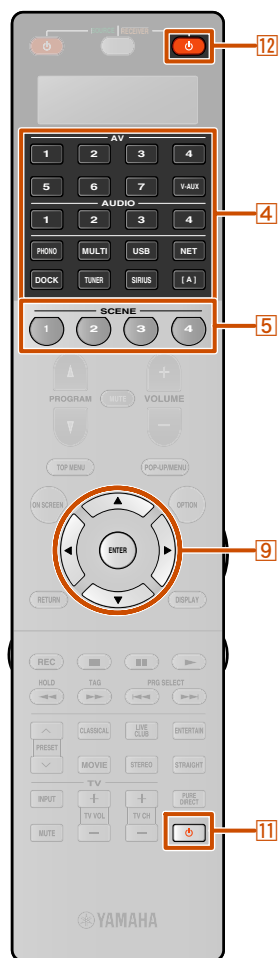

7 Press **[29]SETUP** again to exit from the setup menu.

NOTES

- “ERROR” appears in the display window on the remote control if you press a button not indicated in the respective step, or when you press more than one button simultaneously.
- This remote control can learn approximately 200 functions. However, depending on the signals learned, “FULL” may appear in the display before you program 200 functions. In this case, clear unnecessary programmed functions to make room for further learning ([p. 142](#)).
- Learning may not be possible in the following cases:
 - when the batteries in the remote control for this unit or other components are weak.
 - when the remote control is exposed to direct sunlight.
 - when the function to be programmed is continuous or uncommon.

Changing source names in the display window

The name of the control area (input source) that appears in the display window on the remote control can be changed.

- 1** Press **[29]SETUP**.
“SETUP” appears in the display window.
- 2** Press **[9]Cursor Δ / ▽** repeatedly to select “RENAME” and press **[9]ENTER**.
- 3** Press **[4]Input selector** or **[5]SCENE** to select the desired control area.
- 4** Edit the name of the control area.
To locate the position to edit, press **[9]Cursor < / >**.
To select a character, press **[9]Cursor Δ / ▽**.

Press **[9]Cursor Δ** to change the character in the following order, or press **[9]Cursor ▽** to go in the reverse order: A to Z, a to z, 0 to 9, space, symbols (-, +, /, :).

5 Press **[9]ENTER** to set the new name.
“OK” appears in the display window on the remote control if renaming was successful.

- When you want to rename the another control area, press **[4]Input selector** to select the desired control area and then press **[9]ENTER** and then carry out the operations of steps 4 to 5.
- Press **[12]RECEIVER** to rename the control area for the receiver.
- Press **[11]** to rename the control area for TV monitor.
- Press **[5]SCENE** key to rename the control area for the scenes. When rename the control area for the scenes of each zone, press **[30]ZONE** to select a zone before step 1.

6 Press **[29]SETUP** again to exit from the setup menu.

NOTE

“ERROR” appears in the display window on the remote control if you press a button not indicated in the respective step, or when you press more than one button simultaneously.



Macro programming features

The macro programming feature makes it possible to perform a series of operations with the press of a single button. For example, when you want to play a CD, normally you would turn on the components, select the CD input, and press the play button to start playback. The macro programming feature lets you perform all of these operations simply by pressing the macro button. The buttons listed as macro buttons below are factory set with macro programs. You can also program your own macros.

Pressing macro	To automatically transmit these signals	
	First	Second
RECEIVER		—
AV1-7	Turns on this unit	AV1-7
V-AUX		V-AUX
AUDIO1-4		AUDIO1-4
PHONO		PHONO
MULTI		MULTI
USB		USB
NET		NET
DOCK		DOCK
TUNER		TUNER
SIRIUS		SIRIUS
[A]		—

Recalling programmed macro operations

1 Press **29** **SETUP**.
“SETUP” appears in the display window.

2 Press **9** **Cursor** Δ / ∇ repeatedly to select “MACRO” and press **9** **ENTER**.



3 Press **9** **Cursor** Δ / ∇ repeatedly to select “ON” and press **9** **ENTER**.
Press a macro button (**12** **RECEIVER** or **4** **Input selector**) to perform the macro operation assigned to the button.

To exit the macro operation mode, press **9** **Cursor** Δ / ∇ to select “OFF” and press **9** **ENTER**.

NOTES

- While the remote control is running a macro program (the transmission indicator flashes), it does not accept any other operation.
- Continue to aim the remote control at the component the macro is operating until the macro operation is complete.

Programing macro operations

You can program your own macro to transmit several remote control commands in sequence at the press of a button. Be sure to set up remote control codes or perform learning operations before programming the macro.

NOTE

We do not recommend that you program continuous operations (for example, volume control) in a macro.

1 Press **29** **SETUP**.
“SETUP” appears in the display window.

2 Press **9** **Cursor** Δ / ∇ repeatedly to select “MACRO” and press **9** **ENTER**.

3 Press **9** **Cursor** Δ / ∇ repeatedly to select “EDIT” and press **9** **ENTER**.

4 Press the macro button (**12** **RECEIVER** or **4** **Input selector**) that you want to assign the macro operations to.

Continues to the next page

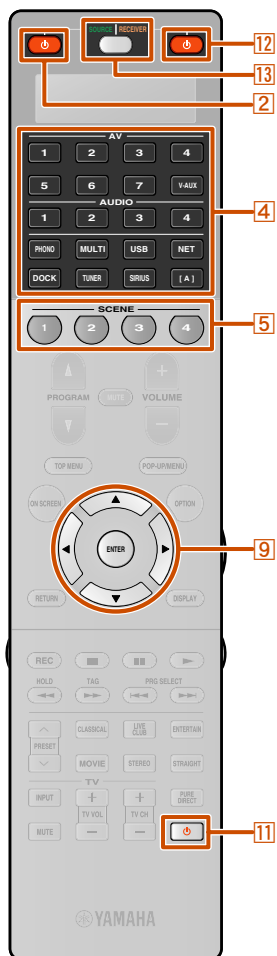

5 Press the buttons for the functions you want to include in the macro operation in sequence.

Press **13** **SOURCE/RECEIVER** to switch the controlled component.

Example

Set the input source to AV2 → Turn on the DVD player → Turn on the video monitor

Step 1 (“MACRO1”): Press **4** **AV2**.

Step 2 (“MACRO2”): Press **13** **SOURCE/RECEIVER** repeatedly to select the controlled component until MACRO2 and AV2 alternately appear in the display.

And then, press **2** **SOURCE**.

Step 3 (“MACRO3”): Press **11**.

6 Press **9** **ENTER** for 3 seconds or longer to confirm the program.

You can set up to 10 steps (10 functions). After you have set 10 steps, “FULL” appears.

7 Press **29** **SETUP** again to exit from the setup menu.

NOTE

“ERROR” appears in the display window if you press more than one button simultaneously.

Clearing configurations

Clear all changes made in each function set, such as learned functions, macros, renamed control area names and setup remote control ID.

Clearing function sets

1 Press **29** **SETUP**.

“SETUP” appears in the display window.

2 Press **9** **Cursor** Δ / ∇ repeatedly to select “CLEAR” and press **9** **ENTER**.

3 Press **9** **Cursor** Δ / ∇ repeatedly to select the operations that you want to and press **9** **ENTER**.

Operations assigned to the following modes can be cleared.

Operation modes

LEARN, PRESET, RENAME, MACRO, RESET

4 Press **4** **Input selector**, **12** **RECEIVER** ϕ or **11** ϕ to select the desired clear mode. 1

- “ALL” mode is set at first. When no mode is selected in this step, the settings of all modes are cleared.
- The other keys are used for the following operation modes.
 - “RENAME”: **5** **SCENE** key 2
 - “MACRO”: Macro button (**12** **RECEIVER** ϕ or **4** **Input selector**)

5 Press and hold **9** **ENTER** for about 3 seconds.

When the clearing is successful, “OK” appears in the display window.

NOTES

- “NG” appears in the display window if clearing was unsuccessful.
- “ERROR” appears in the display window if you press a button not indicated in the respective step, or if you press more than one button simultaneously.

6 Press **29** **SETUP** again to exit from the setup mode.

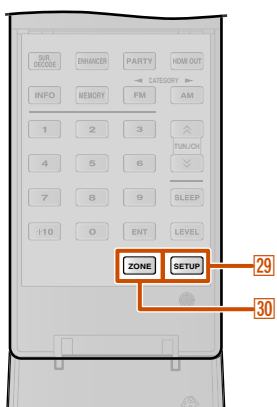

1: “RESET” initializes the settings of all modes. When selecting “RESET” in step 2, you cannot select the clear mode in step 4.

2: To clear the rename of each zone, press **30** **ZONE** to select the desired zone before step 1.

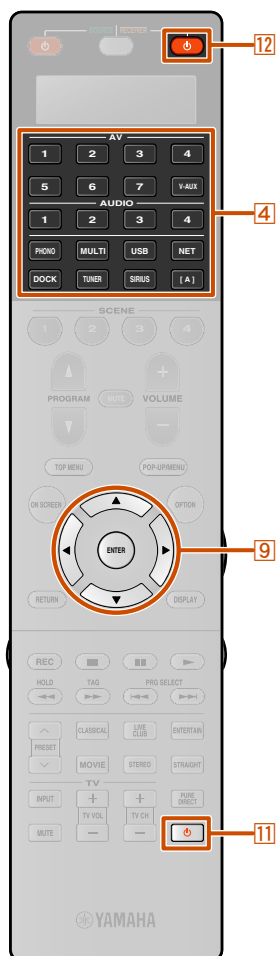

Clearing a function learned on each key

- 1 Press **29** **SETUP**.
“SETUP” appears in the display window.
- 2 Press **9** **Cursor** Δ / ∇ repeatedly to select “ERASE” and press **9** **ENTER**.
- 3 Press **4** **Input selector**, **12** **RECEIVER** \downarrow or **11** \downarrow to select the mode for which remote control key operation will be cleared.
- 4 Press **9** **ENTER**.
“PRES KEY” appears in the display window.
- 5 Press and hold the button you want to clear for about 3 seconds.
If clearing is successful, “OK” appears in the display window.
- 6 Press **29** **SETUP** again to exit from the setup menu.

- To continue resetting other keys, repeat step 3 to 5.
- Once you clear a learned function, the button reverts to the factory setting (or to the manufacturer setting if you have set remote control codes).

- NOTES**
- “NG” appears in the display window on the remote control if clearing was unsuccessful.
 - “ERROR” appears in the display window if you press more than one button simultaneously.

Simplified remote control

Use the supplied simplified remote control to make basic controls of this unit.

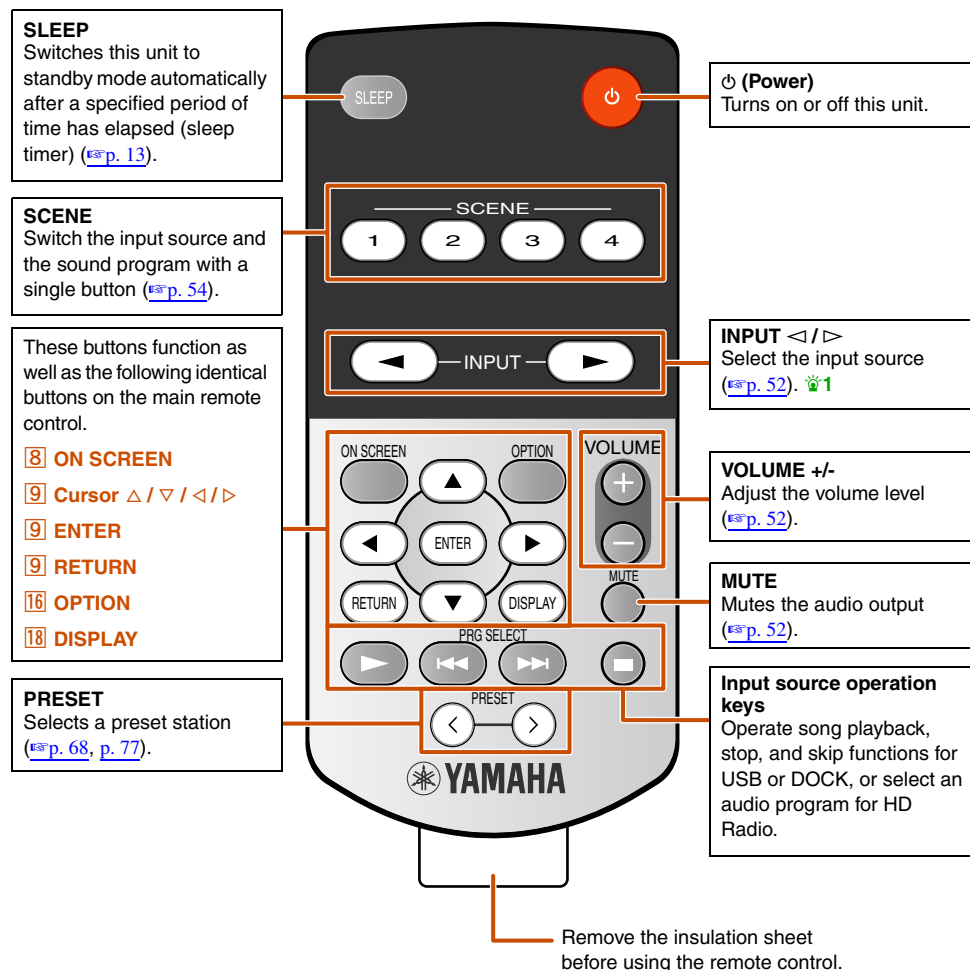

Setting the controlling zone of the simplified remote control

Use this feature to set the controlling zone (p. 154) and remote control ID (p. 145) of the simplified remote control.

Setting the remote control ID

- ID1: Press and hold \triangleleft (left cursor) and 1 for 3 seconds.
- ID2: Press and hold \triangleleft (left cursor) and 2 for 3 seconds.

Setting the controlling zone

- Main zone: Press and hold \triangleright (right cursor) and 1 for 3 seconds.
- Zone2: Press and hold \triangleright (right cursor) and 2 for 3 seconds.
- Zone3: Press and hold \triangleright (right cursor) and 3 for 3 seconds.

Replacing the battery in the simplified remote control

Change the battery when the operation range of the simplified remote control decreases.

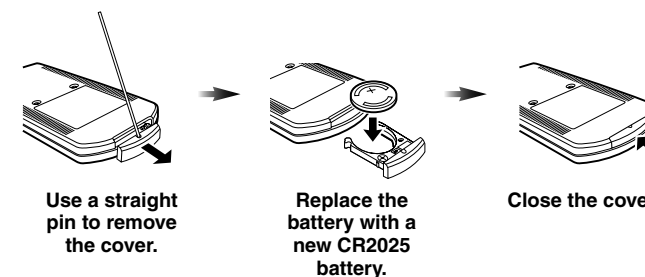

NOTES

- Insert the battery according to the polarity markings (+ and -).
- If the batteries run out, immediately remove them from the simplified remote control to prevent an explosion or acid leak.
- If a battery starts leaking, dispose of it immediately. Be careful not to let the leaking battery acid touch your skin or clothing.
- Before inserting new batteries, wipe the compartment clean.
- Dispose of batteries according to your regional regulations.

1: To select the detailed input for USB or NET (PC, NET RADIO, Rhapsody, or SIRIUS IR), use PRESET or SCENE function to select the desired one.

Extended functionality that can be configured as needed (Advanced Setup menu)

The Advanced Setup menu can be used for unit initialization and other useful extended functions. The Advanced Setup menu can be operated as follows.

Displaying/Setting the Advanced Setup menu

1 Switch this unit to the standby mode.

2 Press MAIN ZONE ϕ while pressing and holding STRAIGHT on the front panel.

Release STRAIGHT when “ADVANCED SETUP” is displayed on the front panel display.

After a few seconds, the top menu items are displayed.

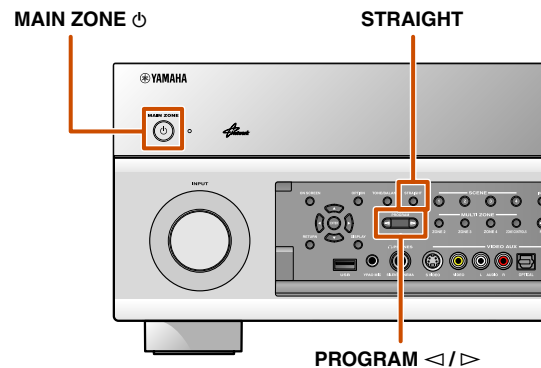

3 Press PROGRAM $\triangleleft/\triangleright$ repeatedly to select the item to be set from the following items.

In the Advanced Setup menu, you can set the following settings.

SPEAKER IMP.	Sets the impedance of speakers.
REMOTE SENSOR	Activate or deactivate the signal-receiving capability of the remote control sensor.
REMOTE CON AMP	Changes the remote control ID of a receiver.
SIRIUS PIN	Resets the parental lock code for the SIRIUS Satellite Radio tuner.
TV FORMAT	Specifies the TV's color encoding format.
MONITOR CHECK	Removes the up-scaling limitation on HDMI video output.
RECOV./BACKUP	Save and restore the settings of this unit.
INITIALIZE	Initializes various settings for this unit.
FIRM UPDATE	Update the firmware of this unit.
VERSION	Check the version of firmware currently installed on this unit.

4 Press STRAIGHT repeatedly to select the value you want to change.

5 Switch this unit to the standby mode, and then switch it on again.

The settings become effective and the unit is powered on.

Setting the impedance of speakers



Changes the unit settings depending on the impedance of the speakers connected. 💡1

6ΩMIN	Select the impedance when 6 Ω speakers are connected.
8ΩMIN (Default)	Select the impedance when speakers above 8 Ω are connected.

💡1 : For detailed procedures of speaker impedance settings, refer to “Changing speaker impedance” ([see p. 21](#)).

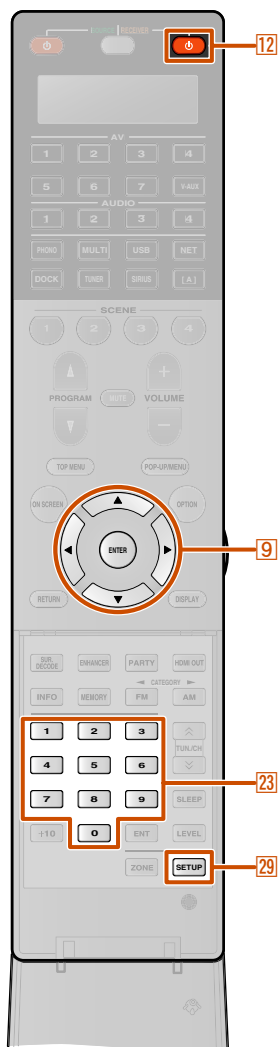

Remote sensor



Activate or deactivate the signal-receiving capability of the remote control sensor on the front panel of this unit.

ON (Default)	Activate the signal-receiving capability of the remote control sensor
OFF	Deactivate the signal-receiving capability of the remote control sensor

“ON” is recommended in most cases.

Avoiding crossing remote control signals when using multiple Yamaha receivers



The remote control of the unit can only receive signals from a receiver which has an identical ID (remote control ID). When using multiple Yamaha AV receivers, you can set each remote control with a unique remote control ID for its corresponding receiver.

On the contrary, if you are setting the same remote control ID for all receivers, you can use one remote control to operate 2 receivers.

ID1 (Default)	Receives the remote control signals set in ID1.
ID2	Receives the remote control signals set in ID2.

ID1 is set for both remote control and receiver by default. To avoid crossing remote control, change the remote control ID for both remote control and receiver.

To change the remote control ID

Perform each of the following steps within 30 seconds. Settings will be automatically stopped if more than 30 seconds passes since the last operation. To reset, repeat from step 1.

- Press **29** **SETUP**.
- Press **9** **Cursor** Δ / ∇ repeatedly to select “PRESET” and press **9** **ENTER**.
- Press **12** **RECEIVER** \downarrow and press **9** **ENTER**.
- Enter the desired remote control ID code.
To switch to ID1:
Enter “5019” using **23** **Numeric keys** or **9** **Cursor** Δ / ∇ / \triangleleft / \triangleright .
To switch to ID2:
Enter “5020” using **23** **Numeric keys** or **9** **Cursor** Δ / ∇ / \triangleleft / \triangleright .
- Press **9** **ENTER** to set the number.
“OK” appears in the display window if setting was successful.
“NG” appears in the display window if the setting was unsuccessful. In this case, start over from step 4.
- Press **29** **SETUP** again to exit from the setup menu.

Returns to ID1 after the remote control code is initialized (see p. 141).

Resetting the SIRIUS Satellite Radio™ parental lock code



Reset the SIRIUS Satellite Radio parental lock code to the factory default setting. If you forget the code, it can be reset.

RESET	Resets the code to the factory default setting.
CANCEL (Default)	Cancels resetting of the parental lock code.

Changing TV format



Change the color encoding format of OSD to PAL or NTSC (default), to match the format used by the TV connected via the HDMI OUT 1-2 or VIDEO (MONITOR OUT) jack.

Removing HDMI video output up-scaling limits



Removes the up-scaling limitation on video resolution when this unit and a TV are connected via HDMI jacks.

If a resolution supported by the monitor cannot be detected when configuring the up-scaling settings, this setting will remove the output limitation.

YES (Default)	Video output signals of a resolution not supported by the TV will not be transmitted.
SKIP	This unit ignores the TV's support capability and transmits input video signals to the TV.

Recovery and backup of the system settings



Save and restore the settings of this unit.

- 1 Press **STRAIGHT** repeatedly to select "BACKUP" or "RECOVERY" and press **INFO** on the front panel.

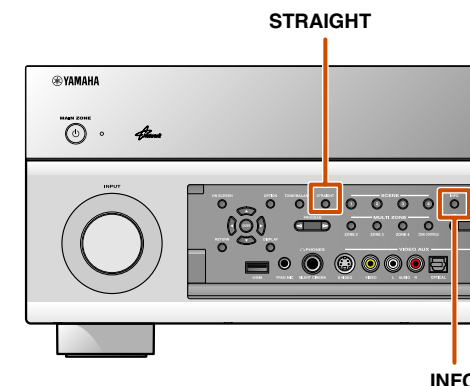

RECOVERY	Restores settings for this unit that have been saved.
BACKUP	Saves the current settings of this unit.

- 2 Press **INFO** to perform the "BACKUP" or "RECOVERY." 

- The settings except the system settings of this unit such as HD Radio tag or the account informations on Rhapsody and SIRIUS Internet Radio cannot be saved.
- "RECOVERY" cannot be selected if settings have not been previously saved.

 1: After performing "RECOVERY," turn off this unit.

Initializing various settings for this unit



Initializes various settings stored in this unit and sets it back to default.

Select the items to be initialized from the following.

DSP PARAM	Initializes all parameters for the sound programs.
VIDEO	Resets video conversion settings (resolution/aspect ratio) in the Setup menu.
NETWORK	Resets the settings of network such as IP address or the account of vTuner.
ALL	Resets this unit to default factory settings.
CANCEL (Default)	Does not initialize.

When an option other than CANCEL is selected, the applicable default settings will be restored when the unit switches to standby mode.

Firmware update



Update the firmware of this unit. For details on updating the firmware, refer to information supplied with updates.

When this unit detects the latest firmware over a network, the message indicating that the firmware is released is displayed in the System information ([p. 133](#)).

1 Press STRAIGHT repeatedly to select “USB” or “NETWORK.”

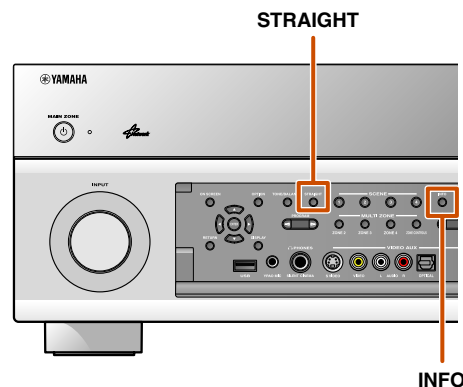

USB (Default)	Updates the firmware of this unit using a USB flash drive.
NETWORK	Updates the firmware of this unit over a network.

2 Press INFO to start update with the selected option.

- Do not use this feature unless the firmware must be updated.
- Be sure to read the information supplied with updates before updating firmware.

Firmware version



Check the version of firmware currently installed on this unit.

About the latest firmware

When installing the latest firmware, the new functions or fix of failure may be served.

- The latest firmware can be downloaded from our website.
- While displaying the ON SCREEN menu or “System” from Information menu, the information on the latest firmware is displayed via a network.

Using the HDMI Control function

This unit supports the HDMI Control function, which allows you to operate external components via HDMI. If devices that support HDMI Control (e.g., Panasonic VIERA Link-compatible TVs, DVD/Blu-ray Disc players, etc.) are connected 1, remote controls for those devices can be used to perform the following operations:

- Power synchronization (on/standby)
- Volume control, including Mute
- Changing the volume of the audio output signal device (either the TV or this unit)

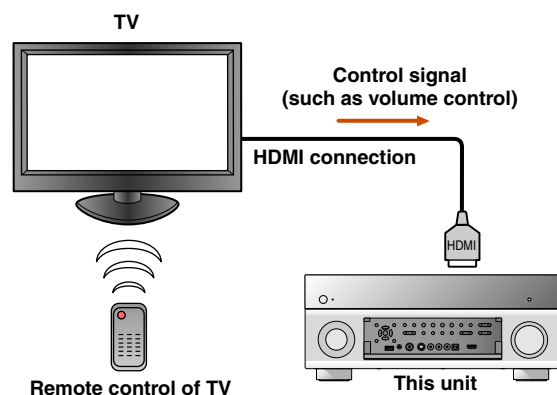

NOTE

The following is an example of how to connect this unit, a TV, and a DVD/BD player. Follow the instructions in your TV and DVD/BD player manuals, as well as the ones written below.

- Set the TV's HDMI Control function to "On"
- Follow the AV amplifier connection instructions, and connect this unit to the TV

1 Connect the TV that supports the HDMI Control function to this unit's HDMI output jack.

2 Connect the DVD/BD player that supports the HDMI Control function to this unit's HDMI input jack.

3 Turn on the TV and this unit.

Refer to the TV's instruction manual on how to operate external components.

4 Set the TV and this unit's HDMI Control function to "On."

This unit	Confirm that "HDMI Control" is set to "On" (p. 123) and select the HDMI OUT jack connected to the TV in "Control Select" (p. 123).  2
TV and DVD/BD player	Check the instruction manuals for those devices.

5 Turn the TV off.

Other synchronized HDMI Control devices are turned off with the TV. If they are not synchronized, unplug the power cable of the TV.

6 Turn the TV on.

Confirm that this unit has turned on in conjunction with the TV. If it is still off, turn it on manually.

7 Change the TV's input setting to the input jack that is connected to this unit (e.g., AV1).

8 If DVD/BD player that supports the HDMI Control function are connected to this unit, turn them on.

This unit	Confirm that the input source for the DVD/BD players has been selected. If a different input source has been selected, change it manually.
TV and DVD/BD player	Confirm that the video signal from the player is being properly received by the TV.

Operations 1-8 will not be required more than twice. However, perform operations 1-8 again when switching the HDMI OUT jack using Control Select.

9 Confirm that this unit is properly synchronized with the TV through the following operations by using the TV remote control.

- Power On/Off
- Volume Control
- Switching between audio output devices

If this unit is not synchronized to the TV's power operations, check that the HDMI Control function is set to "On" for both devices.

If they will not properly synchronize, unplugging and re-plugging the power cable of this unit and the TV may solve the problem.

 **1**: We recommend that you use TVs and DVD/BD players from the same manufacturer whenever possible.

 **2**: The default setting for the HDMI Control function is "Off."

Switching the input source on this unit automatically when listening to TV audio

When the HDMI Control (see p. 148) is operating properly, the input source of this unit is automatically changed to match operations carried out on the TV. When the TV is connected with HDMI OUT 1, the default input jack is AUDIO1. If the AUDIO1 optical digital jack is connected to the TV's audio output jack, then you can enjoy TV sound through this unit right away.

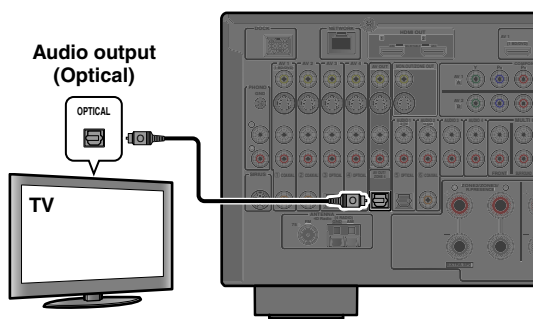
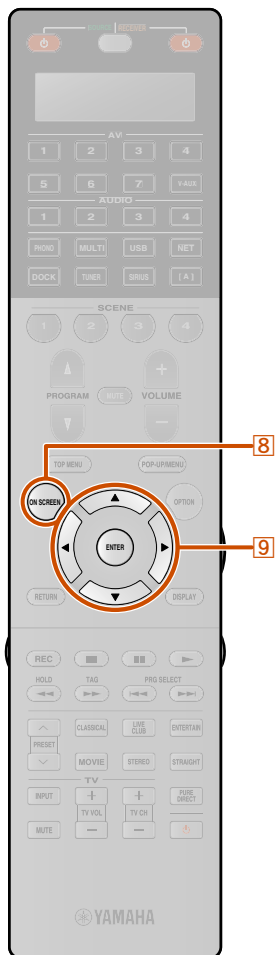

When the TV is connected with HDMI OUT 2, the default input jack is AUDIO3. If the AUDIO3 optical digital jack is connected to the TV's audio output jack, then you can enjoy TV sound through this unit right away.

To use other jacks to input audio signals from TV, carry out the following procedure.

1 Connect this unit and the TV with an HDMI cable.

2 Connect TV's audio output to this unit. The input jacks listed below are available to input TV's audio signals. Use the same jack type as used for the TV.

TV output jack	Input jack
Optical digital audio output	AUDIO1
Coaxial digital audio output	AUDIO2
Analog stereo output	AUDIO1, AUDIO2, AUDIO3, or AUDIO4

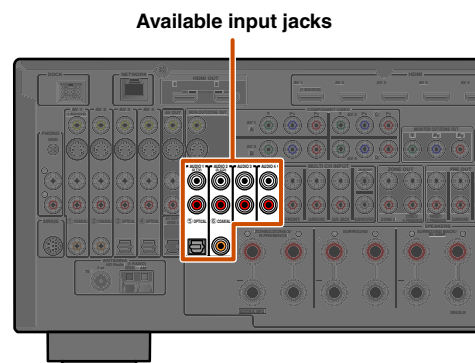

3 Press **[ON SCREEN]**. 1

4 Press **[Cursor Δ / ▽]** repeatedly to select "Setup" and press **[ENTER]**.

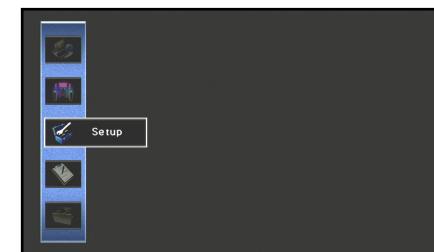

5 Press **[Cursor < / >]** repeatedly to select "HDMI" and press **[ENTER]**.



Continues to the next page

1: Refer to the "Setting various functions (Setup menu)" (see p. 114) for details on the Setup menu.

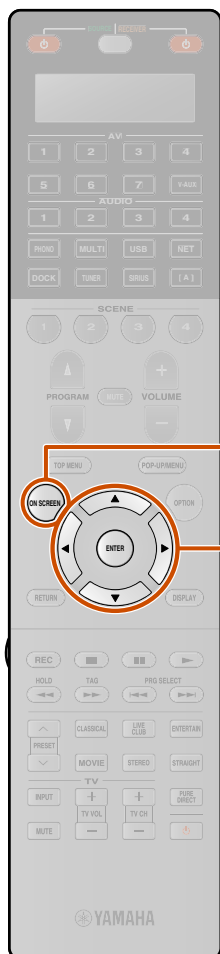

- 6** Make sure that “HDMI Control” is “On”
When “HDMI Control” is set to “Off,” press **9**ENTER and **9**Cursor Δ / ∇ to set to “On.”
- 7** Press **9**Cursor Δ / ∇ to select “Control Select” and press **9**ENTER.
- 8** Use **9**Cursor Δ / ∇ to select the HDMI OUT jack connected to the TV and press **9**ENTER.
- 9** Press **9**Cursor Δ / ∇ to select “TV Audio Input” and press **9**ENTER.
- 10** Use **9**Cursor Δ / ∇ to select the input jack connected in step 2.
- 11** Press **8**ON SCREEN when you have finished changing the settings.

If the TV hereafter transmits audio output signals, this unit will automatically switch to the input source chosen in step 10.

Single HDMI cable input to TV audio with Audio Return Channel function

When using a TV that supports HDMI functions and Audio Return Channel function, audio/video output from this unit to the TV or audio output from the TV to this unit can be transmitted through a single HDMI cable (Audio Return Channel function). Audio signals transmitted from the TV to this unit can be assigned to any input source.

- 1** Connect this unit and the TV with an HDMI cable.

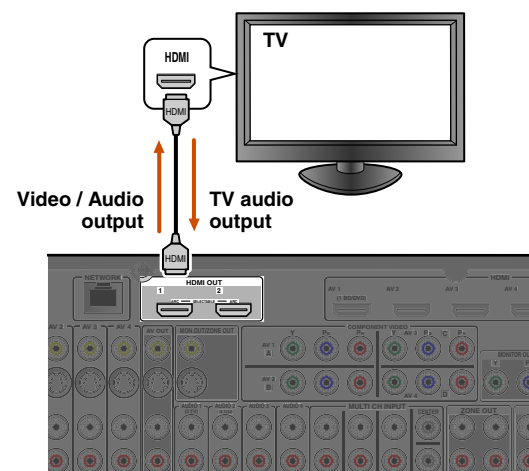

- 2** Press **8**ON SCREEN. 1
- 3** Press **9**Cursor Δ / ∇ repeatedly to select “Setup” and press **9**ENTER.

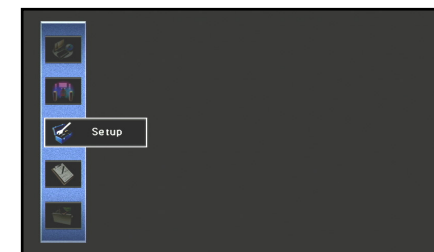



- 4** Press **9**Cursor \leftarrow / \rightarrow repeatedly to select “HDMI” and press **9**ENTER.

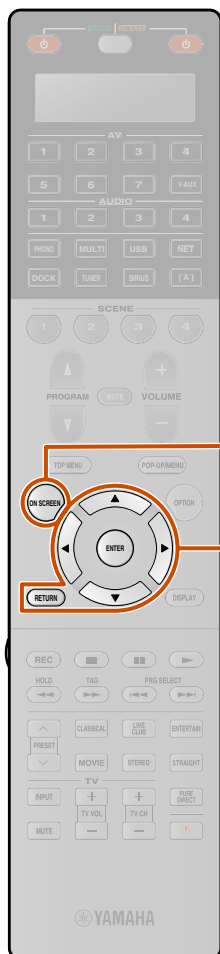

Continues to the next page

1: Refer to the “Setting various functions (Setup menu)” ([p. 114](#)) for details on the Setup menu.



- 5** Make sure that “HDMI Control” is “On.”
When “HDMI Control” is set to “Off,” press **[9]ENTER** and **[9]Cursor Δ / ▽** to set to “On.”
- 6** Press **[9]Cursor Δ / ▽** to select “Control Select” and press **[9]ENTER**.
- 7** Use **[9]Cursor Δ / ▽** to select the HDMI OUT jack connected to the TV and press **[9]ENTER**.
- 8** Press **[9]Cursor Δ / ▽** to select “TV Audio Input” and press **[9]ENTER**.
- 9** Use **[9]Cursor Δ / ▽** to select the input source to which the HDMI audio signals will be assigned, and press **[9]RETURN**.
- 10** Press **[9]Cursor Δ / ▽** to select “ARC (Audio Return Channel)” and press **[9]ENTER**. 
- 11** Press **[9]Cursor ▽** to select “On.”
The Audio Return Channel function will turn on.
- 12** Press **[8]ON SCREEN** to close the Setup menu.

If the TV hereafter transmits audio output signals, this unit will automatically switch to the input source chosen in step 9.

 **1** : While the Audio Return Channel function is on, the jack selected for the input source cannot be used.

Enjoying the contents in another room

This unit allows you to configure a multi-zone audio system. The multi-zone feature allows you to set this unit to reproduce separate input sources in the main zone and the second zone (Zone2), third zone (Zone3) and fourth zone (Zone4). You can control this unit from the second zone or third zone using the supplied remote control.

From the AV OUT/ZONE4 OUT jacks From the ZONE2 OUT/ZONE3 OUT jacks

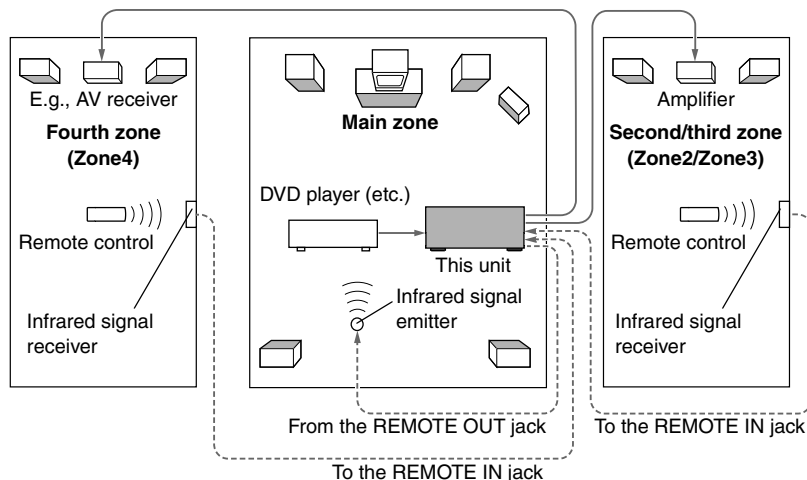

Only analog signal can be sent to Zone2 or Zone3. If you want to output sound from Zone2 or Zone3, connect an external component to AV1-4, AUDIO1-4 or V-AUX by analog connection. For example, if you want to output sound from an HDMI DVD player in Zone2, you must connect the component to this unit by both HDMI and analog connections. Optical digital audio signal can be sent to Zone4 when "Digital Out Assign" is set to "Zone4." Refer to "Selecting the zone for optical output signal" ([p. 126](#)) for details. If you want to output sound from Zone4, connect an external component to AV1-4, AUDIO1-4 or V-AUX by digital connection.

Connecting Zone2, Zone3 or Zone4

You need the following additional equipment to use the multi-zone functions of this unit:

- An infrared signal receiver in the second zone and/or third zone.
- An infrared signal emitter in the main zone. This emitter transmits infrared signals from the remote control to a CD player or a DVD player, etc. in the main zone via the infrared signal receiver in the second zone and/or third zone.
- An amplifier and speakers in the second zone and/or third zone.
- A TV in the second zone, third zone or fourth zone.

Since there are many possible ways to connect and use this unit in a multi-zone configuration, we recommend that you consult with your nearest authorized Yamaha dealer or service center about the multi-zone connections that best meet your requirements.

When using the external amplifier

An amplifier located in the second, third and fourth zones can be connected to this unit as shown below.

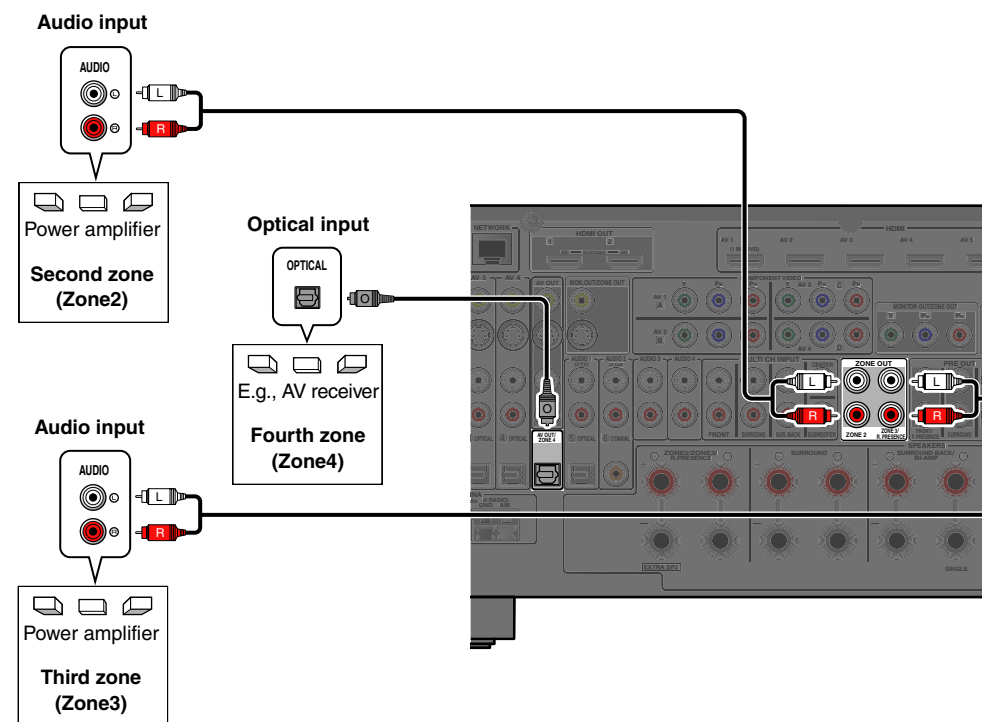

To avoid unexpected noise, DO NOT USE the multi-zone feature with CDs encoded in DTS.

When using the internal amplifier of this unit

Connect the speakers in the second zone and/or third zone to the EXTRA SP jacks directly ([p. 21](#)).

Connecting zone video monitors

Connect the video monitor(s) in Zone2, Zone3 or Zone4 to MONITOR OUT/ZONE OUT jacks. If you connect the multiple zone video monitors to these jacks, the video monitors play back the selected input source for the Zone2, Zone3 or Zone4.

To assign the MONITOR OUT/ZONE OUT jacks to Zone2, Zone3 or Zone4 configure “Monitor Out Assign” ([p. 127](#)).

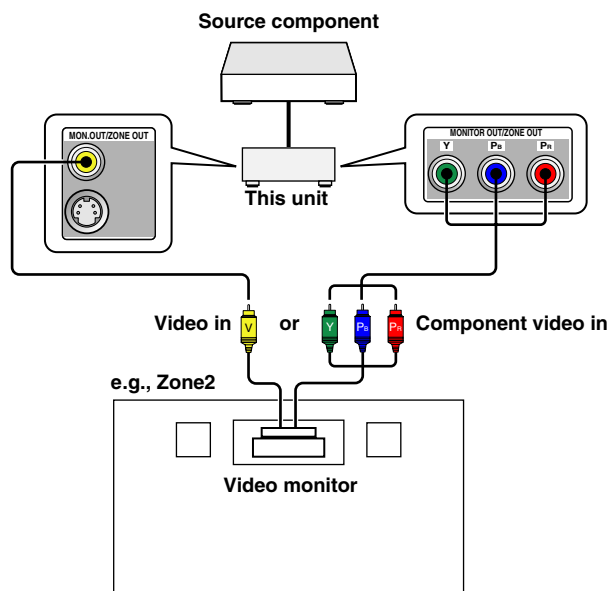

When “Monitor Out Assign” is set to “Zone2” or “Zone3,” the content window and Option menu of the input selected for the assigned zone can also be displayed on the TV monitor in the assigned zone.
(Only video signals input from the external component is output to the TV monitor in Zone4.)

Features of the Zone2/Zone3 OSD

When “Monitor Out Assign” is set to “Zone2” or “Zone3,” the Zone2 or Zone3 OSD is displayed on the TV monitor in Zone2 or Zone3.

The Zone2 or Zone3 OSD differ from the main OSD by available features. The available features for Zone2 or Zone3 OSD are as follows.

✓: available feature

		Features	Main OSD	Zone OSD
ON SCREEN menu	Input menu	Selecting Input	✓	—
		Configuring Input	✓	—
	Sound Program menu	Selecting Sound Program	✓	—
		Configuring Sound Program	✓	—
	Scene menu	Selecting Scene	✓	—
		Configuring Scene	✓	—
Setup menu			✓	—
Information menu			✓	—
Content window	Now Playing view		✓	✓
	Browse view		✓	✓
Option menu	Tone Control, Balance, Repeat 🌟1, Shuffle 🌟1		✓	✓
	Other functions		✓	—

Controlling this unit with the remote control in other rooms

This unit is equipped with two REMOTE IN and REMOTE OUT jacks. These jacks can be used to control this unit and other components from Zone2, Zone3 or Zone4 ([p. 39](#)).

Some Yamaha models can be directly connected to the REMOTE jacks of this unit. These models may not require an infrared signal emitter. Up to 6 Yamaha components can be connected as shown below.

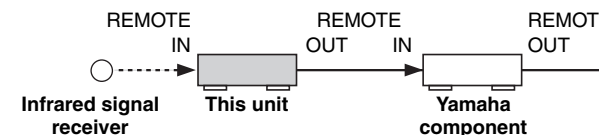

🌟 1: Only when selecting DOCK/PC/USB/Rhapsody, Repeat and Shuffle can be displayed.



Controlling Zone2, Zone3 or Zone4

The remote control can be used to select and control Zone2, Zone3 or Zone4 devices. The available operations are as follows:

- Selecting the input source of Zone2, Zone3 or Zone4.
- Tuning into FM or AM when “TUNER” is selected as the input source of Zone2, Zone3 or Zone4.
- Tuning into SIRIUS Satellite Radio when “SIRIUS” is selected as the input source of Zone2, Zone3 or Zone4.
- Adjust the volume of Zone2, Zone3 or Zone4 devices (when connected via the built-in amplifier).

Activating the Zone2, Zone3 or Zone4 operation mode

Press **30** ZONE to ZONE2, ZONE3 or ZONE4 before attempting to use the remote control to control Zone2, Zone3 or Zone4 devices.

Operating Zone2, Zone3 or Zone4

To enable and disable the audio output to Zone2, Zone3 or Zone4

Press **12** RECEIVER .

To select an input source for Zone2, Zone3 or Zone4

Press **4** Input selector.

Only the following sources are available for the Zone2 or Zone3

AV1-4 (only analog audio input), V-AUX (only analog audio input), AUDIO1-4 (only analog audio input), PHONO, USB, NET, DOCK, TUNER, SIRIUS

Only the following sources are available for the Zone4

AV1-4 (only COAXIAL/OPTICAL input), V-AUX (only OPTICAL input), AUDIO1-2 (only COAXIAL/OPTICAL input)

To use SCENE function for Zone2, Zone3 or Zone4

Press and hold **5** SCENE key for about 3 seconds to register the current setting to the scene.

Press **5** SCENE key to load the registered setting.

The following settings can be registered for each scene of the Zone2 or Zone3

Input, Master Volume, Tone Control

The following settings can be registered for each scene for Zone4

Input

To enable the sleep timer for Zone2, Zone3 or Zone4

Automatically switch the Zone2, Zone3 or Zone4 device to standby mode after a specified period of time has elapsed (sleep timer). Press **27** SLEEP repeatedly to specify a time for the sleep timer function.



Adjusting Zone2, Zone3 or Zone4 high-/low-frequency sound (Tone Control)

1 Press ZONE CONTROL on the front panel.

2 Press TONE/BALANCE on the front panel repeatedly to select “Treble” or “Bass.”

3 Press PROGRAM to adjust the output level in the applicable frequency range.

Adjustable range	-10.0 dB to +10.0 dB
Adjustment increments	2.0 dB

The display returns to the previous display soon after the key is released.



Adjusting Zone2, Zone3 or Zone4 front speaker balance

1 Press **ZONE CONTROL** on the front panel.

2 Press **TONE/BALANCE** on the front panel repeatedly to select “Balance.”

3 Press **PROGRAM** </> to adjust balance.
The display returns to the previous display soon after the key is released.

Controlling the content window on the TV monitor in another room

When “Monitor Out Assign” is set to “Zone2” or “Zone3,” the following items can be set with Option menu in the Zone2 or Zone3.

- Adjusting the Tone Control for the Zone2 or Zone3.
- Setting the Repeat and Shuffle functions. (only when selecting DOCK/PC/USB/Rhapsody)

NOTE

The Option menu in Zone2 or Zone3 can be controlled with the same operation as for controlling the Option menu for the main zone (p. 62).

Enjoying the music in all rooms

Use this feature to play main zone sources in other zones simultaneously. This feature is useful when you want to play back main sources as background music in a home party, etc. When using the party mode, set “Party Mode Set” to “Enable” (p. 127).

Press **24PARTY** to turn on or off the party mode.

“Party Mode On” or “Party Mode Off” appears on the front panel display or the TV screen.

While this unit is in the party mode, the PARTY indicators turn on in the front panel display.

- Input audio signals are mixed down to 2ch Stereo and output at the analog ZONE2 OUT or ZONE3 OUT jacks.
- Party mode can be turned on only when the power of main zone is turned on.
- Party mode automatically turns off when the power of main zone is turned off.



APPENDIX

Troubleshooting

Refer to the table below when this unit does not function properly.

If the problem you are experiencing is not listed below, or if the instructions below do not help, turn off this unit, disconnect the power cable, and contact the nearest authorized Yamaha dealer or service center.

General

Problem	Cause	Remedy	See page
The power will not turn on.	The protection circuitry operated 3 times consecutively.	As a safety precaution, when the protection circuitry operates 3 times consecutively, the capability to turn on the power is disabled. Contact your nearest Yamaha dealer or service center to request repair.	—
The unit enters standby mode soon after the power is turned on.	The power cable is not completely inserted.	Connect the power cable properly to an AC wall outlet.	—
	(When this unit is turned back on and “CHECK SP WIRES!” is displayed.) The protection circuitry has been activated because this unit was turned on while a speaker cable was shorted.	Make sure that all speaker cables between this unit and speakers are connected properly.	22
This unit cannot be turned off or does not work properly.	The internal microcomputer is hung-up due to an external electric shock (such as lightning or excessive static electricity) or by a drop in power supply voltage.	Disconnect the power cable from the AC wall outlet, wait about 30 seconds and then plug it in again.	—
	The batteries in the remote control may have lost their charge.	Replace all batteries.	13
The unit enters standby mode.	The protection circuitry has been activated because of a short circuit, etc.	Check that the speaker with an impedance of at least 6 Ω.	—
		Check that the speaker impedance settings are correct.	21
		Check that the speaker wires are not touching each other, then turn the unit back on.	—
	The sleep timer has turned off the unit.	Turn on the unit, and play the source again.	—

Problem	Cause	Remedy	See page
After display of a countdown on the front panel, the unit goes into standby mode.	If you do not use take any action, the Auto Power Down function operates.	Turn on the unit, and play the source again.	—
		In the Setup menu “Auto Power Down” (“Function” → “Auto Power Down”), increase the time until switching to standby mode, or turn off the Auto Power Down function.	129
No sound.	Incorrect input or output cable connections.	Connect the cables properly. If the problem persists, the cables may be defective.	33
	Speaker connections are not secure.	Secure the connections.	22
	The HDMI components connected to the unit do not support the HDCP copy protection standards.	Connect HDMI components that support the HDCP copy protection standards.	—
	The audio input into the device is set to playback through the TV.	In the Setup menu, set the “Amp” of “Audio Output” (“HDMI” → “Audio Output” → “Amp”) to “On.”	124
	No appropriate input source has been selected.	Select an appropriate input source with Input selector .	52
	The volume is turned down or muted.	Turn up the volume.	—
	Signals that this unit cannot reproduce are being input from a source component, such as a CD-ROM.	Use an input source that has signals that can be reproduced on this unit.	—



Problem	Cause	Remedy	See page
No picture.	The video signal output from this unit is not supported by a monitor connected to this unit via the HDMI OUT 1-2 jacks.	Displays the Advanced Setup menu and select "VIDEO" in "INITIALIZE" to reset the video parameters.	147
		Displays the Advanced Setup menu and set "MONITOR CHECK" to "YES."	146
	An appropriate video input is not selected on the TV.	Select an appropriate video input on the TV.	—
No sound is output from a specific speaker.	The speaker is malfunctioning. Check the Speaker indicators on the front panel display. If the corresponding indicator lights up, connect another speaker and check if sound is output.	If sound is not output, the unit may be malfunctioning.	11
	The playback component or speakers are not connected properly.	Connect the cables properly. If the problem persists, the cables may be defective.	22, 33
	Output from that speaker is disabled.	Check the Speaker indicators on the front panel display. If the corresponding indicator is turned off, try the following. 1) Change to a different input source. 2) With the selected sound program, sound is not output from that speaker. Select another sound program. 3) "None" may have been selected for that speaker on this unit. Display "Speaker" in the Setup menu, and set respective parameters to enable output from that speaker ("Speaker" → "Manual Setup" → "Configuration").	11, 116
	The volume of that speaker is set to the minimum in "Speaker" in the Setup menu.	Display "Speaker" in the Setup menu and adjust the volume ("Speaker" → "Manual Setup" → "Level").	118
	(If hardly any sound comes from one channel) Speaker output balance is not set correctly.	Balance the volume of each speaker from "Level" in the Setup menu ("Speaker" → "Manual Setup" → "Level").	118
	Sound may not be output from certain channels, depending on the input source or sound program.	Try another sound program.	55

Problem	Cause	Remedy	See page
Only the center speaker outputs substantial sound.	When a monaural source sound program is applied, for some surround decoders, sound from all channels is output from the center speaker.	Try another sound program.	55
No sound is heard from the presence speakers.	This unit is in straight decoding mode and the audio input signals have no surround channel.	Press STRAIGHT to exit straight decoding mode.	56
	Sound may not be output from certain channels depending on input sources or sound programs.	Try another sound program.	55
No sound is heard from the surround speakers.	Sound may not be output from certain channels depending on input sources or sound programs.	Try another sound program.	55
No sound is heard from the surround back speakers.	"Extended Surround" in the Option menu is set to "Off," or an input signal does not contain a surround back flag with "Extended Surround" set to "Auto."	Set "Extended Surround" other than "Off" or "Auto."	64
No sound is heard from the subwoofer.	A subwoofer is not connected, or it is inactive.	Check that a subwoofer is connected correctly, and from the Setup menu "Subwoofer1" or "Subwoofer2" ("Speaker" → "Manual Setup" → "Configuration" → "Subwoofer1" or "Subwoofer2"), set the subwoofer to "Use."	23, 117
	The subwoofer is turned off.	Turn the subwoofer power on. If the subwoofer includes an Auto Power Off function, then lower the Auto Power Off sensitivity settings.	—
	The source does not contain LFE (see p. 166) or low frequency signals.		—
The audio input sources cannot be played in the desired digital audio signal format.	The connected component is not set to output the desired digital audio signals.	Set the playback component properly referring to its instruction manual.	—



Problem	Cause	Remedy	See page
There is noise interference from digital or radio frequency equipment.	This unit is too close to other digital or radio frequency equipment.	Move this unit further away from such equipment.	—
Noise/hum noise is heard.	Incorrect cable connection. Connect the audio cables properly.	If the problem persists, the cables may be defective.	—
	A DTS-CD is being played back.	1) When only noise is output If a DTS bitstream signal is not properly input to this unit, only noise is output. Connect the playback component to this unit by digital connection and playback the DTS-CD. If the condition is not improved, the problem may result from the playback component. Consult the manufacturer of the playback component. 2) When noise is output during playback or skip operation Before playing back the DTS-CD, display the Input menu after selecting the input source and set “Decoder Mode” to “DTS.”	—
The volume cannot be increased, or the sound is distorted.	The component connected to the output jacks of this unit is not turned on.	When the component connected to the output jacks of this unit is not turned on, the sound may be distorted, or the volume may be decreased due to the nature of AV receivers. Turn on all components connected to this unit.	—
	“Max Volume” is set to a low value.	Set it to a higher value.	120

HDMI™

Problem	Cause	Remedy	See page
The front panel display HDMI indicator is flashing.	An error with the HDMI connection has occurred.	Try re-inserting the HDMI cable.	—
		Confirm that HDMI video that is not supported by the unit is not being input (Information menu → “Video Signal”).	132
No picture or sound.	The number of components is over the limit.	Disconnect some of the HDMI components.	—
	The connected HDMI component does not support high-bandwidth digital copyright protection (HDCP).	Connect an HDMI component that supports HDCP.	—
(When using HDMI Control function) TV sound is not output from this unit when operating the remote control of the TV.	The TV audio output is not connected to this unit, or the setting to match operations carried out on TV is not set.	Connect the TV audio output to this unit, and then select the connected input source in “TV Audio Input” (Setup menu → HDMI → TV Audio Input).	124
	(When using Audio Return Channel function) The Audio Return Channel function is not working.	Make sure that your TV supports Audio Return Channel. Set the Audio Return Channel function to on (Setup menu → HDMI → ARC (Audio Return Channel)).	123



Tuner (FM/AM)

FM

Problem	Cause	Remedy	See page
FM stereo reception is noisy.	You are too far from the station transmitter, or the input from the antenna is weak.	Check the antenna connections.	42
		Switch to monaural mode.	69
		Replace the outdoor antenna with a more sensitive multi-element antenna.	—
There is distortion, and clear reception cannot be obtained even with a good FM antenna.	There is multi-path interference.	Adjust the antenna height or orientation, or place it in a different location.	—
The desired station cannot be tuned into with the automatic tuning method.	You are in an area far from a station, or input from the antenna is weak.	Replace the outdoor antenna with a more sensitive multi element antenna.	—
		Use TUN./CH to manually select the station.	67
“No Presets” is displayed.	No preset stations are registered.	Register stations you want to listen to as preset stations before operation.	67
“Wrong Station” is displayed.	An invalid FM/AM frequency has been input.	Input a frequency that can be received.	—

AM

Problem	Cause	Remedy	See page
The desired station cannot be tuned into with the automatic tuning method.	The signal is weak, or the antenna connections are loose.	Adjust the AM loop antenna orientation.	—
		Use the manual tuning method.	67
Automatic station preset does not work.	Automatic station preset is not available for AM stations.	Use manual station preset.	67

Problem	Cause	Remedy	See page
Continuous crackling and hissing noises are heard.	The supplied AM loop antenna is not connected.	Connect the AM loop antenna correctly even if you use an outdoor antenna.	42
	The noises may be caused by lightning, fluorescent lamps, motors, thermostats, or other electrical equipment.	It is difficult to completely eliminate noise, but it can be reduced by installing and properly grounding an outdoor AM antenna.	—
Buzzing and whining noises are heard.	A TV set is being used nearby.	Move this unit away from the TV set.	—

HD Radio™ Reception

Problem	Cause	Remedy	See page
This unit cannot receive the HD Radio signals of the selected radio station.	The radio station provides analog FM/AM radio service only.	Select other radio stations that provides the HD Radio service.	70
	The signal is too weak.	Adjust the antenna position.	—
		Use a high-quality FM/AM antenna.	—
“Audio Mode” in the Option menu is set to “Mono.”	Set “Audio Mode” to “Auto.”	73	
This unit cannot select other audio programs than the main program.	The radio station provides one audio program only.		—
HD Radio information does not appear.	The radio station does not provide the information.		—
There is no sound immediately after a station is received.	After an HD Radio station is received, about 5 seconds passes before sound can be heard.		—
HD Radio information is not displayed properly.	The hold function is enabled.	Press HOLD to disable the hold function.	72



iTunes Tagging

Problem	Cause	Remedy	See page
Tag data cannot be transferred to your iPod when it is station in the Universal Dock for iPod (YDS-10).	“YDS-10” does not support tag file transfer.	Use “YDS-12” or “YDS-11” to transfer tag data from this unit to your iPod.	—

Status message	Cause	Remedy	See page
Insufficient Data	Tag data is not saved because of invalid data.	The selected HD Radio program (or song being played) does not support the iTunes Tagging feature.	—
Tag Already Stored	Tag data for the same content has been already saved.		—
Tag Storage full	Tag data cannot be stored because the internal memory of this unit is full.	Station your iPod/iPhone in the Universal Dock for iPod (YDS-12) connected to the DOCK terminal of this unit.	—
iPod full Tags cannot be stored	Tag data cannot be stored on your iPod/iPhone because the HDD space of your iPod/iPhone is full.	Delete unnecessary data from your iPod/iPhone with iTunes to make room and try again.	—
Transferring Failed	Tag data cannot be transferred to your iPod/iPhone.	Check if the iPod/iPhone is stationed in the Universal Dock for iPod (YDS-12) properly.	—
Storing Tag	Tag data is being stored in the internal memory of this unit.		—
Transferring	Tag data is being transferred to your iPod/iPhone.		—
Tag(s)Sent	Tag data has been transferred to your iPod/iPhone.		—

SIRIUS Satellite Radio™

Problem	Cause	Remedy	See page
SIRIUS Satellite Radio information is not displayed properly.	The hold function is enabled.	Press HOLD to disable the hold function.	78

Display	Cause	Remedy	See page
ANTENNA ERROR	The antenna is not connected to the SiriusConnect tuner properly.	Check the connection of the antenna and SiriusConnect tuner.	74
SIRIUS LOADING	This unit is communicating with the SiriusConnect tuner.	The message disappears normally within several tens of seconds.	—
CHECK SR TUNER	The SiriusConnect tuner is not connected to the SIRIUS jack of this unit correctly.	Check the connection of the SiriusConnect tuner and this unit.	74
	The SiriusConnect tuner is not connected to the AC wall outlet.	Connect the power cable of the SiriusConnect tuner to the AC wall outlet.	—
NOT SUPPORTED	This unit does not support the connected SIRIUS Satellite Radio tuner.	Connect the SiriusConnect tuner that this unit supports,	—
ACQUIRING	The signal is too weak.	Adjust the orientation of the antenna of the SiriusConnect tuner. Check the antenna reception level from the Antenna information on the front panel display, or the SIRIUS Information screen on the TV screen.	77, 78
UPDATING	The SiriusConnect tuner is updating the channel list.	Wait until the updating is complete.	—
	The period of the subscription is end.	Contact SIRIUS Satellite Radio to renew the subscription.	—
F/W UPDATING	The SiriusConnect tuner is updating the firmware.	Wait until the updating is complete.	—



Display	Cause	Remedy	See page
CALL SIRIUS (CALL 888-539-SIRIUS TO SUBSCRIBE)	The selected channel is not subscribed.	Contact SIRIUS Satellite Radio to subscribe the selected channel. URL: https://activate.siriusradio.com/ Phone: 1-888-539-SIRIUS (1-888-539-7474)	—
		Select another channel.	75
SUB UPDATED	The subscription information is updated.		
LOCK	The parental lock function is enabled.	Use Numeric keys to enter the 4-digit code, select OK and then press ENT .	79
		Reset the SIRIUS Satellite Radio parental lock code to the factory default setting.	146
INVALID	The selected channel is currently out of service.	Select another channel.	75
Not Available	The operation you made is not available.		

USB and Network

Problem	Cause	Remedy	See page
“No Device” is displayed even when a USB device is present.	This unit recognized the USB storage device as an illegal device.	Turn this unit off then on again.	—
The music files and directories in the USB device cannot be viewed.	The music files and directories are placed in locations other than the FAT area.	Place music files and directories in the FAT area.	—
	You are attempting to browse directory hierarchies of over 8 levels or a directory with more than 500 files.	Modify the data structure on your USB device.	—
The PC server/ Internet Radio does not function properly.	The IP address is not set properly.	Set the DHCP server function of the router to ON. Alternately, perform manual configuration according to the current operating environment.	125
	The network cable is not connected.	Connect it properly.	40
The music in the PC server cannot be played back.	The PC does not have Windows Media Player installed in it.	Install Windows Media Player in the PC.	—
	The music is recorded in a format that cannot be played on this unit. This unit cannot play music formats other than WMA, MP3, MPEG-4 AAC, FLAC, and WAV (PCM format). Also note that it cannot play certain music files even if these are recorded in the WMA, MP3, MPEG-4 AAC, FLAC, or WAV format.	Play music recorded in a format that this unit is compatible with.	—



Problem	Cause	Remedy	See page
The Internet Radio cannot be played.	The firewall of the network device is activated. The Internet Radio can be played only when it passes through the port designated by each radio station. The port number is variable depending on radio station.	Check the firewall setting of the network device.	—
	Connection to the Internet is disconnected.	Check the configuration of the network device, and then contact the network connection provider.	—

Display	Cause	Remedy	See page
Connect error	There is a problem with the signal path from your network to this unit.	Check the connection between this unit and the LAN port on your router or hub.	40
		Make sure your router is properly connected and turned on. Also, make sure your modem is properly connected and turned on when you are attempting to listen to Internet Radio.	40
Disconnected	Your USB storage device or USB portable audio player has been disconnected from the USB port of this unit.	Check the connection between this unit and your USB storage device or USB portable audio player.	—
	The PC server previously connected to this unit no longer exists.	Connect this unit to the available PC server.	40
No Device	There is a problem with the signal path from your USB storage device or USB portable audio player to this unit.	Turn off this unit and reconnect your USB storage device or USB portable audio player to the USB port of this unit.	41
		Try resetting your USB storage device or USB portable audio player.	—

Display	Cause	Remedy	See page
Access error	This unit cannot access your USB storage device or USB portable audio player.	Try another USB storage device or USB portable audio player.	—
	There is a problem with the signal path from your USB storage device or USB portable audio player to this unit.	Turn off this unit and reconnect your USB storage device or USB portable audio player to the USB port of this unit. Try resetting your USB storage device or USB portable audio player.	41 —
Access denied	The PC you are attempting to connect has denied connection.	Configure the sharing setting of Window Media Player 11/12 and select this unit as a device to which music contents are shared.	80
Unable to Play	This unit cannot play back the songs currently stored on your PC.	Make sure Windows Media Player is installed on your PC.	—
		Check that the songs currently stored on your PC are playable (MP3, WMA, MPEG-4 AAC, and WAV).	—
		Store some other playable music files (MP3, WMA, MPEG-4 AAC, and WAV) on your PC.	—
	The network may be overloaded with heavy traffic, and playback is interrupted.	Try preparing a network exclusively for use with this unit to separate it from general network traffic.	—
List updated	The list of the contents stored on your PC server has been updated.		—
Bookmark On	The desired Internet Radio station has been added to the Bookmarks list.		—
Bookmark Off	The stored Internet Radio station has been removed from the Bookmarks list.		—
USB Overloaded	Over current passes through the connected USB device.	Turn off this unit and then disconnect the USB device. If the message appears when you connect the USB device again, this unit may not compatible with the USB device.	—



iPod™/iPhone™

Display	Cause	Remedy	See page
Loading...	The unit is in the process of recognizing the connection with your iPod/iPhone.		—
	The unit is in the middle of acquiring song lists from your iPod/iPhone.		—
Connect error	There is a problem with the signal path from your iPod/iPhone to the unit.	Turn off the unit and reconnect the Universal Dock for iPod to the DOCK jack of the unit.	94
		Remove your iPod/iPhone from the Universal Dock for iPod and then place it back in the dock.	94
Unknown iPod	The iPod/iPhone being used is not supported by the unit.	Connect an iPod/iPhone supported by the unit.	—
iPod connected	Your iPod/iPhone is properly placed in the Universal Dock for iPod.		—
	Your iPod/iPhone is properly placed in the Yamaha transmitter of the Yamaha Wireless System for iPod and connected with this unit via wireless transmission.		96
Disconnected	Your iPod/iPhone is removed from the Universal Dock for iPod.		—
	Your iPod/iPhone is disconnected with this unit via wireless transmission.		—
Unable to play	The unit cannot playback the songs currently stored on your iPod/iPhone.	Check that songs are currently stored on your iPod/iPhone.	—

Bluetooth™

Display	Cause	Remedy	See page
Searching...	The Yamaha Bluetooth Wireless Audio Receiver and the Bluetooth component are in the process of pairing.		—
	The Yamaha Bluetooth Wireless Audio Receiver and the Bluetooth component are in the process of establishing a connection.		—
Completed	The pairing is completed.		—
Canceled	The pairing is canceled.		—
BT connected	The connection between the Yamaha Bluetooth Wireless Audio Receiver and the Bluetooth component is established.		—
Disconnected	The Bluetooth component is disconnected from the Yamaha Bluetooth Wireless Audio Receiver.		—
Not found	The Bluetooth component is not found.	During pairing: – pairing must be performed on the Bluetooth component and this unit simultaneously. Check if the Bluetooth component is in pairing mode.	—
		During connecting: – check if the Bluetooth component is turned on. – check if the Bluetooth component is within 32 ft. (10 m) of the Yamaha Bluetooth Wireless Audio Receiver.	
	Pairing may not have been achieved.	Try pairing again.	98



Remote control

Problem	Cause	Remedy	See page
The remote control does not work or function properly.	Wrong distance or angle.	The remote control will function within a maximum range of 20 ft. (6 m), and no more than 30 degrees off-axis from the front panel.	—
	Direct sunlight or lighting (from an inverter type of fluorescent lamp, strobe light, etc.) is striking the remote control sensor of this unit.	Adjust the lighting angle, or reposition this unit.	—
	The batteries are weak.	Replace all batteries.	13
	The remote control ID of the remote control and this unit do not match.	Match the remote control ID of this unit and the remote control.	135 , 145
The battery of remote control runs out immediately.	The power of battery is not enough.	Replace the battery with alkaline battery.	—
External components cannot be controlled using the remote control.	The remote control code is not correctly set.	Set the remote control code correctly using " Remote control code search " on the CD-ROM.	—
		Try setting another code for the same manufacturer using " Remote control code search " on the CD-ROM.	—
		If this unit does not work when you press Cursor $\Delta / \nabla / \triangleleft / \triangleright$, do the following. When the key does not work during DVD disc menu operation: press the Input selector again. When there is no response with remote control operation of the Option menu/Setup menu: press SOURCE/RECEIVER (it should glow orange) and try operating the remote control again.	—
Even if the remote control code is correctly set, there are some models that do not respond to the remote control.			—



Glossary

Audio information

Audio and video synchronization (Lipsync)

Lip sync, an abbreviation for lip synchronization, is a technical term that involves both a problem and a capability of maintaining audio and video signals synchronized during post-production and transmission. Whereas the audio and video latency requires complex end-user adjustments, HDMI version 1.3 incorporates an automatic audio and video syncing capability that allows devices to perform this synchronization automatically and accurately without user interaction.

Bi-amplification connection (Bi-amp)

A bi-amplification connection uses two amplifiers for a speaker. One amplifier is connected to the woofer section of a loudspeaker while the other is connected to the combined mid and tweeter section. With this arrangement each amplifier operates over a restricted frequency range. This restricted range presents each amplifier with a much simpler job and each amplifier is less likely to influence the sound in some way.

Dolby Digital

Dolby Digital is a digital surround sound system that gives you completely independent multi-channel audio. With 3 front channels (front L/R and center), and 2 surround stereo channels, Dolby Digital provides 5 full-range audio channels. With an additional channel especially for bass effects, called LFE (Low Frequency Effect), the system has a total of 5.1-channels (LFE is counted as 0.1 channel). By using 2-channel stereo for the surround speakers, more accurate moving sound effects and surround sound environment are possible than with Dolby Surround. The wide dynamic range from maximum to minimum volume reproduced by the 5 full-range channels and the precise sound orientation generated using digital sound processing provide listeners with unprecedented excitement and realism. With this unit, any sound environment from monaural up to a 5.1-channel configuration can be freely selected for your enjoyment.

Dolby Digital Surround EX

Dolby Digital EX creates 6 full-bandwidth output channels from 5.1-channel sources. For the best results, Dolby Digital EX should be used with movie sound tracks recorded with Dolby Digital Surround EX. With this additional channel, you can experience more dynamic and realistic moving sound especially with scenes with “fly-over” and “flyaround” effects.

Dolby Digital Plus

Dolby Digital Plus is an advanced audio technology developed for high-definition programming and media including HD broadcasts, and Blu-ray Disc. Selected as an optional audio standard for Blu-ray Disc, this technology delivers multichannel sound with discrete channel output. Supporting bitrates up to 6.0 Mbps, Dolby Digital Plus can carry up to 7.1 discrete audio channels simultaneously. Supported by HDMI version 1.3 and designed for the optical disc players and AV receivers/amplifiers of the future, Dolby Digital Plus also remains fully compatible with the existing multichannel audio systems that incorporate Dolby Digital.

Dolby Pro Logic II

Dolby Pro Logic II is an improved technique used to decode vast numbers of existing Dolby Surround sources. This new technology enables a discrete 5-channel playback with 2 front left and right channels, 1 center channel, and 2 surround left and right channels, instead of only 1 surround channel for conventional Pro Logic technology. There are three modes available: “Music mode” for music sources, “Movie mode” for movie sources, and “Game mode” for game sources.

Dolby Pro Logic IIx

Dolby Pro Logic IIx is a new technology enabling discrete multichannel playback from 2-channel or multi-channel sources. There are three modes available: “Music mode” for music sources, “Movie mode” for movie sources (for 2-channel sources only) and “Game mode” for game sources.

Dolby TrueHD

Dolby TrueHD is an advanced lossless audio technology developed for high-definition disc-based media including Blu-ray Disc. Selected as an optional audio standard for Blu-ray Disc, this technology delivers sound that is bit-for-bit identical to the studio master, offering a high-definition home theater experience. Supporting bitrates up to 18.0 Mbps, Dolby TrueHD can carry up to 8 discrete channels of 24-bit/96 kHz audio simultaneously. Dolby TrueHD also remains fully compatible with the existing multichannel audio systems and retains the metadata capability of Dolby Digital, allowing dialog normalization and dynamic range control.

DTS 96/24

DTS 96/24 offers an unprecedented level of audio quality for multichannel sound on DVD video, and is fully backward-compatible with all DTS decoders. “96” refers to a 96 kHz sampling rate compared to the typical 48 kHz sampling rate. “24” refers to 24-bit word length. DTS 96/24 offers sound quality transparent to the original 96/24 master, and 96/24 5.1-channel sound with full-quality full-motion video for music programs and motion picture soundtracks on DVD video.

DTS Digital Surround

DTS digital surround was developed to replace the analog soundtracks of movies with a 5.1-channel digital sound track, and is now rapidly gaining popularity in movie theaters around the world. DTS, Inc. has developed a home theater system so that you can enjoy the depth of sound and natural spatial representation of DTS digital surround in your home. This system produces practically distortion-free 6-channel sound (technically, front left and right, center, surround left and right, and LFE 0.1 (subwoofer) channels for a total of 5.1 channels). This unit incorporates a DTS-ES decoder that enables 6.1-channel reproduction by adding the surround back channel to the existing 5.1-channel format.

DTS Express

This is an audio format for next-generation optical discs such as Blu-ray discs. It uses optimized low bit rate signals for network streaming. In the case of a Blu-ray disc, this format is used with secondary audio, enabling you to enjoy the commentary of the movie producer via the Internet while playing the main program.

DTS-HD High Resolution Audio

DTS-HD High Resolution Audio is a high resolution audio technology developed for high-definition disc-based media including Blu-ray Disc. Selected as an optional audio standard for Blu-ray Disc, this technology delivers sound that is virtually indistinguishable from the original, offering a high-definition home theater experience.

Supporting bitrates up to 6.0 Mbps for Blu-ray Disc, DTS-HD High Resolution Audio can carry up to 7.1 discrete channels of 24-bit/96 kHz audio simultaneously.

DTS-HD High Resolution Audio also remains fully compatible with the existing multichannel audio systems that incorporate DTS Digital Surround.



DTS-HD Master Audio

DTS-HD Master Audio is an advanced lossless audio technology developed for high-definition disc-based media including Blu-ray Disc. Selected as an optional audio standard for Blu-ray Disc, this technology delivers sound that is bit-for-bit identical to the studio master, offering a high-definition home theater experience.

Supporting bitrates up to 24.5 Mbps for Blu-ray Disc, DTS-HD Master Audio can carry up to 7.1 discrete channels of 24-bit/96 kHz audio simultaneously. Supported by HDMI version 1.3 and designed for the optical disc players and AV receivers/amplifiers of the future, DTS-HD Master Audio also remains fully compatible with the existing multichannel audio systems that incorporate DTS Digital Surround.

DTS Neo:6

Neo:6 decodes the conventional 2-channel sources for 6-channel playback by the specific decoder. It enables playback with the fullrange channels with higher separation just like digital discrete signal playback. There are two modes available: "Music mode" for music sources and "Cinema mode" for movie sources.

DSD

Direct Stream Digital (DSD) technology stores audio signals on digital storage media, such as Super Audio CDs. Using DSD, signals are stored as single bit values at a high-frequency sampling rate of 2.8224 MHz, while noise shaping and oversampling are used to reduce distortion, a common occurrence with very high quantization of audio signals. Due to the high sampling rate, better audio quality can be achieved than that offered by the PCM format used for normal audio CDs. The frequency is equal to or higher than 100 kHz and the dynamic range is 120 dB. This unit can transmit or receive DSD signals input from the HDMI jack.

FLAC

This is a file format for lossless audio data compression. FLAC is inferior to lossy compression formats in compression rate but provides higher audio quality.

MP3

One of the audio compression methods used by MPEG. It employs the irreversible compression method, which achieves a high compression rate by thinning out the data of hardly audible part to the human ears. It is said to be capable of compressing the data quantity by about 1/11 (128 kbps) while maintaining a similar audio quality to music CD.

MPEG-4 AAC

An MPEG-4 audio standard. As it allows compression of data at a bit rate lower than that of MPEG-2 AAC, it is used among others for mobile telephones, portable audio players and other low-capacity devices requiring high sound quality. In addition to the above types of devices, MPEG-4 AAC is also used to distribute contents on the Internet, and as such is supported by computers, media servers and many other devices.

LFE 0.1 channel

This channel reproduces low-frequency bass signals, and has a frequency range from 20 Hz to 120 Hz. This channel is counted as 0.1, because it only enforces a low-frequency range compared to the full-range reproduced by the other 5-channels in Dolby Digital or DTS 5.1-channel systems.

PCM (Linear PCM)

Linear PCM is a signal format under which an analog audio signal is digitized, recorded and transmitted without using any compression. This is used as a method of recording CDs and DVD audio. The PCM system uses a technique for sampling the size of the analog signal per very small unit of time. Standing for "Pulse Code Modulation," the analog signal is encoded as pulses and then modulated for recording.

Sampling frequency and number of quantized bits

When digitizing an analog audio signal, the number of times the signal is sampled per second is called the sampling frequency, while the degree of fineness when converting the sound level into a numeric value is called the number of quantized bits. The range of rates that can be played back is determined based on the sampling rate, while the dynamic range representing the sound level difference is determined by the number of quantized bits. In principle, the higher the sampling frequency, the wider the range of frequencies that can be played back, and the higher the number of quantized bits, the more finely the sound level can be reproduced.

WAV

Windows standard audio file format, which defines the method of recording the digital data obtained by converting audio signals. It does not specify the compression (coding) method so a desired compression method can be used with it. By default, it is compatible with the PCM method (no compression) and some compression methods including the ADPCM method.

WMA

An audio compression method developed by Microsoft Corporation. It employs the irreversible compression method, which achieves a high compression rate by thinning out the data of hardly audible part to the human ears. It is said to be capable of compressing the data quantity by about 1/22 (64 kbps) while maintaining a similar audio quality to music CD.

Sound program information**CINEMA DSP**

Since the Dolby Surround and DTS systems were originally designed for use in movie theaters, their effect is best felt in a theater having many speakers designed for acoustic effects. Since home conditions, such as room size, wall material, number of speakers, and so on, can differ so widely, it is inevitable that there are differences in the sound that is heard. Based on a wealth of actually measured data, Yamaha CINEMA DSP uses Yamaha's original DSP technology to combine Dolby Pro Logic, Dolby Digital, and DTS systems to provide the audiovisual experience of a movie theater in the listening room of your own home.

CINEMA DSP 3D

The actually measured sound field data contain the information of the height of the sound images. CINEMA DSP 3D feature achieves the reproduction of the accurate height of the sound images so that it creates the accurate and intensive stereoscopic sound fields in a listening room.

Compressed music enhancer

The Compressed music enhancer feature of this unit enhances your listening experience by regenerating the missing harmonics in compression artifacts. As a result, it compensates for flattened complexity due to the loss of high-frequency fidelity as well as lack of bass due to the loss of low-frequency bass, providing improved performance for the overall sound system.

SILENT CINEMA

Yamaha has developed a natural, realistic sound effect DSP algorithm for headphones. Parameters for headphones have been set for each sound program, so that accurate representations of all the sound programs can be enjoyed on headphones.

Virtual CINEMA DSP

Yamaha has developed a Virtual CINEMA DSP algorithm that allows you to enjoy DSP surround effects even without any surround speakers, by using virtual surround speakers. It is even possible to enjoy Virtual CINEMA DSP using a minimal two-speaker system that does not include a center speaker.



Video information

Component video signal

With the component video signal system, the video signal is separated into the Y signal for luminance and the Pb and Pr signals for chrominance. Color can be reproduced more faithfully with this system because each of these signals is independent. The component signal is also called the “color difference signal” because the luminance signal is subtracted from the color signal. A monitor with component input jacks is required in order to output component signals.

Composite video signal

With the composite video signal system, the video signal comprises the three basic elements of a video picture: color, brightness and synchronization data. A composite video jack on a video component transmits these three elements combined.

Deep Color

Deep Color refers to the use of various color depths in displays, up from the 24-bit depths in previous versions of the HDMI specification. This extra bit depth allows HDTVs and other displays go from millions of colors to billions of colors and eliminate on-screen color banding for smooth tonal transitions and subtle gradations between colors. The increased contrast ratio can represent many times more shades of gray between black and white. Also, Deep Color increases the number of available colors within the boundaries defined by the RGB or YCbCr color space.

HDMI

HDMI (High-Definition Multimedia Interface) is the first industry supported, uncompressed, all-digital audio/video interface. Providing an interface between any sources (such as set-top boxes or AV receivers) and audio/video monitor (such as digital television), HDMI supports standard, enhanced or high-definition video as well as multichannel digital audio using a single cable. HDMI transmits all ATSC HDTV standards and supports 8-channel digital audio, with bandwidth to spare to accommodate future enhancements and requirements.

When used in combination with HDCP (High-bandwidth Digital Content Protection), HDMI provides a secure audio/video interface that meets the security requirements of content providers and system operators. For further information on HDMI, visit the HDMI website at “<http://www.hdmi.org/>.”

S-video signal

With the S-video signal system, the video signal normally transmitted using a pin cable is separated and transmitted as the Y signal for the luminance and the C signal for the chrominance through the S-video cable. Using the S-VIDEO jack eliminates video signal transmission loss and allows recording and playback of even more beautiful images.

“x.v.Color”

A color space standard supported by HDMI version 1.3. It is a more extensive color space than sRGB, and allows the expression of colors that could not be expressed before. While remaining compatible with the color gamut of sRGB standards, “x.v.Color” expands the color space, and can thus produce more vivid, natural images. It is particularly effective for still pictures and computer graphics.

Compatibility of the input and output video signals

Analog-to-HDMI video conversion is performed according to resolution of video signals as shown below. Analog-to-analog video conversion is also possible when “Analog to Analog Conversion” is set to “On” ([p. 121](#)).

✓: available conversion

	Resolution	HDMI output					COMPONENT VIDEO output				S-VIDEO output	VIDEO output
		480i/576i	480p/576p	720p	1080i	1080p	480i/576i	480p/576p	720p	1080i	480i/576i	480i/576i
HDMI input	480i/576i	✓	✓	✓	✓	✓						
	480p/576p		✓	✓	✓	✓						
	720p		✓	✓	✓	✓						
	1080i		✓	✓	✓	✓						
	1080p		✓	✓	✓	✓						
COMPONENT VIDEO input	480i/576i	✓	✓	✓	✓	✓	✓				✓	✓
	480p/576p		✓	✓	✓	✓		✓				
	720p		✓	✓	✓	✓			✓			
	1080i		✓	✓	✓	✓				✓		
S-VIDEO input	480i/576i	✓	✓	✓	✓	✓	✓			✓	✓	
VIDEO input	480i/576i	✓	✓	✓	✓	✓	✓			✓	✓	



Information on HDMI™

■ HDMI signal compatibility

Audio signals

Audio signal types	Audio signal formats	Compatible media
2ch Linear PCM	2ch, 32-192 kHz, 16/20/24 bit	CD, DVD-Video, DVD-Audio, etc.
Multi-ch Linear PCM	8ch, 32-192 kHz, 16/20/24 bit	DVD-Audio, Blu-ray Disc, HD DVD, etc.
DSD	2/5.1ch, 2.8224 MHz, 1 bit	SACD, etc.
Bitstream	Dolby Digital, DTS	DVD-Video, etc.
Bitstream (High definition audio)	Dolby TrueHD, Dolby Digital Plus, DTS-HD Master Audio, DTS-HD High Resolution Audio, DTS Express	Blu-ray Disc, HD DVD, etc.

- If the input source component can decode the bitstream audio signals of audio commentaries, you can playback the audio sources with the audio commentaries mixed down by using the digital audio input (optical or coaxial) connections.
- Refer to the supplied instruction manuals of the input source component, and set the component appropriately.

NOTES

- When CPPM copy-protected DVD-Audio is played back, video and audio signals may not be output, depending on the type of the DVD player.
- This unit is not compatible with HDCP-incompatible HDMI or DVI components.
- Refer to the supplied instruction manuals for details.
To decode audio bitstream signals on this unit, set the input source component appropriately so that the component outputs the bitstream audio signals directly (does not decode the bitstream signals on the component).
- This unit is not compatible with the audio commentary features (for example, the special audio contents downloaded via Internet) of Blu-ray Disc or HD DVD. This unit does not playback the audio commentaries of the Blu-ray Disc or HD DVD content.

Video signals

This unit is compatible with the video signals of the following resolutions:

- 480i/60 Hz
- 576i/50 Hz
- 480p/60 Hz
- 576p/50 Hz
- 720p/60 Hz, 50 Hz
- 1080i/60 Hz, 50 Hz
- 1080p/60 Hz, 50 Hz, 24 Hz



About trademarks



Manufactured under license from Dolby Laboratories. Dolby, Pro Logic and the double-D symbol are trademarks of Dolby Laboratories.



Manufactured under license under U.S. Patent #'s: 5,451,942; 5,956,674; 5,974,380; 5,978,762; 6,226,616; 6,487,535; 7,212,872; 7,333,929; 7,392,195; 7,272,567 & other U.S. and worldwide patents issued & pending. DTS and the Symbol are registered trademarks, & DTS-HD, DTS-HD Master Audio, and the DTS logos are trademarks of DTS, Inc. Product includes software. © DTS, Inc. All Rights Reserved.

iPod™, iPhone™

“iPod” is a trademark of Apple Inc., registered in the U.S. and other countries. “iPhone” is a trademark of Apple Inc.



Fraunhofer Institut
Integrierte Schaltungen

MPEG Layer-3 audio coding technology licensed from Fraunhofer IIS and Thomson.



This receiver supports network connections.



HD Radio™ Technology Manufactured Under License From iBiquity Digital Corp. U.S. and Foreign Patents. HD Radio™ and the HD Radio logo are proprietary trademarks of iBiquity Digital Corp.

Bluetooth™

Bluetooth is a registered trademark of the Bluetooth SIG and is used by Yamaha in accordance with a license agreement.



HIGH DEFINITION MULTIMEDIA INTERFACE

“HDMI,” the “HDMI” logo and “High-Definition Multimedia Interface” are trademarks, or registered trademarks of HDMI Licensing LLC.

x.v.Color™

“x.v.Color” is a trademark of Sony Corporation.



“SILENT CINEMA” is a trademark of Yamaha Corporation.



SIRIUS, XM and all related marks and logos are trademarks of Sirius XM Radio Inc. and its subsidiaries. All rights reserved. **Service not available in Alaska and Hawaii.**



Rhapsody and the Rhapsody logo are registered trademarks of RealNetworks, Inc.

Windows XP, Windows Vista, Windows 7, Windows Media Audio, Windows Media Connect and Windows Media Player are either registered trademarks or trademarks of Microsoft Corporation in the United States and/or other countries.

Specifications

■ Input			
• Analog Audio			
RCA	10		
AV1-4, AUDIO1-4, PHONO, VIDEO AUX			
MULTI CH INPUT	8ch		
FRONT L/R, CENTER, SURROUND L/R, SURROUND BACK L/R, SUBWOOFER			
• Digital Audio			
Optical	4 (AV3-4, AUDIO1, VIDEO AUX)		
Coaxial	3 (AV1-2, AUDIO2)		
• Analog Video			
Composite	5 (AV1-4, VIDEO AUX)		
S-video	5 (AV1-4, VIDEO AUX)		
Component	4 (AV1-4)		
• Other			
DOCK	1 (Audio L/R, Composite Video, S-video)		
■ Output			
• Analog Audio			
SPEAKERS	11ch (7ch + Extra 4ch)		
FRONT L/R, CENTER, SURROUND L/R, SURROUND BACK/BI-AMP L/R, EXTRA SP1 (ZONE2/ZONE3/F.PRESENCE L/R), EXTRA SP2 (ZONE2/ZONE3/R.PRESENCE L/R)			
PRE OUT	9ch		
FRONT/F.PRESENCE L/R, CENTER, SURROUND L/R, SURROUND BACK L/R, R.PRESENCE L/R*			
*: Barter to Zone3			
SUBWOOFER (Stereo, Front & Rear 2ch)			
AV OUT	1		
ZONE2 OUT	1		
ZONE3/R.PRESENCE OUT	1		
• Digital Audio			
Optical	1 (AV OUT/ZONE4 OUT)		
• Analog Video			
MONITOR OUT/ZONE OUT			
Composite	1		
S-video	1		
Component	1		
		AV OUT	
		Composite	1
		S-video	1
■ HDMI			
• Input	8 (AV1-7, VIDEO AUX)		
• Output	2 (HDMI OUT)		
• HDMI Specification			
Deep Color 30/36 bit, "x.v.Color," Auto Lips Sync, HD Audio, ARC (Audio Return Channel), 3D			
• Audio Format			
Dolby Digital, DTS, DSD 6ch, Dolby Digital Plus, Dolby TrueHD, DTS-HD, PCM 2ch-8ch			
• Content Protection	HDCP compatible		
■ Tuner			
• Analog Tuner			
FM/AM	1 (TUNER)		
• [U.S.A. model] HD Radio with iTunes Tagging	1 (TUNER)		
• [U.S.A. model] Satellite Radio Ready			
SIRIUS Radio	1 (SIRIUS)		
■ Network			
• USB (USB1.1 Full Speed)	1		
Device Type	USB Mass Storage Class, MTP		
Audio Format	MP3, WMA, WAV, MPEG-4 AAC, FLAC		
Max Audio Support fs	48 kHz/24 bit		
Cover Art Format	PNG, JPEG		
• Ethernet (100Base-TX/10Base-TX)	1		
Internet Radio			
Audio Format	MP3, WMA		
PC Server			
Audio Format	MP3, WMA, WAV, MPEG-4 AAC, FLAC		
Max Audio Support fs	96 kHz/24 bit		
Cover Art Format	PNG, JPEG		
■ DLNA			
Version	1.5 (DMP & DMR support)		
Audio Format	MP3, WMA, WAV, MPEG-4 AAC, FLAC		
Max Audio Support fs	96 kHz/24 bit		
Cover Art Format	PNG, JPEG		
[U.S.A. model] Internet Music Service			
Rhapsody, Sirius Internet Radio			
Network Control			
Web Browse Control, MusicCAST2 Commander Support, Yamaha Network Control Support (YNC), Receiver Manager Support			
■ Remote			
• RS-232C	1		
• REMOTE IN	2		
• REMOTE OUT	2		
• TRIGGER OUT	2 (12 V/total 100 mA max.)		
■ Compatible Decoding Format			
• Decoding Format			
Dolby TrueHD, Dolby Digital Plus, Dolby Digital, Dolby Digital EX, DTS-HD Master Audio, DTS-HD High Resolution Audio, DTS Express, DTS, DTS-ES Matrix 6.1, DTS-ES Discrete 6.1, DTS 96/24			
• Post Decoding Format			
Dolby Pro Logic, Dolby Pro Logic II Music, Dolby Pro Logic II Movie, Dolby Pro Logic II Game, Dolby Pro Logic IIx Music, Dolby Pro Logic IIx Movie, Dolby Pro Logic IIx Game, DTS Neo:6 Music, DTS Neo:6 Cinema			
■ Audio Section			
• Minimum RMS Output Power (20 Hz to 20 kHz, 0.06 % THD, 8 Ω)			
FRONT L/R	140 W + 140 W		
CENTER	140 W		
SURROUND L/R	140 W + 140 W		
SURROUND BACK L/R	140 W		
• Dynamic Power (IHF)			
FRONT L/R, 8/6/4/2 Ω	175/220/295/415 W		



- Dynamic Headroom
 - 8 Ω 1.0 dB
- Damping Factor
 - FRONT L/R, 1 kHz, 8 Ω 150 or more
- Input Sensitivity/Input Impedance
 - PHONO 3.5 mV/47 kΩ
 - AUDIO2 etc. 200 mV/47 kΩ
 - MULTI CH IN 200 mV/47 kΩ
- Maximum Input Level
 - PHONO (1 kHz, 0.1 % THD) 60 mV or more
 - AUDIO2 etc. (1 kHz, 0.5 % THD) 2.4 V or more
- Output Level/Output Impedance
 - AV OUT 200 mV/1.2 kΩ
 - HEADPHONE OUT 150 mV/100 Ω
 - PRE OUT 1.0 V/1.2 kΩ
 - ZONE2 OUT 1.0 V/1.2 kΩ
 - ZONE3/R.PRESENCE OUT 1.0 V/1.2 kΩ
- Frequency Response
 - AUDIO2 etc. to FRONT L/R
(Pure Direct, 10 Hz to 100 kHz) +0/-3 dB
- Total Harmonic Distortion
 - PHONO to AV OUT (20 Hz to 20 kHz, 1 V) 0.02 % or less
 - AV1 to FRONT L/R (20 Hz to 20 kHz, 70 W/8 Ω) ... 0.04 % or less
- Signal to Noise Ratio (IHF-A Network)
 - PHONO (input shorted, 5 mV) to AV OUT
[U.S.A and Canada models] 86 dB or more
 - [Australia models] 81 dB or more
 - AUDIO2 etc. (input shorted, 250 mV) to FRONT L/R
..... 100 dB or more
- Residual Noise (IHF-A Network)
 - FRONT L/R 150 μV or less
- Channel Separation (1 kHz/10 kHz)
 - PHONO (input shorted) 60 dB/55 dB or more
 - AV1 etc. (input 5.1 kΩ shorted) 60 dB/45 dB or more
- Volume Control
 - Main Zone MUTE/-80 to +16.5 dB
 - Zone2, Zone3 MUTE/-80 to +16.5 dB

- Tone Control Characteristics
 - Main Zone (FRONT, CENTER, SUBWOOFER)
 - Bass Boost/Cut ±6 dB/50 Hz
 - Bass Turnover Frequency 350 Hz
 - Treble Boost/Cut ±6 dB/20 kHz
 - Treble Turnover Frequency 3.5 kHz
 - Zone2, Zone3
 - Bass Boost/Cut ±10 dB/100 Hz
 - Bass Turnover Frequency 350 Hz
 - Treble Boost/Cut ±10 dB/10 kHz
 - Treble Turnover Frequency 3.5 kHz
- Filter Characteristics (fc=40/60/80/90/100/110/120/160/200 Hz)
 - H.P.F. (FRONT, CENTER, SURROUND, SURROUND BACK:
Small) 12 dB/oct.
 - L.P.F. (SUBWOOFER) 24 dB/oct.

■ Video Section

- Video Format (MONITOR OUT/ZONE OUT, Wall Paper/OSD)
 - [U.S.A. and Canada models] NTSC/PAL
 - [Australia model] PAL/NTSC
- Video Signal Type (Video Conversion) NTSC/PAL
- Signal Level
 - Composite 1 Vp-p/75 Ω
 - S-video
 - NTSC 1 Vp-p/75 Ω (Y), 0.286 Vp-p/75 Ω (C)
 - PAL 1 Vp-p/75 Ω (Y), 0.3 Vp-p/75 Ω (C)
 - Component 1 Vp-p/75 Ω (Y), 0.7 Vp-p/75 Ω (PB/PR)
- Maximum Input Level (Video Conversion Off) 1.5 Vp-p or more
- Signal to Noise Ratio (Video Conversion Off) 60 dB or more
- Frequency Response (Video Conversion Off)
 - Component (MONITOR OUT/ZONE OUT)
..... 5 Hz to 100 MHz, ±3 dB

■ FM Section

- Tuning Range
 - [U.S.A. and Canada models] 87.5 to 107.9 MHz
 - [Australia model] 87.50 to 108.00 MHz
- 50 dB Quieting Sensitivity (IHF)
 - Mono 3.0 μV (20.8 dBf)
- Signal to Noise Ration (IHF)
 - Mono/Stereo 74 dB/70 dB
 - [U.S.A. model] HD 80 dB
- Harmonic Distortion (1 kHz)
 - Mono/Stereo 0.3 %/0.3 %
 - [U.S.A. model] HD 0.03 %
- Antenna Input 75 Ω (unbalanced)

■ AM Section

- Tuning Range
 - [U.S.A. and Canada models] 530 to 1710 kHz
 - [Australia model] 531 to 1611 kHz

■ General

- Power Supply
 - [U.S.A. and Canada models] AC 120 V, 60 Hz
 - [Australia model] AC 240 V, 50 Hz
- Power Consumption
 - [U.S.A. model] 490 W/620 VA
 - [Canada model] 400 W/510 VA
 - [Australia model] 490 W
- Standby Power Consumption
 - HDMI Control Off/Standby Through Off 0.3 W or less
 - HDMI Control On/Standby Through On 2.7 W (typical)
 - NET Standby On 4.5 W (typical)
- Dimensions (W x H x D)
 - 435 x 182 x 430 mm (17-1/8 x 7-1/8 x 16-7/8 in)
- Weight 17.0 kg (37.5 lbs.)



Index

Numerics

2ch stereo playback.....	57
5 channel speaker layout.....	18
5.1-channel speaker layout.....	17
7.1-channel speaker connection.....	20
7.1-channel speaker layout.....	16

A

Account Status, Input menu.....	104
Adaptive DRC, Option menu.....	64
Adaptive DSP Level, Sound setup.....	121
Advanced Setup menu.....	144
Advanced speaker configuration.....	24
All channel search mode.....	76
AM antenna connection.....	42
AM tuning.....	67
Analog to Analog Conversion, Video setup.....	121
ARC (Audio Return Channel), HDMI setup.....	123
Aspect, Processing, Video setup.....	122
AUDIO jack.....	29
Audio Mode.....	69, 73
Audio Output, HDMI setup.....	124
Audio Return Channel function.....	150
Audio Select, Option menu.....	65
Audio Signal, Information menu.....	132
Auto Power Down, Function setup.....	129
Auto Preset.....	69, 73
Auto Setup, Speaker setup.....	115

B

Basic playback.....	52
BD player connection.....	33
Bi-amp connection, speaker.....	21
Bluetooth™ component playback.....	98
Bookmark Off, Internet Radio.....	84
Bookmark On, Internet Radio.....	84
Browse view.....	66

C

Cable plug.....	29
Category search mode.....	76
Center Image, Sound Program menu.....	113
Center Level, Sound Program menu.....	112
Center speaker.....	15
Center Width, Sound Program menu.....	113
Changing speaker impedance.....	21
CINEMA DSP 3D mode.....	56
CINEMA DSP 3D Mode, Option menu.....	64
CINEMA DSP indicator.....	11
CINEMA DSP parameters.....	110
CLEAR.....	141
Clear All Preset.....	69, 73, 79
Clear Preset.....	69, 73, 79
Close, DOCK (iPod).....	95
COAXIAL jack.....	29
COMPONENT VIDEO jack.....	29
Compressed Music Enhancer.....	57
Configuration, Manual Setup, Speaker setup.....	116
Connect, Option menu.....	65
Connecting speakers.....	20
Connecting to network.....	40
Connecting USB storage device.....	41
Connections.....	15
Content window.....	66
Control Select, HDMI setup.....	123
Controlling Zone2, Zone3 or Zone4.....	154
Cursor indicators.....	11

D

Decode Type, Sound Program menu.....	112, 113
Decoder Mode, Input menu.....	104
Dialogue Lift, Option menu.....	64
Digital Out Assign, Multi Zone setup.....	126
Dimension, Sound Program menu.....	113
Direct number access mode.....	76
Direct, Sound Program menu.....	112

Disconnect, Option menu.....	65
Display Set, Function setup.....	130
Distance, Speaker setup.....	118
DMC Control, Input menu.....	104
DSP Level, Sound Program menu.....	110
DVD player connection.....	33
Dynamic Range, Sound setup.....	120

E

Enhancer, Input menu.....	104
ERASE.....	142
Extended Surround, Option menu.....	64
External component connection.....	29
External decoder connection.....	38

F

Features of Web Control Center.....	100
Features of Zone OSD.....	153
FIRM UPDATE, Advanced Setup menu.....	147
FM antenna connection.....	42
FM tuning.....	67
Front panel.....	8
Front panel display.....	11
Front Presence L Level, Sound Program menu.....	112
Front Presence R Level, Sound Program menu.....	113
Front speaker.....	15
Function setup.....	128

G

Game connection.....	38
----------------------	----

H

HD Radio™ reception.....	70
HDMI Control function.....	148
HDMI Control, HDMI setup.....	123
HDMI indicator.....	11
HDMI jack.....	29
HDMI Monitor, Information menu.....	132



HDMI setup	123	Menu browse control.....	95	Presence speaker.....	15
High-frequency sound adjustment	53	MONITOR CHECK, Advanced Setup menu	146	Presence speaker connection	20
I					
Information menu.....	132	Monitor Out Assign, Multi Zone setup.....	127	Presence speaker layout.....	17
Initial Delay, Sound Program menu.....	110	Multi information display	11	PRESET.....	136
Initial Volume, Sound setup	120	Multi Zone setup	126	Preset Select	73
INITIALIZE, Advanced Setup menu	147	Multi-format player connection	38	Preset Select, TUNER	69
Input Assignment, Function setup	129	Multi-zone function.....	152	Pure Direct Mode	57
Input menu	102	MUTE indicator	11	Pure Direct Mode, Sound setup.....	120
Input menu list	103	N			
Internet Radio.....	84	Network connection	40	Radio Control	78
IP Address, Network setup	125	NETWORK port	40	Rear panel.....	10
iPhone™ playback	94	Network setup	125	Recording device connection	40
iPod Interlock, Input menu	105	Network Standby, Network setup	125	RECOV./BACKUP, Advanced Setup menu.....	146
iPod™ playback.....	94	Network, Information menu.....	133	Registering remote control codes.....	136
iTunes Tagging	71	Normal tuning	67	REMOTE CON AMP, Advanced Setup menu	145
J					
Jack	29	Now Playing view	66	Remote control	12
L					
Language.....	131	O			
LEARN	137	ON SCREEN menu.....	60	Remote control battery installation	13
Level, Speaker setup	118	On-screen display	14	Remote control connection.....	39
Lipsync, Sound setup.....	120	OPTICAL jack	29	Remote control, Controlling other components	134
Liveness, Sound Program menu	111	Option menu.....	62	REMOTE SENSOR, Advanced Setup menu	145
Load, Scene menu	107	Option menu list.....	63	Remove Account, Input menu.....	104
Low-frequency sound adjustment.....	53	P			
M					
MAC Address Filter, Network setup	125	Pairing, Option menu	65	RENAME	139
MACRO.....	140	Panorama, Sound Program menu.....	113	Rename/Icon Select, Input menu.....	103
Manual Preset.....	67	Parametric EQ, Speaker setup.....	118	Rename/Icon Select, Scene menu	108
Manual Setup, Speaker setup.....	115	Parental Lock	79	Repeat, Option menu.....	65
Manual Tuning.....	72	Party mode	155	Reset, Scene menu.....	108
Manual Tuning, TUNER	68	Party Mode Set, Multi Zone setup	127	Resetting all remote control codes	136
Max Volume, Sound setup.....	120	PC.....	80	Resolution, Processing, Video setup	121
Memory Guard, Function setup	131	PHONES jack.....	9	Reverb Delay, Sound Program menu	111
N					
		Play Control, DOCK (iPod).....	96	Reverb Level, Sound Program menu	112
		Play Control, Internet Radio	85	Reverb Time, Sound Program menu	111
		Play Control, PC.....	81, 89	Rhapsody Trial, Input menu	104
		Play Control, USB.....	83	Rhapsody®.....	86
		Power Amp Assign, Manual Setup, Speaker setup.....	116	Room Size, Sound Program menu	110
		PREOUT connection.....	28	S	
				Satellite Radio	74
				Save, Scene menu.....	107
				SCENE function.....	54



Scene menu	106	Surround speaker	15	Y	
Setting Data Copy, Manual Setup, Speaker setup	115	S-VIDEO jack	29	YPAO	43
Setting Pattern, Manual Setup, Speaker setup	115	System, Information menu	133	Z	
Setup menu	114	T		ZONE OUT connection	28
Setup menu list	115	Test Tone, Speaker setup	119	Zone Rename, Multi Zone setup	128
Shortcut function	93	Tone control	53	Zone Scene Rename, Multi Zone setup	128
Shuffle, Option menu	65	Tone Control, Option menu	64	Zone, Information menu	133
Sign In, Input menu	104	Transmitter of the Wireless System for iPod	96	Zone2 Set, Multi Zone setup	126
SILENT CINEMA mode	55	Trigger connection	39	Zone3 Set, Multi Zone setup	126
Simple remote control	96	Trigger Output, Function setup	130		
Simplified remote control	143	Tuner indicator	11		
SIRIUS Internet Radio	90	TV Audio Input, HDMI setup	124		
SIRIUS PIN, Advanced Setup menu	146	TV FORMAT, Advanced Setup menu	146		
SIRIUS Satellite Radio	74	TV monitor connection	30		
SiriusConnect™ tuner	74	U			
Sound program	55	USB port	41		
Sound program list	58	USB storage device connection	41		
Sound Program menu	109	USB storage devices	82		
Sound setup	119	Utility, TUNER	69		
Speaker connection	15	V			
SPEAKER IMP., Advanced Setup menu	144	VERSION, Advanced Setup menu	147		
Speaker indicators	11	Video Adjustment, Option menu	65		
Speaker layout	16, 24	VIDEO jack	29		
Speaker setting	43	Video Out, Input menu	105		
Speaker setup	115	Video setup	121		
Standby Charge, Input menu	104	Video Signal, Information menu	132		
Standby Through, HDMI setup	124	Virtual CINEMA DSP 3D mode	56		
Straight decoding mode	56	Virtual CINEMA DSP mode	55		
Subwoofer	15	VOLUME	8		
Supplied accessories	2	VOLUME indicator	11		
Surround Back Initial Delay, Sound Program menu	110	Volume Trim, Option menu	65		
Surround Back L Level, Sound Program menu	112	W			
Surround Back Liveness, Sound Program menu	111	Web Control Center	100		
Surround Back R Level, Sound Program menu	112				
Surround Back Room Size, Sound Program menu	110				
Surround back speaker	15				
Surround Initial Delay, Sound Program menu	110				
Surround L Level, Sound Program menu	112				
Surround Liveness, Sound Program menu	111				
Surround R Level, Sound Program menu	112				
Surround Room Size, Sound Program menu	110				





The latest firmware notification / La dernière notification du pare-feu / Meldung der neuesten Firmware-Version / Meddelande om senaste firmware / L'avviso per il firmware più recente

When the following notifications are displayed in the ON SCREEN menu **while this unit is connected to the network**, the firmware of this unit can be updated by using the Advanced Setup menu. Refer to "Firmware update" in the Owner's Manual for details on how to update the firmware.

Si les notifications suivantes sont affichées dans le menu ON SCREEN **alors que cet appareil est connecté au réseau**, le pare-feu de cet appareil peut être mis à jour à l'aide du menu Advanced Setup. Reportez-vous à la section « Mise à jour du pare-feu » dans le Mode d'emploi pour plus de détails concernant la manière de mettre à jour le pare-feu.

Wenn das ON SCREEN-Menü die unten stehenden Meldungen enthält **während dieses Gerät mit dem Netzwerk verbunden ist**, kann die Firmware dieses Geräts im Advanced Setup-Menü aktualisiert werden. Wie Sie die Firmware aktualisieren, ist unter „Firmware-Update“ in der Bedienungsanleitung beschrieben.

När följande meddelande visas på ON SCREEN-menyn **medan receiveern är ansluten till nätverket**, kan firmware för receiveern uppdateras via Advanced Setup-menyn. Se "Firmware-uppdatering" i Bruksanvisningen för mer information om hur man uppdaterar firmware.

Quando compaiono i seguenti avvisi nel menu ON SCREEN e l'unità è collegata alla rete, è possibile aggiornare il firmware dell'unità tramite il menu Advanced Setup. Fare riferimento a "Aggiornamento firmware" nel Manuale di istruzioni per maggiori dettagli su come aggiornare il firmware.

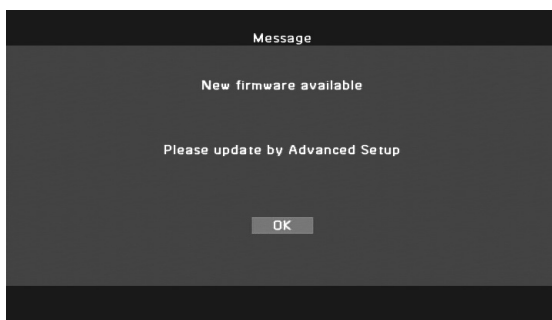

- When pressing ON SCREEN
- Lorsqu'on appuie sur ON SCREEN
- ON SCREEN gedrückt
- När ON SCREEN trycks ner
- Quando si preme ON SCREEN

↓ ENTER

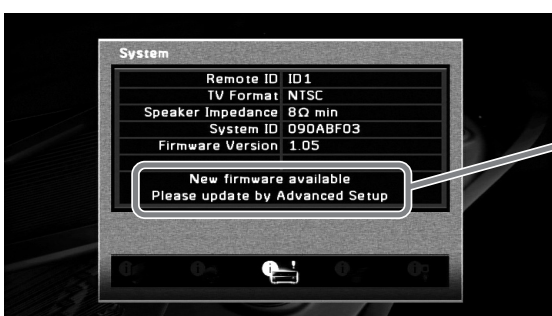
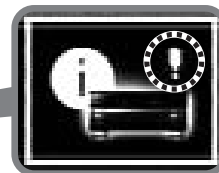
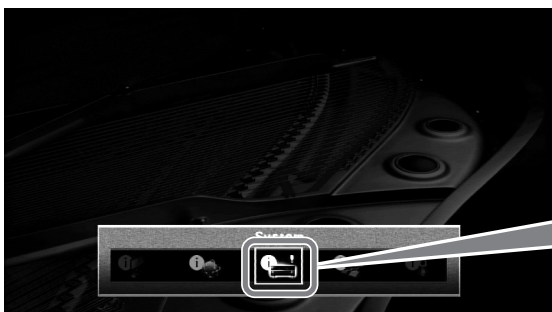

Message
 Message
 Meldung
 Meddelande
 Messaggio

Aviso sobre la última versión del firmware / De nieuwste firmware-kennisgeving / Уведомление о последнем встроенном программном обеспечении / 最新固件通知 / 최신 펌웨어 알림

Cuando los avisos siguientes aparecen en el menú ON SCREEN estando esta unidad conectada a la red, el firmware de esta unidad se puede actualizar utilizando el menú Advanced Setup. Consulte “Actualización del firmware” en el Manual de Instrucciones para conocer más detalles sobre cómo actualizar el firmware.

Wanneer de volgende kennisgevingen worden weergegeven in het ON SCREEN-menu als dit toestel is aangesloten op het netwerk, dan kan de firmware van dit toestel worden geupdate via het Advanced Setup menu. Raadpleeg “Firmware update” in de Gebruiksaanwijzing voor informatie over het updaten van de firmware.

При отображении следующих уведомлений в меню ON SCREEN, когда аппарат подсоединен к сети, встроенное программное обеспечение данного аппарата может быть обновлено с помощью меню Advanced Setup. Для получения подробной информации об обновлении встроенного программного обеспечения см. “Обновление встроенного программного обеспечения” в документе Инструкция по эксплуатации.

在本机连接至网络的情况下，如果在 ON SCREEN 菜单中显示以下通知，则可利用 Advanced Setup 菜单对本机的固件进行更新。请参见使用说明书中的“固件更新”，获取有关固件更新方法的详情。

이 장치를 네트워크에 연결할 때 ON SCREEN 메뉴에 다음의 알림 메시지가 표시되는 경우, Advanced Setup 메뉴를 사용하여 이 장치의 펌웨어를 업데이트할 수 있습니다. 펌웨어 업데이트 방법에 대한 자세한 내용은 사용 설명서에서 “펌웨어 업데이트”를 참조하십시오.

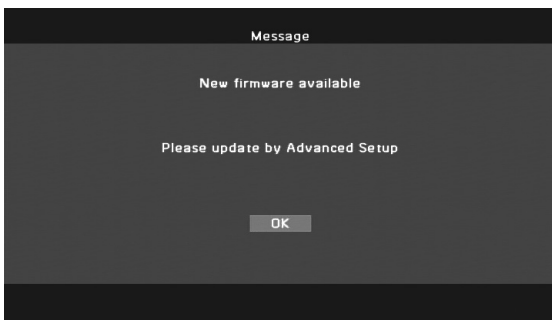

- AI pulsar ON SCREEN
- Bij drukken op ON SCREEN
- При нажатии ON SCREEN
- 按 ON SCREEN 时
- ON SCREEN 을 누를 경우

↓ ENTER

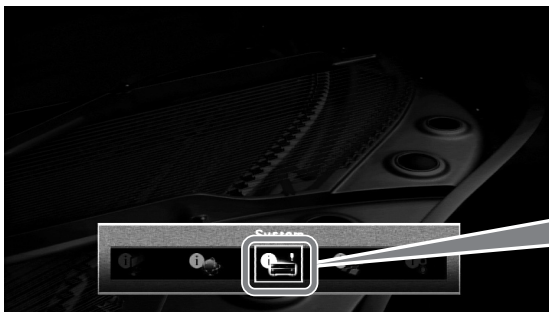
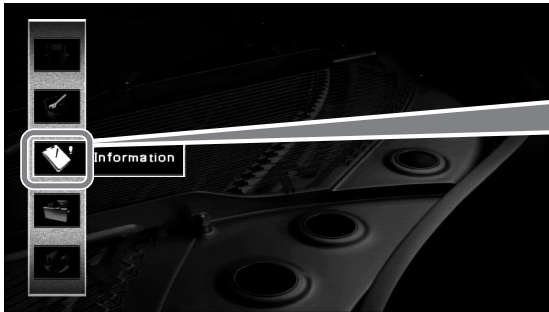

Mensaje
Bericht
Сообщение
信息
메시지

List of remote control codes
Liste des codes de commande
Liste der Fernbedienungscodes
Lista över fjärrstyrningskoder
Elenco dei codici di telecomando

Lista de códigos de mando a distancia
Lijst met afstandsbedieningscodes
Список кодов дистанционного управления
遥控器代码列表
리모콘코드목록

TV		Axion	0156	Condor	0161, 0277, 0320, 0323, 0342, 0350, 0351	Elin	0277, 0320, 0323, 0342, 0349, 0350
A.R. Systems	0320	Baird	0282	Contec	0179, 0277, 0323, 0342, 0343, 0344	Elite	0320, 0340, 0350
Acme	0342	Bang & Olufsen	0180, 0339	Contec/Cony	0012, 0058	Elman	0341
Acura	0323, 0343	Basic Line	0282, 0320, 0323, 0340, 0343, 0350	Continental Edison	0345	Elta	0277, 0323, 0343
ADC	0337	Bastide	0282, 0342	Cosmel	0323, 0343	Emerson	0000, 0007, 0008, 0012, 0013, 0019, 0026, 0031, 0037, 0051, 0058, 0059, 0161, 0179, 0320, 0339
Admiral	0054, 0178, 0336, 0337, 0339, 0346, 0347	Baur	0320, 0349	Craig	0058, 0179	Emprex	0154
Advent	0158	Bazin	0282	Crosley	0010, 0037, 0171, 0339	Envision	0008, 0026, 0050
Adventura	0057	Beko	0161, 0269, 0294, 0302, 0311, 0320, 0328, 0351	Crown	0058, 0161, 0171, 0179, 0320, 0323, 0343, 0349, 0350, 0351	Epson	0155, 0206, 0359
Adyson	0277, 0282, 0342	Belcor	0008	CS Electronics	0277, 0340, 0342	Erres	0320, 0349, 0350
Agashi	0277, 0282	Bell & Howell	0019, 0054	CTC Clatronic	0341	ESA	0051
Agazi	0337	Benq	0097, 0242, 0361	CTX	0205	ESC	0282
Aiko	0277, 0282, 0320, 0323, 0342, 0343	Beon	0320, 0349, 0350	Curtis Mathes	0007, 0008, 0010, 0019, 0021, 0026, 0049, 0050, 0178	Etron	0343
Aim	0320	Best	0161	CXC	0058, 0179	Eurofeel	0282
Aiwa	0078, 0379	Bestar	0161, 0320, 0350	Cybertron	0340	Euro-Feel	0337
Akai	0050, 0055, 0109, 0159, 0181, 0277, 0282, 0320, 0323, 0340, 0343, 0349, 0350	Binatone	0282, 0342	Cytron	0152	Euroline	0349
Akiba	0320, 0340	Blue Sky	0320, 0340	Daewoo	0007, 0008, 0026, 0037, 0053, 0167, 0266, 0275, 0277, 0282, 0315, 0320, 0323, 0331, 0335, 0342, 0343, 0350, 0381, 0465	Euroroman	0161, 0277, 0282
Akura	0320, 0323, 0337, 0340	Blue Star	0348	Dainichi	0277, 0340	Euromann	0320, 0337, 0342, 0350
Alaron	0277	Boots	0282, 0342	Dansai	0277, 0282, 0320, 0337, 0349, 0350	Expert	0321
Alba	0161, 0277, 0320, 0323, 0340, 0342, 0343, 0344, 0349, 0351, 0372, 0382	BPL	0320, 0348	Dantax	0161, 0349	Exquisit	0320
Albatron	0140	Bradford	0058, 0179	Dawa	0320	Fenner	0323, 0343
Alcyon	0171	Brandt	0322, 0345	Daytron	0007, 0008, 0026, 0323, 0343	Ferguson	0322, 0345, 0349
Alleron	0059	Brilliant	0182	De Graaf	0346	Fidelity	0277, 0320, 0342, 0346
Allorgan	0282	Brinkmann	0320	Decca	0282, 0320, 0342, 0349, 0350	Filsai	0282
Allstar	0320, 0350	Brionvega	0320, 0339, 0349, 0350	Dell	0145, 0245	Finlandia	0346
America Action	0179	Britannia	0277, 0282, 0342	Denver	0358, 0362	Finlux	0171, 0282, 0320, 0339, 0341, 0342, 0349, 0350
AMOi	0276	Brockwood	0008	Desmet	0320, 0349, 0350	FIRST LINE	0342, 0343, 0350
Amplivision	0161, 0282, 0321, 0342	Broksonic	0109, 0179	Diamant	0320	Firstline	0277, 0282, 0320, 0323
Amstrad	0320, 0323, 0337, 0340, 0343	Bruns	0339	Diamond	0277	Fisher	0019, 0161, 0282, 0339, 0342, 0344, 0351
Amtron	0058	BTC	0340	DiamondVision	0135, 0143	Flint	0320, 0350
Anam	0179, 0343	Bush	0269, 0282, 0283, 0304, 0320, 0323, 0328, 0332, 0340, 0343, 0344, 0346, 0348, 0349, 0350, 0372, 0382, 0463, 0470, 0472	Dimensia	0049	Formenti	0171, 0277, 0336, 0339, 0342, 0349
Anam National	0052, 0058	Capsonic	0337	Disney	0219	Formenti/Phoenix	0277
Anglo	0323, 0343	Carena	0320	Dixi	0282, 0320, 0323, 0343, 0349, 0350	Fortress	0366, 0339
Anitech	0171, 0320, 0323, 0337, 0343	Carnivale	0050	Dream Vision	0461, 0498	Fraba	0161, 0320
Ansonic	0161, 0168, 0320, 0323, 0341, 0343	Carrefour	0344	DTS	0323, 0343	Friac	0161
AOC	0008, 0026, 0050, 0053	Carver	0010	Dual	0282, 0320, 0342	Frontech	0282, 0323, 0337, 0343, 0346, 0347
Apex	0039, 0111, 0217	Cascade	0320, 0323, 0343	Dual-Tec	0342, 0343	Fujitsu	0059, 0069, 0074, 0075, 0282
Arcam	0277, 0282	Casio	0367	Dumont	0008, 0030, 0062, 0282, 0339, 0341, 0342	Fujitsu General	0282
Arcam Delta	0342	Cathay	0320, 0349, 0350	Durabrand	0031, 0051, 0179, 0215	Fujitsu Siemens	0504, 0505, 0507, 0510, 0511
Aristona	0320, 0349, 0350	CCE	0183, 0282	Dux	0349	Funai	0051, 0058, 0059, 0112, 0113, 0115, 0118, 0119, 0179, 0337
Arthur Martin	0321	Celebrity	0055, 0107	Dwin	0178	Futuretech	0058, 0179
ASA	0339, 0347	Celera	0039	Dynatron	0320, 0349, 0350	Galaxi	0320, 0351
Asberg	0171, 0320, 0350	Centurion	0320, 0349, 0350	Dynex	0228, 0231	Galaxis	0161, 0320
Astra	0343	Century	0339	Elbe	0161, 0168, 0282, 0320	Gateway	0176, 0177, 0241
Asuka	0277, 0282, 0337, 0340, 0342	CGE	0161, 0171	Elcit	0339	GBC	0323, 0343, 0344
Atlantic	0277, 0320, 0342, 0349, 0350	Changhong	0039	Electa	0348	GE	0008, 0021, 0023, 0026, 0027, 0031, 0034, 0049, 0052, 0056, 0209
Atori	0323, 0343	Chimeï	0273	ELECTRO TECH	0343	Geant Casino	0321
Auchan	0321	Cimline	0323, 0343	Electroband	0055, 0107	GEC	0282, 0320, 0342, 0347, 0349, 0350
Audiosonic	0161, 0282, 0320, 0340, 0342, 0343, 0349, 0350	Citizen	0007, 0008, 0026, 0050, 0058	Electrograph	0176	Geloso	0323, 0343, 0346
AudioTon	0161, 0282, 0342	City	0323, 0343	Electrohome	0008, 0026, 0052, 0055	General Technic	0323, 0343
Audiovox	0058, 0179, 0194	Clarion	0179	Element	0230		
Ausind	0171	Clarivox	0349				
Autovox	0171, 0282, 0337, 0339, 0342	Clatronic	0161, 0171, 0282, 0320, 0323, 0337, 0340, 0342, 0343, 0350, 0351				
Aventura	0051	CMS	0277				
Awa	0277, 0282	CMS Hightec	0282				
		Coby	0197				
		Colortyme	0008, 0026				
		Commercial Solutions	0021				
		Concerto	0008, 0026				
		Concorde	0323, 0343				

Genexxa	0320, 0340, 0347, 0350	Infinity	0010	Lifetec	0320, 0323, 0337, 0343	Multitech	0058, 0161, 0179, 0183, 0277, 0282, 0320, 0323, 0341, 0342, 0343, 0344, 0346, 0349
GFM	0128, 0227	InFocus	0250, 0327, 0363, 0479, 0508	Lloyds	0323		
Giant	0282	Ingelen	0347	Loewe	0161, 0168, 0265, 0320, 0330, 0352		
Gibraltar	0008, 0030, 0050, 0062	Ingersol	0323, 0343	Loewe Opta	0339, 0349, 0350	Murphy	0277, 0342
GoldHand	0277	Initial	0153	Logik	0054	NAD	0026, 0031, 0111
Goldline	0320	Inno Hit	0171, 0282, 0320, 0323, 0340, 0342, 0343, 0349, 0350	Luma	0320, 0323, 0346, 0349	Naonis	0346
GoldStar	0007, 0008, 0012, 0026, 0031, 0050, 0053, 0161, 0277, 0282, 0320, 0323, 0342, 0343, 0346, 0349, 0350	Innovation	0337, 0343	Lumatron	0282, 0320, 0346, 0349, 0350	NEC	0008, 0026, 0050, 0052, 0053, 0072, 0103, 0282, 0344
		Insignia	0131, 0228, 0236, 0238	Lux May	0350	Neckermann	0161, 0282, 0320, 0339, 0342, 0346, 0349, 0350, 0351
Goodmans	0246, 0272, 0282, 0320, 0323, 0337, 0343, 0344, 0349, 0350, 0462, 0473, 0477	Inteq	0030	Luxman	0008, 0026		
		Interactive	0161	Luxor	0282, 0342, 0346	NEI	0320, 0349, 0350
		Interbuy	0323, 0343	LXI	0010, 0019, 0021, 0026, 0027, 0031, 0049, 0111	Net-TV	0176
		Interfunk	0161, 0320, 0339, 0347, 0349, 0350	M Electronic	0342, 0343, 0345, 0347, 0349, 0350	Neufunk	0320, 0323
		International	0277			New Tech	0343, 0350
		Intervision	0161, 0282, 0320, 0337, 0341, 0342	MAG	0096	New World	0340
Gorenje	0161, 0351	Irradio	0171, 0320, 0323, 0340, 0343, 0349, 0350	Magnadyne	0339, 0341, 0349	NewTech	0282, 0320, 0323
GPM	0340			Magnafon	0171, 0277, 0341, 0342	Nicamagic	0277, 0342
GPX	0129					Nikkai	0277, 0282, 0320, 0323, 0337, 0340, 0342, 0349, 0350
Gradiente	0240	Isukai	0320, 0340	Magnavox	0008, 0009, 0010, 0013, 0026, 0032, 0033, 0048, 0050, 0128, 0211, 0212, 0224, 0226, 0239	Nikko	0277, 0342
Graetz	0347	ITC	0282, 0342			Nobliko	0171, 0277, 0341, 0342
Granada	0171, 0282, 0320, 0321, 0342, 0344, 0346, 0349, 0350	ITS	0277, 0320, 0340, 0348, 0350			Nokia	0347
Grandin	0340, 0343, 0348, 0349	ITT	0343, 0347	Magnum	0337, 0343	Norcent	0201
Gronic	0282	ITV	0320, 0343, 0349	Majestic	0054	Nordic	0282
Grundig	0160, 0161, 0171, 0310, 0320	Janeil	0057	Mandor	0337	Nordmende	0339, 0345, 0347, 0350
Grunpy	0058, 0059, 0179	JBL	0010	Manesth	0282, 0320, 0337, 0342, 0349, 0350	Nordvision	0349
Haier	0157, 0233	JC Penney	0007, 0008, 0026, 0027, 0049, 0053, 0056	Marantz	0008, 0010, 0026, 0050, 0204, 0320, 0349, 0350	Novatron	0320
Halifax	0277, 0282, 0337, 0342	JCB	0055, 0107			Oceanic	0321, 0347
Hallmark	0008, 0026, 0031	Jensen	0008, 0026	Marelli	0339	Okano	0161, 0320, 0351
Hampton	0277, 0282, 0342	JVC	0012, 0014, 0015, 0056, 0064, 0065, 0067, 0169, 0174, 0297, 0314, 0344, 0350, 0375	Mark	0277, 0282, 0320, 0323, 0349, 0350	Olevia	0102, 0199, 0200, 0207, 0222
Hanseatic	0161, 0168, 0282, 0320, 0323, 0342, 0343, 0344, 0349, 0350			Masuda	0282	ONCEAS	0342
		Kaisui	0277, 0282, 0320, 0323, 0340, 0342, 0343, 0348	Matsui	0282, 0320, 0323, 0342, 0343, 0344, 0346, 0349, 0350, 0455	Onwa	0058, 0179
Hantarex	0320, 0323, 0343			Matsushita	0017	Opera	0320
Hantor	0320	Kamosonic	0342	Maxent	0147, 0176	Oppo	0130
Harman/Kardon	0010	Kamp	0277, 0342	Mediator	0320, 0349, 0350	Optimus	0017, 0019
Harvard	0058, 0179	Kapsch	0347	Medion	0320, 0337, 0343	Optoma	0144
Harwood	0320, 0323	Karcher	0161, 0320, 0342, 0343, 0349	Megapower	0140	Optonica	0178
Havermy	0178			Megatron	0026, 0031	Orbit	0320, 0350
HCM	0282, 0320, 0323, 0337, 0342, 0343, 0348	Kawasho	0008, 0026, 0055, 0277	MElectronic	0277, 0282, 0320, 0323	Orion	0043, 0146, 0283, 0320, 0323, 0328, 0343, 0349, 0350
Hema	0282, 0323	KEC	0179			Orline	0320
Hewlett Packard	0192	Kendo	0161, 0320, 0341, 0346	Melvox	0321	Osaki	0282, 0320, 0337, 0340, 0342
Higashi	0277			Memorex	0019, 0026, 0031, 0053, 0054, 0137, 0215, 0323, 0343	Oso	0340
HiLine	0320	Kenwood	0008, 0026, 0050			Otto Versand	0282, 0320, 0336, 0342, 0344, 0348, 0349, 0350
Hinari	0320, 0323, 0340, 0343, 0344, 0349, 0350	KIC	0282	Memphis	0323, 0343	Pael	0277, 0342
		Kingsley	0277, 0342	Mercury	0320, 0323	Palladium	0161, 0282, 0320, 0342, 0351
		KLH	0039	Metz	0339		
Hisawa	0321, 0340, 0348	Kloss Novabeam	0057, 0058	MGA	0008, 0026, 0031, 0050, 0053	Palsonic	0282
Hisense	0247	Kneissel	0161, 0168, 0320			Panama	0277, 0282, 0320, 0323, 0337, 0342, 0343
Hitachi	0008, 0012, 0026, 0066, 0084, 0092, 0093, 0120, 0172, 0173, 0255, 0270, 0271, 0282, 0320, 0335, 0338, 0342, 0344, 0346, 0347, 0365, 0382, 0448, 0456, 0467	Kolster	0320, 0350	Micromaxx	0337, 0343	Panasonic	0016, 0017, 0020, 0022, 0023, 0035, 0052, 0056, 0084, 0085, 0133, 0163, 0193, 0284, 0286, 0290, 0292, 0320, 0325, 0347, 0356
		Korpel	0320, 0349, 0350	Microstar	0337, 0343		
		Korting	0161, 0339	Midland	0007, 0021, 0023, 0027, 0030, 0056, 0062	Panavision	0320
		Kosmos	0320			Pathe Cinema	0161, 0168, 0277, 0321, 0342
		Koyoda	0343	Minerva	0171	Pausa	0323, 0343
		KTV	0007, 0050, 0058, 0179, 0183, 0282, 0342	Minoka	0320, 0350	Penney	0021, 0023, 0031, 0050, 0111
Hornymphon	0320, 0350			Mintek	0153	Perdio	0277, 0320
Hoshai	0340	Kyoto	0277, 0282	Mitsubishi	0008, 0026, 0031, 0053, 0066, 0084, 0093, 0098, 0150, 0178, 0289, 0320, 0339, 0344, 0350, 0376	Perfekt	0320
Hoshai	0340	Lasat	0161			Philco	0008, 0009, 0010, 0012, 0026, 0050, 0052, 0053, 0161, 0171, 0320, 0339
Huanyu	0277, 0342	Lenco	0323, 0343	Mivar	0161, 0168, 0171, 0277, 0282, 0342	Philharmonic	0282, 0342
Hygashi	0277, 0282, 0342	Lenoir	0323, 0342, 0343	Monivision	0140	Philips	0008, 0009, 0010, 0011, 0012, 0032, 0048, 0049, 0052, 0122, 0128, 0134, 0186, 0187, 0213, 0221, 0224, 0226,
Hyper	0277, 0282, 0323, 0342, 0343	Leyco	0320, 0337, 0349, 0350	Montgomery Ward	0054		
Hypson	0282, 0320, 0321, 0337, 0342, 0348, 0349, 0350	LG	0031, 0053, 0066, 0116, 0117, 0140, 0161, 0164, 0175, 0195, 0269, 0277, 0282, 0300, 0309, 0317, 0320, 0323, 0328, 0342, 0343, 0346, 0349, 0350, 0366, 0368, 0377, 0466, 0471, 0478				
Hyundai	0141						
Iberia	0320						
ICE	0277, 0282, 0320, 0323, 0337, 0340, 0342, 0343, 0350	LG/GoldStar	0164	Motion	0171		
		Liesenk	0349	Motorola	0052, 0178		
ICeS	0277	Liesenkotter	0320	MTC	0008, 0026, 0050, 0053, 0161, 0277		
Ilo	0148, 0153	Life	0337, 0343	Multi System	0349		
IMA	0058						
Imperial	0161, 0171, 0320, 0347, 0350, 0351						
Indiana	0320, 0349, 0350						

	0239, 0256, 0257, 0259, 0261, 0263, 0267, 0280, 0281, 0287, 0296, 0299, 0301, 0303, 0305, 0313, 0319, 0320, 0324, 0333, 0339, 0342, 0349, 0350, 0353, 0357, 0360, 0380, 0383, 0452, 0459, 0460		0339		0282, 0320, 0323, 0337, 0342, 0343, 0349, 0350		0350
		Robotron	0339	Sonoko	0282, 0320, 0323, 0337, 0342, 0343, 0349, 0350	Tesmet	0337, 0343
		Rowa	0277, 0282	Sonolor	0321, 0347	Texet	0277, 0282, 0323, 0342
		Royal Lux	0161	Sontec	0161, 0320, 0349, 0350	Thomson	0162, 0188, 0189, 0285, 0320, 0322, 0342, 0345, 0350
		RTF	0339	Sony	0038, 0044, 0045, 0047, 0055, 0104, 0105, 0107, 0110, 0123, 0184, 0220, 0248, 0249, 0251, 0252, 0254, 0326, 0343, 0344, 0371, 0374, 0457, 0475	Thorn	0320, 0349
		Runco	0030, 0050, 0062	Sound & Vision	0340, 0341	TMK	0008, 0026, 0031
		Saba	0298, 0322, 0339, 0345, 0347	Soundesign	0008, 0026, 0031, 0058, 0059, 0179	TNCi	0030
		Saisho	0282, 0323, 0337, 0342, 0343	Soundwave	0320, 0349, 0350	Tokai	0282, 0320, 0350
		Salora	0346, 0347	Squareview	0051	Tokyo	0277, 0342
		Sambers	0171, 0341	SSS	0008, 0058, 0179	Tomashi	0348
		Sampo	0007, 0008, 0026, 0050, 0176	Standard	0282, 0320, 0323, 0340, 0342, 0343, 0350	Toshiba	0018, 0019, 0040, 0041, 0046, 0073, 0100, 0103, 0108, 0109, 0111, 0121, 0132, 0166, 0208, 0210, 0214, 0217, 0260, 0268, 0282, 0283, 0293, 0304, 0306, 0307, 0329, 0344, 0355, 0454
Philips Magnavox	0011, 0032, 0033	Samsung	0004, 0005, 0006, 0007, 0008, 0012, 0026, 0031, 0036, 0050, 0053, 0076, 0077, 0079, 0114, 0124, 0125, 0126, 0127, 0139, 0161, 0183, 0185, 0190, 0191, 0258, 0264, 0277, 0282, 0320, 0323, 0334, 0337, 0342, 0343, 0349, 0350, 0351, 0373, 0453, 0468	Starlite	0058, 0179, 0320, 0323, 0349	Totevision	0007
Phoenix	0161, 0277, 0320, 0339, 0349, 0350	Sansui	0043, 0109, 0320, 0350	Stern	0348	Towada	0282, 0347
Phonola	0007, 0008, 0050	Sanyo	0008, 0019, 0068, 0070, 0071, 0099, 0161, 0168, 0223, 0237, 0277, 0282, 0288, 0295, 0323, 0342, 0344, 0369, 0469	Strato	0320, 0323	Trakton	0282
Pilot	0008, 0026, 0094, 0095, 0161, 0320, 0345, 0347, 0349, 0350, 0458	Sandra	0277, 0282, 0342	Stylandia	0282	Trans Continen	0282, 0320
Pioneer	0007, 0008, 0050	Sansui	0043, 0109, 0320, 0350	Sunkai	0343	Transtec	0277
Plantron	0320, 0323, 0337, 0350	Sanyo	0008, 0019, 0068, 0070, 0071, 0099, 0161, 0168, 0223, 0237, 0277, 0282, 0288, 0295, 0323, 0342, 0344, 0369, 0469	Sunstar	0320, 0323	Trident	0282
Playsonic	0282	SBR	0320, 0349	Sunwood	0320, 0323, 0343, 0350	Triumph	0320
Polaroid	0039, 0142, 0202, 0234	Sceptre	0235, 0244	Superla	0277, 0282, 0342	Uher	0161, 0171, 0320, 0347, 0350
Poppy	0323, 0343	Schaub Lorenz	0347	Superscan	0013, 0178	Ultravox	0277, 0320, 0339, 0341, 0342
Portland	0007, 0008, 0026, 0053	Schneider	0282, 0316, 0318, 0320, 0333, 0340, 0342, 0349, 0350, 0382	SuperTech	0277, 0320, 0323	Unic Line	0320
Prandoni-Prince	0171, 0346	Scott	0008, 0012, 0026, 0031, 0058, 0059, 0149, 0179	Supra	0323, 0343	United	0349
Precision	0282, 0342	Seals	0008, 0010, 0019, 0021, 0026, 0027, 0031, 0049, 0051, 0059, 0111	Supre-Macy	0057	Universum	0161, 0171, 0282, 0320, 0337, 0349, 0350, 0351
Prima	0157, 0243, 0323, 0343, 0347	SEG	0277, 0282, 0320, 0323, 0337, 0341, 0342, 0344, 0349, 0382	Supreme	0055, 0107	Univox	0320
Princeton	0140	SEI	0320	Susumu	0340	Vector Research	0050
Prism	0023, 0056	SEI-Sinudyne	0339, 0341, 0347	Sutron	0323, 0343	Vestel	0282, 0320, 0346, 0347, 0349, 0350, 0351
Profex	0323, 0343	Seleco	0344, 0346, 0347	SVA	0151	Vexa	0320, 0323, 0343, 0349
Profi-Tronic	0320, 0350	Sencora	0323, 0343	Sydney	0277, 0282, 0342	Victor	0015, 0344, 0350
Proline	0320, 0350	Sentra	0323	Sylvania	0008, 0009, 0010, 0011, 0013, 0026, 0048, 0050, 0051, 0128, 0227, 0253	VIDEOLOGIC	0277
Proscan	0021, 0027, 0049	Serino	0277	Symphonic	0051, 0058, 0062, 0128, 0179, 0215	Videologique	0277, 0282, 0340, 0342
Prosonic	0161, 0277, 0282, 0320, 0342, 0349	Sharp	0000, 0001, 0002, 0003, 0007, 0008, 0012, 0026, 0060, 0088, 0089, 0091, 0138, 0165, 0170, 0178, 0198, 0229, 0262, 0278, 0279, 0291, 0308, 0312, 0336, 0344, 0354, 0370, 0449, 0450, 0451, 0464, 0474, 0476	Syntax	0199	VideoSystem	0320, 0350
Protech	0282, 0337, 0341, 0342, 0343, 0349, 0350	Sheng Chia	0178	Syntax-Brilliant	0199	Videotechnic	0277, 0282
Proton	0008, 0012, 0026, 0031	Shogun	0008	Sysline	0349	Vidikron	0010
Protron	0196	Siarem	0320, 0339, 0341	Sytong	0277	Vidtech	0008, 0026, 0031, 0053
PROVIEW	0096, 0246	Sierra	0320, 0350	Tandy	0178, 0282, 0336, 0340, 0342, 0347	Viewsonic	0176, 0203, 0232, 0364
Provision	0320, 0349	Siesta	0161	Tashiko	0277, 0282, 0342, 0344, 0346	Viking	0057
Pulsar	0008, 0030, 0062	Signature	0054	Tatung	0052, 0177, 0282, 0320, 0342, 0349, 0350	Viore	0148
Pye	0256, 0320, 0349, 0350, 0378	Silva	0277	TCM	0337, 0343	Visiola	0277, 0342
Pymi	0323, 0343	Silver	0344	Teac	0282, 0320	Vision	0282, 0320, 0350
Quandra Vision	0321	Singer	0321, 0339, 0341	Tec	0282, 0323, 0342, 0343	Vizio	0008, 0177, 0218, 0242, 0500, 0501, 0502, 0503, 0506
Quasar	0017, 0023, 0052, 0056	Sinudyne	0320, 0339, 0341, 0349	Technics	0017, 0023, 0056	Vortec	0320, 0349, 0350
Quelle	0282, 0320, 0337, 0342, 0349, 0350	Skantic	0347	TechniSat	0274, 0496, 0497, 0499	Voxson	0171, 0320, 0339, 0346, 0347, 0350
Questa	0344	Solavox	0347	Techwood	0008, 0023, 0026, 0056	Waltham	0282, 0320, 0342
Radialva	0320	Sonitron	0161, 0282	TEDELEX	0282	Wards	0008, 0009, 0010, 0026, 0031, 0048, 0049, 0050, 0053, 0054, 0059
RadioShack	0019, 0021, 0031, 0050, 0179, 0320			Teknika	0007, 0008, 0010, 0012, 0026, 0053, 0054, 0058, 0059, 0179	Watson	0320, 0349, 0350
RadioShack/Realistic	0007, 0008, 0012, 0026, 0049, 0058			Teleavia	0345	Watt Radio	0277, 0341, 0342
Radiola	0282, 0320, 0349, 0350			Telecor	0282, 0320	Waycon	0111
Radiomarelli	0320, 0339			Telefunken	0320, 0322, 0345, 0350	Wega	0320, 0339, 0344
Radiotone	0161, 0320, 0323, 0350			Telegazi	0320	Wegavox	0323
Rank	0344			Telemeister	0320	Weltblick	0282, 0320, 0349, 0350
RCA	0008, 0021, 0024, 0025, 0026, 0027, 0042, 0049, 0052, 0053, 0063, 0136, 0225			Telesonic	0320	Westinghouse	0107, 0216, 0220
Realistic	0019, 0031, 0050, 0179			Telestar	0320	White Westinghouse	0037, 0090, 0277, 0320, 0341, 0342, 0349
Recor	0320			Teletech	0320, 0323, 0343, 0349	Wincom	0101, 0106
Redstar	0320			Teleton	0282, 0342	Xrypton	0320
Reflex	0320			Televideon	0277		
Revox	0161, 0320, 0349, 0350			Televiso	0321		
Rex	0337, 0346, 0347			Tensai	0282, 0320, 0323, 0340, 0343, 0350		
RFT	0161, 0168, 0339						
Rhapsody	0277						
R-Line	0320, 0349, 0350						
Roadstar	0323, 0337, 0340, 0343						

Yamaha	0008, 0026, 0050, 0053, 0080, 0081, 0082, 0083, 0086, 0087	DIRECTV	1019, 1105, 1110, 1111, 1113, 1116, 1122	Interfunk	1028	Otto Versand	1028
Yamishi	0282, 0320	Dish Network	1018	Intervision	1009, 1026	Palladium	1008, 1027, 1029, 1031
Yokan	0320	Dishpro	1018	Irradio	1008, 1029, 1031	Panasonic	1000, 1022, 1044, 1055, 1068, 1072, 1085, 1090, 1091, 1120, 1121, 1214
Yoko	0161, 0277, 0282, 0320, 0323, 0337, 0340, 0342, 0343, 0349, 0350	Dual	1009, 1027, 1028	ITT	1027	Pathe Marconi	1027
Yorx	0340	Dumont	1026, 1028	ITV	1009, 1025, 1031	Perdio	1026
Zanussi	0282, 0346	Durabrand	1114	JC Penney	1064, 1065, 1068, 1070, 1071	Philco	1008, 1068
Zenith	0008, 0028, 0029, 0030, 0031, 0054, 0061, 0062	Dynatech	1069	JCL	1068	Philips	1006, 1013, 1028, 1035, 1040, 1045, 1046, 1050, 1058, 1059, 1061, 1068, 1076, 1101, 1110, 1113, 1116, 1117, 1122, 1126, 1210, 1211
<hr/>							
VCR							
ABS	1016	ESC	1009, 1025	Kaisui	1008, 1029	Philips Magnavox	1076
Adventura	1069	Etzuko	1008, 1029	Karcher	1028	Phonola	1028
Adyson	1008	Expressvu	1018	Kendo	1008, 1024, 1025, 1030	Pilot	1071
Aiwa	1024, 1026, 1027, 1069	Ferguson	1027	Kenwood	1027, 1064, 1065	Pioneer	1028, 1036
Akai	1021, 1027	Fidelity	1008, 1026	Korpel	1008, 1029	Polaroid	1088, 1099
Akiba	1008, 1029	Finlandia	1028	Kyoto	1008	Portland	1009, 1025, 1030
Akura	1008, 1027, 1029	Finlux	1026, 1027, 1028	Lenco	1025	Prinz	1026
Alba	1008, 1009, 1024, 1025, 1029, 1030	Firstline	1008, 1024, 1029, 1031	Leyco	1008, 1029	Profex	1029
Alienware	1016	Fisher	1065	LG	1010, 1026, 1031, 1047, 1054, 1056, 1071, 1103, 1221	Proline	1026
Ambassador	1030	Flint	1024	Lifetec	1024	Proscan	1019
American High	1068	Formenti/Phoenix	1028	Linksys	1016	Prosonic	1009, 1024
Amstrad	1008, 1009, 1026	Frontech	1030	Lloyd's	1069	Pulsar	1114
Anitech	1008, 1029	Fuji	1068	Loewe Opta	1028, 1031	Pye	1028, 1102
Apex	1088	Fujitsu	1026	Logik	1008, 1029	Quarter	1065
ASA	1028, 1031	Funai	1026, 1069	Lumatron	1009, 1025	Quartz	1065
Asha	1070	Galaxy	1026	Luxor	1008	Quasar	1068
Asuka	1008, 1026, 1028, 1029, 1031	Garrard	1069	LXI	1071	Quelle	1026, 1028
Audio Dynamics	1064	Gateway	1016	M Electronic	1026	Radialva	1008
Audiosonic	1009	GBC	1029, 1030	Magnavox	1020, 1068, 1114, 1126	RadioShack	1071
Audiovox	1071	GE	1068, 1070	Magnin	1071	RadioShack/Realistic	1065, 1068, 1069, 1070, 1071
Baird	1009, 1025, 1026, 1027	GEC	1028	Manesth	1008, 1029	Radiola	1028
Bang & Olufsen	1017	Geloso	1029	Marantz	1028, 1064, 1065, 1068	Radix	1071
Basic Line	1008, 1009, 1024, 1025, 1029, 1030	General	1030	Mark	1009	Randex	1071
Baur	1028	General Technic	1024	Marta	1071	RCA	1019, 1068, 1070, 1075, 1110, 1113, 1122, 1125
Beaumarck	1070	GOI	1018	Matsui	1024, 1031	Realistic	1065, 1068, 1069, 1070, 1071
Bell & Howell	1065	GoldHand	1008, 1029	Matsushita	1068	ReplayTV	1022, 1123
Bestar	1009, 1025, 1030	Goldstar	1026, 1031, 1064, 1071	Media Center PC	1016	Rex	1027
Black Panther Line	1009, 1025	Goodmans	1008, 1009, 1025, 1026, 1029, 1030, 1031	Mediator	1028	RFT	1008, 1028, 1030
Blaupunkt	1028	Gradiente	1069	Medion	1024	Ricavision	1016
Bondstec	1008, 1030	Graetz	1027	MEI	1068	Roadstar	1008, 1009, 1025, 1029, 1031
Broksonic	1100	Granada	1028	Memorex	1023, 1026, 1031, 1065, 1068, 1069, 1070, 1071, 1098, 1114	Royal	1008
Bush	1008, 1009, 1024, 1025, 1029, 1049, 1051, 1063, 1217	Grandin	1008, 1009, 1025, 1026, 1029, 1030, 1031	Memphis	1008, 1029	Runco	1114
Calix	1071	Grundig	1028, 1029	MGN Technology	1070	Saba	1027
Candle	1070, 1071	Hanseatic	1009, 1028, 1031	Micromaxx	1024	Saisho	1024, 1029
Canon	1068	Harley Davidson	1069	Microsoft	1016	Samsung	1002, 1034, 1041, 1043, 1057, 1060, 1070, 1084, 1110, 1116, 1122, 1124, 1220, 1222
Cathay	1009	Harman/Kardon	1064	Microstar	1024	Samurai	1008, 1030
Catron	1030	Harwood	1008	Migros	1026	Sanky	1114
CGE	1026, 1027	HCM	1008, 1029	Mind	1016	Sansui	1023, 1027, 1106, 1115
Cimline	1008, 1024, 1029	Headquarter	1065	Mitsubishi	1026, 1028, 1079	Sanyo	1032, 1065, 1070
CineVision	1104	Hewlett Packard	1016	Motorola	1068	Saville	1009
Citizen	1070, 1071	Hinari	1008, 1009, 1024, 1029	MTC	1070	SBR	1028
Clatronic	1008, 1030	Hisawa	1024	Multitech	1008, 1026, 1028, 1029, 1030, 1069, 1070	Schaub Lorenz	1026, 1027
Colortyme	1064	Hitachi	1011, 1026, 1027, 1028, 1046, 1062	Murphy	1026	Schneider	1008, 1009, 1024, 1025, 1026, 1028, 1029, 1030, 1031
Condor	1009, 1025, 1030	HNS	1110	NEC	1027, 1064, 1065	Sears	1065, 1068, 1071
Craig	1070, 1071	Howard Computers	1016	Neckermann	1027, 1028	SEG	1008, 1009, 1029
Crown	1008, 1009, 1025, 1029, 1030	HP	1016	NEI	1028	SEI-Sinudyne	1028
Curtis Mathes	1064, 1068, 1070	HTS	1018	Nesco	1008, 1029	Seleco	1027
Cybernex	1070	Hughes	1111, 1113, 1122	Nikkai	1008, 1009, 1030	Sentra	1008, 1030
CyberPower	1016	Hughes Network Systems	1110, 1116	Nikko	1071	Sentron	1008, 1029
Daewoo	1009, 1025, 1030, 1038, 1069, 1223	Humax	1012, 1110, 1113	Niveus Media	1016	Sharp	1003, 1033, 1077, 1107, 1127, 1219
Dansai	1008, 1009, 1029	Hush	1016	Noblex	1070	Shintom	1008, 1029
Dantax	1024	Hypson	1008, 1009, 1024, 1029	Nokia	1009, 1027	Shivaki	1031
Daytron	1009, 1025	iBUYPOWER	1016	Nordmende	1027	Shogun	1070
DBX	1064	Impego	1030	Northgate	1016	Siemens	1031
De Graaf	1028	Imperial	1026	Oceanic	1026, 1027	Silva	1031
Decca	1026, 1027, 1028	Inno Hit	1008, 1009, 1025, 1028, 1029, 1030	Okano	1008, 1009, 1024	Silver	1009
Dell	1016	Innovation	1024	Olympus	1068	Singer	1068
Denko	1008	Instant Replay	1068	Optimus	1071		
DiamondVision	1096	Interbuy	1008, 1031	Orion	1023, 1024, 1051, 1115, 1217		
DigiFusion	1014			Osaki	1008, 1026, 1029, 1031		

Sinudyne	1028	Accurian	2142	Dual	2380	LG	2002, 2033, 2038,
Solavox	1030	Advent	2155, 2251	Durabrand	2136		2057, 2129, 2133,
Sonic Blue	1022, 1123	AEG	2362	DVX	2355		2189, 2191, 2223,
Sonneclair	1008	Airis	2364	Easy Home	2359		2238, 2270, 2288,
Sonoko	1009, 1025	Aiwa	2322	Eclipse	2354		2335, 2373, 2375
Sontec	1031	Akai	2145, 2177, 2179,	E-Dem	2364	Life	2182
Sony	1001, 1016, 1048,		2248	Electrohome	2362	Lifetec	2182
	1053, 1073, 1074,	Akura	2356	Elin	2362	Limit	2355
	1080, 1081, 1082,	Alba	2064, 2165, 2186,	Elta	2341, 2361, 2362	Liquid Video	2158
	1083, 1108, 1118,		2337, 2346	Emerson	2129, 2137, 2150	Liteon	2043, 2051, 2142
	1216	Alco	2149	Enterprise	2129	Loewe	2320
Stack	1016	Alize	2361	Enzer	2380	LogicLab	2355
Stack 9	1016	Allegro	2133	Epson	2247	Magnavox	2025, 2050, 2137,
Standard	1009, 1025	Amitech	2362	ESA	2137		2150, 2159, 2224,
Stern	1009	Amphion MediaWorks	2195	Finlux	2354, 2362, 2367		2230, 2358
STS	1068			Fintec	2377	Magnex	2367
Sunkai	1024	AMW	2195, 2363	Fisher	2134	Majestic	2360
Sunstar	1026	Apex	2030, 2124, 2125,	Funai	2137	Marantz	2328
Suntronic	1026		2126, 2127, 2130,	Gateway	2051	Marquant	2362
Sunwood	1008, 1029		2131	GE	2029, 2131, 2156	Matsui	2148, 2378
Superscan	1020	Apple	2241	Gericom	2351	McIntosh	2199
Sylvania	1020, 1068, 1069,	Arrgo	2138	GFM	2226	Mecotek	2362
	1102, 1126	Asono	2364	Giec	2382	Medion	2182
Symphonic	1008, 1069, 1126	Aspire	2152, 2222	Global Solutions	2355	Memorex	2028, 2145, 2234
Systemax	1016	Astar	2240	Global Sphere	2355	MiCO	2354, 2382
Tagar Systems	1016	ATACOM	2364	Go Video	2133, 2213	Micromaxx	2182
Taisho	1024	Audiovox	2061, 2149	Goodmans	2165, 2280, 2291,	Microsoft	2156
Tandberg	1009	Avious	2367		2358, 2371, 2376,	Microstar	2182
Tandy	1065	Awa	2363		2382	Minoka	2362
Tashiko	1026, 1071	Axion	2249	GPX	2227	Minowa	2367
Tatung	1026, 1027, 1028	Bang & Olufsen	2128	Gradiente	2151	Mintek	2131, 2245
TCM	1015, 1024, 1042	Baze	2367	Graetz	2380	Mitsubishi	2003
Teac	1009, 1069	BBK	2364	Greenhill	2131	Mizuda	2358, 2359
Tec	1008, 1009, 1030	Bellagio	2363	Grundig	2349	Monyka	2380
Technics	1068	Best Buy	2359	Grunkel	2362, 2366	Mustek	2186
Teknika	1068, 1069, 1071	Blaupunkt	2131	GVG	2377	Mx Onda	2354
Teleavia	1027	Blue Parade	2157	H&B	2358	Mystral	2366
Telefunken	1027	Boghe	2382	H.her	2364	Naiko	2362
Teletex	1008, 1009	Brainwave	2362	Haaz	2354, 2355	Nesa	2131
Tenosal	1008, 1029	Brandt	2148, 2188	Haier	2254	Neufunk	2380
Tensai	1008, 1026, 1029,	Broksonic	2145, 2146	Harman/Kardon	2047, 2135	Nevir	2362
	1031	Bush	2064, 2110, 2170,	HiMAX	2359	Next Base	2143
	1024		2268, 2290, 2346,	Hitachi	2062, 2090, 2115,	Nexstech	2243
Tevion	1005, 1027		2358, 2367, 2383		2274, 2282, 2316,	NU-TEC	2383
Thomson	1027	California Audio Labs	2151		2359, 2380	Onkyo	2159, 2368
Thorn	1027			Hiteker	2130	Oopla	2051
Tivo	1108, 1110, 1111,	Cambridge Audio	2354	Home Tech Industries	2364	Oppo	2196, 2255
	1113, 1117, 1118,	CAT	2352, 2353		2366	Optim	2381
	1119, 1122	CAVS	2192	Hyundai	2245	Optimus	2180
TMK	1070	Centrum	2353	Ilo	2245	Orava	2358
Tokai	1008, 1029, 1031	CGV	2354, 2362	Initial	2131, 2245	Orbit	2363
Tonsai	1029	Changhong	2140	Innovation	2182	Orion	2073, 2110
Toshiba	1004, 1016, 1027,	Cinetec	2363	Insignia	2002, 2137, 2253	Oritron	2148, 2158
	1028, 1037, 1049,	CineVision	2133, 2237	Integra	2157	P&B	2358
	1052, 1086, 1087,	Clatronic	2358, 2367	Irradio	2053	Pacific	2355
	1097, 1109, 1112,	Coby	2031, 2046, 2360	iSymphony	2246	Panasonic	2011, 2024, 2034,
	1194	Conia	2383	JBL	2135		2042, 2058, 2062,
Totevision	1070, 1071	Continental Edison	2363	JVC	2020, 2096, 2097,		2066, 2067, 2093,
Touch	1016		2362		2099, 2100, 2101,		2116, 2117, 2118,
Towada	1008, 1029	Crown	2362		2102, 2103, 2106,		2119, 2120, 2121,
Towika	1008, 1029	C-Tech	2355		2107, 2160, 2257,		2122, 2123, 2151,
TVA	1030	Curtis Mathes	2139		2260, 2262, 2263,		2159, 2164, 2166,
Uher	1031	CVG	2377		2321, 2324, 2326,		2167, 2172, 2173,
UltimateTV	1019	CyberHome	2022, 2098, 2138,		2327, 2343, 2464,		2175, 2209, 2214,
Ultravox	1009		2187, 2336		2465, 2468, 2469,		2275, 2277, 2278,
Unitech	1070	Cytron	2244		2471		2281, 2282, 2283,
United Quick Star	1009, 1025	Daenyx	2363	Jwin	2198		2301, 2374, 2470
Universum	1026, 1028, 1031	Daewoo	2001, 2133, 2276,	Kansai	2360	Parasound	2197
Vector Research	1064		2298, 2330, 2362,	Kawasaki	2149	peeKTON	2364
Video Concepts	1064		2363, 2377	Kennex	2362	Philips	2008, 2012, 2025,
Videon	1024	Daewoo International	2363	Kenwood	2041, 2151, 2348		2044, 2050, 2051,
Videosonic	1070		2363	KeyPlug	2362		2053, 2060, 2072,
Viewsonic	1016	Dalton	2357	Kiuro	2362		2108, 2111, 2147,
Voodoo	1016	Dansai	2362, 2381	Kingavon	2358		2159, 2163, 2169,
Wards	1068, 1069, 1070,	Daytek	2184, 2195, 2363	Kiss	2380		2174, 2181, 2185,
	1071	Dayton	2363	KLH	2131, 2149		2230, 2261, 2266,
Weltblick	1031	DEC	2358	Koda	2358		2267, 2286, 2287,
XR-1000	1068, 1069	Decca	2362	Koss	2013, 2148, 2158		2289, 2295, 2300,
Yamaha	1064, 1065	Denon	2059, 2151, 2193,	KXD	2359		2302, 2317, 2328,
Yamashi	1008, 1029		2332	Landel	2143		2338, 2342, 2350,
Yokan	1008, 1029	Denver	2356, 2358, 2360,	Lasonic	2132		2467
Yoko	1008, 1029, 1030,		2370	Lawson	2355	Phonotrend	2367
	1031	Denzel	2380	Lecson	2381	Pioneer	2016, 2017, 2018,
Zenith	1114	Desay	2205	Lenco	2358, 2362, 2367		2019, 2035, 2092,
ZT Group	1016	Diamond	2354, 2355	Lenoxx	2136, 2153		2094, 2095, 2109,
		DiamondVision	2225, 2232				2157, 2180, 2190,
		Disney	2010, 2028				2212, 2269, 2272,
		DK Digital	2339				2299, 2304, 2305,
		Dmtech	2176				2306, 2307, 2308,

DVD

4Kus 2051

	2309, 2310, 2311, 2344, 2345, 2347, 2379	Sylvania	2012, 2137, 2150, 2178, 2230, 2239	Panasonic	2066, 2067, 2093, 2116, 2117, 2119, 2120, 2122, 2123	Filmnet Comcrypt	3111
Pointer	2362	Symphonic	2108, 2230	Philips	2108, 2111	Finlux	3097
Polaroid	2125, 2215, 2235	Synn	2355	Pioneer	2016, 2017, 2018, 2019, 2092, 2094, 2095, 2109	Focus	3126
Portland	2362	T.D.E. Systems	2366			Foxtel	3022
Powerpoint	2363	Tatung	2001, 2362	RCA	2105	France Telecom	3100, 3101
Prima	2252	TCM	2182, 2297	Samsung	2113, 2219	Freebox	3023
Proceed	2130	Teac	2149, 2333, 2355, 2383	Sharp	2088, 2091	GC Electronics	3070
Proscan	2156	Tec	2356	Sony	2084, 2085, 2087	GE	3066, 3093
Prosonic	2360, 2377	Technics	2151	Toshiba	2086	GEC	3105
Protron	2202	Technika	2362, 2367	Yamaha	2089, 2118	Gemini	3072, 3123
Provision	2358	Telefunken	2353			General Instrument	3017, 3025, 3066, 3084, 3090, 3096, 3117
Pye	2144	Tensai	2362	DVD Recorder		Goldstar	3120
Qwestar	2148	Tevion	2182, 2355, 2357	Aspire	2222	Gooding	3099
Raite	2380	Theta Digital	2157	Astar	2240	Grundig	3098, 3099
RCA	2021, 2029, 2104, 2105, 2131, 2149, 2156, 2157, 2229	Thomson	2183, 2188, 2334, 2372	Broksonic	2146	Hamlin	3073, 3078
		Tokai	2356, 2380	Go Video	2213	Hirschmann	3097
RedStar	2356, 2360, 2362	Top Sucess	2364	Hitachi	2062	Hitachi	3066
Regent	2153	Toshiba	2032, 2036, 2037, 2039, 2048, 2049, 2054, 2055, 2072, 2073, 2076, 2078, 2079, 2086, 2145, 2159, 2218, 2233, 2256, 2259, 2296, 2369	Insignia	2002	HomeChoice	3106
Reoc	2355	TRANScontinents	2363, 2367	Irradio	2053	Humax	3021, 3080, 3083
Rimax	2361	Transonic	2367	JVC	2100, 2101, 2106, 2107	ITT Nokia	3097
Rio	2133	Trio	2362	LG	2033, 2057, 2223, 2238	Jasco	3123
Roadstar	2331, 2358	Trutech	2242	Liteon	2043	Jerrold	3017, 3018, 3025, 3066, 3072, 3084, 3090, 3096, 3119, 3123
Ronin	2363	TruVision	2359	Panasonic	2011, 2034, 2058, 2062, 2116, 2117, 2119, 2120, 2121, 2123	JVC	3099
Rotel	2203	TSM	2364	Philips	2008, 2044, 2050, 2051, 2147	Kabel Deutschland	3024, 3027, 3121
Rowa	2154, 2383	Umax	2361	Pioneer	2017, 2035	Macab	3101
Rownsonic	2353	United	2367	Pye	2144	Magnavox	3079
Saba	2148, 2188	Urban Concepts	2159	Samsung	2000, 2112, 2216	Maspro	3099
Sabaki	2355	US Logic	2245	Sansui	2073	Matsui	3099
Saivod	2362	Venturer	2149	Sanyo	2217	MegaCable	3117
Sampo	2141	Viewmaster	2364	Sony	2004, 2005, 2007, 2052, 2068, 2069, 2074, 2208, 2210, 2211	Memorex	3076, 3122
Samsung	2000, 2045, 2077, 2112, 2113, 2114, 2115, 2151, 2200, 2216, 2219, 2228, 2264, 2265, 2271, 2279, 2294, 2303, 2329, 2365	Vocopro	2206	Sylvania	2239	Minerva	3099
		VocoStar	2207	Toshiba	2032, 2036, 2037, 2039, 2049, 2054, 2055, 2076	Mnet	3107
Sansui	2073, 2145, 2354, 2355, 2362	Waitec	2364	Yamaha	2056	Motorola	3025, 3026, 3084, 3088, 3090, 3095, 3117
Sanyo	2134, 2145, 2217, 2292	Welltech	2382			Movie Time	3077, 3109
ScanMagic	2186	Westinghouse	2063, 2250			Mr Zapp	3101
Schaub Lorenz	2362	Wharfedale	2354, 2355			Multichoice	3107
Schneider	2176	Woxter	2361, 2364			Multitech	3127
Scientific Labs	2355	Xbox	2156, 2183			NEC	3064
Scott	2161, 2357	Xlogic	2355, 2362			NET Brazil	3085
Seeltech	2364	XMS	2362			Nokia	3097
SEG	2162, 2355, 2363, 2380	Xoro	2382			Noos	3101
		Yamada	2051, 2361, 2363			NSC	3077
Sharp	2006, 2040, 2088, 2091, 2182, 2194, 2220, 2221, 2231, 2236, 2293, 2340	Yamaha	2056, 2064, 2065, 2080, 2081, 2082, 2083, 2089, 2118, 2151, 2323			Oak	3074
		Yamakawa	2363, 2380			Pace	3006, 3089, 3121
Shinsonic	2245	Yukai	2186			Palladium	3099
Sigmatek	2359, 2364	Zenith	2002, 2129, 2133, 2159, 2223			Panasonic	3112, 3118, 3122
Silva	2356					Paragon	3122
Singer	2354, 2355					Philips	3068, 3071, 3079, 3099, 3100, 3101, 3103
Skymaster	2325, 2355					Pioneer	3001, 3006, 3094, 3098, 3114, 3116, 3120
Skyworth	2356					Popular Mechanics	3126
Slim Art	2362					Proscan	3066, 3093
SM Electronic	2355					Pulsar	3122
Sonic Blue	2133					PVP Stereo Visual Matrix	3018
Sontech	2366					Quasar	3122
Sony	2004, 2005, 2007, 2009, 2014, 2015, 2023, 2026, 2027, 2052, 2068, 2069, 2070, 2071, 2074, 2075, 2084, 2085, 2087, 2168, 2171, 2208, 2210, 2211, 2258, 2273, 2284, 2285, 2312, 2313, 2314, 2315, 2318, 2319, 2466					RadioShack	3123, 3127
						RCA	3030, 3031, 3087, 3118
Soundmaster	2355					Realistic	3070
Soundmax	2355					Recoton	3126
Spectra	2363					Regal	3078
Spectroniq	2201					Regency	3075
Standard	2355					Rembrandt	3066
Star Cluster	2355					Runco	3122
Starmedia	2358, 2364					Sagem	3101
Sungale	2204					Samsung	3069, 3089, 3114, 3120
Sunkai	2362					SAT	3098
Superscan	2150					Scientific Atlanta	3000, 3001, 3002, 3003, 3006, 3028, 3029, 3081, 3086, 3089, 3094, 3095, 3108
Supervision	2355					Signal	3072, 3123

Signature	3066	BT	4216	Flair Mate	4217	Lifesat	4008, 4024, 4212,
Sony	3092, 3125	Bubu Sat	4217	Foxtel	4222		4217
Sprucer	3118	Bush	4006, 4045	Freecom	4001, 4049, 4218	Lifetec	4008
Standard Component		Cambridge	4218	FTEmaximal	4024, 4217	Lorenzen	4219
	3115	Canal Satellite	4213	Fuba	4001, 4008, 4014,	Lorraine	4049
Starcom	3017, 3072, 3119,	Canal+	4213		4015, 4024, 4055,	Lupus	4008, 4024
	3123	CaptiveWorks	4099		4215	Luxor	4218
Stargate	3072, 3123	Channel Master	4007, 4110	Galaxis	4005, 4008, 4009,	Lyonnaise	4052
Starquest	3072, 3123	Chaparral	4075		4024, 4048, 4050,	Macab	4052
Supercable	3090	CHEROKEE	4216		4215, 4222	Magnavox	4101, 4127
Supermax	3127	Chess	4212, 4217	GE	4066, 4093, 4111,	Manata	4031, 4216, 4217
Tele+1	3107, 3111	CityCom	4006, 4215, 4219		4197	Manhattan	4006, 4010, 4048,
Telepiu	3107	Clatronic	4013	General Instrument			4216
Thomson	3082, 3091	CNT	4010		4019, 4073	Marantz	4055
TIME WARNER	3084	Comag	4080, 4081, 4082,	GMI	4011	Mascom	4010
Tocom	3067		4083, 4086	GOI	4117	Maspro	4006, 4217
Torx	3017	Commlink	4005	Goldbox	4213	Matsui	4216
Toshiba	3122	Comtech	4050	GoldStar	4049	Max	4219
Tristar	3127	Condor	4008, 4024, 4219	Goodmans	4002, 4006, 4029	Mediabox	4213
Tudi	3102	Connexions	4014, 4024	Goodmind	4111	Mediamarkt	4011
Tusa	3072, 3123	Conrad	4024, 4215, 4218,	Grandin	4031	Mediasat	4009, 4213, 4218
TV86	3077		4219	Grothusen	4001, 4049	Medion	4008, 4024, 4217
Unika	3065, 3070	Conrad Electronic	4217, 4219	Grundig	4004, 4006, 4015,	Medison	4217
United Cable	3018, 3119	Contec	4050		4035, 4211, 4218,	Mega	4053, 4055
Universal	3065, 3070	Coolsat	4096		4222	Memorex	4127
Universum	3097, 3099	Cosat	4048	Hänsel & Gretel	4219	Metronic	4001, 4004, 4005,
V2	3127	Coship	4109	Hantor	4001, 4013		4010, 4028, 4031,
Videoway	3019	Crown	4011	Hanuri	4010		4217
View Star	3074, 3077, 3079	Daeryung	4014	Hauppauge	4044	Metz	4015
Viewmaster	3127	Daewoo	4057, 4217	Heliocom	4219	Micro electronic	4217, 4218, 4219
Vision	3127	DDC	4007	Helium	4219	Micro Technology	4217
Visiopass	3097, 3100, 3101	Delega	4007	Hinari	4007	MicroGem	4106
Vortex View	3127	Dew	4050	Hirschmann	4015, 4024, 4210,	Micromaxx	4008, 4024
Wittenberg	3098	Diamond	4051		4216, 4218, 4219	Microstar	4008
Zenith	3113, 3122, 3124	Digiality	4219	Hisawa	4013	Microtec	4217
Zentek	3126	Digital Stream	4105	Hisense	4016	Minerva	4015
Verizon Fios	3007	DIRECTV	4056, 4064, 4067,	Hitachi	4006, 4114, 4199,	Mitsubishi	4006, 4015, 4202
			4068, 4070, 4071,		4203	Mitsumi	4054
			4074, 4107, 4116,	Homecast	4084, 4085, 4087	Morgan's	4011, 4053, 4054,
			4119, 4121, 4122,	Houston	4048		4055, 4217
			4123, 4127, 4192,	HTS	4117	Motorola	4019, 4088, 4090,
			4193, 4194, 4195,	Hughes	4064, 4068, 4192,		4091
			4196, 4197, 4198,		4194, 4196, 4202	Multichoice	4222
			4199, 4200, 4201,	Hughes Network Systems		Multitec	4212
			4202, 4203, 4206,		4071	Muratto	4049
			4207, 4221	Humax	4025, 4030, 4060,	Mysat	4217
		Discoverer	4212		4097	Navex	4013
		Discovery	4216	Huth	4005, 4011, 4012,	Neuhaus	4009, 4048, 4217,
		Diseqc	4216		4013, 4048, 4050,		4218, 4219
		Dish Network	4018, 4065, 4089,		4219, 4223	Neusat	4217
			4092, 4094, 4095,	Hypson	4031	Next Level	4019
			4117	Ilo	4016	NextWave	4223
		Dishpro	4018, 4117	Imex	4031	Nikko	4011, 4217
		Distrisat	4053	Innovation	4008	Nokia	4006, 4040
		Ditristrad	4048	Insignia	4107	Nordmende	4001, 4006, 4007,
		DNT	4014, 4053, 4055	Intertronic	4011		4010, 4052
		Drake	4072	Intervision	4048, 4219	Nova	4222
		DStv	4222	ITT Nokia	4006	Novis	4013
		Dune	4024	Jerold	4019	Oceanic	4051
		Echostar	4014, 4018, 4065,	Johansson	4013	Octagon	4001, 4004, 4050
			4089, 4117, 4217	JOK	4216	Okano	4011
		Einhell	4001, 4005, 4011,	JSR	4048	Optex	4048
			4217, 4218	JVC	4029, 4065, 4089,	Optus	4213, 4222, 4223
			4216, 4217		4117	Orbitech	4001, 4212, 4213,
		Elap	4010	Kamm	4217		4218
		Elekta	4010	Kathrein	4015, 4034, 4042,	OSat	4004
		Elsat	4217		4053, 4055, 4063,	Otto Versand	4015
		Elta	4001, 4008, 4024,		4215, 4216, 4217	Pace	4006, 4015, 4035,
			4048, 4053, 4055	Kathrein Eurostar	4215		4043, 4047, 4216
		Emanon	4001	Klap	4216	Pacific	4051
		Emme Esse	4008, 4024	Konig	4219	Packsat	4216
		Engel	4217	Kosmos	4049	Palcom	4007
		Ep Sat	4006	KR	4004	Palladium	4011, 4218
		EURIEULT	4031	Kreiselmeier	4015	Palsat	4212, 4218
		Eurodec	4052	K-SAT	4217	Panasat	4222
		Europa	4053, 4218, 4219	Kyostar	4001	Panasonic	4006, 4035, 4036,
		Europhon	4219	L&S Electronic	4024		4121, 4124, 4126,
		Eurosat	4011	Lasat	4008, 4010, 4024,		4198, 4221
		Eurosky	4008, 4011, 4024,		4054, 4212, 4215,	Panda	4006, 4219
			4011, 4215, 4219	Lasonic	4108	Pansat	4125
		Eurostar	4011, 4215, 4219	Lenco	4001, 4024, 4049,	Patriot	4216
		Eutelsat	4217		4215, 4217, 4219	Paysat	4127
		Exator	4001, 4004	Leng	4013	PCT	4110
		Expressvu	4117	Lennox	4048	Philco	4101
		Fenner	4024, 4212, 4217	Lenson	4218	Philips	4006, 4033, 4053,
		Ferguson	4006, 4052, 4214	Lexus	4053		4055, 4061, 4068,
		Fidelity	4218	LG	4049, 4103, 4107		4071, 4127, 4196,
		Finlandia	4006				4201, 4202, 4203,
		Finlux	4006				4206, 4213, 4216
		FinnSat	4050, 4052				

Satellite

AB Sat	4216, 4217
AccessHD	4104
ADB	4220
AGS	4216
Akai	4053, 4055
Alba	4001, 4004, 4006,
	4007, 4062, 4217
Aldes	4005, 4007, 4010
Allsat	4048, 4053, 4055
Allsonic	4005, 4008, 4024
Alltech	4217
Alpha	4053
Alpha Digital	4104
Alphastar	4077
Amitronica	4217
Amstrad	4011, 4035, 4217,
	4218
Anglo	4217
Ankaro	4005, 4008, 4024,
	4217
Anttron	4001, 4004
Apollo	4001
Armstrong	4011, 4053
Artec	4100
Asat	4053, 4055
ASLF	4217
Astacom	4216
Astra	4009, 4011, 4054,
	4217, 4219
Astro	4004, 4008, 4010,
	4015, 4024, 4213,
	4218, 4219
AudioTon	4004, 4048
Aurora	4222
Austar	4222
Axial	4216
Axis	4008, 4009, 4024,
	4050
Best	4008, 4024
Blaupunkt	4015
Blue Sky	4217
Boca	4011, 4054, 4059,
	4217
Boston	4216
Brain Wave	4013
Broadcast	4012
Broco	4217
BSkyB	4035, 4041

Phoenix	4050	Schneider	4008, 4212, 4216	Teleka	4004, 4011, 4014, 4218, 4219	Zehnder	4008, 4010, 4024, 4209, 4215
Phonotrend	4005, 4006, 4048	Schwaiger	4051, 4212, 4219	Telemaster	4010	Zenith	4102, 4107, 4195
Pioneer	4046, 4213	SCS	4215	Telesat	4219	Zodiac	4004
Polsat	4052	Seemann	4009, 4011, 4014	Telestar	4212, 4213, 4218		
Predki	4013	SEG	4001, 4008, 4013, 4024	Televés	4006, 4218		
Premiere	4048, 4213			Telewire	4048		
Priesner	4011	Seleco	4048	Tempo	4223		
Primestar	4076	Servi Sat	4031, 4217	Tevion	4008, 4217		
Profile	4216	Siemens	4015	Thomson	4006, 4020, 4052, 4058, 4208, 4213, 4215, 4216, 4217, 4219		
Promax	4006	Silva	4049				
Prosat	4005, 4007	Skantin	4217	Thorens	4051		
Proscan	4066, 4093, 4122, 4197	Skardin	4009	Thorn	4006		
		Skinsat	4218	Tivax	4104		
Protek	4051	SKR	4217	Tivo	4196		
Proton	4016	Skymaster	4005, 4017, 4022, 4212, 4217	Tokai	4053		
Provision	4010			Tonna	4006, 4012, 4048, 4217, 4218		
Quadral	4005, 4007, 4008, 4024, 4216	Skymax	4053, 4055	Toshiba	4194, 4202, 4203		
		SkySat	4212, 4217, 4218, 4219	Triad	4049		
Quelle	4015, 4215, 4219			Triasat	4218		
Quiero	4052	Skyvision	4048	Triax	4015, 4215, 4217, 4218		
RadioShack	4019	SM Electronic	4212, 4217	Turnsat	4217		
Radiola	4053, 4055	Smart	4215, 4217	Tvonic	4214		
Radix	4014, 4037	Sony	4067, 4070, 4213	Twinner	4031, 4217		
Rainbow	4004	SR	4011, 4054	UEC	4222		
RCA	4066, 4093, 4112, 4113, 4116, 4118, 4119, 4122, 4197, 4207	Star Choice	4019	Uher	4212		
		Starland	4217	UltimateTV	4070		
Realistic	4078	Starring	4013	Uniden	4079, 4127		
Redpoint	4009	Start Trak	4001	Unisat	4011, 4050, 4053		
Redstar	4008, 4024	Strong	4001, 4004, 4008, 4024, 4049, 4222	Unitor	4013		
RFT	4005, 4053, 4055			Universum	4015, 4215, 4219		
Roadstar	4217	STS	4115	US Digital	4016		
Roch	4031	STVI	4031	Variosat	4015		
Rover	4024, 4217	Sumida	4011	Vega	4024		
Saba	4010, 4215, 4216, 4219	Sunny Sound	4024	Ventana	4053, 4055		
		Sunsat	4217	Viewsat	4098		
Sabre	4006	Sunstar	4011, 4024, 4054	Visiosat	4013, 4048, 4216, 4217		
Sagem	4023, 4052	Supermax	4223				
Sakura	4050	Tandberg	4052	Voom	4019		
Samsung	4000, 4001, 4003, 4032, 4064, 4069, 4071, 4120, 4123, 4196, 4200	Tandy	4004	Vortec	4001		
		Tantec	4006	Welltech	4212		
SAT	4007, 4218	TCM	4008	WeTeKom	4212, 4218		
Sat Cruiser	4223	Techniland	4012	Wevasat	4006		
Sat Partner	4001, 4004, 4010, 4013, 4049, 4218	TechniSat	4014, 4021, 4026, 4027, 4038, 4039, 4053, 4212, 4213, 4218	Wewa	4006		
				Winersat	4013		
Sat Team	4217	Technology	4222	Wisi	4006, 4014, 4015, 4218, 4219		
Satcom	4012, 4219	Technosat	4223				
Satec	4217	Technowelt	4219	Woorisat	4010		
Satelco	4024	Teco	4011, 4054	Worldsat	4216		
Satford	4012	Telanon	4007	Xrypton	4024		
Satmaster	4012	Telasat	4215, 4219	XSat	4217		
Satplus	4212	Telecom	4217				
		Telefunken	4001, 4017, 4216				

CD

Yamaha 5082, 5095

CD Recorder

Yamaha 5083

MD

Yamaha 5080, 5081, 5086

Tape

Yamaha 5084, 5087

Tuner

Yamaha 5066, 5071, 5085, 5088, 5090, 5092, 5094

XM

Yamaha 5091, 5093

SIRIUS

Yamaha 5064, 5067

DOCK

Yamaha 5068, 5089

NET

Yamaha 5076, 5079

LD

Yamaha 2080

Amplifier

Yamaha 5019, 5020