

# YAMAHA CDX-700U

*Natural Sound Compact Disc Player*  
*Original Music Processing LSI*  
*Hi-bit Quadruple Oversampling Digital Filter*  
*Programmable Random Access Playback System*  
*Delete Program Play*  
*10-key Direct Search*  
*Index Search*  
*Random Play*  
*Full, Single and A-B Repeat Play*  
*Auto Space Insertion*  
*Remote Control Operation*

Thank you for purchasing the YAMAHA Compact Disc Player CDX-700U.



OWNER'S MANUAL 

## CONTENTS

Safety Instructions .....	1	Direct Search .....	10
Caution .....	2	Skip Search .....	10
Caution Labels .....	2	Manual Search .....	10
Names of Parts and Functions .....	3	Index Search .....	10
Remote Control Transmitter .....	5	Random Play .....	11
Connections .....	7	Program Play .....	11
Notes on Handling Disc .....	8	Repeat Play .....	12
Disc Loading .....	9	Timer Play .....	12
Disc Play .....	9	Troubleshooting .....	13
Direct Play .....	9	Specifications .....	14

### IMPORTANT!

Please record the serial number of your unit in the space below.  
Model: **CDX-700U**  
Serial No.:  
The serial number is located on the rear of the unit.  
Retain this Owner's Manual in a safe place for future reference.

### WARNING

To prevent fire or shock hazard, do not expose this appliance to rain or moisture.

## SAFETY INSTRUCTIONS



### • Explanation of Graphical Symbols

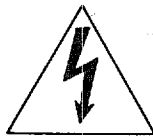

The lightning flash with arrowhead symbol, within an equilateral triangle, is intended to alert you to the presence of uninsulated "dangerous voltage" within the product's enclosure that may be of sufficient magnitude to constitute a risk of electric shock to persons.



The exclamation point within an equilateral triangle is intended to alert you to the presence of important operating and maintenance (servicing) instructions in the literature accompanying the appliance.

- 1** Read Instructions – All the safety and operating instructions should be read before the appliance is operated.
- 2** Retain Instructions – The safety and operating instructions should be retained for future reference.
- 3** Heed Warnings – All warnings on the appliance and in the operating instructions should be adhered to.
- 4** Follow Instructions – All operating and other instructions should be followed.
- 5** Water and Moisture – The appliance should not be used near water – for example, near a bathtub, washbowl, kitchen sink, laundry tub, in a wet basement, or near a swimming pool, etc.
- 6** Carts and Stands – The appliance should be used only with a cart or stand that is recommended by the manufacturer.
- 7** Wall or Ceiling Mounting – The appliance should be mounted to a wall or ceiling only as recommended by the manufacturer.
- 8** Ventilation – The appliance should be situated so that its location or position does not interfere with its proper ventilation. For example, the appliance should not be situated on a bed, sofa, rug, or similar surface, that may block the ventilation openings; or cabinet that may impede the flow of air through the ventilation openings.
- 9** Heat – The appliance should be situated away from heat sources such as radiators, stoves, or other appliances that produce heat.
- 10** Power Sources – The appliance should be connected to a power supply only of the type described in the operating instructions or as marked on the appliance.
- 11** Power-Cord Protection – Power-supply cords should be routed so that they are not likely to be walked on or pinched by items placed upon or against them, paying particular attention to cords at plugs, convenience receptacles, and the point where they exit from the appliance.
- 12** Cleaning – The appliance should be cleaned only as recommended by the manufacturer.
- 13** Nonuse Periods – The power cord of the appliance should be unplugged from the outlet when left unused for a long period of time.
- 14** Object and Liquid Entry – Care should be taken so that objects do not fall into and liquids are not spilled into the inside of the appliance.
- 15** Damage Requiring Service – The appliance should be serviced by qualified service personnel when:
  - A.** The power-supply cord or the plug has been damaged; or
  - B.** Objects have fallen, or liquid has been spilled into the appliance; or
  - C.** The appliance has been exposed to rain; or
  - D.** The appliance does not appear to operate normally or exhibits a marked change in performance; or
  - E.** The appliance has been dropped, or the cabinet damaged.
- 16** Servicing – The user should not attempt to service the appliance beyond those means described in the operating instructions. All other servicing should be referred to qualified service personnel.
- 17** Power Lines – An outdoor antenna should be located away from power lines.
- 18** Grounding or Polarization – The precautions that should be taken so that the grounding or polarization of an appliance is not defeated.

# CDX-700U

## CAUTION: READ THIS BEFORE OPERATING YOUR CDX-700U

- 1 To ensure the finest performance, please read this manual carefully. Keep it in a safe place for future reference.
- 2 Install your unit in a cool, dry, clean place – away from windows, heat sources, and too much vibration, dust, moisture or cold. Avoid sources of hum (transformers, motors). To prevent fire or electrical shock, do not expose to rain and water.
- 3 Do not operate the unit upside-down. It may overheat, possibly causing damage.
- 4 Never open the cabinet. If a foreign object drops into the set, contact your dealer.
- 5 Do not place records or other objects on top of the unit; this will block the ventilation holes, cause the internal temperature to rise and may result in a failure.
- 6 Do not use force on switches, knobs or cords. When moving the set, first turn the unit off. Then gently disconnect the power plug and the cords connecting to other equipment. Never pull the cord itself.
- 7 Do not attempt to clean the unit with chemical solvents; this might damage the finish. Use a clean, dry cloth.
- 8 Be sure to read the "Troubleshooting" section on common operating errors before concluding that your unit is faulty.

- 9 This equipment generates and uses radio frequency energy and if not installed and used properly, that is, in strict accordance with the manufacturer's instructions, may cause interference to radio and television reception. It has been type tested and found to comply with the limits for a Class B computing device in accordance with the specifications in Subpart J of Part 15 of FCC Rules, which are designed to provide reasonable protection against such interference in a residential installation.

However, there is no guarantee that interference will not occur in a particular installation. If this equipment does cause interference to radio or television reception, which can be determined by turning the equipment off and on, the user is encouraged to try to correct the interference by one or more of the following measures:

- Reorient the receiving antenna
- Relocate the CDX-700U with respect to the receiver
- Move the CDX-700U away from the receiver
- Plug the CDX-700U into a different outlet so that the CDX-700U and receiver are on different branch circuits.

If necessary, the user, should consult the dealer or an experienced radio/television technician for additional suggestions. The user may find the following booklet prepared by the Federal Communications Commission helpful: "How to Identify and Resolve Radio-TV Interference Problems". This booklet is available from the U.S. Government Printing Office, Washington, DC 20402, Stock No. 004-000-00345-4.

## CAUTION LABELS

CAUTION – USE OF CONTROLS, ADJUSTMENTS, OR PERFORMANCE OF PROCEDURES OTHER THAN THOSE SPECIFIED HEREIN, MAY RESULT IN HAZARDOUS RADIATION EXPOSURE.

THE COMPACT DISC PLAYER SHOULD NOT BE ADJUSTED OR REPAIRED BY ANYONE EXCEPT PROPERLY QUALIFIED SERVICE PERSONNEL.

DANGER—Invisible laser radiation when open and interlock failed or defeated.  
AVOID DIRECT EXPOSURE TO BEAM.

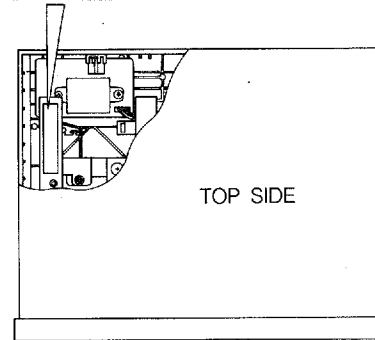

FRONT SIDE

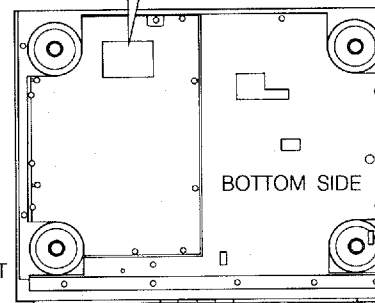
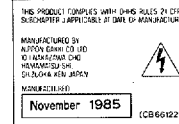

FRONT  
SIDE

# CDX-700U

## NAMES OF PARTS AND FUNCTIONS

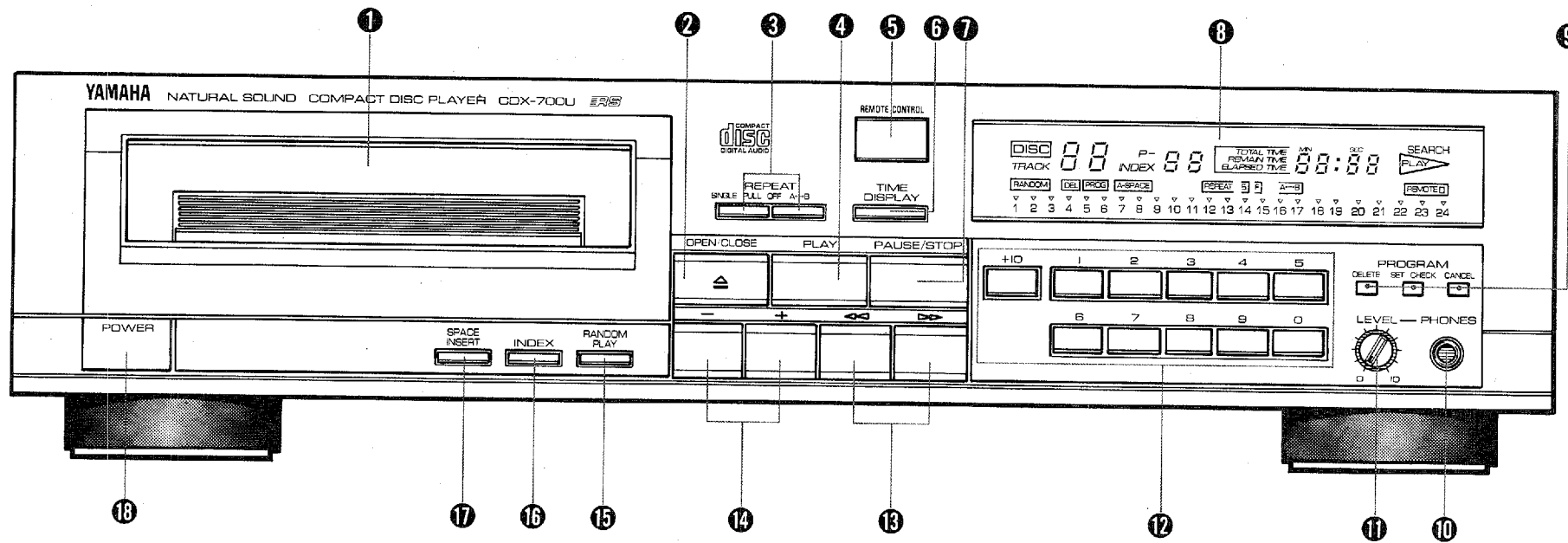

8 Display window

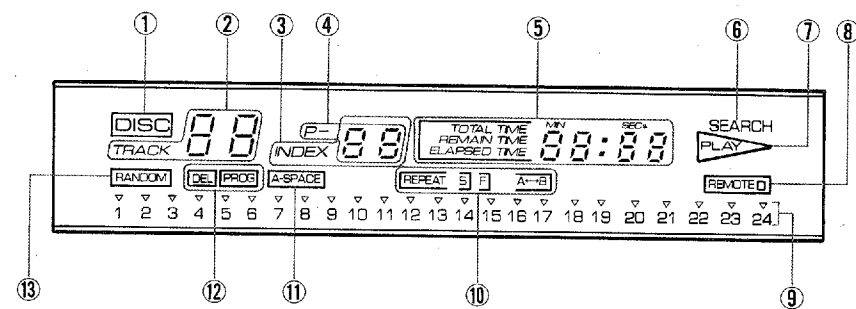

# CDX-700U



## ❶ Disc tray

Place a disc on the tray with its label surface upwards.

## ❷ OPEN/CLOSE button

Press this button to open/close the disc tray.

## ❸ REPEAT mode select buttons

Used to activate the repeat play.

**SINGLE/FULL/OFF:** Used to set and cancel the single, full or program repeat play mode, and to cancel the A-B repeat mode.

**A-B:** Used to set the A-B repeat play mode.

## ❹ PLAY button

Press to begin play. The play indicator will light.

## ❺ REMOTE CONTROL sensor

Receives the signal from the remote control transmitter.

## ❻ TIME DISPLAY button

Press this button to change the time display mode (elapsed time, total time and remain time).

## ❼ PAUSE/STOP button

When this button is pressed during play, the play indicator blinks and the disc play is temporarily stopped. Press PLAY button to resume play at the point where it was paused.

In the pause mode, pressing this button stops the unit at the beginning of the disc during normal play or at the beginning of the first programmed selection during program play.

## ❽ Display window

### ❶ DISC indicator

Lights when a disc is loaded.

### ❷ TRACK display

Shows the track number of the selection.

### ❸ INDEX display

During play, the display shows the index number of the selection being played. If the disc does not contain index number, the INDEX display remains 01.

### ❹ Program number display

Displays the program number. During programming, "P-" blinks.

When the programming is completed, this display shows the program number.

### ❺ Time display

**REMAIN TIME:** Shows the remaining play time of the disc or programmed selections.

**TOTAL TIME:** Shows the total play time of the disc or programmed selections.

**ELAPSED TIME:** Shows the elapsed time of the selection being played.

### ❻ SEARCH indicator

Lights when the unit seeks for the selection.

### ❼ Play indicator

Lights up during play.

This indicator blinks when the unit is set to pause mode.

### ❽ REMOTE indicator

The square dot on the right lights when the signal from the remote control transmitter is received.

## ❾ Music calendar display

Music triangles ( ▽ ): Indicates the tunes to be played from now including the currently playing tune.

Track No. (1 -24) : Indicates the number of tunes contained on the disc in numeric display.

### ❿ REPEAT indicators

These show the repeat play mode.

**REPEAT S :** Single repeat play

**REPEAT F :** Full repeat play

**REPEAT A-B :** A-B repeat play

### ⓫ A. SPACE indicator

This indicator lights when the Auto Space function is activated, which leaves the fixed interval between tunes.

### ⓬ Program operation indicators

**PROG (Program) :** This indicator shows that the program memory is set.

**DEL (Delete) :** This indicator shows that the delete program is set.

### ⓭ RANDOM indicator

This indicator lights when Random Play mode is engaged. Tune order on the disc is rearranged automatically so that the tunes are played at random.

## ⓮ PROGRAM operation buttons

These buttons are used when playing the required tunes in the desired order or skipping the undesired tunes.

**DELETE:** Used to set the delete program.

**SET/CHECK:** Used to set the program or check the programmed contents.

**CANCEL:** Used to clear the programmed contents.

# CDX-700U

## ⑩ PHONES jack

Connect the plug of the headphones to this jack for private listening.

## ⑪ LEVEL control

Use this control to adjust the level at PHONES jack.

## ⑫ Numeric buttons (+10, 1 - 0)

These buttons are used to designate the track number or index number for selecting the tunes or program play.

## ⑬ Forward and reverse/INDEX buttons

Press to move in forward or reverse at high speed. When the button is kept pressed for more than about 5 seconds, the forward or reverse speed is increased.

## ⑭ + and - buttons

Press to select a desired track number on the disc in the stop mode. During play, press this button to skip to the desired selection.

## ⑮ RANDOM PLAY button

When this button is pressed, the tune order on the disc is rearranged automatically and the tunes will be played at random.

## ⑯ INDEX button

When this button is pressed, the index number can be designated for index search.

## ⑰ SPACE INSERT button

Press this button to insert the interval of approx. 3 seconds between tunes when playing.

## ⑱ POWER switch

Press this switch to turn the power on. Press the switch again to turn the power off.

## REMOTE CONTROL TRANSMITTER

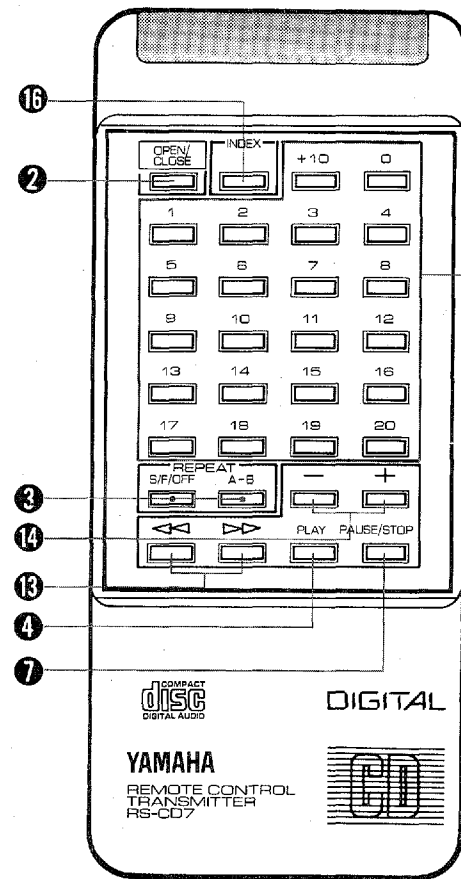

### Numeric buttons

Used to directly select the track No. to be played. (Refer to the NUMERIC BUTTONS OPERATION section on page 9.)

- Other keys on the remote control transmitter have the same functions as those on the main unit.

# CDX-700U

## BATTERY INSTALLATION

- ① Slide out the battery compartment lid in the direction of the arrow.
- ② Install the batteries (size "AA", R06) with correct polarities.
- ③ Attach the battery compartment lid until it clicks.

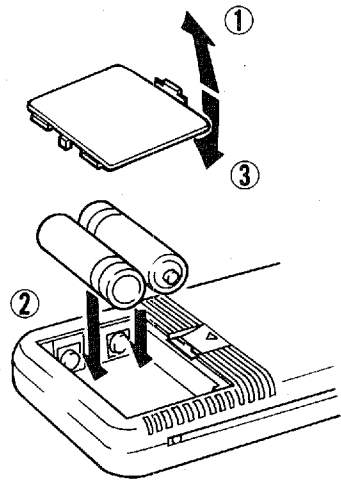

## REMOTE CONTROL OPERATION RANGE

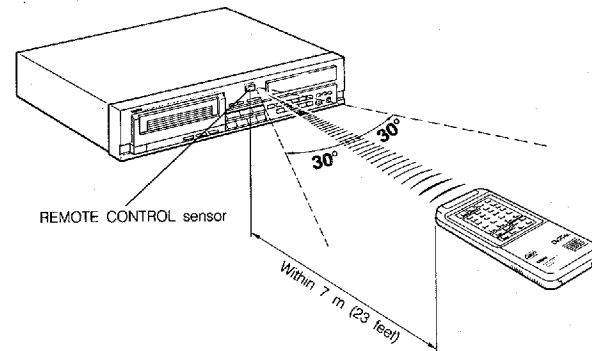

## BATTERY REPLACEMENT

When the remote controllable distance becomes short, batteries are exhausted. Replace two batteries with new ones.

### Battery cautions

Incorrect use of the battery may cause leakage or explosion. Be careful the following items:

### When replacing:

- Place the batteries in correct (+) and (-) polarities as indicated in the battery compartment.
- Do not use the old battery together with new one.
- Do not use the different kind of batteries at the same time even though in the same shape.

### Rechargeable batteries:

- There are two kinds of batteries in the market; rechargeable and non-rechargeable. Read the caution labels on the battery carefully.

### Use with the remote control transmitter:

- When not in use for an extended period of time, remove the batteries from the remote control transmitter.
- Replace the exhausted batteries earlier in good time.

### To prevent accident:

- Never disassemble, heat the battery, or throw into the fire. Dispose the batteries in the specified places.
- Do not connect (short) (+) and (-) directly with the metal piece, etc.

### In case of leakage:

Wipe off the electrolyte in the battery compartment completely before replace with the new batteries.

# CDX-700U

## CONNECTIONS

### NOTES

- Switch off the power to the components when connecting or disconnecting the pin cords.
- Do not connect to the PHONO jacks.

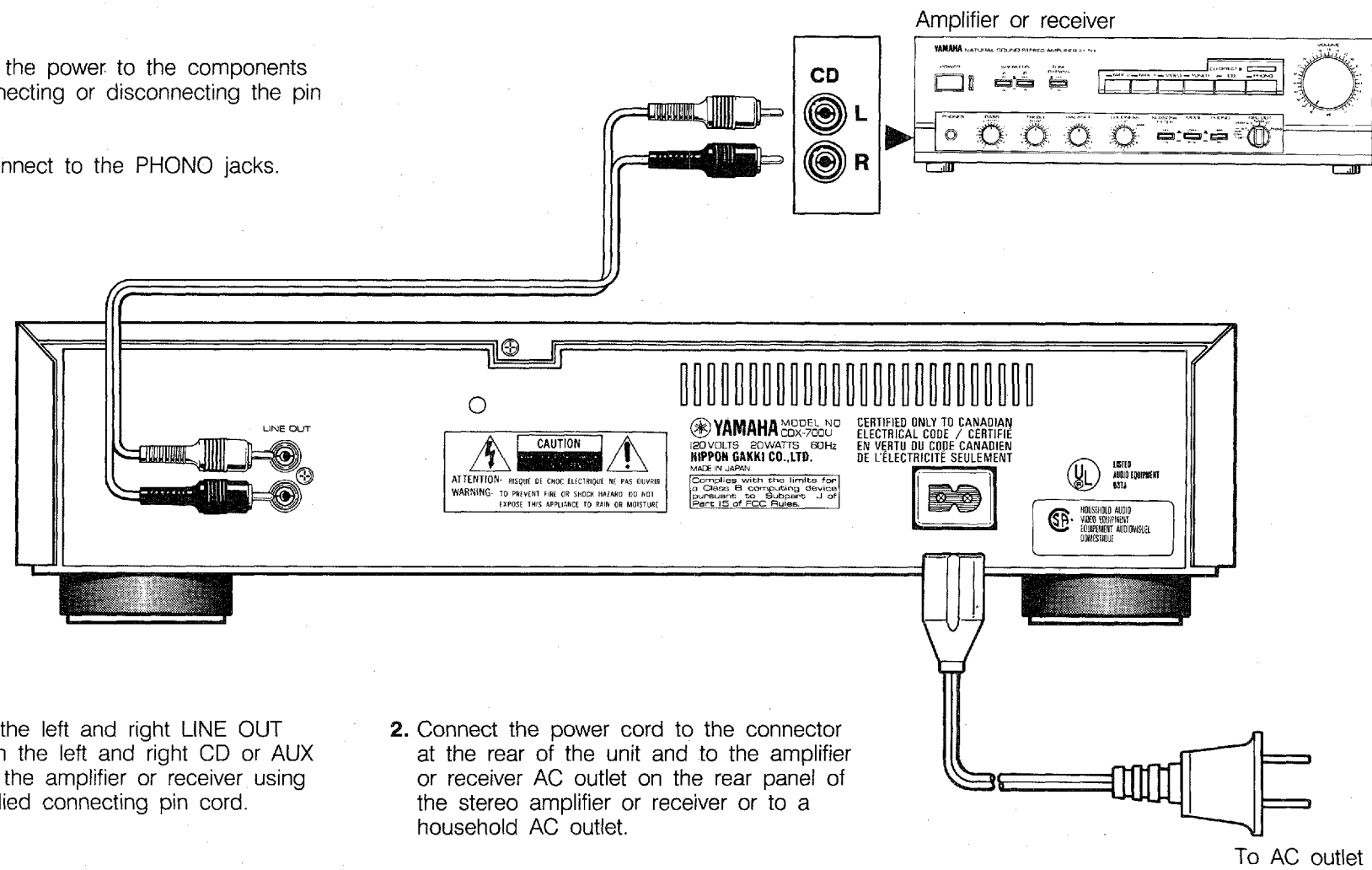

1. Connect the left and right LINE OUT jacks with the left and right CD or AUX jacks on the amplifier or receiver using the supplied connecting pin cord.

2. Connect the power cord to the connector at the rear of the unit and to the amplifier or receiver AC outlet on the rear panel of the stereo amplifier or receiver or to a household AC outlet.



# CDX-700U

## NOTES ON HANDLING DISC

- Your unit has been specifically designed for the reproduction of compact discs bearing the "CD" mark. No other discs should be loaded into the player.
- To remove the disc from its storage case, press down on the center of the opened case and lift the disc out carefully holding it by the edges.

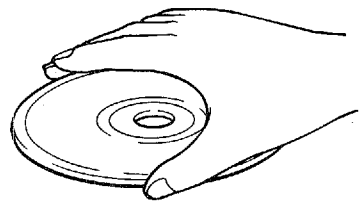
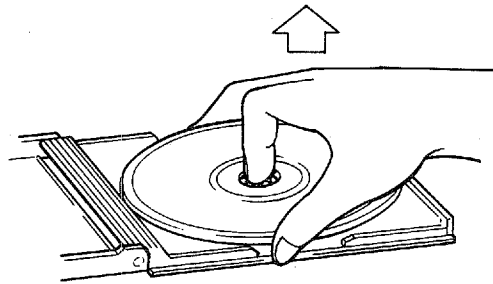

- Although compact discs are impervious to wear during play, damage to the surface of a disc through improper handling will result in play irregularities.
- Although minute dust particles and finger prints should have no effect on play, you should keep the surface of your discs clean by wiping them with a clean, dry cloth. Wipe in a straight motion from the inside to the outside.

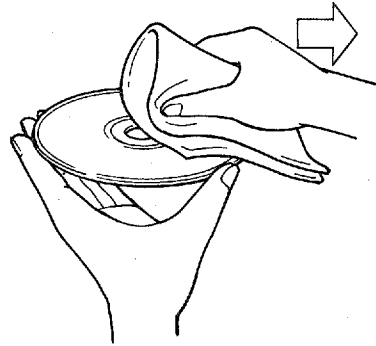

- Never use record cleaner, record spray, antistatic sprays or liquids, or any chemical-based liquid to clean the surface of disc as these may irreparably damage the disc's plastic surface. Always return a disc to its protective plastic case when not use it.

- Avoid exposing discs to direct sunlight, high temperature, or high humidity for extended periods of time. Long exposure to high temperatures may warp a disc.

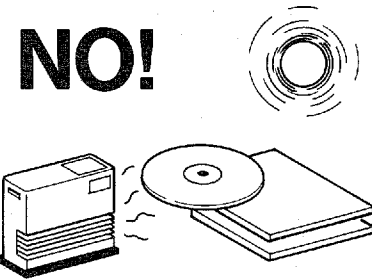

- Carefully handle the compact disc so that its surface is not scratched.

# CDX-700U

## DISC LOADING

1. Press the POWER switch.
  2. Press the OPEN/CLOSE button to open the disc tray.
  3. Place a compact disc on the disc tray with the label surface side up. Check that the disc is resting at the center of the disc tray.
  4. When the OPEN/CLOSE button is pressed, the disc tray closes.
  5. The unit operates for several seconds to read its contents, the TRACK display displays the total number of tracks, and the time display displays the total playing time for a few seconds and the unit stops at the beginning of the disc.
- \* When the PLAY button, numeric button or the front of the disc tray is pressed to close the disc tray, the total number of tracks and the total play time are not displayed and the unit will enter the play mode at the beginning of the disc.
  - Do not insert objects into the disc tray. It could result in malfunction.
  - Do not forcibly open or close the disc tray.
  - When not using the player, keep the disc tray closed.
  - Do not press down on the disc tray.

9

## DISC PLAY

1. Press the POWER switch. Press the OPEN/CLOSE button to open the disc tray and load the disc.
2. Press the PLAY button to start play. When the disc tray is closed by pressing the PLAY button or the front of the disc tray, it is not necessary to press the PLAY button.
3. Press the PAUSE/STOP button to temporarily stop disc play. To resume play press the PLAY button.
4. Press the PAUSE/STOP button twice to stop play.

### MUSIC CALENDAR DISPLAY

When a disc is loaded, the track numbers of the tunes contained on the disc (from the first tune to the last tune) are displayed, and the music triangle indicators are displayed above the track number. As the music triangle indicator will be go off when a tune is finished, the number of remaining tunes can be checked at a glance.

## DIRECT PLAY

To begin disc play directly from a desired track, press the corresponding numeric button. Play start automatically from the beginning of the selected track number.

### NUMERIC BUTTONS OPERATION

When selecting the 20th and later tunes, press the +10 button to set the 10's digit.

#### Example

To select the 25th tune:

1. Press +10 button twice.
  2. Press 5 button. Play starts automatically from the beginning of the 25th tune.
- \* Each time the +10 button is pressed, the 10's digit is increased in the order [1], [2], [3] ..... [9] and back to [0] again.
  - \* When the numeric button on the remote control transmitter is pressed after pressing the +10 button, the tune of which both numbers are added will be selected. For example, pressing "+10" and "20" will select the 30th tune.

## DIRECT SEARCH

To begin disc play from a desired track, select the desired starting track number using the + or - button in the stop mode. Press the PLAY button and the play will begin at that track.

## SKIP SEARCH

When the player is already in the play mode and you wish to move to a different desired track, select the new track number using the + or - button. The selected track number is displayed and the play will begin at that track.

- To listen to the track following that presently being played:  
Press the + button once.
- To listen to the presently playing track once again:  
Press the - button once.
- To listen to the track previous to the one presently playing:  
Press the - button twice in succession.

## MANUAL SEARCH

### FAST FORWARD MANUAL SEARCH

During play, when the forward button is pressed, play will be advanced rapidly while this button is kept pressed.

### FAST BACK MANUAL SEARCH

During play, when the reverse button is pressed, play will be fast reversed while this button is kept pressed.

- During the manual search operation, when you have found the part of the desired selection, release the forward or reverse button and normal play will begin from that point.
- If the manual search operation is begun from the pause mode, you can search for your desired location observing the time display alone without any sound.

## INDEX SEARCH

When the disc having index numbers is loaded, play can be started from the desired index number by designating with the numeric buttons.

1. Select the desired tune with numeric button.
2. Press the INDEX button. The INDEX indicator will blink.
3. Press the numeric button of the desired index point.

### Index

- Indexing means that a single track has been divided into even smaller divisions, and each division has been assigned an "index number". Before playing, consult the instructions for your particular disc.
- When the number exceeding the highest index number on the disc is designated, play will start from the last index point.
- To cancel the designated index number, press the PAUSE/STOP button.
- In the index search operation (on some discs), play may start slightly before the designated point.

# CDX-700U

- When the desired index number is detected, the index search function will be released and the blinking INDEX indicator will light.
- If no index number is encoded on the disc, play will start from the beginning of the selected tune.
- On some discs, the index search operation may require slightly longer time.
- To release the index search function, during the INDEX indicator is lit press the INDEX button.
- When the numeric button is not pressed after pressing the INDEX button, the INDEX indicator will continue blinking until the tune is finished then lights. The index number can be designated only when the INDEX indicator is blinking.

## RANDOM PLAY

1. Press the RANDOM PLAY button. The RANDOM indicator will light and the random play will start.
- During programming or program play, the random play does not function.
  - During random play, the INDEX button does not function.
  - To release the random play press RANDOM button, or numeric buttons.

## PROGRAM PLAY

1. Press the PAUSE/STOP button twice to set the player to the stop mode.
  2. Press the SET/CHECK button.  
At this time, the music triangle indicators will go off and only the track numbers of the tunes contained on the disc will be displayed.
  3. Select the desired tune to be played first with the numeric button. The corresponding music triangle indicator will light.
  4. Select the tune to be played next with the numeric button.  
In the same way as above, up to 24 tunes can be programmed in any desired order.
  5. Press the SET/CHECK button twice.
  6. Press the PLAY button to start program play.
- To check the programmed contents, press the SET/CHECK button in the stop mode. (The tune number and programmed order of the programmed tunes can be checked in turn by pressing the SET/CHECK button.)

## CHANGING AND CANCELING THE PROGRAM

### To check the program:

1. In the stop mode, press the SET/CHECK button to call up the program number to be changed.
2. Select the new tune with the numeric button. The previously programmed tune will be cleared and the new tune will be programmed in memory.

### To cancel the program:

#### To cancel the whole program:

- Press the CANCEL button in the stop mode.
- Open the disc tray.
- Turn the power off.
- After setting the program, press the SET/CHECK button to return to the first program condition (the blinking "P-" indicator lights) then press the CANCEL button.

#### To delete one tune from the program:

- In the stop mode, press the SET/CHECK button (the "P-" indicator blinks) to display the tune number to be deleted, then press the CANCEL button. The tune will be cleared and the next programmed tune will be moved up.

## NOTES

- The index number cannot be programmed.
- If the total program playback time exceeds 99 minutes 59 seconds, the rest time which is subtracted by 100 minutes from the real time will be displayed for the TOTAL TIME and REMAIN TIME display.
- In the program play, when the 24th or later tune is programmed, the REMAIN TIME and TOTAL TIME will not be displayed.

## DELETE PROGRAM PLAY

1. Press the PAUSE/STOP button twice to set the player to the stop mode.
2. Press the DELETE button then press the SET/CHECK button.
3. Set the tune number to be deleted with the numeric button.  
The corresponding music calendar indicator will go off.
4. Set the tune number to be deleted next with the numeric button.
5. Press the SET/CHECK button.
6. Press the PLAY button to start delete program play. Tunes will be played from the beginning of the disc but the designated tunes will be skipped.

- The + and - buttons and forward and reverse buttons can be used within the range of the programmed contents.
- If the forward or reverse button is kept pressed over the range of the programmed contents, the unit plays the displayed selection, then returns to the next programmed selection.

## REPEAT PLAY

### SINGLE REPEAT PLAY

Press the REPEAT SINGLE/FULL/OFF button once. The REPEAT S indicator lights and the displayed selection is played repeatedly. To release the single repeat play, press the REPEAT SINGLE/FULL/OFF button twice.

- If the forward or reverse button is kept pressed over the range of the selection to be repeated, the newly displayed selection is repeatedly played.

### FULL REPEAT PLAY

Press the REPEAT SINGLE/FULL/OFF button twice. The REPEAT F indicator lights and all the selections in the disc are played repeatedly. When the full repeat mode is set during program play, all the programmed selections are repeatedly played. To release the full repeat mode, press the REPEAT SINGLE/FULL/OFF button once.

# CDX-700U

## A-B REPEAT PLAY

By designating the desired points, any desired section can be played repeatedly.

1. During play or pause mode, press the REPEAT A-B button at the starting point for repeat play.
2. Press the REPEAT A-B button again at the stop point for repeat play. The points A and B are now registered, and the repeat play starts between A and B.

- To release A-B repeat play  
Press the REPEAT SINGLE/FULL/OFF button once to release the A-B repeat play.

\* The A-B repeat play cannot be performed during random program play.

## TIMER PLAY

Timer play can be performed when the player is used with a commercially available audio timer.

1. Set the amplifier to play the compact disc player.
2. Turn on the power and load a disc.
3. Set the timer to the time at which you wish play to begin.
4. At the time set on the timer, play will begin from the first selection of the disc. Be sure to set the output volume of the amplifier to the desired level beforehand.

# CDX-700U

## TROUBLESHOOTING

If your unit fails to operate normally, check the following points to determine whether the fault can be corrected by the simple measures suggested. If it cannot, or if the fault is not listed in the SYMPTOM column, disconnect the player's power cord and contact your dealer or service center for help.

SYMPTOM	CAUSE	REMEDY
<b>The player fails to turn on when the POWER switch is pressed.</b>	Power cord is not plugged in or not completely inserted.	Firmly plug in the power cord.
<b>The disc tray does not close completely.</b>	A foreign object is entangled in the tray.	Carefully check the disc tray and remove the foreign object.
<b>DISC indicator does not light.</b>	The disc has been inserted upside down.	Load the disc correctly.
	The disc is damaged.	Check the disc carefully and replace if necessary.
	There is moisture on the laser pickup.	Wait 20 to 30 minutes after turning the unit on before trying to play a disc.
<b>Play does not begin.</b>	Disc is loaded upside down.	Reload the disc with the label side up.
	Disc is dirty.	Clean the disc.
<b>Playback is delayed, or begins at the wrong place.</b>	The disc may be scratched or damaged.	Check the disc carefully and replace if necessary.
<b>No sound.</b>	Improper output cable connections.	Connect cables properly. If the problem persists, the cables may be defective.
	Improper amplifier operation.	Set the amplifier controls to the correct input selection.
<b>Sound "skips".</b>	Player subject to vibrations or shock.	Relocate the player.
	Disc is dirty.	Clean the disc.
<b>Sound "hums".</b>	Improper cable connections.	Firmly connect the audio plugs. If problem persists the cables may be defective.
<b>Noise in the tuner.</b>	Tuner too close to the player.	Move the tuner away from the player.
<b>Noise from within the disc tray.</b>	The disc may be eccentric.	Replace the disc.

# CDX-700U

## SPECIFICATIONS

### AUDIO SECTION

Frequency Response .....5 Hz to 20 kHz  
±0.25 dB  
Harmonic Distortion  
+Noise .....0.004% (1 kHz)  
S/N Ratio .....100 dB  
Dynamic Range .....96 dB  
Wow & Flutter .....Unmeasurable  
Output Voltage .....2 V rms  
Output Impedance .....2 k-ohms  
Headphone Output .....150 mV/8 ohms

### INTERNAL SYSTEMS

Optical Pick-up .....3-beam laser  
Error Correction System .....CIRC  
D/A Conversion .....16-bit linear  
Filter .....High bit digital  
filter and  
3rd order active  
filter

### GENERAL

Power Requirements .....120V, AC 60 Hz  
Power Consumption .....20 W  
Dimensions (WxHxD) .....435 x 107 x 347 mm  
(17-1/8" x 4-3/16"  
x 13-11/16")  
Weight .....4.6 kg (10 lbs. 2 oz.)  
Accessories .....Pin plug cord  
Power cord  
Remote control  
transmitter (RS-CD7)  
Batteries  
(size "AA", R06)

Note that all specifications are subject to  
change without notice.

SINCE 1887  **YAMAHA**  
NIPPON GAKKI CO., LTD. HAMAMATSU, JAPAN

VC39390-2 BWgV,G Printed in Japan ©