

YAMAHA CX-600/L

Natural Sound Stereo Control Amplifier

Préamplificateur stéréo de la série "Natural Sound"

CENTER

Thank you for purchasing the YAMAHA CX-600/U control amplifier.

ABOUT THIS MANUAL

To obtain the finest performance from your new control amplifier, please read this manual carefully, keeping it handy for future reference.

After you know which PRECAUTIONS to take, the section CONNECTIONS will show you how to hook up the CX-600/U to your power amplifier and other stereo components. FRONT PANEL CONTROLS AND THEIR FUNCTIONS introduces the CX-600/U's switches and knobs, while operation of this control amplifier is explained in more detail in the OPERATIONS and REMOTE CONTROL section. If you have any trouble, the final section on TROUBLESHOOTING tells you what to do before contacting your YAMAHA dealer.

CONTENTS

SAFETY INSTRUCTIONS	3
SUPPLIED ACCESSORIES	4
FRONT PANEL CONTROLS AND THEIR FUNCTIONS	5
CONNECTIONS	7
OPERATIONS	9
REMOTE CONTROL	11
TROUBLESHOOTING	14
SPECIFICATIONS	15

IMPORTANT:

Please record the serial number of your unit in the space below.

Model: CX-600/U

Serial No.:

SAFETY INSTRUCTIONS

Read this before operating your CX-600/U.

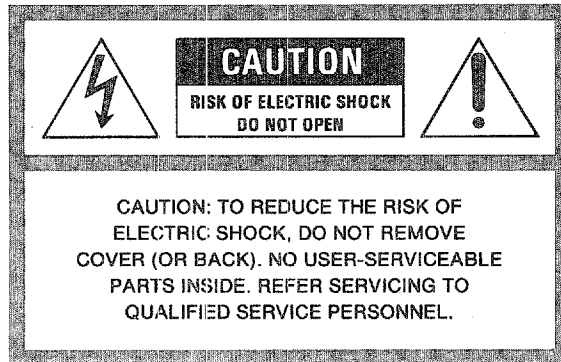

● Explanation of graphical Symbols



The lightning flash with arrowhead symbol, within an equilateral triangle is intended to alert you to the presence of uninsulated "dangerous voltage" within the product's enclosure that may be of sufficient magnitude to constitute a risk of electric shock to persons.



The exclamation point within an equilateral triangle is intended to alert you to the presence of important operating and maintenance (servicing) instructions in the literature accompanying the appliance.

WARNING:

To prevent fire and shock hazards, do not expose your amplifier to rain or moisture.

1. Read Instructions — All the safety and operating instructions should be read before the appliance is operated.

2. Retain Instructions — The safety and operating instructions should be retained for future reference.

3. Heed Warnings — All warnings on the appliance and in the operating instructions should be adhered to.

4. Follow Instructions — All operating and other instructions should be followed.

5. Water and Moisture — The appliance should not be used near water — for example, near a bathtub, washbowl, kitchen sink, laundry tub, in a wet basement, or near a swimming pool, etc.

6. Carts and Stands — The appliance should be used only with a cart or stand that is recommended by the manufacturer.

7. Wall or Ceiling Mounting — The appliance should be mounted to a wall or ceiling only as recommended by the manufacturer.

8. Ventilation — The appliance should be situated so that its location or position does not interfere with its proper ventilation. For example, the appliance should not be situated on a bed, sofa, rug, or similar surface that may block the ventilation openings; or placed in a built-in installation, such as a

bookcase or cabinet that may impede the flow of air through the ventilation openings.

9. Heat — The appliance should be situated away from heat sources such as radiators, stoves, or other appliances that produce heat.

10. Power Sources — The appliance should be connected to a power supply only of the type described in the operating instructions or as marked on the appliance.

11. Power-Cord Protection — Power supply cords should be routed so that they are not likely to be walked on or pinched by items placed upon or against them, paying particular attention to cords at plugs, convenience receptacles, and the point where they exit from the appliance.

12. Cleaning — The appliance should be cleaned only as recommended by the manufacturer.

13. Nonuse Periods — The power cord of the appliance should be unplugged from the outlet when left unused for a long period of time.

14. Object and Liquid Entry — Care should be taken so that objects do not fall into and liquids not spilled into the inside of the appliance.

15. Damage Requiring Service — The appliance should be serviced by qualified service personnel when:

- A. The power-supply cord or the plug has been damaged; or
- B. Objects have fallen, or liquid has been spilled into the appliance; or
- C. The appliance has been exposed to rain; or
- D. The appliance does not appear to operate normally or exhibits a marked change in performance; or
- E. The appliance has been dropped, or the cabinet damaged.

16. Servicing — The user should not attempt to service the appliance beyond those means described in the operating instructions. All other servicing should be referred to qualified service personnel.

17. Grounding or Polarization — The precautions that should be taken so that the grounding or polarization of an appliance is not defeated.

PRECAUTIONS

1 LOCATION

Install this unit in a cool, dry, clean place - away from windows (direct sunlight), heat sources, excessive vibration, dust, moisture or cold. Avoid sources of hum such as transformers, motors, etc.

Turn the unit off and disconnect it when moving it.

2 HANDLING

Do not use force on controls, terminals or cords. Remove plugs by gripping them directly, not by pulling the cord.

3 CLEANING

Wipe the exterior with a soft, dry cloth. Never use chemical solvents, as this might damage the finish.

4 USING A TURNTABLE

Always turn the volume all the way down (to $-\infty$) before lowering the tonearm to play a record. Only raise the volume when the stylus is in the groove.

MODEL VERSIONS

The illustrations on the right show the rear panels of the three types of CX-600/U model. Note that the Australian model has only one AC convenience outlets, while the general model is equipped with a selector for voltage conversion.

VOLTAGE SELECTOR (General Model only)

The voltage selector switch on the rear panel of the CX-600/U must be set for your local voltage BEFORE plugging in the AC mains supply. Voltages are 110/120, 220/240V AC 50/60Hz.

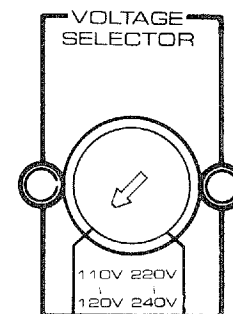

SUPPLIED ACCESSORIES

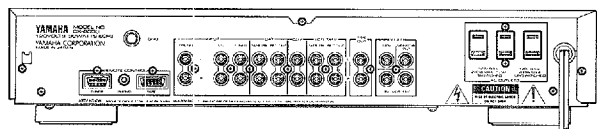

U.S. & Canadian model

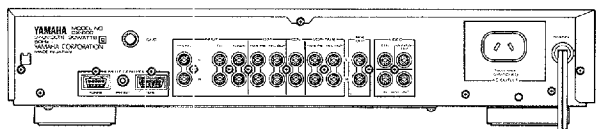

Australian model

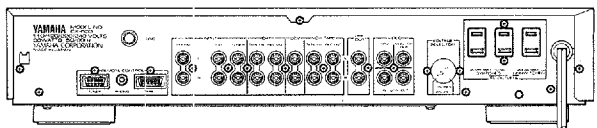

General model

After unpacking, check that the following parts are contained.

● Remote control transmitter (RS-CX600)

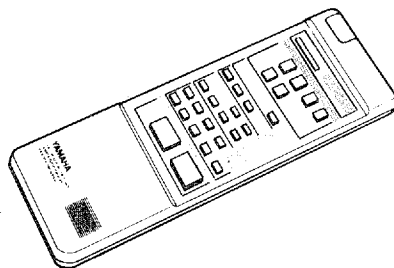

● Remote control cable (5-pin, tuner)

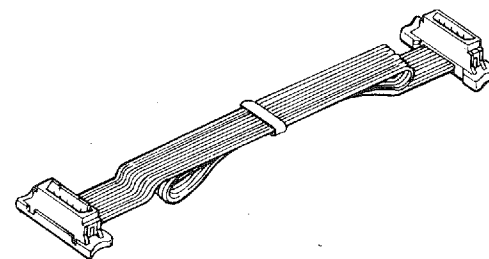

● Batteries (size "AA")

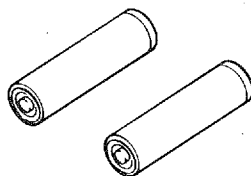

● Remote control cable (6-pin, cassette deck)

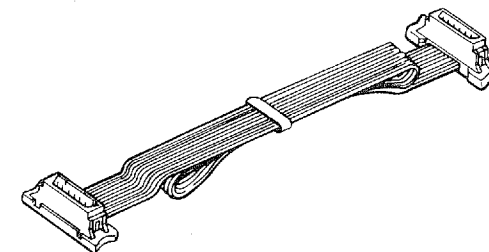

● Remote control cable (mini-plug, turntable)

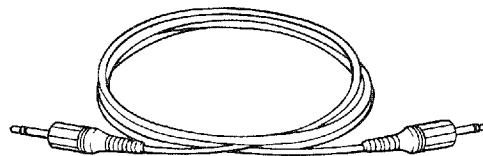

● Connecting cable (RCA plug)

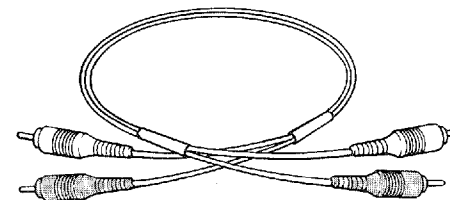

FRONT PANEL CONTROLS AND THEIR FUNCTIONS

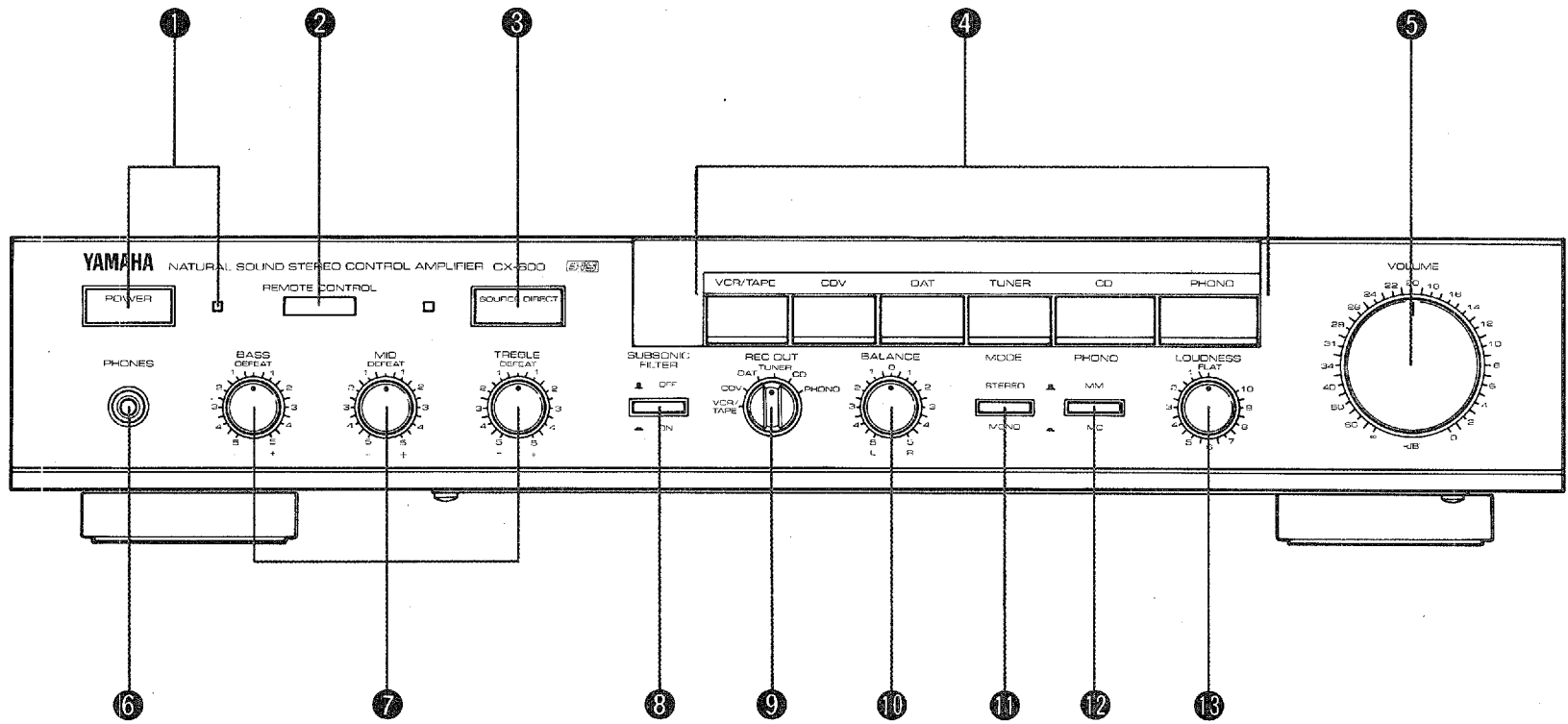

-
- ❶ **POWER switch and indicator:** Pressing this switch turns power on, causing the POWER indicator to light. To turn the unit off, press again.
 - ❷ **REMOTE CONTROL sensor:** Receives signals from the remote control transmitter. Make sure this window is not obstructed when using remote control.
 - ❸ **SOURCE DIRECT switch:** Pressing this switch routes the audio input signal directly to the CX-600/U output stage, bypassing the tone controls, subsonic filter and the mode, loudness phase invert and balance control circuits for the purest possible sound. Remember that none of the controls just mentioned will have any effect when SOURCE DIRECT is pressed.

NOTE:

If the LOUDNESS control is currently being used, pressing SOURCE DIRECT will have the effect of suddenly raising the volume.

- ❹ **Input selectors and indicators:** To select the desired source for listening or watching, press the corresponding input selector. Its indicator will light (audio sources indicated in red, video sources in green).

NOTE:

One of the green video source indicators always remains lit, even if you select an audio source. This means you can listen to the sound of the selected audio equipment while simultaneously watching the picture of the indicated video source.

- ❺ **VOLUME control:** This knob adjusts the overall sound level. Turn clockwise to raise volume.
- ❻ **PHONES jack:** Plugging in headphones here mutes the output to the power amplifier for private listening.
- ❼ **Tone controls:** These three controls allow you to adjust the tonal quality of the sound according to source and speaker characteristics, room acoustics and personal preferences.

A flat response (i.e. no equalization effect) is obtained in the center DEFEAT position. The turnover frequencies for the three controls are:

BASS: 350 Hz MID: 1 kHz TREBLE: 3.5 kHz

- ❽ **SUBSONIC FILTER switch:** Activates circuitry which eliminates ultra-low frequency signals caused by turntable rumble or warped records. Such interference drains amplifier power and may even harm speakers if not attenuated.
- ❾ **REC OUT selector:** Determines which source will be recorded by the connected tape and/or DAT deck. The signal of the source selected with this rotary switch is fed directly to the rear panel TAPE and DAT REC OUT jacks, regardless of the current input selector setting. This means you can listen to any source while recording another. For details on recording and dubbing, see OPERATIONS.
- ❿ **BALANCE control:** Adjusts the relative volume of the left and right channels. Use this knob to compensate for stereo imbalance due to the location of the speakers, room acoustics or the source program.
- ⓫ **MODE switch:** Switches between stereo and mono modes.
- ⓬ **PHONO MM/MC selector:** Set this switch to the position corresponding to the type of cartridge currently used by your turntable - MM (moving magnet) or MC (moving coil).
- ⓭ **Continuously variable LOUDNESS control:** This continuously variable loudness control allows you to compensate for the human ear's loss of sensitivity to low and high frequencies at low volumes. It lets you progressively attenuate the middle range in order to retain a natural balance with the bass and treble when listening at low levels. Normally, this knob should be set to the FLAT position. See below for operation details.

CONNECTIONS

Make sure the left (L) and right (R) channels are connected consistently between components.

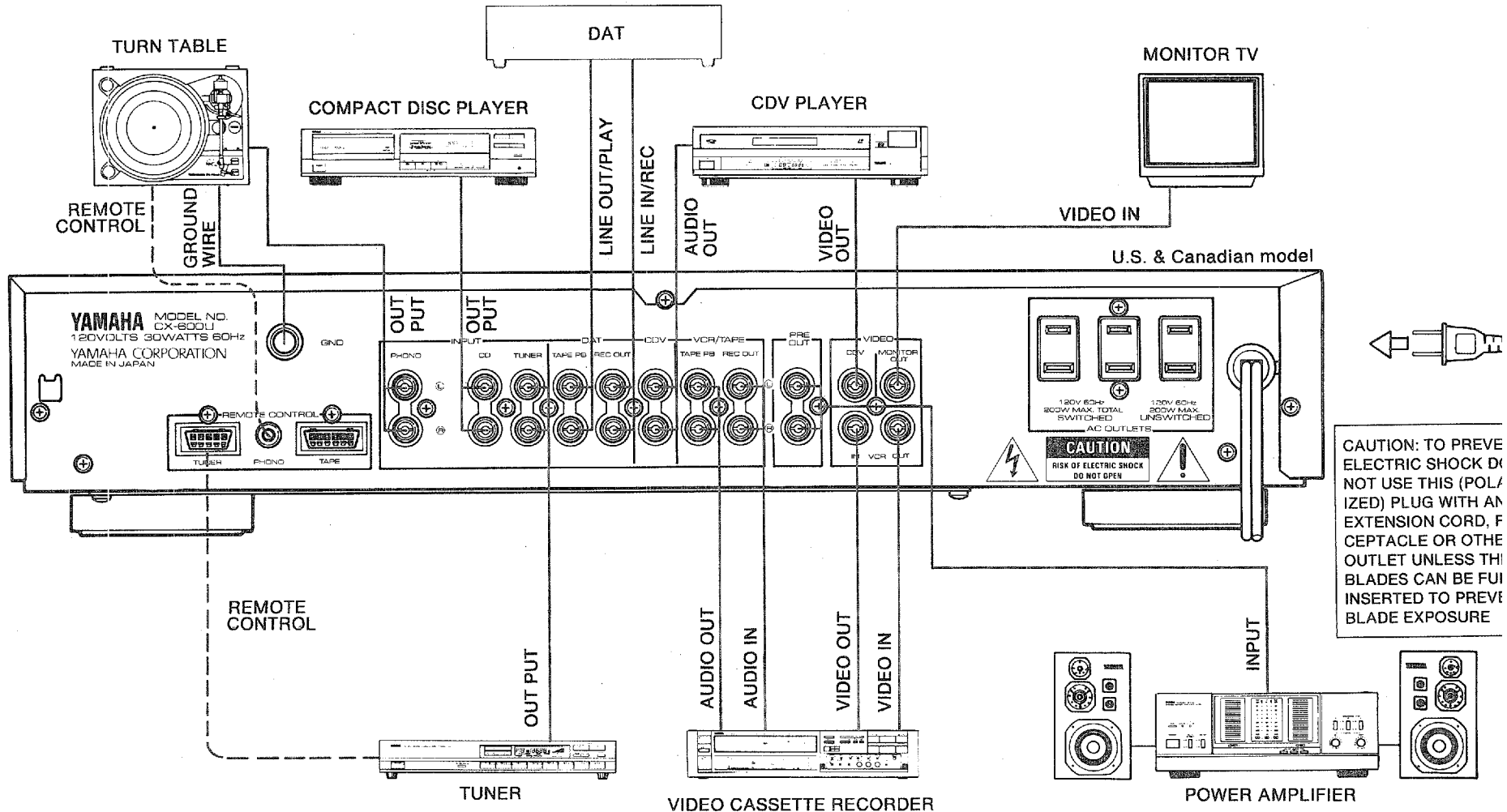

NOTE:

Before making or altering any of the connections described below, be sure to turn off all units.

Always check that

- a) the RCA plug pins of the connecting cords are clean,
- b) the left and right channels of all units correspond, and
- c) connections are made securely.

POWER AMPLIFIER

Connect the PRE OUT jacks of the CX-600/U to the INPUT jacks of your power amplifier.

AUDIO SIGNALS

■ TURNTABLE

Plug the turntable's output cords into the INPUT PHONO jacks. Partly unscrew the CX-600/U GND terminal knob and connect the turntable's ground wire, then tighten the knob. Grounding the turntable in this manner usually produces the least hum. However, the ground wire may be left disconnected if this gives better results.

■ CD PLAYER

Connect the output cords of your compact disc player to the INPUT CD jacks.

■ TUNER

Plug the cords from your tuner's output jacks into the the INPUT TUNER jacks.

■ DAT DECK

Connect the LINE OUT (or equivalent) jacks of your Digital Audio Tape deck to the DAT TAPE PB (playback) jacks, and the deck's LINE IN jacks to the REC OUT terminals. The CX-600/U's DAT terminals can also be used for connection of a second analog tape deck instead of a DAT recorder.

■ CDV PLAYER (or VDP)

Connect the L and R audio signal outputs of a CDV or video disc player to the jacks marked CDV.

■ VCR/TAPE DECK

Connections are the same as described above for a DAT deck - the LINE OUT jacks of a tape deck (or the stereo audio outputs of a video cassette recorder) are routed to the CX-600/U TAPE PB terminals, while the tape deck's LINE IN jacks (or the VCR's audio inputs) are connected to the REC OUT terminals.

VIDEO SIGNALS

■ CDV PLAYER

Use the VIDEO CDV terminal to connect the video signal output of a CDV or video disc (LaserVision) player.

■ TV SET

Connect the MONITOR OUT jack to the video input terminal of your television set or monitor.

■ VCR

Connect the video output of a VCR to the VCR IN jack. Use the VCR OUT jack for connection of the VCR's video input terminal.

REMOTE CONTROL

The remote control cables from Yamaha turntable, tuner and cassette deck models (featuring the RS mark shown below) can be connected to the REMOTE CONTROL PHONO, TUNER and TAPE terminals. These components can then be operated along with a compatible CD player and the CX-600/U itself via the remote control transmitter RS-CX600.

 The **RS** symbol indicates Yamaha **RS** integrated system remote control compatible components.

AC OUTLETS

For your convenience, the CX-600/U is equipped with three AC outlets (Australian model: one UNSWITCHED only) on the rear panel for connection of other components. Power to the two SWITCHED outlets is turned on and off by the CX-600/U power switch, while the UNSWITCHED outlet always supplies power regardless of whether this unit is on or off. Never connect components with power consumption totaling more than 200 (Australian model: 100) watts to the switched outlets or an appliance consuming more than 200 watts to the unswitched outlet.

OPERATIONS

LISTENING AND WATCHING

1. The component(s) you wish to listen to or watch should be turned on before powering up the CX-600/U.
2. Making sure that the volume control is set to minimum level, press the CX-600/U POWER switch, then turn on your power amplifier.
3. Select the desired program source by pressing the appropriate input selector and activate the selected component.
4. Adjust the VOLUME, LOUDNESS, BALANCE and tone controls as desired.

NOTE:

Either video source (CDV or VCR) always remains selected. By specifying an audio source with its input selector, you can listen to that source while watching the currently selected video program.

LOUDNESS ADJUSTMENT

When listening at low volume levels, adjust LOUDNESS by first setting this knob to the FLAT position and the VOLUME control to the maximum desired listening level. Then turn the LOUDNESS knob counterclockwise to reduce overall volume while retaining a natural sound.

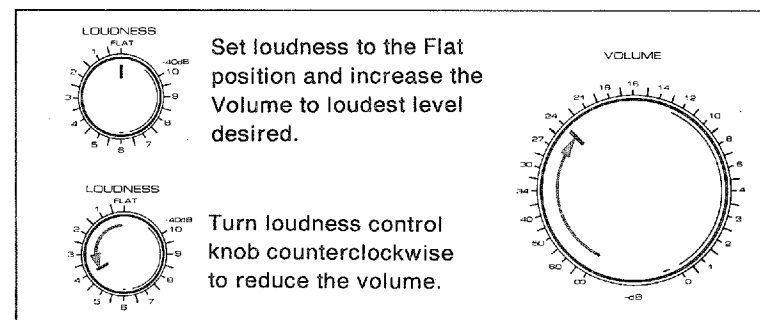

AUDIO RECORDING

Audio sources or the sound-track of video sources can be recorded either with a connected DAT/cassette deck or a VCR.

Since the source signal selected with the REC OUT selector is always present at both rear panel pairs of REC OUT jacks, audio recording is possible simultaneously with both connected decks (cassette recorder(s), DAT deck(s), VCR(s) etc.). To record from VCR/TAPE to DAT or vice versa, see "DUBBING" below.

1. Select the source you wish to record from with REC OUT.
2. Should you wish to monitor the sound while recording it, also press the corresponding input selector. (If your tape deck has three-head monitoring capability, you can listen to the sound just recorded by pressing the input selector for that deck.)
3. Activate the program source, adjust the recording level on your deck(s), then start recording.
4. While recording, you can listen to any other component without influencing the quality of the recording by simply pressing that component's input selector.

DUBBING

Dubbing, i.e. the copying of tapes or parts of tapes from one deck to another, is performed in basically the same manner as normal source recording. The REC OUT selector determines from which of two connected decks the recording will be made.

1. Select the source tape deck with REC OUT (VCR/TAPE or DAT).
2. To monitor the sound during recording, also press the corresponding input selector (VCR/TAPE or DAT).

3. Start playback of the tape to be copied, adjust the recording level on the other deck, then start recording. (Again, if the recording tape deck has three head monitoring capability, you can listen to the sound just recorded by pressing the input selector for that deck.)

4. During dubbing, you can listen to any other component without adverse effect on the recording by pressing that component's input selector.

VIDEO RECORDING

Any video source connected to the CDV jacks can be recorded with the VCR, regardless of the INPUT SELECTOR setting.

1. Set the REC OUT selector to CDV.
2. Should you wish to monitor the sound and video image while recording it, also select CDV with the INPUT SELECTOR.
3. Set the VCR to the record mode, then start playback of the video source.

NOTE:

When another audio source is selected with REC OUT selector, the CDV image can be recorded combined with the sound from another audio source.

1. Set the REC OUT selector to the chosen audio source.
2. Set the VCR to the record mode, then start playback of the video source and selected audio source.

If "VCR" is then selected with the INPUT SELECTOR, the image and the sound now being recorded can be confirmed.

REMOTE CONTROL

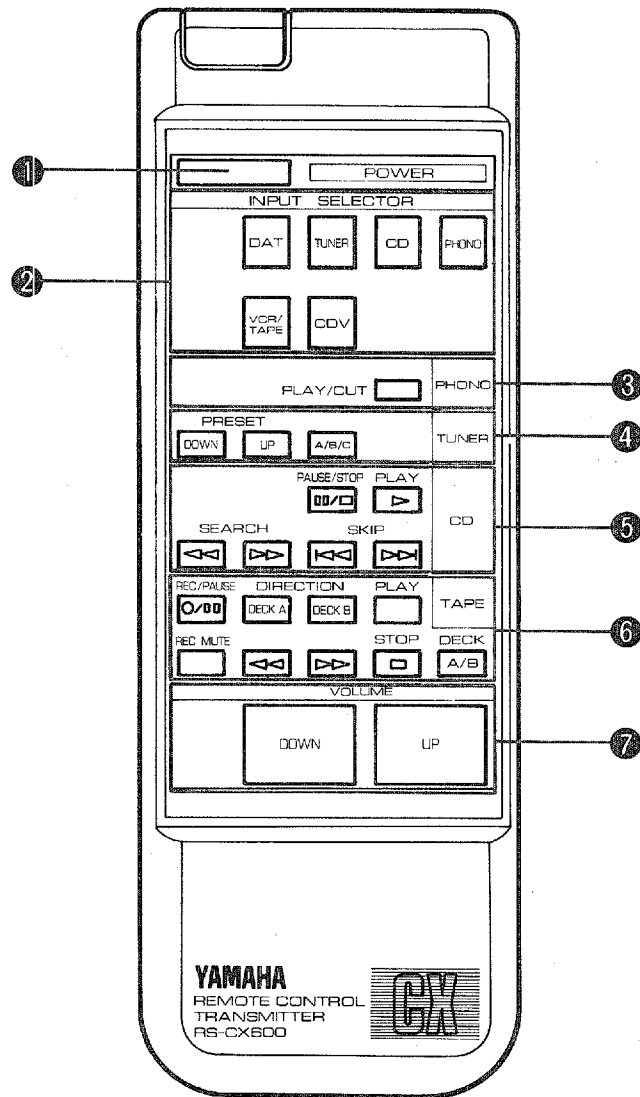

The supplied remote control transmitter RS-CX600 can be used to operate the CX-600/U itself as well as Yamaha remote controlled components featuring the RS Mark (turntable, tuner, cassette deck and compact disc player) from the comfort of your chair. See the section CONNECTIONS for information on how to connect these components to the CX-600/U for remote control. Note that no cable is necessary for remote control of a compatible CD player. Also see the operation manuals of the respective components for details on operation.

KEYS AND THEIR FUNCTIONS

- ① **POWER key**
Turns the CX-600/U on or off.
- ② **INPUT SELECTOR keys**
These have the same function as the front panel input selector:
- ③ **PHONO PLAY/CUT key**
Starts or stops the connected turntable.
- ④ **TUNER keys**
These keys let you select the desired preset station on the tuner
 - **A/B/C**
Switches between the two or three banks of station presets.
 - **UP and DOWN**
Pressing these keys switches to the next higher (UP) or lower (DOWN) preset station.

⑤ CD keys

- **PLAY** ▷
Press to start CD playback.
- **PAUSE/STOP** 00/□
Press once to temporarily stop playback (pause mode). Press once again to enter stop mode.
- **SEARCH** <</>>
Use these keys to search forward or backward.
- **SKIP** <</>>
Use these keys to skip to the beginning of the current, previous or next selection.

⑥ TAPE keys

- **DECK A/B**
If you are using a double cassette deck, this button switches between decks.
- **DIRECTION (DECK A, DECK B)**
Switches the tape direction between forward and backward.
- **PLAY, STOP, <<, >>, REC MUTE, REC/PAUSE**
These buttons have the same functions as the corresponding switches on the tape deck's front panel.

⑦ VOLUME keys

Use these to raise (UP) or lower (DOWN) the volume of the CX-600/U.

BATTERY INSTALLATION

Install two AA batteries into the transmitter as shown below, taking care that the poles correspond to the illustration on the battery compartment floor. Remove them when not using the transmitter for an extended period of time.

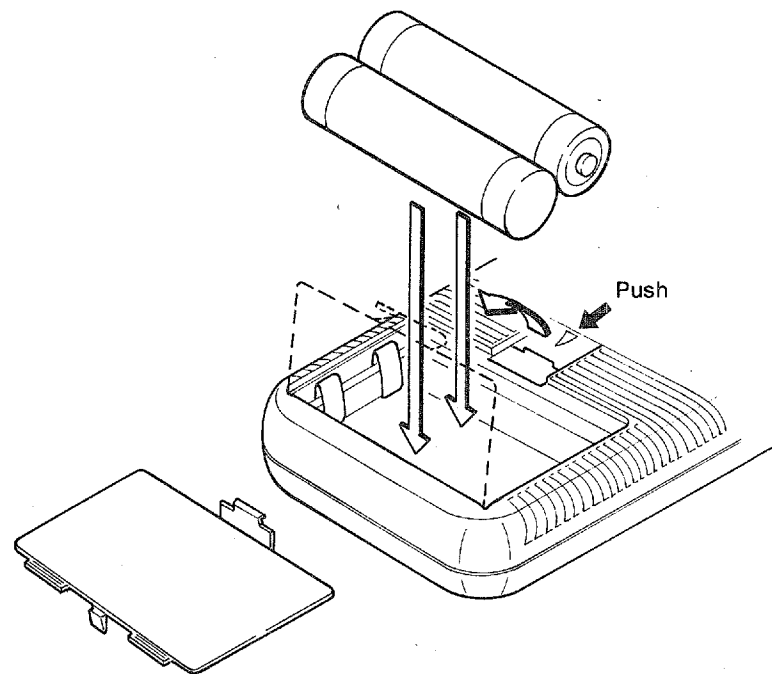

REMOTE CONTROL RANGE

The transmitter can be used from a distance of up to about 7 meters (23 feet) from the control amplifier and must be aimed in its direction for proper operation.

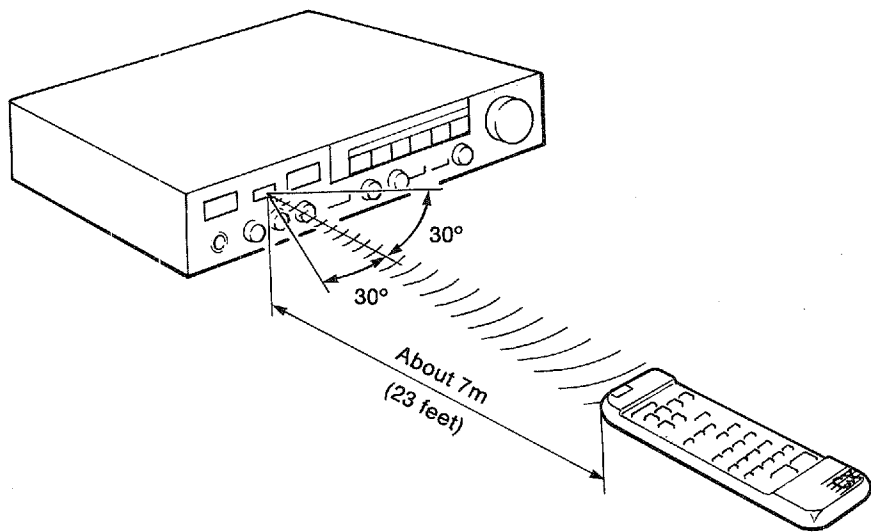

BATTERY REPLACEMENT

When you notice that the remote control no longer works from greater distances, replace the batteries, observing the following precautions:

- Replace weak batteries before they run down completely.
- Always replace both batteries with new ones.
- Do not use different kinds of batteries at the same time.
- In case electrolyte has leaked into the battery compartment, wipe it off completely before installing new batteries.
- Never disassemble, heat or throw discarded batteries into a fire. Dispose of them properly.

TROUBLESHOOTING

Before assuming that your amplifier is faulty, check the following list. If you still have any doubts or questions, contact your nearest YAMAHA dealer.

Symptom	Possible cause	Remedy
No power even when the POWER switch is ON.	● The power cord is not plugged in securely.	● Plug in securely.
No sound is heard.	● The wrong source is selected.	● Press the input selector for the desired source.
	● Power amp connections are not secure.	● Properly plug in connection cord.
	● Source input connections are not secure.	● Properly plug in connection cord.
One channel sounds louder than the other.	● Left/right channels out of balance.	● Adjust the BALANCE control.
Sound from MC cartridge too low.	● PHONO MM/MC selector set to MM.	● Push in this switch to the MC position.
A loud humming sound is heard when PHONO is selected.	● Turntable is not properly grounded.	● Connect the turntable's ground wire to GND (or disconnect if this gives better results).
Recording not possible.	● REC OUT selector improperly set.	● Switch REC OUT to the source you want to record.

SPECIFICATIONS

Input Sensitivity/Impedance	
Phono MC	100 μ V/100 Ω
Phono MM	2.5mV/47k Ω
CD/VIDEO/TUNER/CDV/TAPE/VCR	150mV/47k Ω
Input Sensitivity (New IHF)	
Phono MC	33 μ V
Phono MM	0.83mV
CD/VIDEO/TUNER/CDV/TAPE/VCR	50mV
Maximum-Input Signal	
1kHz, 0,003% THD, Phono MC	7mV
1kHz, 0,001% THD, Phono MM	170mV
Output Level/Impedance	
REC OUT	150mV/330 Ω
PRE OUT	1.5V/47 Ω
Maximum Voltage Output	
20Hz ~ 20kHz, 0.1% THD, PRE OUT	\geq 8.5V
Headphone Jack Rated Output/Impedance	
0.1% THD, RL = 150 ohms	4.2V/82 Ω
Frequency Response (20Hz ~ 20kHz)	
CD/VIDEO/TUNER/CDV/TAPE/VCR	0 \pm 0.2dB
RIAA Equalization Deviation	
20Hz ~ 20kHz, Phono MC/MM	\pm 0.3/ \pm 0.2dB
10Hz ~ 100kHz, Phono MM	\pm 0.5dB
20Hz ~ 100kHz, Phono MC	\pm 0.5dB
Total Harmonic Distortion (20Hz ~ 20kHz)	
Phono MC to REC OUT, 3V	0.002%
Phono MM to REC OUT, 3V	0.002%
CD/VIDEO/TUNER/CDV/TAPE/VCR to PRE OUT, 3V (SOURCE DIRECT ON)	0.002%
Signal to Noise Ratio (IHF-A-Network)	
Phono MC (500 μ V Input Shorted)	84dB
Phono MM (5mV Input Shorted)	94dB
SOURCE DIRECT (shorted)	106dB
Signal to Noise Ratio (New IHF)	
Phono MC	79dB
Phono MM	80dB
CD/VIDEO/TUNER/CDV/TAPE/VCR	92dB

Residual Noise (IHF-A-Network)		8 μ V
Channel Separation Vol Max		
Phono MC, MM input shorted, 1kHz/10kHz		80dB/70dB
CD/VIDEO/TUNER/CDV/TAPE/VCR input 5.1k Ω terminated, 1kHz/10kHz		70dB/60dB
Tone Control Characteristics		
BASS	boost/cut	\pm 10dB (20Hz turnover frequency)
TREBLE	boost/cut	\pm 10dB (20kHz turnover frequency)
MID	control range	\pm 10dB (1kHz center frequency)
Video Input Sensitivity/Impedance		
CDV, VCR		1Vp-p/75 Ω
Video Output Level/Impedance		
MONITOR OUT, VCR OUT		1Vp-p/75 Ω
Filter Characteristics		
Subsonic		15Hz — 12dB/oct
Continuous Loudness Control (Level related equalization)		
Attenuation		-40dB (1kHz)
Gain tracking error (0 ~ -60dB)		2dB
Power Supply		
U.S.A., Canada		AC120V, 60Hz
Australia		AC240V, 50Hz
General		AC110/120/220/240V, 60/50Hz
Power Consumption		30W
AC Outlet		
Switched	U.S.A., Canada	200W max
	Australia	100W max
	General	200W max
Unswitched	U.S.A., Canada	200W max
	General	200W max
Dimensions (W x H x D)		435 x 83 x 298mm (17-1/8" x 3-17/64" x 11-47/64")
Weight		4.7kg

Specifications subject to change without notice.

YAMAHA