

# YAMAHA

# G50

## GUITAR MIDI CONVERTER

ENGLISH

DEUTSCH

FRANÇAIS

**Owner's Manual  
Bedienungsanleitung  
Mode d'emploi**



# FCC INFORMATION (U.S.A.)

## 1. IMPORTANT NOTICE: DO NOT MODIFY THIS UNIT!

This product, when installed as indicated in the instructions contained in this manual, meets FCC requirements. Modifications not expressly approved by Yamaha may void your authority, granted by the FCC, to use the product.

**2. IMPORTANT:** When connecting this product to accessories and/or another product use only high quality shielded cables. Cable/s supplied with this product MUST be used. Follow all installation instructions. Failure to follow instructions could void your FCC authorization to use this product in the USA.

**3. NOTE:** This product has been tested and found to comply with the requirements listed in FCC Regulations, Part 15 for Class "B" digital devices. Compliance with these requirements provides a reasonable level of assurance that your use of this product in a residential environment will not result in harmful interference with other electronic devices. This equipment generates/uses radio frequencies and, if not installed and used according to the instructions found in the users manual, may cause interference harmful to the operation of other electronic devices. Compliance with FCC

regulations does not guarantee that interference will not occur in all installations. If this product is found to be the source of interference, which can be determined by turning the unit "OFF" and "ON", please try to eliminate the problem by using one of the following measures:

Relocate either this product or the device that is being affected by the interference.

Utilize power outlets that are on different branch (circuit breaker or fuse) circuits or install AC line filter/s.

In the case of radio or TV interference, relocate/reorient the antenna. If the antenna lead-in is 300 ohm ribbon lead, change the lead-in to co-axial type cable.

If these corrective measures do not produce satisfactory results, please contact the local retailer authorized to distribute this type of product. If you can not locate the appropriate retailer, please contact Yamaha Corporation of America, Electronic Service Division, 6600 Orangethorpe Ave, Buena Park, CA90620

The above statements apply ONLY to those products distributed by Yamaha Corporation of America or its subsidiaries.

\* This applies only to products distributed by YAMAHA CORPORATION OF AMERICA.

## NEDERLAND / NETHERLAND

- Dit apparaat bevat een lithium batterij voor geheugen back-up.
- This apparatus contains a lithium battery for memory back-up.
- Raadpleeg uw leverancier over de verwijdering van de batterij op het moment dat u het apparaat aan het einde van de levensduur afdankt of de volgende Yamaha Service Afdeling:  
Yamaha Music Nederland Service Afdeling  
Kanaalweg 18-G, 3526 KL UTRECHT  
Tel. 030-2828425
- For the removal of the battery at the moment of the disposal at the end of the service life please consult your retailer or Yamaha Service Center as follows:  
Yamaha Music Nederland Service Center  
Address : Kanaalweg 18-G, 3526 KL UTRECHT  
Tel : 030-2828425
- Gooi de batterij niet weg, maar lever hem in als KCA.
- Do not throw away the battery. Instead, hand it in as small chemical waste.

## ADVARSEL!

Lithiumbatteri—Eksplosionsfare ved fejlagtig håndtering. Udskiftning må kun ske med batteri af samme fabrikat og type. Levér det brugte batteri tilbage til leverandoren.

## VARNING

Explosionsfara vid felaktigt batteribyte. Använd samma batterityp eller en ekvivalent typ som rekommenderas av apparattillverkaren. Kassera använt batteri enligt fabrikantens instruktion.

## VAROITUS

Paristo voi räjähtää, jos se on virheellisesti asennettu. Vaihda paristo ainoastaan laitevalmistajan suosittelemaan tyyppiin. Hävitä käytetty paristo valmistajan ohjeiden mukaisesti.

# SPECIAL MESSAGE SECTION

This product utilizes batteries or an external power supply (adapter). DO NOT connect this product to any power supply or adapter other than one described in the manual, on the name plate, or specifically recommended by Yamaha.

**WARNING:** Do not place this product in a position where anyone could walk on, trip over, or roll anything over power or connecting cords of any kind. The use of an extension cord is not recommended! IF you must use an extension cord, the minimum wire size for a 25' cord (or less) is 18 AWG. NOTE: The smaller the AWG number, the larger the current handling capacity. For longer extension cords, consult a local electrician.

This product should be used only with the components supplied or a cart, rack, or stand that is recommended by Yamaha. If a cart, etc., is used, please observe all safety markings and instructions that accompany the accessory product.

## **SPECIFICATIONS SUBJECT TO CHANGE:**

The information contained in this manual is believed to be correct at the time of printing. However, Yamaha reserves the right to change or modify any of the specifications without notice or obligation to update existing units.

This product, either alone or in combination with an amplifier and headphones or speaker/s, may be capable of producing sound levels that could cause permanent hearing loss. DO NOT operate for long periods of time at a high volume level or at a level that is uncomfortable. If you experience any hearing loss or ringing in the ears, you should consult an audiologist.

**IMPORTANT:** The louder the sound, the shorter the time period before damage occurs.

Some Yamaha products may have benches and / or accessory mounting fixtures that are either supplied with the product or as optional accessories. Some of these items are designed to be dealer assembled or installed. Please make sure that benches are stable and any optional fixtures (where applicable) are well secured BEFORE using.

Benches supplied by Yamaha are designed for seating only. No other uses are recommended.

## **NOTICE:**

Service charges incurred due to a lack of knowledge relating to how a function or effect works (when the unit is operating as designed) are not covered by the manufacturer's warranty, and are therefore the owners responsibility. Please study this manual carefully and consult your dealer before requesting service.

## **ENVIRONMENTAL ISSUES:**

Yamaha strives to produce products that are both user safe and environmentally friendly. We sincerely believe that our products and the production methods used to produce them, meet these goals. In keeping with both the letter and the spirit of the law, we want you to be aware of the following:

## **Battery Notice:**

This product MAY contain a small non-rechargeable battery which (if applicable) is soldered in place. The average life span of this type of battery is approximately five years. When replacement becomes necessary, contact a qualified service representative to perform the replacement.

This product may also use "household" type batteries. Some of these may be rechargeable. Make sure that the battery being charged is a rechargeable type and that the charger is intended for the battery being charged.

When installing batteries, do not mix batteries with new, or with batteries of a different type. Batteries MUST be installed correctly. Mismatches or incorrect installation may result in overheating and battery case rupture.

## **Warning:**

Do not attempt to disassemble, or incinerate any battery. Keep all batteries away from children. Dispose of used batteries promptly and as regulated by the laws in your area. Note: Check with any retailer of household type batteries in your area for battery disposal information.

## **Disposal Notice:**

Should this product become damaged beyond repair, or for some reason its useful life is considered to be at an end, please observe all local, state, and federal regulations that relate to the disposal of products that contain lead, batteries, plastics, etc. If your dealer is unable to assist you, please contact Yamaha directly.

## **NAME PLATE LOCATION:**

The name plate is located on the top of the product, and the serial number is located at the rear of the product. The power requirements, etc., are located on this plate. You should record the serial number, and the date of purchase in the spaces provided below and retain this manual as a permanent record of your purchase.

**Model** **G50**

---

**Serial No.**

---

**Purchase Date**

---

# PLEASE KEEP THIS MANUAL

*The G50 is a high-performance Guitar MIDI Converter designed to work in conjunction with the Yamaha G1D Divided Pickup Unit installed on an electric or steel-string acoustic guitar. The G50 offers unprecedented MIDI guitar synthesizer performance with exceptionally fast response and a range of advanced features that bring the true creative potential of MIDI control to guitar players for the first time. A MIDI guitar system incorporating the G50 and G1D is not only great for performance, but it gives guitar players an ideal means for entering music data in a MIDI sequence recording system.*

*Please read this owner's manual carefully, and follow the instructions within in order to ensure proper operation. Also keep this manual in a safe place for later reference.*

---

## Contents

---

Precautions .....	2
G50 Overview .....	3
The Controls & Connectors .....	4
Front Panel .....	4
Rear Panel .....	5
Setting Up .....	6
■ Power Supply .....	6
■ Tone Generator Connection & MIDI Setup .....	6
MIDI Channel Settings .....	7
Preset Program Sets .....	8
■ Guitar/G1D Connection .....	8
Input Level Adjustment .....	9
Tuning .....	10
Play Mode .....	11
Selecting Programs & Playing In the PLAY Mode .....	11
G1D [UP]/[DOWN] Button Modes .....	12
Playing In the Monophonic Mode .....	12
Edit Mode .....	13
• Edit and Write Operation .....	13
• The Memory Swap Function .....	13
Guitar Setup .....	14
Tone Generator Setup .....	15
Real Time Control .....	16
MIDI Bulk Dump Transmission & Reception .....	19
Initialize .....	20
Specifications .....	20
Troubleshooting .....	21
Preset Program Lists .....	22
■ Guitar/Bass select switch: when "GUITAR" is selected .....	22
■ Guitar/Bass select switch: when "BASS" is selected .....	25
MIDI Data Format .....	28
MIDI Implementation Chart .....	32

---

# Precautions

!! PLEASE READ THIS BEFORE PROCEEDING !!

## ■ Location

Do not expose the G50 to the following conditions to avoid deformation, discoloration, or more serious damage.

- Direct sunlight (e.g. near a window).
- High temperatures (e.g. near a heat source, outside, or in a car during the daytime).
- Excessive humidity.
- Excessive dust.
- Strong vibration.

## ■ USE THE CORRECT POWER SUPPLY

Power to the G50 should be supplied only from the appropriate Yamaha AC adaptor (the PA-3B or another adaptor specifically recommended by Yamaha). Use of another adaptor may cause serious damage to the unit. Also make sure that the adaptor you have is appropriate for the AC mains supply voltage in the area where you intend to use the G50. (The correct input voltage is marked on the adaptor.)

## ■ Power Supply

- Turn the power switch OFF when the instrument is not in use.
- The power adaptor should be unplugged from the AC outlet if the G50 is not to be used for an extended period of time.
- Unplug the G50 during electric storms.
- Avoid plugging the G50 into the same AC outlet as appliances with high power consumption, such as electric heaters or ovens. Also avoid using multi-plug adaptors since these can result in reduced sound quality and possibly damage.

## ■ Turn Power OFF When Making Connections

- To avoid damage to the G50 and other devices to which it is connected (a sound system, for example), turn the power switches of all related devices OFF prior to connecting or disconnecting audio and MIDI cables.

## ■ MIDI Connections

- When connecting the G50 to MIDI equipment, be sure to use high-quality cables made especially for MIDI data transmission.
- Avoid MIDI cables longer than about 15 meters. Longer cables can pick up electrical noise that can cause data errors.

## ■ Handling and Transport

- Never apply excessive force to the controls, connectors or other parts of the instrument.
- Always unplug cables by gripping the plug firmly, not by pulling on the cable.
- Disconnect all cables before moving the instrument.
- Physical shocks caused by dropping, bumping, or placing heavy objects on the instrument can result in scratches and more serious damage.

## ■ Cleaning

- Clean the cabinet and panel with a dry soft cloth.
- A slightly damp cloth may be used to remove stubborn grime and dirt.
- Never use cleaners such as alcohol or thinner.
- Avoid placing vinyl objects on top of the instrument (vinyl can stick to and discolor the surface).

## ■ Electrical Interference

- This instrument contains digital circuitry and may cause interference if placed too close to radio or television receivers. If this occurs, move the instrument further away from the affected equipment.

## ■ Data Backup

- The G50 contains a special long-life battery that retains the contents of its internal memory even when the power is turned OFF. The backup battery should last for several years. When the backup battery needs to be replaced “BALo” will appear on the display when the power is turned on. When this happens, have the backup battery replaced by qualified Yamaha service personnel. **DO NOT ATTEMPT TO REPLACE THE BACKUP BATTERY YOURSELF!**

## ■ Service and Modification

- The G50 contains no user serviceable parts. Opening it or tampering with it in any way can lead to irreparable damage and possibly electric shock. Refer all servicing to qualified YAMAHA personnel.

YAMAHA is not responsible for damage caused by improper handling or operation.

# G50 Overview

The G50 is basically an “interface” which converts the analog output from a G1D Divided Pickup Unit installed on your guitar (or directly from the guitar’s normal output if used without the G1D in the mono synthesizer mode) to corresponding MIDI data which is transmitted to a MIDI tone generator to produce the “synthesized” sound output. When you play a note or chord on your guitar, the G50 instantly generates MIDI data corresponding to the note(s) you play — along with the appropriate pitch bend data if

you bend a note — so that you can use most standard guitar techniques to play any voice that can be produced by the connected MIDI tone generator — brass, strings, organ, percussion ... anything! You can play just the synthesized sound, mix the synthesized sound with the normal guitar sound played through a standard guitar amplifier or sound system, or just play the normal guitar sound.

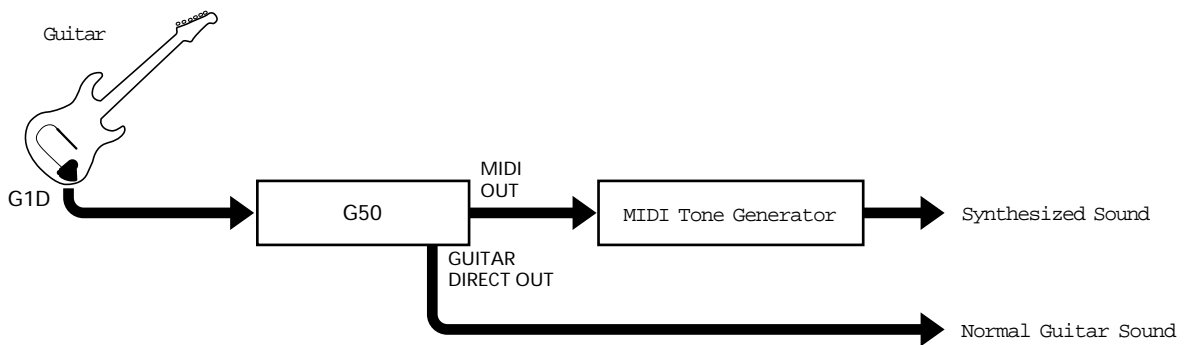

The G50 has 128 “programs” that you can select and play. In fact, you can edit each of these programs to provide precisely the response and playing features you want. You can, for example, specify the G50’s sensitivity in response to notes you play on the guitar, the pitch bend range, which voice on your tone generator will be selected when the G50 program is selected, and much more. There are also special “split” functions which let you play different voices on different strings, or different voices at different picking positions. You could, for example, play upright bass on the lowest two strings (5 and 6) while playing organ on the top 4 strings (1 through 4). The G50 offers many other features that provide an extraordinary range of creative possibilities.

● “Split” function example

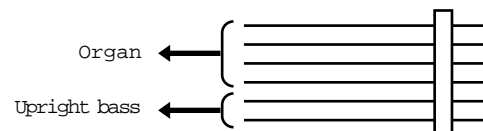

---

# The Controls & Connectors

---

## Front Panel

---

### 1 [POWER] Switch

Press to turn the G50 power on or off. The PARAMETER & MEMORY#/VALUE display will light when the power is on.

### 2 INPUT-DIVIDED Connector

One end of the multi-pin cable supplied with the G50 plugs in here. The cable plugs in with the release button facing upward. This is a locking connector — the release button must be pressed to unplug the cable. The other end of cable connects to the G1D Divided Pickup Unit (refer to the G1D owner's manual for details).

### 3 MONO SYNTH Jack

The normal output from a guitar can be plugged in here via a standard 1/4" phone-plug cable if the G50 is to be used without the G1D Divided Pickup Unit in the monophonic mode. The monophonic mode is automatically selected when the multi-pin cable is disconnected and a standard guitar cable is plugged in here.

*Page 7 for details.*

### 4 PARAMETER & MEMORY#/VALUE Display

This display shows the current program number when the G50 is in the PLAY mode, and the appropriate parameters and/or values when any other mode is engaged.

### 5 [PLAY] Button

This button engages the normal G50 PLAY mode (the PLAY mode is selected by default whenever the G50 power switch is turned ON). Any of the G50's 128 "programs" can be selected and played in this mode.

*Page 11 for details.*

### 6 [INPUT] Button

Engages the input adjustment mode in which the G50 input gain can be matched to the output level of each individual guitar string for optimum playability and performance.

*Page 9 for details.*

### 7 [TUNER] Button

Engages the G50's built-in guitar tuner, allowing precise, easy tuning of each guitar string. If pressed while holding the [PLAY] button, the [TUNER] button also accesses a selection of preset program sets.

*Pages 10, 8 for details.*

### 8 [MIDI] Button

Allows the MIDI transmit/receive channel(s) of the G50 to be set to match the connected MIDI device(s).

It is also possible to transmit MIDI bulk data corresponding to the G50's 128 programs to an external storage device by pressing the [MIDI] button while holding the [PLAY] button.

*Page 19 for details.*

### 9 PARAMETER SELECT [▲](NO) and [▼](YES) Buttons

These buttons are used to select the G50's editable parameters ("A" through "Y"). Press either button briefly to select the next parameter in the corresponding direction ([▼] to select the next parameter toward "Y", or [▲] to select the next parameter toward "A"), or hold either button for continuous scrolling in the corresponding direction.

These same buttons are also used to confirm ("YES") or cancel ("NO") the G50 program copy, swap, and other functions.

*Page 13 for details.*

### J MEMORY#/VALUE [-1] & [+1] Buttons

These buttons are used to increment (increase) or decrement (decrease) program numbers or the value/setting of any of the G50's editable parameters. Press either button briefly to select the next number/setting in the corresponding direction ([+1] to increment; [-1] to decrement), or hold either button for continuous scrolling in the corresponding direction. It is also possible to skip in tens (e.g. 10 → 20 → 30 → etc. or the reverse) by pressing the opposite button while holding the button corresponding to the direction in which you want to increment/decrement.

## Rear Panel

### K DC IN Connector

The DC output cable from the Yamaha PA-3B AC adaptor or another adaptor recommended by Yamaha is plugged in here.

*Page 6 for details.*

### L GUITAR DIRECT OUT Jack

This jack outputs the direct sound from your guitar (not the synthesized sound). The output from this jack can be connected to a guitar amplifier, mixing console, or similar device via a standard 1/4" phone plug cable.

### M GUITAR TYPE Switch

This switch must be set to match the type of guitar and divided pickup you are using. If you have a G1D Divided Pickup Unit installed on a six-string guitar, set this switch to the "GUITAR" position. If you have a bass guitar divided pickup installed on a bass guitar, set the switch to the "BASS" position after the turned power off. "BASS" will appear on the display briefly when the power is turned on after setting this switch to "BASS",

### N SUSTAIN/HOLD Jack

A Yamaha FC4 or FC5 footswitch can be connected to this jack for sustain or hold operation.

*Page 18 for details.*

### O MIDI IN and OUT Connectors

The MIDI OUT connector connects to one or more external tone generators or synthesizers to be driven by the G50. It can also be connected to a MIDI data recorder or other MIDI data storage device to store MIDI bulk data corresponding to the G50's 128 programs.

The MIDI IN connector can be used to receive previously stored program data from an external MIDI data storage device, or control data from a device such as a Yamaha MFC10 MIDI Foot Controller.

*Page 6 for details.*

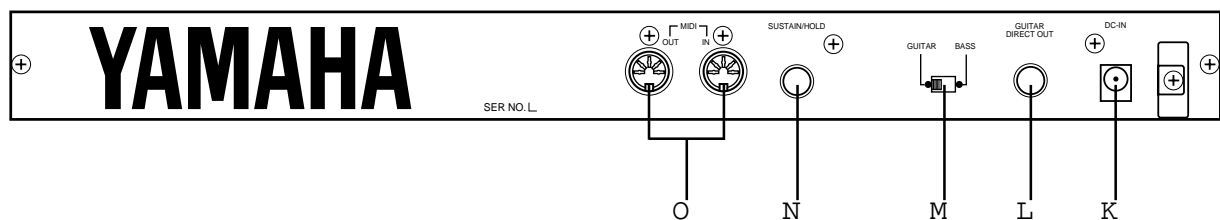
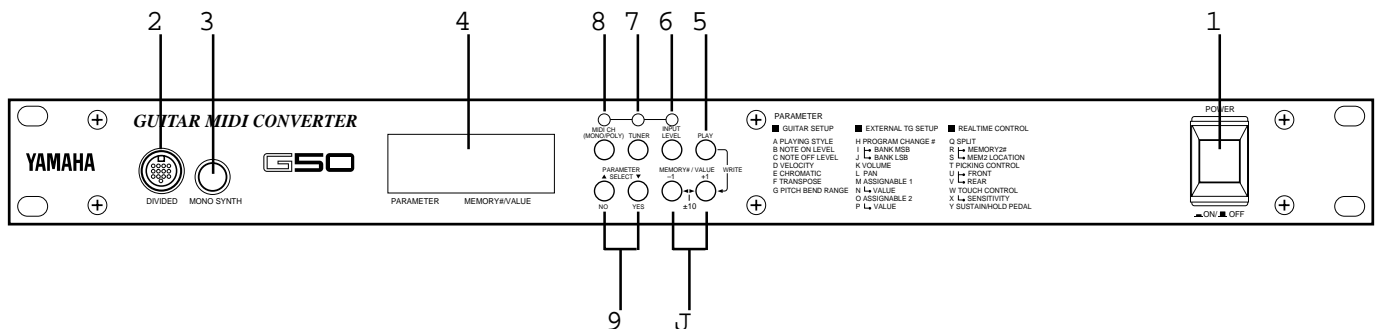



# Setting Up

## Power Supply

Plug the DC output cable from the AC adaptor into the DC IN jack on the rear panel, then plug the adaptor into a convenient wall AC power socket. It is also a good idea to clip the adaptor's DC cable into the cable clip on the G50 rear panel to minimize the possibility of accidentally unplugging the cable during operation.

### ■ CAUTION

- Turn your tone generator on before turning on the G50. This is necessary to ensure that the initial pitch bend, tune, and other setup parameters transmitted by the G50 at power-on are received by the tone generator.
- Do not attempt to use an AC adaptor other than the supplied unit or an appropriate replacement provided by your Yamaha dealer to power the G50. The use of an incompatible adaptor may cause irreparable damage to the G50, and might pose a serious shock hazard!
- Be sure to unplug the AC adaptor from the AC mains socket when the G50 is not in use.

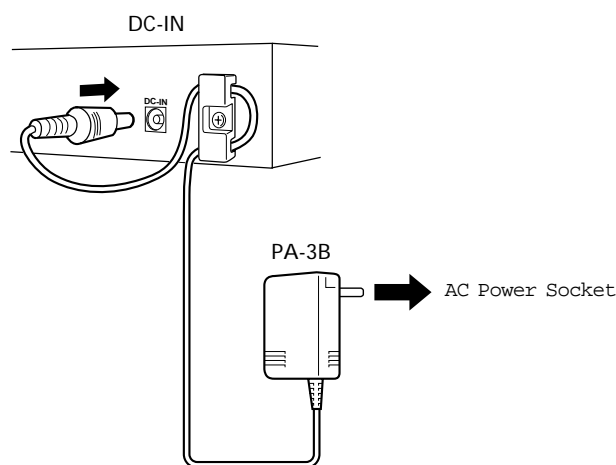

## Tone Generator Connection & MIDI Setup

The G50 can drive just about any external tone generator or synthesizer, although Yamaha particularly recommends the MU80 or MU50 XG (GM compatible) tone generators for outstanding AWM sound, or the VL1-m Version 2 or VL70-m if you want the extraordinary sound of Yamaha's revolutionary Virtual Acoustic Synthesis tone generation system.

Connect the G50 MIDI OUT connector to the MIDI IN connector of a single external device, or the first in a "chain" of devices you want to control. The MIDI THRU connector of the first device in the chain should then be connected to the MIDI IN connector of the second device, and so on. See below for details on setting the G50 MIDI transmit/receive channel(s).

### ■ NOTES

- Always use high-quality MIDI cables when connecting MIDI devices, and avoid cables longer than about 15 meters – longer cables can pick up electrical noise that can cause data errors.
- Keep to turned the power off before the installing.

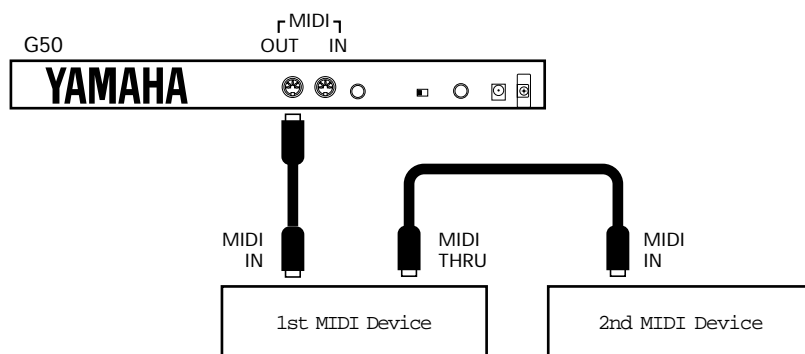

## MIDI Channel Settings

The G50 has three MIDI channel modes. Be sure to select the right mode for the type of tone generator and setup you are using.

### Multi-channel Mode



(settings "S 1" through "S 16" on the G50 display).

In this mode the MIDI data derived from each individual guitar string is transmitted from the G50 via a different MIDI channel. This mode is suited for use with a "multi-timbral" tone generator such as the Yamaha MU80 or MU50. This mode is fully polyphonic (i.e. you can play chords), and with a multi-timbral tone generator it is possible to have each guitar string play a different voice.

- The MIDI receive channel is set to the "base" channel (i.e. the channel assigned to the guitar's 1's string).
- See the "Multi-channel Mode Settings" chart, below, for the actual MIDI channel numbers assigned to each string.
- Since MIDI channel number 10 is reserved for drums and rhythm in many multi-timbral applications, channel 10 is not available in the Multi-channel Mode.
- If you want to connect a bass to the G50, set the GUITAR TYPE switch on the rear panel to the "BASS" position after turning off the power.
- When a bass is used, pick up speed may be slower than guitar.

#### ● Multi-channel Mode Settings

Setting	HOLD	String						
		6	5	4	3	2	1	
S1	7	6	5	4	3	2	1	
S2	8	7	6	5	4	3	2	
S3	9	8	7	6	5	4	3	
S4	11	9	8	7	6	5	4	
S5	12	11	9	8	7	6	5	
S6	13	12	11	9	8	7	6	
S7	14	13	12	11	9	8	7	
S8	15	14	13	12	11	9	8	
S9	16	15	14	13	12	11	9	
S11	1	16	15	14	13	12	11	
S12	2	1	16	15	14	13	12	
S13	3	2	1	16	15	14	13	
S14	4	3	2	1	16	15	14	
S15	5	4	3	2	1	16	15	
S16	6	5	4	3	2	1	16	

The "HOLD" channel in the above chart is used by the G50 hold function, described on page 18.

### Single-channel Polyphonic Mode



(settings "C 1" through "C 16" on the G50 display).

In this mode the MIDI data derived from all strings is transmitted from the G50 on the single specified MIDI channel (1 through 16). This mode can be used

with tone generators or synthesizers which only allows reception on a single MIDI channel at a time, and is the best choice for use with a monophonic tone generator such as the Yamaha VL1-m Version 2 (of course it can also be used with multi-timbral tone generators). The Single-channel Polyphonic Mode is also ideal for MIDI recording applications (i.e. when recording the output of the G50 to a MIDI sequencer). This mode is fully polyphonic so you can play chords, but since pitch bend data is derived from the last note played the results of double-choking techniques may not be exactly as expected. Further, if you bend a note more than a semitone, the pitch will "jump" a semitone.

- The MIDI receive channel in this mode is the same as the transmit channel.
- The next highest channel is used by the G50 hold function. (e.g. if "C3" is selected, channel 4 is used for the hold function.)

### Monophonic Mode



(settings "M 1" through "M 16" on the G50 display).

This mode is automatically selected when the multi-pin cable is unplugged and a standard guitar cable is plugged into the G50 MONO SYNTH jack (see page 5 for details). The data for all strings is transmitted on the single specified MIDI channel, and only one note can be played at a time.

- The Q: Split, T: Picking Position Control and A: Playing Style functions have no effect in this mode.
- The MIDI receive channel in this mode is the same as the transmit channel.

#### ■ To Select a MIDI Mode & Channel Setting:

- 1 Engage the MIDI Mode  
Press the [MIDI] button. The indicator above the [MIDI] button will light.
- 2 Select a Mode/Setting  
Use the [-1] and [+1] buttons to select the desired MIDI mode and channel setting: "'S 1" through "S 16" ("M 1" through "M 16") or "C 1" through "C 16". The "S" and "M" modes are switched automatically.



S, C, M

- 3 Return to the PLAY Mode  
Press the [PLAY] button to return to the PLAY mode.

## Preset Program Sets

In addition to the normal “user” programs, the G50 has 3 preset program sets designed specifically for use with certain tone generators, as follows:

**U**

This is the normal user-programmable G50 memory. The factory preset program conform to the standard GM (General MIDI) voice assignments.

**1**

The “1” preset program set contains a selection of programs designed for use with the Yamaha MU80 or MU50.

**2**

This set has been created for use with the Yamaha VL70-m.

**3**

This set has been created for use with the Yamaha VL1-m Version 2.

■ **To Select a Preset Program Set:**

1. Engage the Preset Selection Mode  
Press the [TUNER] button while holding the [PLAY] button. “TG” followed by the number of the currently selected preset program set (or “U” for “user”) will flash on the display.

2. Select a Preset  
Select the desired preset program set by using the [-1] and [+1] buttons.

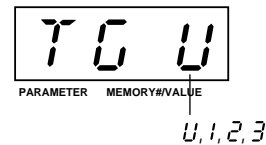

3. Press [YES]  
Press the [YES] button to confirm the selection. “don” will appear briefly when the selected preset program set has been activated. When preset “2” or “3” is selected, pressing the [YES] button also transmits appropriate voice data to the connected VL70-m or VL1-m Version 2. Make sure your VL70-m or VL1-m Version 2 is set up to allow voice data (system exclusive) reception if you want to use these voices. This voice data will overwrite the previous data in voice number “Cst 001 through 006 and Int 001”(VL70-m) or “A01 through A06”(VL1-m Version 2), so be sure any data you want to keep is backed up before selecting either of these program sets.

■ **NOTES**

- The user data is kept safe in a special secondary memory while any of the other preset program sets are active, so your edited data will be restored when you re-select the “user” set.

## Guitar/G1D Connection

Make sure that your G1D Divided Pickup Unit has been properly installed and connected to your guitar as described in the G1D Owner’s Manual before connecting it to the G50.

Make sure that the G50 Guitar MIDI Converter power is OFF, then plug one end of the multi-pin cable supplied with the G50 into the G1D multi-pin connector, and the other end into the DIVIDED INPUT connector on the G50.

When all connections have been properly made, turn the G50 power switch ON: the G1D power indicator should light indicating that it is receiving power from the G50.

■ **NOTES**

- For extra security and damage prevention it is a good idea to pass the cable between the strap and guitar body near the body strap pin.
- The multi-pin cable plug release button must be pressed when unplugging the multi-pin cable from the G50 or G1D.

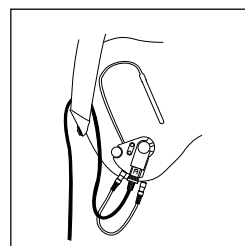
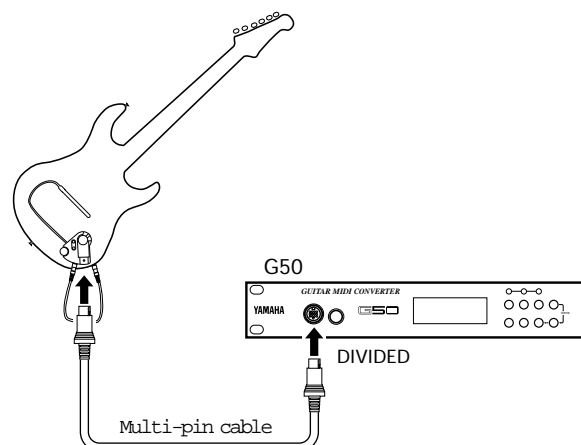

# Input Level Adjustment

Before actually playing your MIDI guitar it might be a good idea to adjust the G50 input gain for each string. This will ensure optimum sensitivity so that picking nuances will not be lost, while at the same time avoiding wrong pitch detection. You may have to re-adjust the input levels if you change the string height on your guitar, or switch to a different type of strings.

## ■ NOTES

- The normal guitar sound received via either the G1D or MONO SYNTH JACK is not affected by the input level settings.

### 1. Engage the Input Level Adjustment Mode

Press the [INPUT LEVEL] button. The indicator above the [INPUT LEVEL] button will light.

### 2. Play a Single String

Play a single string on the guitar at the loudest level you will actually be playing it. The number of the string played will appear on the left side of the display (“1” for the high E string through “6” for the low E string) and a number corresponding to the detected level will appear on the right of the display while the string is being played. The level values range from “1” (minimum) to “100” (maximum).

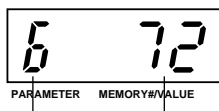

String number      Input level value

The ideal input level setting should produce an “oLd” display only on the slightly louder notes.

When if the sound can be heard as double notes, you have to readjust the input level to lower.

## ■ NOTES

- No string number will appear when the G50 is being used in the monophonic mode, and any gain settings made (as described in the next step) will apply to all strings.
- The [▲] and [▼] buttons can be used to select different string numbers when there is no input from the guitar.

### 3 Adjust the Input Gain

When the string stops playing, or when the [-1] or [+1] button is pressed, the current input gain setting for that string will appear in place of the detected peak input gain. The gain setting is preceded by a “G”, and ranges from “G1” (minimum gain) through “G50” (maximum gain). If necessary adjust the input gain via the [-1] and [+1] buttons until the optimum input gain is achieved.

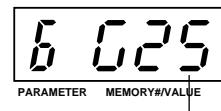

Input gain

### 4 Repeat for All Strings

Repeat steps 2 and 3 for all strings, then check the balance between the strings and re-adjust if necessary.

## ■ NOTES

- If you are using an MU-80 or MU-50 sound module, the multiple level meters on its display can be used as a handy level guide (set the “Velocity” parameter to “Wide” see page 14)

### 5 Return to the PLAY Mode

Press the [PLAY] button to return to the PLAY mode when the input gain for all six strings has been properly adjusted.

# Tuning

The G50's built-in tuner makes it easy to precisely tune your guitar — even in a noisy environment.

## 1 Engage the Tuner Mode

Press the [TUNER] button. The red indicator above the [TUNER] button will light and the current base tuning pitch will appear on the display: normally “A 440”. Although standard “concert pitch” is A = 440 Hz, the base pitch can be set anywhere from 440 to 445 hertz in 1-hertz steps at this point by using the [-1] and [+1] buttons.

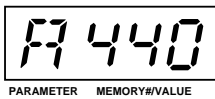

### ■ NOTES

- Tuning pitch is remained in the memory even if power is turned off. Tuning data is transmitted via the MIDI OUT terminal when power is turned on or the Tuning pitch is changed.

## 2 Play a Single String

Play the first string you want to tune. The closest note to the current pitch of the string played will appear on the display: “A” through “G#” (a “#” is indicated by the small “o” to the upper right of the note name). When the detected pitch is close to that of the standard tuning for the guitar string, the string number will also appear on the left of the display: e.g. “5 A” for the 5th string on a guitar, normally tuned to “A”.

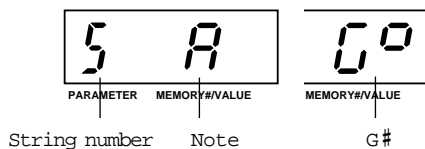

### ■ NOTES

- The string numbers for guitar are: 6E, 5A, 4d, 3G, 2b, and 1E.
- The string numbers for bass are: 6B, 5E, 4A, 3D, 2G, and 1c. The “extra” string numbers (6B and 1c) apply to 5-string and 6-string basses.

## 3 Tune the String

Tune the string while watching the display and the three indicators above the [TUNER] button (the latter indicate precise tuning in the TUNER mode). Tune so that the current sting number and note name appears on the display, and so that all three indicators above the [TUNER] button light simultaneously.

- - ● - ○ No input.
- - ● - ○ Flat (pitch too low).
- - ● - ● Sharp (pitch too high).
- - ● - ● Perfect tuning (within  $\pm 3$  cents).

## 4 Repeat for All Strings

Repeat steps 2 and 3 for all strings.

## 5 Return to the PLAY Mode

Press the [PLAY] button to return to the PLAY mode when all six strings have been precisely tuned.

# Play Mode

Any of the G50's 128 "programs" can be selected and played in the PLAY mode. Each program includes a range of settings which determine, for example, how the G50 responds to notes you play on the guitar, which voice is selected on your tone generator, split modes, and more. The actual settings for each program can be individually edited by you via the EDIT mode, described in the following section.

If you want to start playing right away, before editing any of the programs, you will be using the default settings (listed with each parameter in the "Edit Mode" section,

beginning on page 22). With the default settings each G50 program selects the correspondingly numbered voice on the tone generator. The default settings are designed to provide basic playability with most tone generators, but they may not be ideal for your particular system. You may have to do a little editing to get the best sound and response. You will definitely have to read the "Edit Mode" section and do a little editing if you want to use many of the G50's advanced features ... such as string or position based voice splitting.

## Selecting Programs & Playing In the PLAY Mode

### 1 Check Your G1D Settings

Make sure your guitar's volume control and the G1D volume control are set appropriately (the G1D volume control affects only the synthesized sound), and that the G1D GUITAR/MIX/SYNTH selector is set to the desired position:

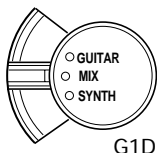

#### ● GUITAR

Only the direct guitar sound will be sent to the G50 (i.e. no synthesizer sound will be produced).

#### ● MIX

Both the direct guitar sound and individual-string synthesizer output are sent to the G50.

#### ● SYNTH

Only the individual-string synthesizer output is sent to the G50 (no direct guitar sound will be heard).

Refer to your G1D Owner's Manual for details.

### 2 Make sure the PLAY Mode is Engaged

The PLAY mode is automatically selected whenever the G50 power is turned on. If another mode is currently engaged, press the [PLAY] button to return to the PLAY mode. The number of the last program selected will appear on the display.

### 3 Select a Program

You can select any of the G50's 128 programs via either the G50 [-1] and [+1] buttons or the [DOWN] and [UP] buttons on the G1D Divided Pickup Unit. Press either button briefly to select the next program number in the corresponding direction ([+1] or [UP] to increment; [-1] or [DOWN] to decrement), or hold either button for continuous scrolling in the corresponding direction. When using the G50 panel buttons it is also possible to skip in tens (e.g. "010" → "020" → "030" → etc. or the reverse) by pressing the opposite button while holding the button corresponding to the direction in which you want to increment/decrement.

#### ■ NOTES

- The G1D [UP] and [DOWN] buttons can also be set to directly transmit MIDI program change numbers, or shift pitch up or down in octave steps. See "G1D [UP]/[DOWN] Button Functions", below.

### 4 Play

Assuming that everything is set up properly you should now be able to play the selected program and voice. Try selecting and playing different voices to get a feel for how they respond when played via the G50.

#### ■ NOTES

- The LED indicator above the [INPUT] button acts as an input indicator in the PLAY mode, flashing whenever a signal is detected from any of the guitar's strings.

## G1D [UP]/[DOWN] Button Modes

As described above, the G1D [DOWN] and [UP] buttons normally function in the same way as the G50 panel [-1] and [+1] buttons. This, however, is actually just one of three possible G1D [UP]/[DOWN] button modes.

### Memory/Value Mode ("dE")



The normal G1D [UP]/[DOWN] button mode in which the [DOWN] and [UP] buttons function in the same way as the G50 panel [-1] and [+1] buttons.

### Program Change Mode ("PG")



In this mode the G1D [DOWN] and [UP] buttons cause the G50 to transmit a program change number to the connected tone generator, without actually changing the G50 program. The [DOWN] and [UP] buttons decrement and increment the program change number, respectively. In this mode the number shown on the G50 display is the current program change number, not the number of the selected G50 program (the G50 program does not change).

### Octave Shift Mode ("oc")



In this mode the G1D [DOWN] and [UP] buttons shift the pitch of the synthesized sound down or up in octave steps by a maximum of two octaves. When this mode is selected the G50 display shows the current octave: "-2oc" (down two

octaves), "-1oc" (down one octave), "0oc" (no octave shift), "1oc" (up one octave), and "2oc" (up two octaves).

- The Octave Shift mode display is not affected by the setting of the "F: Transpose" parameter .

To change the G1D [UP]/[DOWN] button mode first make sure the G50 is in the PLAY mode, then use the G50 panel [-1] and [+1] buttons to select the desired mode while simultaneously holding the G1D [DOWN] and [UP] buttons: "dE" for the Memory/Value mode, "PG" for the Program Change mode, or "oc" for the Octave Shift mode. The abbreviation for the current mode appears on the G50 display when the G1D [DOWN] and [UP] buttons are pressed simultaneously.

### In the "PLAY" mode

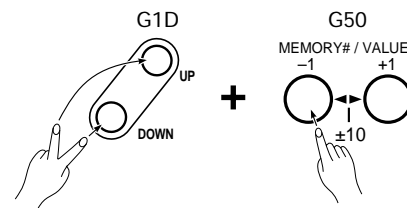

## Playing In the Monophonic Mode

If you do not have a G1D Divided Pickup Unit installed on your guitar, it is still possible to use the G50 in the monophonic mode, although some features will not be available.

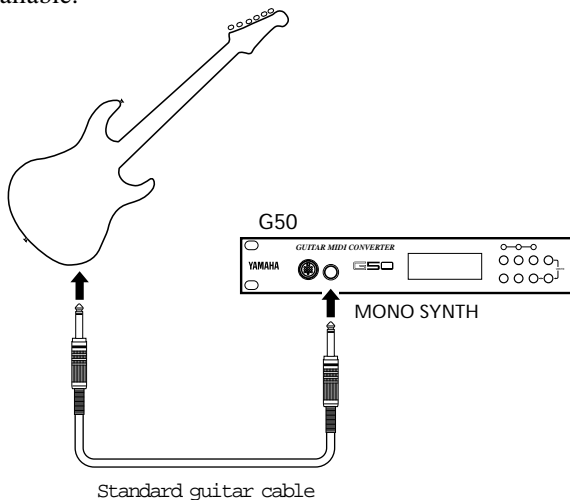

To use the monophonic mode, unplug the multi-pin cable from the G50 DIVIDED input, and connect a standard guitar cable from your guitar's output jack to the G50 MONO SYNTH input jack.

- The limitations that apply in the monophonic mode are as follows:
  - Only one note can be played at a time.
  - Input gain settings cannot be made for each individual strings — only all strings at once.
  - No string number appears on the display when the TUNER function is used.
  - Neither of the split functions or picking position parameters are available.

All other operations are the same as described elsewhere in this owner's manual.

# Edit Mode

The EDIT mode lets you set up each of the G50's programs for the response and playing features you require. The EDIT mode includes 25 parameters, each identified by a letter of the alphabet from "A" to "Y". The parameters are divided into three groups according to function:

- Guitar Setup (parameters "A" through "G")
- External TG Setup (parameters "H" through "P")
- Realtime Control (parameters "Q" through "Y")

The parameters are accessed and edited as follows:

## ■ Edit and Write Operation

### 1 Select a Parameter.

From the PLAY mode, use the [▲] and [▼] buttons to engage the EDIT mode and select the desired parameter. The letter corresponding to the currently selected parameter appears on the left side of the display while the parameter's current value/setting appears on the right side of the display. Press either button briefly to select the next parameter in the corresponding direction ([▼] to select the next parameter toward "Y", or [▲] to select the next parameter toward "A"), or hold either button for continuous scrolling in the corresponding direction.

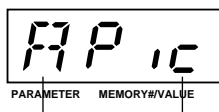

Parameter letter      Setting

### 2 Edit the Parameter as Required

After selecting the desired parameter, use the [-1] and [+1] buttons to set the parameter to the required value. Continue selecting parameters and editing until the entire program is set up the way you want it

### 3 Return to the PLAY Mode

Press the [PLAY] button to return to the PLAY mode.

### 4 Write (save) the Edited Program

Once you have edited a program and returned to the PLAY mode, the program must be saved to memory if you want to keep the edited before you select a different program. If you select a different program without saving the edited data, the edited data will be lost and the previous version of that program will be restored. The save procedure is as follows:

1. To save the edited program, first press the [+1] button while holding the [PLAY] button. The current program number will flash. If at least one parameter in the program has been edited, a small "e" will appear on the left side of the display.



2. At this point you can choose to save the edited data to a different program number by using the [-1] and [+1] buttons to select the destination program number.
3. Finally, press the [▼] ("YES") button again to actually store the data in the specified program number. Press [▲] ("NO") if you want to cancel the save operation at this point. If you choose to save, "don" (this stands for "done") will appear on the display briefly when the data has been saved, then the G50 will return to the PLAY mode with the destination program number selected.

## ■ NOTES

- Since you can save program data to a different program number using the above procedure, you can also copy the data from one program number to another location where it can then be edited as required.

## ■ The Memory Swap Function

In addition to the memory save function described above, the G50 also has a "Memory Swap" function which makes it possible to swap the contents of the current program with any other specified program.

### 1 Engage the Memory Swap Function

Press the [-1] button while holding the [PLAY] button. The current program number will flash and a small "s" will appear on the left side of the display.



### 2 Specify the Program to Swap With

Use the [-1] and [+1] buttons to select the number of the program you want to swap the current program with.

### 3 Swap the Programs

Press the [▼] ("YES") button to swap the data in the current and specified program number. Press [▲] ("NO") if you want to cancel the swap operation at this point. If you choose to swap, "don" (this stands for "done") will appear on the display briefly when the data has been saved, then the G50 will return to the PLAY mode.



## Guitar Setup

The “Guitar Setup” parameters (“A” through “G”) determine how the G50 responds to what you play on the guitar. These settings are important for achieving optimum response with your own instrument and playing style.



**A: Playing Style**  
Settings: Pic, Fin (or Pic, SLP for bass), —

Set according to the playing style you intend to use: “Pic” for normal pick-style playing, or “Fin” for finger-picking guitar styles. When using a bass pickup you can select either “Pic” for normal pick-style or finger-style playing, or “SLP” for slap styles. You may have to experiment with different settings to achieve optimum sensitivity, depending on the type of guitar you use. If the G50 is being used in the monophonic mode, “—” appears on the display and this parameter is not available.



**B: Note On Level**  
Settings: 1 ... 10

Sets the note-on trigger level of the G50 — i.e. how loud a note must be played on the guitar before it triggers the corresponding note on the G50. The range is from 1 to 10, with lower values corresponding to lower trigger levels (i.e. higher sensitivity). In other words, low values allow softer notes played on the guitar to trigger the G50. If the setting is too low, however, the G50 may be triggered by noise from the guitar. The ideal setting will depend on your guitar’s pickup, noise levels, and the G50 input level settings. It may be necessary to readjust the Note On Level setting if you change the G50 input level settings.

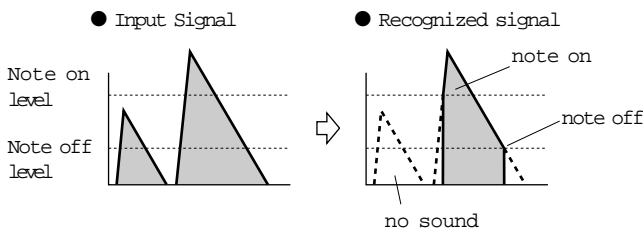

**C: Note Off Level**  
Settings: 1 ... 10

Sets the note-off level of the G50 — i.e. the level at which a triggered note stops playing as the guitar note decays. The range is from 1 to 10, with lower values corresponding to lower note-off levels. Set this parameter carefully to match your instrument and playing style: if set at too high a value, notes may cut off unnaturally, while too low a setting may result in notes playing

continuously. The ideal setting will depend on your guitar’s pickup, noise levels, and the G50 input level settings. It may be necessary to readjust the Note Off Level setting if you change the G50 input level settings.



**D: Velocity**  
Settings: Nar, Nor, uui, 1 ... 127

Specifies the dynamic range of notes produced by the G50 — i.e. the range from the softest to loudest notes produced.

- “Nar” sets a narrow dynamic range.
- “Nor” is the normal setting, setting the normal dynamic range.
- “uui” (this represents “w”) produces the widest dynamic range.

A value between “1” and “127” produces fixed velocity (volume) at the specified velocity value. The higher the value, the louder the notes.



**E: Chromatic**  
Settings: off, on, Au

The G50 converts slides and string bends to the corresponding MIDI pitch bend data which is then transmitted to the connected tone generator. This parameter determines whether the bend data is transmitted at full resolution (smooth bends), or in chromatic semitone steps for glissando type effects.

When “off” pitch bend data is transmitted at full resolution over the range specified by the Pitch Bend Range parameter (parameter “G”, below).

When “on” pitch bend data is transmitted in chromatic semitone steps.

When “Au” is selected the “on” and “off” modes are switched automatically according to whether a chord (chromatic “on”) or single-note line (chromatic “off”) is being played.

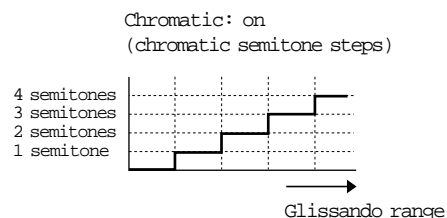

**F: Transpose**  
Settings: -24 ... 0 ... 24

Transposes the pitch of notes played up or down in semitone steps over a  $\pm 2$ -octave range. The range is from “-24” (down 2 octaves) through “0” (no transposition) to “24” (up 2 octaves).



G: Pitch Bend Range  
Settings: 0 ... 24

Sets the maximum range of pitch bend data generated by the G50. The minimum setting of “0” produces no pitch bend data, while the maximum setting of “24” allows the G50 to produce pitch bend data over a 2-octave range. Each step corresponds to a semitone: a setting of “4” produces a pitch bend range corresponding to an interval of a third, a setting of “7” produces a pitch bend range corresponding to an interval of a fifth, etc. When set to

“0”, bending a string or using the whammy bar will produce sudden semitone jumps when the pitch of the string(s) reaches that of the next note. A setting of “1” is similar to “0”, but allows a small bend range which is suitable for vibrato.

■ NOTES

- Whenever this setting is changed the selected pitch bend range setting is transmitted via MIDI OUT.
- If your tone generator does not recognize MIDI pitch bend range messages, set the tone generator’s own pitch bend range parameter as required.

### Tone Generator Setup

The “Tone Generator Setup” parameters specify a range of MIDI messages to be transmitted when the current G50 program is selected: e.g. which tone generator voice is selected, as well as any MIDI volume, pan, or controller settings you might want to transmit for the selected voice. The corresponding MIDI message is also transmitted when any of these parameters are edited.



H: Program Number  
Settings: off, 1 ... 128

Specifies the MIDI program number to be transmitted when the current G50 program is selected. If, for example, you want the current G50 program to select, say, voice (or “patch”) number 57 on your synthesizer/tone generator, set this parameter to “57”.

Turn this parameter “off” if you don’t want any MIDI data to be transmitted by the current G50 program. The “off” setting also makes it possible to automatically switch between the direct guitar sound and the mixed guitar/synthesized sound when using one of the split functions described in the “Real Time Control” section, below (i.e. turn the “H: Program Number” parameter “off” for one of the programs used in the split setup, so that only the direct guitar sound is produced by that program).

(Least Significant Byte). Both the Program Bank MSB and LSB can be set from “0” to “127”, or turned “off” if no bank number is to be transmitted. Since the bank number is always transmitted with a program change number, “---” appears on the display and the Program Bank MSB/LSB parameters are not available when the H: Program Number parameter is turned “off”.



K: Volume  
Settings: off, 0 ... 127

Sets the Master Volume level of the receiving tone generator. This parameter is an ideal way to individually set the volume level of each voice selected by the G50 for optimum “balance” in your application: e.g. so that there are no unnatural volume changes when switching between voices, or so that the volume of the selected voice is just right for the backing with which it will be used, etc. The “K: Volume” parameter also specifies the maximum volume setting which can be received from the G1D Divided Pickup volume control or an external MIDI controller such as the Yamaha MFC10 MIDI Foot Controller.

The Volume range is from “0” (minimum volume) to “127” (maximum volume). This parameter can also be turned “off” if you want no volume data to be transmitted.



I: Bank MSB  
Settings: off, 0 ... 127, —



J: Bank LSB  
Settings: off, 0 ... 127, —

These two parameters set the program change bank number for tone generators which have more than 128 voices with bank selection. The bank number is made up of two parts: a MSB (Most Significant Byte) and an LSB



L: Pan  
Settings: off, L15 ... C ... R15

Sends a MIDI panpot message which sets the stereo pan position of the corresponding tone generator voice. The range is from “L15” (full left) through “C” (center) to “R15” (full right). No panpot data is transmitted when this parameter is turned “off” (although a “center” panpot message is sent the instant that this parameter is actually set to “off”).



M: Assignable Control Number 1  
Settings: off, 1 ... 31, 33 ... 120, AF



N: Assignable Control Value 1  
Settings: 0 ... 127, —



O: Assignable Control Number 2  
Settings: off, 1 ... 31, 33 ... 120, AF



P: Assignable Control Value 2  
Settings: 0 ... 127, —

These parameters specify one or two MIDI control change numbers with corresponding values to be transmitted when the current G50 program is selected. MIDI control change numbers generally correspond to “controller” functions such as modulation, sustain pedal, expression, breath control, etc. Some of the control numbers are already assigned according to the MIDI specifications (refer to the owner’s manual of the receiving devices for

details on “MIDI Control Change Numbers”), but many are unassigned and can sometimes be assigned to voice or effect parameters via the synthesizer or tone generator. The Assignable Control Number 1 and 2 parameters (“M” and “O”) specify the control number(s) to be transmitted. The range is from “1” through “31”, “33” through “120”, or “AF” for After Touch. The Assignable Control Value 1 and 2 parameters (“N” and “P”) specify the control change value to be sent with the corresponding control change number: “N: Assignable Control Value 1” specifies the control change value for “M: Assignable Control Number 1”, and “P: Assignable Control Value 2” specifies the control change value for “O: Assignable Control Number 2”. The control value range is from “0” to “127”. “---” will appear on the display and the parameter will be unavailable if the corresponding Assignable Control Number parameter is turned “off”.

## Real Time Control

The “Real Time Control” group includes a range of parameters that enable and define the operation of several advanced real-time performance features.



Q: Split  
Settings: off, Sr1 ... Sr5, P1 ... P10

The G50 has two “split” modes which allow two different programs to be played at the same time.

### ● String Split

In this mode the two programs are played on different groups of strings. For example, you could play acoustic bass on the two lowest strings (5 and 6) while playing organ on the remaining four strings (1 through 4).

- The String Split settings are “Sr1” through “Sr5”. The number represents the string at which the split occurs. With the “Sr1” setting, the split occurs between the 1st string (high E) and the lower 5 strings (2 through 6). With the “Sr5” setting the split occurs between strings 1 through 5 and string 6. Intermediate settings produce a split between the corresponding string groups.

### ● Picking Position Split

In the Picking Position Split mode the split is “horizontal” rather than “vertical” as in the String Split mode. In other words, one program is played on the neck side of a certain point on the string, while the second program is played on the bridge side of the “split” position. The appropriate program change number is transmitted whenever the split point is crossed.

- The Picking Position Split settings are “P1” through “P10”. Lower values move the split position toward the bridge and higher settings move the split position toward the neck. Experiment with the settings to find the ideal split position.

In the split modes the first program is the currently selected program. The second program is specified by the “R: Split Memory 2 Number” parameter, below. No split occurs when this parameter is set to “off”. If the G50 is being used in the monophonic mode, “---” appears on the display and this parameter is not available. Also, the “P1” through “P10” settings are not available when the “A: Playing Style” parameter is set to “Fin” for guitar or “SLP” for bass (“---” will appear on the display).



R: Split Memory 2 Number  
Settings: 1 ... 128, —

This parameter specifies the second program to be played in the String Split or Picking Position Split mode (see “Q: Split”, above). The “S: Memory Location” parameter, below, determines which side of the “split” the second program is assigned to.

The settings are “1” through “128”, corresponding to the desired second program number. When the “Q: Split” parameter is set to “off” (i.e. no split mode is selected), “---” appears on the display and this parameter is not available.



**S: Memory Location**  
 Settings: Lo, Hi, —

This parameter determines whether the second split-mode program (specified by the “R: Split Memory 2 Number” parameter, above) is played on the lower or upper string group when the String Split mode is selected, or on the neck or bridge side of the split position when the Picking Position Split mode is selected.

When set to “Lo”, the second program is played on the lower-pitched string group in the String Split mode, or on the nut side of the split position in the Picking Position Split mode.

When set to “Hi”, the second program is played on the higher-pitched string group in the String Split mode, or on the bridge side of the split position in the Picking Position Split mode.

When the “Q: Split” parameter is set to “off” (i.e. no split mode is selected), “---” appears on the display and this parameter is not available.

● String split

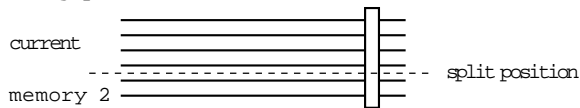

● Picking position split

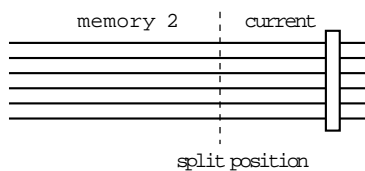

**T: Picking Position Control**  
 Settings: off, 1 ... 31, 33 ... 120, AF, —



**U: Picking Front Position Value**  
 Settings: 0 ... 127, —



**V: Picking Rear Position Value**  
 Settings: 0 ... 127, —

The “T: Picking Position Control” parameter specifies the control change number to be transmitted when the guitar is played. The range is from “1” through “31”, “33” through “120”, or “AF” for After Touch. No picking position control change message will be transmitted when this parameter is turned “off”.

The “U: Picking Front Position Value” and “V: Picking Rear Position Value” parameters specify the control

change value to be sent: “U: Picking Front Position Value” specifies the control change value for the nut side of the split position”, and “V: Picking Rear Position Value” specifies the control change value for the bridge side of the split position. The control value range is from “0” to “127”. “---” will appear on the display and the parameter will be unavailable if the “T: Picking Position Control” parameter is turned “off”.

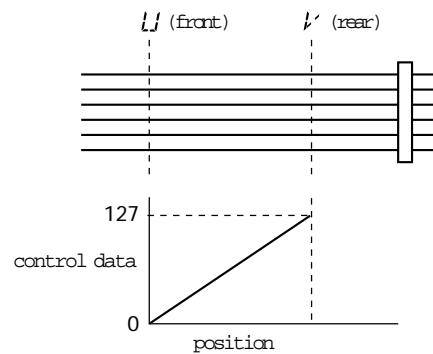

**W: Touch Control**  
 Settings: off, 1 ... 31, 33 ... 120, AF



**X: Sensitivity**  
 Settings: -7 ... 0 ... 7, —

The G50 is capable of detecting the amplitude envelope of the guitar output and converting this to MIDI control change data which can be used to produce interesting variations in the synthesized sound. You could, for example, have the guitar envelope control a filter cutoff frequency to create a “sweep” effect.

The “W: Touch Control” parameter specifies the control change message to be transmitted in correspondence with the guitar envelope. The range is from “1” through “31”, “33” through “120”, or “AF” for After Touch. No touch control change message will be transmitted when this parameter is turned “off”.

The “X: Sensitivity” parameter sets the G50’s sensitivity to the guitar envelope. Higher positive values increase the sensitivity, and therefore the “range” of the converted control change data. Negative values produce a corresponding inverted envelope. If the “W: Touch Control” parameter is turned “off”, “---” appears on the display and this parameter is not available.

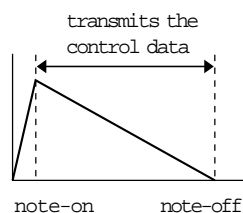

● Settings  
0 - 7

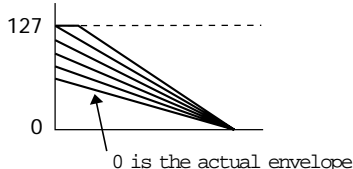

● Settings  
"-1" through  
"-7"

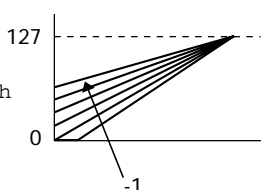

■ NOTES

- When using either "T: Picking Position Control" or "W: Touch Control" to control a MIDI NRPN function, set the appropriate NRPN MSB and LSB via the Assignable Control Number 1 and 2 parameters (page 16) then set the data entry MSB via the "T: Picking Position Control" or "W: Touch Control" parameter.



Y: Sustain/Hold Pedal

Settings: SU1, SU2, 1 ... 128

An optional Yamaha FC4 or FC5 footswitch can be connected to the rear-panel SUSTAIN/HOLD jack for sustain or hold function control, as described below.

When either the "SU1" or "SU2" is selected, the footswitch functions as a sustain pedal.

● SU1

The SUSTAIN 1 mode: the pedal functions like the sustain pedal on a piano, sustaining notes played until the pedal is released. In this mode new notes can be played while the pedal is held.

● SU2

The SUSTAIN 2 mode: played notes are sustained while the pedal is held, and pitch bend/vibrato data will be recognized. Subsequent notes played on the same string will not be recognized while the pedal is held. Other strings are processed in the normal way. Long tones can be played with string bends or vibrato without the need for additional note-on data.

Selecting a number between 1 and 128 engages the HOLD 1 or HOLD 2 mode. The hold modes can be switched by turning the G50 power ON while pressing the footswitch. When this is done the current hold mode type will appear on the display briefly before the normal PLAY mode display: "HLd1" for the HOLD 1 mode, or "HLd2" for the HOLD 2 mode.

● Hld1

The HOLD 1 mode: the parameter value (1 ... 128) corresponds to a G50 program number. If the pedal is pressed while a note is played, the note is held and the G50 switches to the program number specified by the SUSTAIN/HOLD parameter value. New notes played while the pedal is pressed are played via the hold program. All sound is muted when the pedal is released.

● Hld2

The HOLD 2 mode: the pedal toggles between the current G50 program and the program specified by the SUSTAIN/HOLD parameter value. "Hld" appears on the display while the hold program is selected.

■ NOTES

- The HOLD function uses one MIDI channel, as listed in the "Multi-channel Mode Settings" chart on page 7.
- Choose a non-decaying voice (such as ORGAN) when using the SUS1, SUS2, or HLD1 function.
- MIDI sustain ON/OFF data can be received while the sustain or hold function is active.

---

## MIDI Bulk Dump Transmission & Reception

Editing all 128 of the G50's programs can involve a fair amount of time and effort. The MIDI Bulk Dump feature makes it possible to save single programs or all programs to an external MIDI data recorder such as the Yamaha MDF2 or a sequencer with MIDI data recorder capability. Another use for this feature is to create different sets of programs for different applications. You can create a library of G50 programs to cover all your needs.

### ■ MIDI Bulk Dump Transmission

- 1 Press [MIDI] While Holding [PLAY]

To transmit the program data from the G50 to an external device, first press the [MIDI] button while holding the [PLAY] button. A small "b" will appear to the left of the program number, and the entire display will flash.



00 1 - 128, ALL

- 2 Specify a Program Number or "ALL"

Use the [-1] and [+1] buttons to select a single program to transmit ("1" through "128"), or select "ALL" to transmit all 128 programs.

- 3 Transmit the Data

Press the [▼] ("YES") button to begin the actual bulk dump transmission, or [▲] ("NO") to cancel. If you start the transmission, "Snd" will appear on the display while the data is being transmitted, then "don" will appear briefly when the transmission is done.

### ■ MIDI Bulk Dump Reception

Program data can be reloaded from an external storage device while the G50 is in the PLAY mode. The data is loaded automatically when received from the external storage device.

A single program will be loaded into the currently selected G50 program number, replacing the previous program. If all programs are received, all 128 of the G50's programs will be replaced.

"rEc" will appear on the G50 display during MIDI bulk dump reception, then "don" will appear when the data has been successfully received. If an error is encountered during reception, "MErr" will appear on the display and the receive operation will be aborted. The "don" or "MErr" message will disappear when any mode button is pressed.

# Initialize

The Initialize operation resets all of the G50's internal settings to their original factory settings. By initializing the G50, the Preset Program Memory U (User) type is reset to the factory settings. The tuning pitch is reset to 440.

## ■ CAUTION

- All Program Data will be erased (overwrite) if the initialize operation is carried out. All important data should be saved to an external MIDI device with the MIDI Bulk Dump operation.

1. While holding both the [PLAY] and [+1] buttons, switch the [POWER] ON.  
Continue to hold both buttons until "FAC" appears in the display.

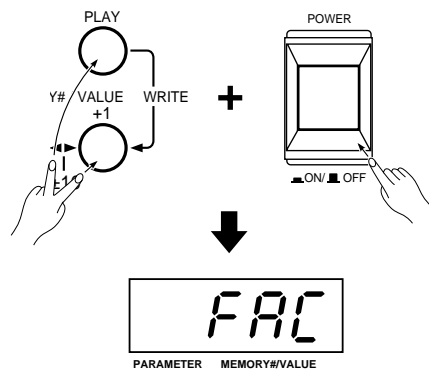

2. Press the [▼] ("YES") button to execute the initialize operation.  
"ini" will appear in the display after the operation is finished, and the G50 will return to the play mode.  
Memory number "001" will be automatically selected.

To cancel the initialize operation, press the [PLAY] button. The operation will be aborted and the G50 will return to the play mode.

## ■ Specifications

### ● Main Functions

Memory: 128

#### Guitar Setup

Playing Style, Note On Level, Note Off Level, Velocity, Chromatic, Transpose, Pitch Bend Range

#### External Tone Generator Setup

Program Number, Program Bank MSB, LSB, Volume, Pan, Assignable Control Number 1, 2, Assignable Control Value 1, 2

#### Real-time Control

Split, Split Memory 2 Number, Memory Location, Picking Position Control, Picking Front Position Value, Picking Rear Position Value, Touch Control, Sensitivity, Sustain/Hold Pedal

#### System Setup

Input Gain, MIDI Channel

#### Other

GLD Up/Down Button Function Settings (Data Entry, Program Number, Octave Shift) Chromatic Tuner (Tuning Pitch) Memory Save (Write), Memory Swap, Preset Program Type (User, MU80/MU50, VL70-m, VL 1-m Version 2), MIDI Bulk Receive and Transmit

### ● Operation

Single digit union jack LED, 3 digit 7 segment LED, Mode LED (Green x2, Red x1), Panel Switch x8, Power Switch, Guitar/Bass Selector Switch

### ● Connections

DIVIDED Input Jack, MONO SYNTH Input Jack, GUITAR DIRECT OUT Jack, MIDI IN/OUT Jack, SUSTAIN/HOLD Jack (Footswitch: sold separately), DC-IN Jack

### ● Power Supply

PA-3B AC adaptor (or another Yamaha -recommended adaptor)

### ● Accessory

13 Pin Cable: 7 m

### ● Dimensions (W x D x H)

482.6 x 201.8 x 44.0 mm (19" x 8" x 1-3/4")

### ● Weight

2.2 kg (4 lbs., 14 oz.)

\* Specifications subject to change without notice.

# Troubleshooting

If you think there is a problem with your G 50, first check the information below for a possible solution. If that does not solve the problem, contact the nearest Yamaha dealer or the music store where you purchased the G 50.

The instrument (guitar) produces no sound.

- Is everything properly connected? (see page 6)
- Is the AC adaptor properly connected?

The synth produces no sound.

- Is the G1D VOL (Volume) properly adjusted?
- Is the tone generator or sound system's volume properly adjusted?
- Is the K: Volume setting set to 0? (see page 15)

Can not hear the guitar's normal sound.

- Is the guitar's volume properly adjusted?
- Is the guitar amp's volume properly adjusted?
- Is the G1D's normal guitar cable properly connected?

There is some noise in the sound.

- Is the G1D's normal guitar cable properly connected?

Some strings sound yet others do not.

- Check the input gain for each string.(see page 9)

Playing softly does not produce any sound.

- Is the NOTE ON LEVEL setting too high or input gain setting properly adjusted? (see pages 14, 9)

The sound is suddenly cut off.

- Is the NOTE OFF LEVEL setting too high? (see page 14)

The sound does not cut off.

- Is the Note Off Level setting too low? (see page 14)
- Is the Input Gain setting too high? (see page 9)

When you use a double choking technique, only one choke is heard.

- Is the MIDI Channel set to the Single-channel Polyphonic Mode or Monophonic Mode? (see page 7)

The pitch is not stable when playing with a choke technique.

- Adjust the G: Pitch Bend Range. (see page 15)

Can not select the Separate Mode.

- Use the 13-pin cable that is supplied with the G1D to connect the guitar to the unit.

Can not select the Mono Synth Mode.

- Use the MONO SYNTH jack to connect the guitar to the unit.
- Disconnect the cable from the guitar's DIVIDED jack.

Can not assign the parameter in the A: Playing Style, Q: Split, or T: Picking Position Control.

- These settings are invalid in the Monophonic mode. (see pages 14, 16, 17, 7)

The tone generator's settings have changed.

- When Type 2 or 3 in the Preset Program Type is selected, the appropriate bulk data is transmitted changing the tone generator's settings accordingly. (see page 8)

The foot pedal function does not work as expected.

- Adjust the settings for Y: Sustain/Hold Pedal. (see page 18)

"MErr" appears on the display.

- There is an abnormality in the internal data. The data was replaced by initializing the unit.

"SErr" appears on the display.

- There is an abnormality in the hardware. Switch the POWER off and take the unit to your nearest Yamaha Dealer or the music store where you purchased it for further evaluation or repair.

"BuFL" appears on the display.

- The MIDI Buffer is full, and the receive buffer has been cleared. Set a longer interval between transmitted blocks on the transmitting device.

"BALo" appears on the display.

- The Back-up Battery's power is low. Save all data to an external MIDI device as soon as possible, and take the unit to your nearest Yamaha Dealer or the music store to have the back-up battery replaced.



# Preset Program Lists / Verzeichnisse der Preset-

■ Guitar/Bass select switch: when "GUITAR" is selected / Wenn der GUITAR TYPE-Schalter auf



- Type: U (User / Anwender / utilisateur)
- When the initialize operation is executed, the data listed below will be loaded into the G50's internal memory.
- Nach einer Initialisierung werden die unten aufgeführten Daten in den Speicher des G50 geladen.
- Lorsque l'opération d'initialisation est réalisée, les données listées ci-dessous sont chargées dans la mémoire interne du G50.

MEM #	PGM	MSB	LSB	Voice name	Remarks
1	84	0	0	Chiff Lead	
2	82	0	0	Saw Lead	
3	36	0	0	Fretless	
4	39	0	0	Syn Bass	
5	115	0	0	Steel Drum	
6	49	0	0	Strings	
7	63	0	0	Syn Brass	
8	91	0	0	Poly Syn Pad	
9	2	0	0	Piano	
10	66	0	0	Alto Sax	
11	33	0	0	Aco Bass	
	25	0	0	Nylon Guitar	*1
12	28	0	0	Clean Guitar	
	29	0	0	Mute Guitar	*2
13	30	0	0	Overdrive	
	32	0	0	Guitar Harmonics	*2
14	34	0	0	Finger Bass	
	37	0	0	Slap Bass	*2
15	89	0	0	New Age Pad	
16	83	0	0	Calliope Lead	
17	86	0	0	Voice Lead	
18	12	0	0	Vibes	
19	100	0	0	Atmosphere	
20	17	0	0	Draw Organ	*3

- \*1 String Split (for finger picking)
- \*2 Picking Position Split
- \*3 Picking Position Control = Modulation
- \*1 Saiten-Split (zum Zupfen)
- \*2 Positions-Split
- \*3 PICKING CONTROL = Modulation
- \*1 Partage de corde (pour pincement avec les doigts)
- \*2 Partage de position de pincement
- \*3 Contrôle de position de pincement = Modulation



- Type: I
- When Preset Program Type "1" is selected, the data listed below will be loaded into the G50's memory.
- Beim Auswählen von Preset-Programmset "1" werden die unten aufgeführten Daten in den Speicher des G50 geladen.
- Lorsque le type de programme pré-réglé "1" est sélectionné, les données listées ci-dessous sont chargées dans la mémoire du G50.

MEM #	PGM	MSB	LSB	Voice name	Remarks
1	63	0	45	AnaVelBr	
2	85	0	65	WireLead	
3	34	0	65	ModALem	
4	39	0	64	Oscar	
5	115	0	0	SteelDrm	
6	50	0	0	Strings2	
7	64	0	40	SynBras4	
8	91	0	66	Ana Pad	
9	5	0	45	VX EL.P1	
10	66	0	43	HyprAlto	
11	33	0	0	Aco.Bass	
	25	0	0	NylonGtr	*1
12	28	0	0	CleanGtr	
	29	0	0	Mute.Gtr	*2
13	30	0	43	Gt.PinCh	*3
14	38	0	43	VeloSlap	*3
15	92	0	66	Itopia	
16	86	0	64	VoxLead	
17	91	0	65	Click Pad	
18	79	0	64	HrmoRain	
19	1	0	41	Dream	
20	17	0	32	DetDrwOr	*4
21	12	0	45	HardVibe	
22	99	0	69	DigiBell	
24	26	0	35	12StrGtr	
41	29	0	45	Jazz Man	
42	40	0	64	X WireBa	
43	41	0	0	Violin	
44	43	0	0	Cello	
56	56	0	64	Impact	
65	64	0	64	AnaBrss2	
105	89	0	64	Fantasy2	
106	102	0	64	GobSyn	
107	96	0	64	PolarPad	
108	105	0	0	Sitar	
109	106	0	0	Banjo	
110	109	0	0	Kalimba	
115	99	0	67	XmasBell	
128	17	127	0	Rock Kit	

- \*1 String Split (for finger picking)
- \*2 Picking Position Split
- \*3 The tone will change according to the amount of velocity.
- \*4 Picking Position Control = Modulation
- \*1 Saiten-Split (zum Zupfen)
- \*2 Positions-Split
- \*3 Der Ton ändert sich mit der Spieldynamik.
- \*4 PICKING CONTROL = Modulation
- \*1 Partage de corde (pour pincement avec les doigts)
- \*2 Partage de position de pincement
- \*3 La tonalité change selon l'importance de la vitesse.
- \*4 Contrôle de position de pincement = Modulation

# Programme / Liste des programmes préréglés

"GUITAR" gestellt ist / Sélecteur guitare/basse : quand "GUITAR" est sélectionné



- Type: 2
- When Preset Program Type "2" is selected, the data listed below will be loaded into the G50's memory. VL 70-m tone data (Cst001-006.Int001) will also be sent with the bulk.
- Beim Auswählen von Preset-Programmset "2" werden die unten aufgeführten Daten in den Speicher des G50 geladen. Zusammen mit den Bulk-Daten werden auch Sounddaten für den VL70-m übertragen (Cst001 bis Cst006, Int001).
- Lorsque le type de programme préréglé "2" est sélectionné, les données listées ci-dessous sont chargées dans la mémoire du G50. Les données de sonorités (Cst001-006.Int001) du VL70-m sont également envoyées en bloc.

MEM#	PGM	MSB	LSB	Voice name	Remarks
1	1	-	2	Shakuhac	*1
2	4	-	0	GuitHero	
3	2	-	2	TenorSax	*1
4	3	-	2	Birdland	
5	4	-	2	OldMini	
6	5	-	2	RockPigs	*2
7	1	-	2	Shakuhac	*1, 3
8	1	-	3	GuitHero	*4
9	6	-	2	Yhokih	
10	12	-	0	Igneous	
11	15	-	0	Wynth	
12	19	-	0	OsciLead	
13	20	-	0	SqrLead	
14	21	-	0	Bigger	
15	22	-	0	AnaSquid	
16	23	-	0	SharpSyn	
17	29	-	0	Fnground	
18	31	-	0	FlageoBs	
19	32	-	0	DampBass	
20	33	-	0	Fretles!	
21	35	-	0	ThumBass	
22	38	-	0	WarmBass	
23	40	-	0	Box Bass	
24	42	-	0	FruitBas	
25	44	-	0	SqrBass!	
26	45	-	0	PulsClav	
27	46	-	0	MogueBas	
28	47	-	0	BoppaBas	
29	48	-	0	BuzzrBas	
30	49	-	0	MuteHrBs	
31	51	-	0	TranzBas	
32	52	-	0	Chamlion	
33	53	-	0	ParaSynB	

- \*1 Touch Control = Breath Noise
- \*2 Picking Position Control=Modulation
- \*3 Picking Position Control=Embouchure
- \*4 Picking Position Control=Tonguing
- \*1 TOUCH CONTROL = Breath Noise
- \*2 PICKING CONTROL = Modulation
- \*3 PICKING CONTROL = Embouchure
- \*4 PICKING CONTROL = Tonguing
- \*1 Contrôle de toucher = Bruit de souffle
- \*2 Contrôle de position de pincement = Modulation
- \*3 Contrôle de position de pincement = Embouchure
- \*4 Contrôle de position de pincement = Tongueing

MEM#	PGM	MSB	LSB	Voice name	Remarks
34	54	-	0	SteamBas	
35	55	-	0	BooBass	
36	57	-	0	AtackSyn	
37	60	-	0	India	
38	61	-	0	YamSteel	
39	63	-	0	M u	
40	65	-	0	DinoPerc	
41	66	-	0	Formula	
42	67	-	0	Jurassic	
43	69	-	0	SpcHorse	
44	71	-	0	Suedhead	
45	74	-	0	JazzyGtr	
46	75	-	0	L7 Pluck	
47	80	-	0	Carlos	
48	81	-	0	Destiny	
49	83	-	0	Grunge	
50	84	-	0	Ossyncro	
51	85	-	0	Talk Box	
52	86	-	0	SyncLead	
53	87	-	0	Old Mini	
54	88	-	0	Fat Mini	
55	89	-	0	Parlapho	
56	90	-	0	SimpleSy	
57	91	-	0	Chronic	
58	92	-	0	SlitMinu	
59	94	-	0	Flaggoot	
60	95	-	0	SynSkex	
61	98	-	0	FlatLead	
62	99	-	0	PhilTur	
63	100	-	0	ChalPuls	
64	101	-	0	Pluck Id	
65	102	-	0	Brassyn	
66	103	-	0	AcoSynLd	
67	104	-	0	Moby	
68	106	-	0	LyricOff	
69	107	-	0	Rezzawi	
70	108	-	0	Macro	
71	109	-	0	Claribo	
72	110	-	0	Binaphon	
73	113	-	0	Persinet	
74	114	-	0	PicoPipe	
75	115	-	0	Gertrude	
76	116	-	0	Xynth	
77	121	-	0	Electrum	
78	122	-	0	Edgeopho	
79	123	-	0	BassCla!	
80	124	-	0	WX Clari	
81	125	-	0	WX Oboe	
82	127	-	0	Shakuha!	
83	128	-	0	LipClari	
84	1	-	1	Vento	
85	3	-	1	Sintax	
86	7	-	1	LiteAlto	
87	8	-	1	Trmbone!	
88	10	-	1	Air Sax	
89	11	-	1	TenrSax!	
90	12	-	1	Coca	
91	14	-	1	Viol Inn	
92	16	-	1	BrethBow	
93	17	-	1	Trumpt!2	
94	22	-	1	Flumpet	
95	23	-	1	WXTrumpt	
96	26	-	1	Melwbone	
97	27	-	1	NerzoBr	
98	30	-	1	NuHorne	
99	31	-	1	WX Horn	
100	43	-	1	DoublBow	
101	48	-	1	C Flute2	
102	50	-	1	OakFlute	
103	52	-	1	RzdeFlt	
104	54	-	1	Nz Flute	
105	58	-	1	Bamboo	

MEM #	PGM	MSB	LSB	Voice name	Remarks
106	60	-	1	Flurinet	
107	62	-	1	Flurmod	
108	66	-	1	NuSopSax	
109	68	-	1	SoprPipe	
110	70	-	1	AnaSoprn	
111	71	-	1	NuAltSax	
112	77	-	1	AcidSax	
113	83	-	1	BellMike	
114	90	-	1	Oboe!	
115	98	-	1	Bassoon!	
116	111	-	1	Lonely	
117	114	-	1	MizuHorn	
118	117	-	1	BowLead	
119	119	-	1	MouthKey	
120	120	-	1	AmpdHarp	
121	121	-	1	CromHarp	
122	122	-	1	WahUpHp	
123	123	-	1	YamaBotl	
124	124	-	1	Blowsoo	
125	125	-	1	Brappo	
126	126	-	1	Crumbon	
127	127	-	1	Klarina	
128	128	-	1	ReedWin	



- Type: 3
- When Preset Program Type “3” is selected, the data listed below will be loaded into the G50’s memory. VL 1-m Version 2 tone data (A01-A06) will also be sent with the bulk.
- Beim Auswählen von Preset-Programmset “3” werden die unten aufgeführten Daten in den Speicher des G50 geladen. Zusammen mit den Bulk-Daten werden auch Sounddaten für den VL1-m Version 2 übertragen (A01 bis A06).
- Lorsque le type de programme pré-réglé “3” est sélectionné, les données listées ci-dessous sont chargées dans la mémoire du G50. Les données de sonorités (A01-A06) du VL1-m Version 2 sont également envoyées en bloc.

MEM #	PGM	MSB	LSB	Voice name	Remarks
1	1	-	-	Shakuhachi	*1
2	2	-	-	GuitarHero	
3	3	-	-	Tenor Sax	*2
4	4	-	-	Birdland	
5	5	-	-	OldMini	
6	6	-	-	Rock Pigs	*3
7	1	-	-	Shakuhachi	*2, 4
8	2	-	-	GuitarHero	*5

- \*1 Touch Control = Breath Noise etc.
- \*2 Touch Control = Breath Noise
- \*3 Picking Position Control = Modulation
- \*4 Picking Position Control = Embouchure
- \*5 Picking Position Control = Tonguing
- \*1 TOUCH CONTROL = Breath Noise usw.
- \*2 TOUCH CONTROL = Breath Noise
- \*3 PICKING CONTROL = Modulation
- \*4 PICKING CONTROL = Embouchure
- \*5 PICKING CONTROL = Tonguing
- \*1 Contrôle de toucher = Bruit de souffle, etc.
- \*2 Contrôle de toucher = Bruit de souffle
- \*3 Contrôle de position de pincement = Modulation
- \*4 Contrôle de position de pincement = Embouchure
- \*5 Contrôle de position de pincement = Tongueing

■ Guitar/Bass select switch: when "BASS" is selected /  
 Wenn der GUITAR TYPE-Schalter auf "BASS" gestellt ist /  
 Sélecteur Guitar/Bass : Quand "BASS" est sélectionné



- Type: U (User / Anwender / utilisateur)
- When the initialize operation is executed, the data listed below will be loaded into the G50's internal memory.
- Nach einer Initialisierung werden die unten aufgeführten Daten in den Speicher des G50 geladen.
- Lorsque l'opération d'initialisation est réalisée, les données listées ci-dessous sont chargées dans la mémoire interne du G50.

MEM #	PGM	MSB	LSB	Voice name	Remarks
1	39	0	0	Syn Bass	
2	36	0	0	Pretless	
3	115	0	0	Steel Drum	
4	84	0	0	Chiff Lead	
5	82	0	0	Saw Lead	
6	49	0	0	Strings	
7	63	0	0	Syn Brass	
8	91	0	0	Poly Syn Pad	
9	2	0	0	Piano	
10	66	0	0	Alto Sax	
11	34	0	0	FngrBass	
	37	0	0	SlapSas1	*1
12	35	0	0	PickBass	
	38	0	0	SlapBas2	*2
13	30	0	0	Overdrive	
	32	0	0	Guitar Harmonics	*2
14	28	0	0	Clean Guitar	
	29	0	0	Mute Guitar	*2
15	89	0	0	New Age Pad	
16	83	0	0	Calliope Lead	
17	86	0	0	Voice Lead	
18	12	0	0	Vibes	
19	100	0	0	Atmosphere	
20	17	0	0	Draw Organ	*3

- \*1 String Split
- \*2 Picking Position Split
- \*3 Picking Position Control = Modulation
- \*1 Saiten-Split
- \*2 Positions-Split
- \*3 PICKING CONTROL = Modulation
- \*1 Partage de corde
- \*2 Partage de position de pincement
- \*3 Contrôle de position de pincement = Modulation



- Type: I
- When Preset Program Type "1" is selected, the data listed below will be loaded into the G50's memory.
- Beim Auswählen von Preset-Programmset "1" werden die unten aufgeführten Daten in den Speicher des G50 geladen.
- Lorsque le type de programme préreglé "1" est sélectionné, les données listées ci-dessous sont chargées dans la mémoire du G50.

MEM #	PGM	MSB	LSB	Voice name	Remarks
1	39	0	64	Oscar	
2	34	0	65	ModAlem	
3	115	0	0	SteelDrm	
4	63	0	45	AnaVelBr	
5	85	0	65	WireLead	
6	50	0	0	Strings2	
7	64	0	40	SynBras4	
8	91	0	66	Ana Pad	
9	5	0	45	VX EL.P1	
10	66	0	43	HyprAlto	
11	34	0	0	FngrBass	
	37	0	0	SlapSas1	*1
12	35	0	0	PickBass	
	38	0	0	SlapBas2	*2
13	30	0	43	Gt.Pin	*3
	32	0	43	VeloSlap	*3
14	38	0	43	VeloSlap	*3
15	92	0	66	Itopia	
16	86	0	64	VoxLead	
17	91	0	65	Click Pad	
18	79	0	64	HrmoRain	
19	1	0	41	Dream	
20	17	0	32	DetDrwOr	*4
21	12	0	45	HardVibe	
22	99	0	69	DigiBell	
24	39	0	35	Clv Bass	
41	29	0	45	Jazz Man	
42	40	0	64	X WireBa	
43	41	0	0	Violin	
44	43	0	0	Cello	
56	56	0	64	Impact	
65	64	0	64	AnaBrss2	
105	89	0	64	Fantasy2	
106	102	0	64	GobSyn	
107	96	0	64	PolarPad	
108	105	0	0	Sitar	
109	106	0	0	Banjo	
110	109	0	0	Kalimba	
115	99	0	67	XmasBell	
128	17	127	0	Rock Kit	

- \*1 String Split
- \*2 Picking Position Split
- \*3 The tone will change according to the amount of velocity.
- \*4 Picking Position Control = Modulation
- \*1 Saiten-Split
- \*2 Positions-Split
- \*3 Der Ton ändert sich mit der Spieldynamik.
- \*4 PICKING CONTROL = Modulation
- \*1 Partage de corde
- \*2 Partage de position de pincement
- \*3 La tonalité change selon l'importance de la vitesse.
- \*4 Contrôle de position de pincement = Modulation



- Type: 2
- When Preset Program Type “2” is selected, the data listed below will be loaded into the G50’s memory. VL 70-m tone data (Cst001-006.Int001) will also be sent with the bulk.
- Beim Auswählen von Preset-Programmset “2” werden die unten aufgeführten Daten in den Speicher des G50 geladen. Zusammen mit den Bulk-Daten werden auch Sounddaten für den VL70-m übertragen (Cst001 bis Cst006, Int001).
- Lorsque le type de programme pré-réglé “2” est sélectionné, les données listées ci-dessous sont chargées dans la mémoire du G50. Les données de sonorités (Cst001-006.Int001) du VL70-m sont également envoyées en bloc.

MEM#	PGM	MSB	LSB	Voice name	Remarks
1	3	-	2	Birdland	
2	4	-	2	OldMini	
3	1	-	2	Shakuhac	*1
4	4	-	0	GuitHero	
5	2	-	2	TenorSax	*1
6	5	-	2	RockPigs	*2
7	1	-	2	Shakuhac	*1, 3
8	1	-	3	GuitHero	*4
9	6	-	2	Yhokihi	
10	12	-	0	Igneous	
11	15	-	0	Wynth	
12	19	-	0	OsciLead	
13	20	-	0	SqrLead	
14	21	-	0	Bigger	
15	22	-	0	AnaSquid	
16	23	-	0	SharpSyn	
17	29	-	0	Fnground	
18	31	-	0	FlageoBs	
19	32	-	0	DampBass	
20	33	-	0	Fretles!	
21	35	-	0	ThumBass	
22	38	-	0	WarmBass	
23	40	-	0	Box Bass	
24	42	-	0	FruitBas	
25	44	-	0	SqrBass!	
26	45	-	0	PulsClav	
27	46	-	0	MogueBas	
28	47	-	0	BoppaBas	
29	48	-	0	BuzzrBas	
30	49	-	0	MuteHrBs	
31	51	-	0	TranzBas	
32	52	-	0	Chamlion	
33	53	-	0	ParaSynB	

- \*1 Touch Control = Breath Noise
- \*2 Picking Position Control = Modulation
- \*3 Picking Position Control = Embouchure
- \*4 Picking Position Control = Tonguing
- \*1 TOUCH CONTROL = Breath Noise
- \*2 PICKING CONTROL = Modulation
- \*3 PICKING CONTROL = Embouchure
- \*4 PICKING CONTROL = Tonguing
- \*1 Contrôle de toucher = Bruit de souffle
- \*2 Contrôle de position de pincement = Modulation
- \*3 Contrôle de position de pincement = Embouchure
- \*4 Contrôle de position de pincement = Tongueing

MEM#	PGM	MSB	LSB	Voice name	Remarks
34	54	-	0	SteamBas	
35	55	-	0	BooBass	
36	57	-	0	AtackSyn	
37	60	-	0	India	
38	61	-	0	YamSteel	
39	63	-	0	M u	
40	65	-	0	DinoPerc	
41	66	-	0	Formula	
42	67	-	0	Jurassic	
43	69	-	0	SpcHorse	
44	71	-	0	Suedhead	
45	74	-	0	JazzyGtr	
46	75	-	0	L7 Pluck	
47	80	-	0	Carlos	
48	81	-	0	Destiny	
49	83	-	0	Grunge	
50	84	-	0	Ossyncro	
51	85	-	0	Talk Box	
52	86	-	0	SyncLead	
53	87	-	0	Old Mini	
54	88	-	0	Fat Mini	
55	89	-	0	Parlapho	
56	90	-	0	SimpleSy	
57	91	-	0	Chronic	
58	92	-	0	SlitMiru	
59	94	-	0	Flaggoot	
60	95	-	0	SynSkex	
61	98	-	0	FlatLead	
62	99	-	0	PhilTur	
63	100	-	0	ChalPuls	
64	101	-	0	Pluck Id	
65	102	-	0	Brassy	
66	103	-	0	AcoSynLd	
67	104	-	0	Moby	
68	106	-	0	LyricOff	
69	107	-	0	Rezzawi	
70	108	-	0	Macro	
71	109	-	0	Claribo	
72	110	-	0	Binaphon	
73	113	-	0	Persinet	
74	114	-	0	PicoPipe	
75	115	-	0	Gertrude	
76	116	-	0	Xynth	
77	121	-	0	Electrum	
78	122	-	0	Edgeopho	
79	123	-	0	BassCla!	
80	124	-	0	WX Clari	
81	125	-	0	WX Oboe	
82	127	-	0	Shakuha!	
83	128	-	0	LipClari	
84	1	-	1	Vento	
85	3	-	1	Sintax	
86	7	-	1	LiteAlto	
87	8	-	1	Trmbone!	
88	10	-	1	Air Sax	
89	11	-	1	TemrSax!	
90	12	-	1	Coca	
91	14	-	1	Viol Inn	
92	16	-	1	BrethBow	
93	17	-	1	Trumprt!2	
94	22	-	1	Flumpet	
95	23	-	1	WXTrumprt	
96	26	-	1	Melwbone	
97	27	-	1	NerzoBr	
98	30	-	1	NuHorne	
99	31	-	1	WX Horn	
100	43	-	1	DoublBow	
101	48	-	1	C Flute2	
102	50	-	1	OakFlute	
103	52	-	1	RzdeFlt	
104	54	-	1	Nz Flute	
105	58	-	1	Bamboo	
106	60	-	1	Flurinet	

MEM#	PGM	MSB	LSB	Voice name	Remarks
107	62	-	1	Flurmod	
108	66	-	1	NuSopSax	
109	68	-	1	SoprPipe	
110	70	-	1	AnaSoprn	
111	71	-	1	NuAltSax	
112	77	-	1	AcidSax	
113	83	-	1	BellMike	
114	90	-	1	Oboe!	
115	98	-	1	Bassoon!	
116	111	-	1	Lonely	
117	114	-	1	MizuHorn	
118	117	-	1	BowLead	
119	119	-	1	MouthKey	
120	120	-	1	AmpdHarp	
121	121	-	1	CromHarp	
122	122	-	1	WahUpHp	
123	123	-	1	YamaBotl	
124	124	-	1	Blowsoo	
125	125	-	1	Brappo	
126	126	-	1	Crumbon	
127	127	-	1	Klarina	
128	128	-	1	ReedWin	



- Type: 3
- When Preset Program Type “3” is selected, the data listed below will be loaded into the G50’s memory. VL 1-m Version 2 tone data (A01-A06) will also be sent with the bulk.
- Beim Auswählen von Preset-Programmset “3” werden die unten aufgeführten Daten in den Speicher des G50 geladen. Zusammen mit den Bulk-Daten werden auch Sounddaten für den VL1-m Version 2 übertragen (A01 bis A06).
- Lorsque le type de programme préréglé “3” est sélectionné, les données listées ci-dessous sont chargées dans la mémoire du G50. Les données de sonorités (A01-A06) du VL1-m Version 2 sont également envoyées en bloc.

MEM#	PGM	MSB	LSB	Voice name	Remarks
1	4	-	-	Birdland	
2	5	-	-	OldMini	
3	1	-	-	Shakuhachi	*1
4	2	-	-	GuitarHero	
5	3	-	-	Tenor Sax	*2
6	6	-	-	Rock Pigs	*3
7	1	-	-	Shakuhachi	*2, 4
8	2	-	-	GuitarHero	*5

- \*1 Touch Control = Breath Noise etc.
- \*2 Touch Control = Breath Noise
- \*3 Picking Position Control = Modulation
- \*4 Picking Position Control = Embouchure
- \*5 Picking Position Control = Tonguing
- \*1 TOUCH CONTROL = Breath Noise usw.
- \*2 TOUCH CONTROL = Breath Noise
- \*3 PICKING CONTROL = Modulation
- \*4 PICKING CONTROL = Embouchure
- \*5 PICKING CONTROL = Tonguing
- \*1 Contrôle de toucher = Bruit de souffle, etc.
- \*2 Contrôle de toucher = Bruit de souffle
- \*3 Contrôle de position de pincement =Modulation
- \*4 Contrôle de position de pincement = Embouchure
- \*5 Contrôle de position de pincement = Tongueing

# MIDI Data Format / MIDI-Datenformat /

## 1. MIDI Receive/Send

### 1.1 Receive/Send Conditions

#### < MIDI Receive Conditions >

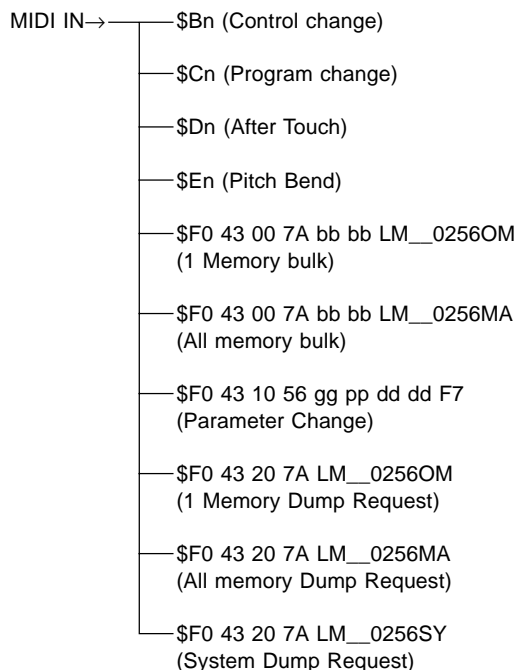

#### < MIDI Send Conditions >

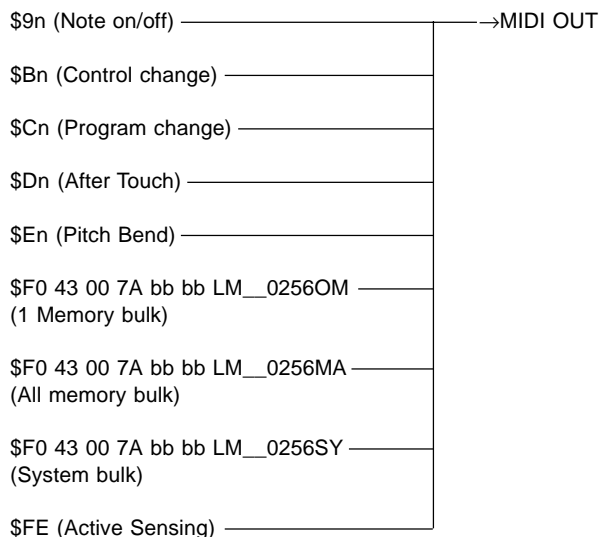

### 1.2 Channel Message

Usually during performance, strings 1-6 use 6 separate MIDI channels however, strings 1-6 can also be combined to use a single MIDI channel. Also, the ability to change between 2 voices on the same string is provided with Program changes, etc.

When the Hold function is used, a 7th MIDI channel is used to transmit data for the Hold function. Because MIDI channel 10 is normally reserved for drums and rhythm in many multi-timbral applications, channel 10 is not available in the Multi-channel mode.

#### 1.2.1 Note On/Off

Velocity range = 1-127.  
Does not receive Note On/Off Messages

#### 1.2.2 Control Change, Pitch Bend, After Touch

Data for Control Change, Pitch Bend and After Touch messages received via MIDI, are only transmitted to the currently used channels.

However, when Master Volume (\$Bn.7.0-127) is received via MIDI, it will be recognized as the External TG Control Volume's maximum volume range (SYNTH VOL=MAX) before volume control takes place.

Also, when Sustain (\$Bn.64.0/127) is received via MIDI, messages will control the sustain in the same manner (on/off) as the external sustain pedal.

Pitch Bend Sensitivity of RPN is transmitted accordingly as Pitch Bend Range settings.

Tuning Pitch settings are transmitted accordingly as RPN Fine Tuning.

#### 1.2.3 Program Change

In the Play mode, program changes of 0-127, when received, will change the Memory number 1-128. According to the Edit Buffer's Tone Generator Setup, Program Change, etc., data will be transmitted via MIDI.

In the Edit Mode, Program Changes of 0-127, when received via MIDI, will not change Memory Numbers but, Program Changes will be transmitted to the currently used channels

#### 1.2.4 Reset All Controller

The Reset All Controller is transmitted when parameters for the External TG Setup's Assignable 1,2 are changed, or Control Change by Real-time Control parameters are changed or when the newly selected memory has the above parameters assigned.

### 1.3 System Real-time Message

#### 1.3.1 Status F8, FA, FB, FC

Does not transmit or receive.

#### 1.3.2 Status F9, FD, FF

Does not transmit or receive.

### 1.4. Status FE (Active Sensing)

Transmitted every 200ms.  
Does not receive.

# Format des données MIDI

## 2. Bulk Dump

Bulk dumps and dump requests are recognized while in the Play Mode only.  
 If ALL is selected, all Memory and System Setup data will be transmitted when MIDI Bulk transmission is carried out.  
 When Data is divided into several blocks for transmission, there is an interval of 150ms between the transmission of each block.  
 Internal parameters are all 8 bit data, bit 7 is assigned as the 1st bit of the MSB (byte), MSB and LSB are always separated into 2 bytes and transmitted and received in order.  
 The Dump Request is only received when in the Play Mode.

### 2.1 Single Memory Data Bulk Dump

0	11110000	F0
1	01000011	43
2	00000000	00 = Device Number (fixed)
3	01111010	7A
4	0bbbbbbb	bbbbbbb = Byte Count
5	0bbbbbbb	bbbbbbb
6	01001100	4C(ascii"L")
7	01001101	4D(ascii"M")
8	00100000	20(ascii" ")
9	00100000	20(ascii" ")
10	00110000	30(ascii"0")
11	00110010	32(ascii"2")
12	00110101	35(ascii"5")
13	00110110	36(ascii"6")
14	01001111	4F(ascii"O")
15	01001101	4D(ascii"M")
16	00000000	00
↓	↓	↓
31	00000000	00
32	0ddddddd	ddddddd = Data
↓	↓	↓
	0sssssss	sssssss = Check Sum
	11110111	F7

\* When received, the currently selected memory of the G50 and its Edit buffer will be overwritten.  
 See < Table 1 > for more information on the format.

### 2.2 Single Memory Data Dump Request

0	11110000	F0
1	01000011	43
2	00100000	20 = Device Number (fixed)
3	01111010	7A
4	01001100	4C(ascii"L")
5	01001101	4D(ascii"M")
6	00100000	20(ascii" ")
7	00100000	20(ascii" ")
8	00110000	30(ascii"0")
9	00110010	32(ascii"2")
10	00110101	35(ascii"5")
11	00110110	36(ascii"6")
12	01001111	4F(ascii"O")
13	01001101	4D(ascii"M")
14	00000000	00
↓	↓	↓
28	00000000	00
29	0mmmmmmm	mmmmmmm (0-127) = Memory Number 1-128
30	11110111	F7

\* When received, the data bulk of the specified single memory will be transmitted.

### 2.3 All Memory Data Bulk Dump

0	11110000	F0
1	01000011	43
2	00000000	00 = Device Number (fixed)
3	01111010	7A
4	0bbbbbbb	bbbbbbb = Byte Count
5	0bbbbbbb	bbbbbbb
6	01001100	4C(ascii"L")
7	01001101	4D(ascii"M")
8	00100000	20(ascii" ")
9	00100000	20(ascii" ")
10	00110000	30(ascii"0")
11	00110010	32(ascii"2")
12	00110101	35(ascii"5")
13	00110110	36(ascii"6")
14	01001101	4D(ascii"M")
15	01000001	41(ascii"A")
16	00000000	00
↓	↓	↓
30	00000000	00
31	000mmmmm	mmmmm(0-15,16) = 0-15=Memory,16=System
32	0ddddddd	ddddddd = Data
↓	↓	↓
	0sssssss	sssssss = Check Sum
	11110111	F7

\* Bulk data for 8 memories is transmitted as in sequence as a single block. After all memory data has been transmitted, the system data will then be transmitted. See < Table 2 > for more information on the system data format.  
 When received, this data overwrites the Edit Buffer's data.

### 2.4 All Memory Data Dump Request

0	11110000	F0
1	01000011	43
2	00100000	20 = Device Number (fixed)
3	01111010	7A
4	01001100	4C(ascii"L")
5	01001101	4D(ascii"M")
6	00100000	20(ascii" ")
7	00100000	20(ascii" ")
8	00110000	30(ascii"0")
9	00110010	32(ascii"2")
10	00110101	35(ascii"5")
11	00110110	36(ascii"6")
12	01001101	4D(ascii"M")
13	01000001	41(ascii"A")
14	00000000	00
↓	↓	↓
29	00000000	00
30	11110111	F7

\* When received, all memory and the system data will be transmitted.



## 2.5 System Data Bulk Dump

0	11110000	F0
1	01000011	43
2	00000000	00 = Device Number (fixed)
3	01111010	7A
4	0bbbbbbb	bbbbbbb = Byte Count
5	0bbbbbbb	bbbbbbb
6	01001100	4C(ascii"L")
7	01001101	4D(ascii"M")
8	00100000	20(ascii" ")
9	00100000	20(ascii" ")
10	00110000	30(ascii"0")
11	00110010	32(ascii"2")
12	00110101	35(ascii"5")
13	00110110	36(ascii"6")
14	01010011	53(ascii"S")
15	01011001	59(ascii"Y")
16	00000000	00
↓	↓	↓
31	00000000	00
32	0ddddddd	ddddddd = Data
	↓	↓
	0sssssss	sssssss = Check Sum
	11110111	F7

\* See table 2 for more information on the system data format.

## 2.6 System Data Dump Request

0	11110000	F0
1	01000011	43
2	00100000	20 = Device Number (fixed)
3	01111010	7A
4	01001100	4C(ascii"L")
5	01001101	4D(ascii"M")
6	00100000	20(ascii" ")
7	00100000	20(ascii" ")
8	00110000	30(ascii"0")
9	00110010	32(ascii"2")
10	00110101	35(ascii"5")
11	00110110	36(ascii"6")
12	01010011	53(ascii"S")
13	01011001	59(ascii"Y")
14	00000000	00
↓	↓	↓
29	00000000	00
30	11110111	F7

\* When received, the system data bulk will be transmitted.

## 3. Parameter Change

Can be received when in the Play Mode only.

Parameter change's to the currently selected memory are stored in the edit buffer, if the data is to be saved, it is necessary to execute a write operation, or receive a single memory data bulk.

Internal parameters are all 8 bit data, the 7th bit is assigned as the 1st bit of the MSB (byte), MSB and LSB are always separated into 2 bytes and transmitted and received in order.

0	11110000	F0
1	01000011	43
2	00010000	10 = Device Number (fixed)
3	01010110	56 = Model ID
4	000000gg	gg = Parameter Group
5	000ppppp	ppppp = Parameter Number
6	0000000d	d = MSbit of actual data
7	0ddddddd	ddddddd = 7bit data
8	11110111	F7

\* Parameter Group =

0	Edit Buffer
1	2nd Memory for Split Function
2	Hold Memory for Hold Function
3	System

For more information on Parameter Number and Data Range, see < Table 1 > and < Table 2 >.

< Table 1 >

1 Memory Size = 25bytes  
All Memory Size = 3200bytes

Total MIDI Data Size = 50bytes

PRM#	DATA NAME	DATA RANGE	SIZE
0	Playing Style	0(pick),1(finger/slap)	2
1	Note on Level	0-9(1-10)	4
2	Note off Level	0-9(1-10)	6
3	Velocity	0(narrow),1(normal),2(wide), 3-129(fixed1-127)	8
4	Chromatic	0(off),1(on),2(auto)	10
5	Transpose	0-48(24-+24)	12
6	Pitch Bend Range	0-24(0-24)	14
7	Program Number	0(off),1-128(1-128)	16
8	Program Bank MSB	0(off),1-128(0-127)	18
9	Program Bank LSB	0(off),1-128(0-127)	20
10	Volume	0(off),1-128(0-127)	22
11	Pan	0(off),1-31(L15-R15)	24
12	Assignable Control Number 1	0(off),1-119(1-120),120(AT)	26
13	Assignable Control Value 1	0-127	28
14	Assignable Control Number 2	0(off),1-119(1-120),120(AT)	30
15	Assignable Control Value 2	0-127	32
16	Split	0(off),1-5(string1-5), 6-15(pick1-10)	34
17	Split Memory2 Number	0-127(1-128)	36
18	Split Memory2 Location	0(lo),1(hi)	38
19	Picking Position Control	0(off),1-119(1-120),120(AT)	40
20	Picking Front Position Value	0-127	42
21	Picking Rear Position Value	0-127	44
22	Touch Control	0(off),1-119(1-120),120(AT)	46
23	Touch Control Sensitivity	0-14(-7-+7)	48
24	Sustain/Hold Pedal	0(sus1),1(sus2),2-129(1-128)	50

< Table 2 >

System Size = 10bytes

Total MIDI Data Size = 20bytes

PRM#	DATA NAME	DATA RANGE	SIZE
0	MIDI CH	0-14(s1-9,11-16),15-30(c1-16), 31-46(m1-16)	2
1	Tuning	0-5(440-445)	4
2	E1 String Sens	0-49(1-50)	6
3	B2 String Sens	0-49(1-50)	8
4	G3 String Sens	0-49(1-50)	10
5	D4 String Sens	0-49(1-50)	12
6	A5 String Sens	0-49(1-50)	14
7	E6 String Sens	0-49(1-50)	16
8	G1D Function	0(DE),1(pgm),2(octave)	18
9	Hold1/2	0(hold1),1(hold2)	20

YAMAHA [Guitar MIDI Converter]  
 Model G50 MIDI Implementation Chart

Date:21-MAY-1996  
 Version : 1.0

Function ...	Transmitted	Recognized	Remarks
Basic Default	: 1-16	: 1-16	: memorized
Channel Changed	: 1-16	: 1-16	:
Mode Default	: x	: x	:
Mode Messages	: x	: x	:
Mode Altered	: *****	: x	:
Note Number : True voice	: 0-127 *****	: x	:
Velocity Note ON	: o 9nH,v=1-127	: x	:
Velocity Note OFF	: x	: x	:
After Touch	: Key's Ch's	: x o	: *1
Pitch Bender	: o	: o	: *1
	: 0-120	: o	: *1
Control Change	:	:	:
	: 121	: o	: x Reset All Ctrls
Prog Change : True #	: o 0-127	: o 0-127	: *3
	:	: *2	:
System Exclusive	: o	: o	:
System : Song Pos.	: x	: x	:
System : Song Sel.	: x	: x	:
Common : Tune	: x	: x	:
System :Clock	: x	: x	:
Real Time :Commands	: x	: x	:
Aux :Local ON/OFF	: x	: x	:
Aux :All Notes OFF	: x	: x	:
Mes- :Active Sense	: o	: x	:
sages:Reset	: x	: x	:
:Note *1 transmits to all occupied channels.			
: *2 in the play mode: transmits pgm changes belonging to H:program memory.			
: *3 in the play mode: changes program memories.			
: in the edit mode: transmits to all occupied channels.			
Mode 1	: OMNI ON, POLY	Mode 2	: OMNI ON, MONO o : Yes
Mode 3	: OMNI OFF, POLY	Mode 4	: OMNI OFF, MONO x : No

**YAMAHA**  
YAMAHA CORPORATION