

YAMAHA AX-9

Natural Sound Stereo Integrated Amplifier

Préampli/ampli de puissance stéréo de la série "Natural Sound"

Natural Sound Stereo-Verstärker

Natural Sound Integrerad Stereo Förstärkare

Amplificatore integrato stereo a Suono Naturale

Amplificador integrado estéreo de Sonido Natural

Natural Sound Geïntegreerde Stereo Versterker

**OWNER'S MANUAL
MODE D'EMPLOI
BEDIENUNGSANLEITUNG
BRUKSANVISNING
MANUALE DI ISTRUZIONI
MANUAL DE INSTRUCCIONES
GEBRUIKSAANWIJZING**

SUPPLIED ACCESSORIES
ACCESSOIRES FOURNIS
MITGELIEFERTES ZUBEHÖR
MEDFÖLJANDE TILLBEHÖR
ACCESSORI IN DOTAZIONE
ACCESORIOS INCLUIDOS
BIJGELEVERDE ACCESSOIRES

- After unpacking, check that the following parts are contained.
- Après le déballage, vérifier que les pièces suivantes sont incluses.
- Nach dem Auspacken überprüfen, ob die folgenden Teile vorhanden sind.
- Kontrollera efter det apparaten packats upp att följande delar finns med.
- Verificare che tutte le parti seguenti siano contenute nell'imballaggio dell'apparecchio.
- Desembale el aparato y verificar que los siguientes accesorios están en la caja.
- Controleer na het uitpakken of de volgende onderdelen voorhanden zijn.

- Remote Control Transmitter
- Emetteur de télécommande
- Fernbedienung
- Fjärrkontroll
- Telecomando
- Transmisor del control remoto
- Afstandbediening

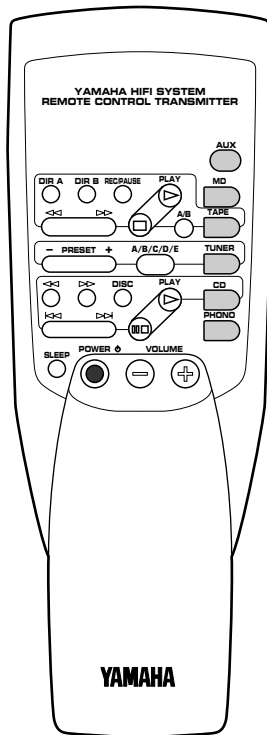

- Batteries (size AA, R6, UM-3)
- Piles (taille AA, R6, UM-3)
- Batterien (Größe AA, R6, UM-3)
- Batterier (storlek AA, R6, UM-3)
- Batterie (dimensioni AA, R6, UM-3)
- Pilas (tamaño AA, R6, UM-3)
- Batterijen (maat AA, R6, UM-3)

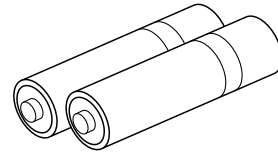

Thank you for selecting this YAMAHA stereo amplifier.

FEATURES

- **50W + 50W (8Ω) RMS Output Power, 0.03% THD, 20–20,000 Hz**
- **High Dynamic Power, Low Impedance Drive Capability**
- **PURE DIRECT Switch to Reproduce the Purest Source Sound**
- **Remote Control Capability**

CONTENTS

Supplied Accessories	2
Caution	4
Notes about the Remote Control Transmitter	5
Connections	6
Controls and Their Functions	8
Operations	10
Troubleshooting	13
Specifications	14

CAUTION: READ THIS BEFORE OPERATING YOUR UNIT.

1. To assure the finest performance, please read this manual carefully. Keep it in a safe place for future reference.
2. Install this unit in a cool, dry, clean place – away from windows, heat sources, sources of excessive vibration, dust, moisture and cold. Avoid sources of humming (transformers, motors). To prevent fire or electrical shock, do not expose the unit to rain or water.
3. Never open the cabinet. If something drops into the set, contact your dealer.
4. Do not use force on switches, controls or connection wires. When moving the unit, first disconnect the power plug and the wires connected to other equipment. Never pull the wires themselves.
5. The openings on the cabinet assure proper ventilation of the unit. If these openings are obstructed, the temperature inside the cabinet will rise rapidly and eventually damage the circuits. Therefore, avoid placing objects against these openings and do not install the unit where the flow of air through the ventilation openings could be impeded.
6. Always set the VOLUME control to “0” before starting the audio source play: increase the volume gradually to an appropriate level after the play has been started.
7. Do not attempt to clean the unit with chemical solvents; this might damage the finish. Use a clean, dry cloth.
8. Be sure to read the “TROUBLESHOOTING” section regarding common operating errors before concluding that the unit is faulty.
9. **When not planning to use this unit for long periods of time (ie., vacation, etc.), disconnect the AC power plug from the wall outlet.**
10. To prevent lightning damage, disconnect the AC power plug and disconnect the antenna cable when there is an electrical storm.
11. Grounding or polarization – Precautions should be taken so that the grounding or polarization of an appliance is not defeated.
12. AC outlet
Do not connect audio equipment to the AC outlet on the rear panel if that equipment requires more power than the outlet is rated to provide.
13. **Voltage Selector (General Model only)**
The voltage selector on the rear panel of this unit must be set for your local main voltage BEFORE plugging into the AC main supply.
Voltages are 110/120/220/240V AC, 50/60 Hz.

IMPORTANT

Please record the serial number of this unit in the space below.

Serial No.:

The serial number is located on the rear of the unit.
Retain this Owner's Manual in a safe place for future reference.

WARNING

TO REDUCE THE RISK OF FIRE OR ELECTRIC SHOCK, DO NOT EXPOSE THIS UNIT TO RAIN OR MOISTURE.

For U.K. customers

If the socket outlets in the home are not suitable for the plug supplied with this appliance, it should be cut off and an appropriate 3 pin plug fitted. For details, refer to the instructions described below.

Note: The plug severed from the mains lead must be destroyed, as a plug with bared flexible cord is hazardous if engaged in a live socket outlet.

SPECIAL INSTRUCTIONS FOR U.K. MODEL

IMPORTANT:

The wire in the mains lead are coloured in accordance with the following code:

Blue: NEUTRAL
Brown: LIVE

The colours of the wires in the mains lead of this apparatus may not correspond with the coloured markings identifying the terminals in your plug. Proceed as follows: the wire which is coloured BLUE must be connected to the terminal which is marked with the letter N or coloured BLACK. The wire which is coloured BROWN must be connected to the terminal which is marked with the letter L or coloured RED. Making sure that neither core is connected to the earth terminal of the three pin plug.

This unit is not disconnected from the AC power source as long as it is connected to the wall outlet, even if this unit itself is turned off.

In this state, this unit is designed to consume a very small quantity of power.

WARNING

Do not change the IMPEDANCE SELECTOR switch setting while the power to this unit is on, otherwise this unit may be damaged.

IF THIS UNIT FAILS TO TURN ON WHEN THE STANDBY/ON SWITCH IS PRESSED

The IMPEDANCE SELECTOR switch may not be set to either end closely. If so, set the switch to either end closely.

IMPEDANCE SELECTOR

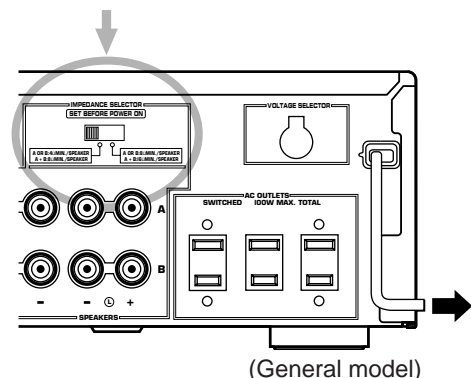

NOTES ABOUT THE REMOTE CONTROL TRANSMITTER

Battery installation

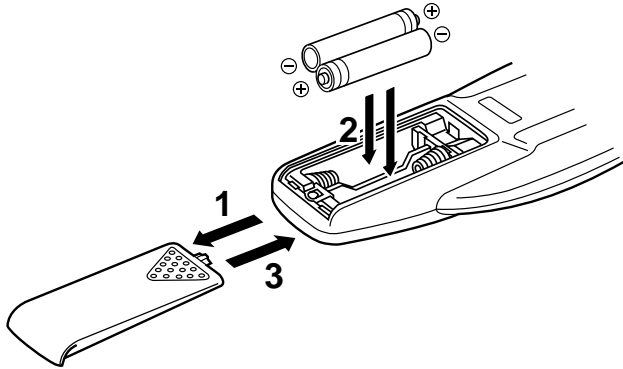

Battery replacement

If you find that the remote control transmitter must be used closer to the main unit, the batteries are weak. Replace both batteries with new ones.

Notes

- Use only AA, R6, UM-3 batteries for replacement.
- Be sure the polarities are correct. (See the illustration inside the battery compartment.)
- Remove the batteries if the remote control transmitter will not be used for an extended period of time.
- If batteries leak, dispose of them immediately. Avoid touching the leaked material or letting it come in contact with clothing, etc. Clean the battery compartment thoroughly before installing new batteries.

Remote control transmitter operation range

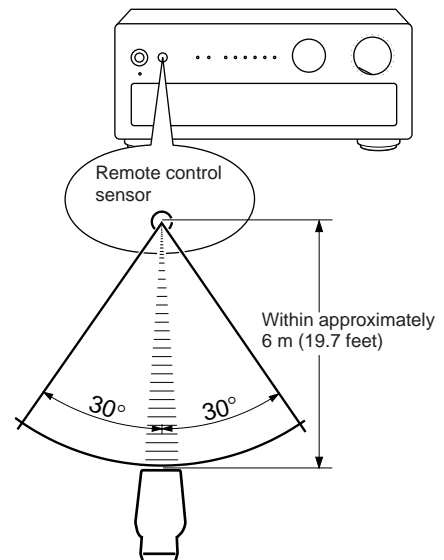

Notes

- There should be no large obstacles between the remote control transmitter and the main unit.
- If the remote control sensor is directly illuminated by strong lighting (especially an inverter type of fluorescent lamp etc.), it might cause the remote control transmitter not to work correctly. In this case, reposition the main unit to avoid direct lighting.

CONNECTIONS

Never plug in this unit and other components until all connections are completed.

- When making connections between this unit and other components, be sure all connections are made correctly, that is to say L (left) to L, R (right) to R, “+” to “+” and “-” to “-”. Also, refer to the owner’s manual for each component to be connected to this unit.
- If you have YAMAHA components numbered as 1, 2, 3, etc. on the rear panel, connections can be made easily by making sure to connect the output (or input) terminals of each component to the same-numbered terminals of this unit.

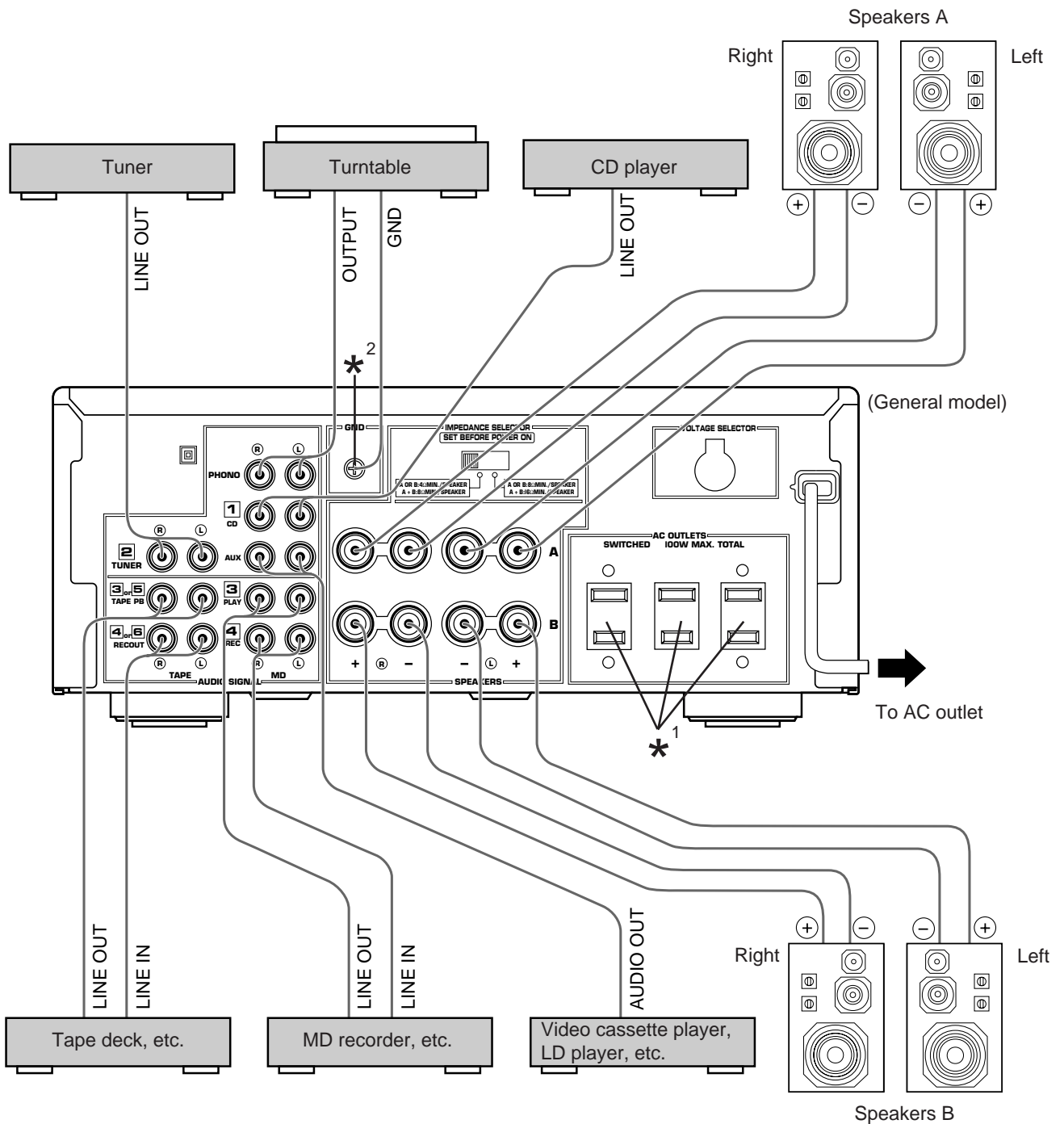

*¹, *² : Refer to “ABOUT THE ACCESSORY TERMINALS” on page 7.

CONNECTING SPEAKERS

Connect the **SPEAKERS** terminals to your speakers with wire of the proper gauge, cut as short as possible. If the connections are faulty, no sound will be heard from the speakers. Make sure that the polarity of the speaker wires is correct, that is, + and – markings are observed. If these wires are reversed, the sound will be unnatural and will lack bass.

Do not let the bare speaker wires touch each other and do not let them touch the metal parts of this unit as this could damage this unit and/or speakers.

How to Connect:

Red: positive (+)
Black: negative (–)

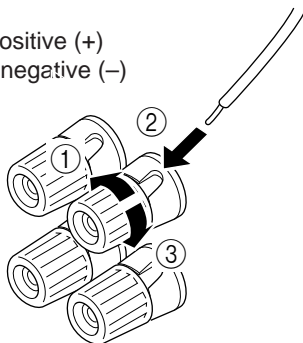

- ① Unscrew the knob.
- ② Insert the bare wire.
[Remove approx. 5mm (1/4") insulation from the speaker wires.]
- ③ Tighten the knob and secure the wire.

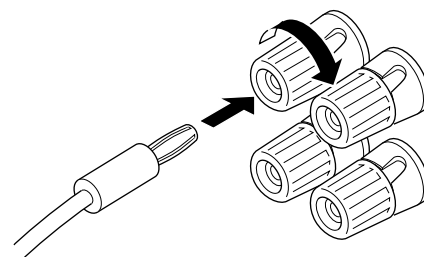

- One or two speaker systems can be connected to this unit. If you connect only one speaker system, connect it to either the **SPEAKERS A** or **B** terminals.
- Use speakers with the specified impedance shown on the rear of this unit.
- **<General model only>**
Banana Plug connections are also possible. Simply insert the Banana Plug connector into the corresponding terminal.

IMPEDANCE SELECTOR switch

Be sure to switch this only when the power to this unit is not on.

Select the position whose requirements your speaker system meets.

WARNING

Do not change the IMPEDANCE SELECTOR switch setting while the power to this unit is on, otherwise this unit may be damaged.

IF THIS UNIT FAILS TO TURN ON WHEN THE STANDBY/ON SWITCH IS PRESSED

The **IMPEDANCE SELECTOR** switch may not be set to either end closely. If so, set the switch to either end closely.

(General model)

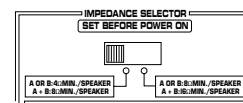

(Left position)

If you use one pair of speakers, the impedance of each speaker must be 4Ω or higher.

If you use two pairs of speakers, the impedance of each speaker must be 8Ω or higher.

(Right position)

If you use one pair of speakers, the impedance of each speaker must be 8Ω or higher.

If you use two pairs of speakers, the impedance of each speaker must be 16Ω or higher.

ABOUT THE ACCESSORY TERMINALS

AC OUTLET(S) (SWITCHED) *¹

(Europe and General models)

..... 3 SWITCHED OUTLETS
(U.K. model) 1 SWITCHED OUTLET

Use these to connect the power cords from your components to this unit.

The power to the **SWITCHED** outlets is controlled by this unit's **STANDBY/ON** switch or the provided remote control transmitter's **POWER** key. These outlets will supply power to any component whenever this unit is turned on.

The maximum power (total power consumption of components) that can be connected to the **SWITCHED AC OUTLET(S)** is 100 watts.

GND terminal (For turntable use) *²

Connecting the ground wire of the turntable to this terminal will normally minimize hum, but in some cases better results may be obtained with the ground wire disconnected.

CONTROLS AND THEIR FUNCTIONS

FRONT PANEL

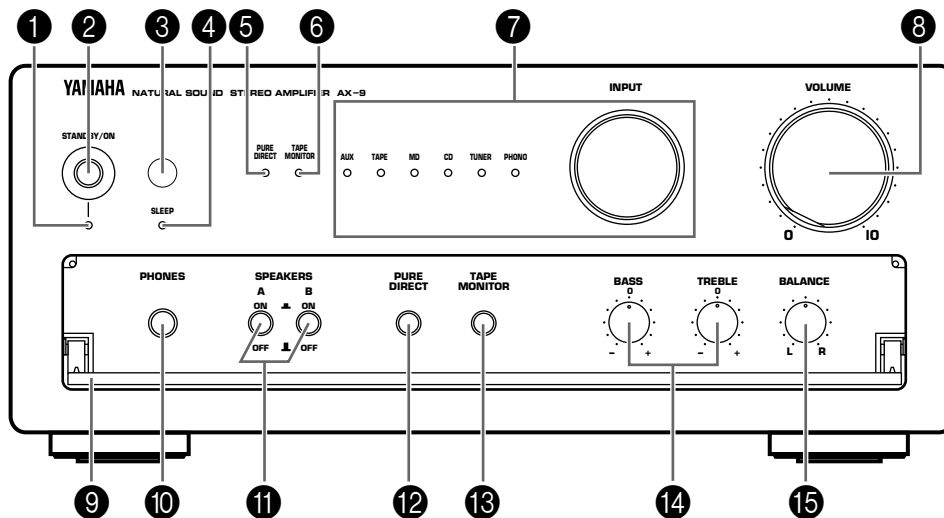

1 Power indicator

Lights up while the power to this unit is on.

2 STANDBY/ON switch

Press this switch to turn the power to this unit on. Press it again to turn this unit into the standby mode.

Standby mode

In this state, this unit consumes a very small quantity of power to receive infrared-signals from the remote control transmitter.

3 Remote control sensor

Receives signals from the remote control transmitter.

4 SLEEP indicator

Lights up while the built-in SLEEP timer is functioning.

5 PURE DIRECT indicator

Lights up while the **PURE DIRECT** switch is on.

6 TAPE MONITOR indicator

Lights up while the **TAPE MONITOR** switch is on.

* When the tape deck (**TAPE**) is selected as the input source, this indicator will not light up even if the **TAPE MONITOR** switch is on.

7 INPUT selector and indicators

When turned, selects a program source to listen to. The indicator for the currently selected source lights up.

8 VOLUME control

Used to raise or lower the volume level.

9 Control door

See page 12 for how to open and close the control door.

10 PHONES jack

When you listen with headphones, connect the headphones to the **PHONES** jack.

When listening with headphones privately, set both the **SPEAKERS A** and **B** switches to the **OFF** position.

PHONES

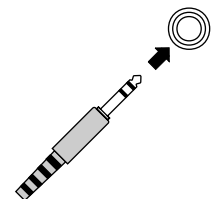

11 SPEAKERS switches

Set the switch **A** or **B** (or both **A** and **B**) for the speaker system (connected to this unit) you will use to the **ON** position. Set the switch for the speaker system you will not use to the **OFF** position.

12 PURE DIRECT switch

You can enjoy the purest possible sound from your audio sources by pressing this switch so that the **PURE DIRECT** indicator lights up. By doing so, the audio signal bypasses the **BASS**, **TREBLE** and **BALANCE** controls, eliminating any alterations to the audio signal.

13 TAPE MONITOR switch

When the tape deck connected to the **TAPE** terminals on the rear of this unit is used for recording, you can monitor the sounds being recorded by pressing **TAPE MONITOR** so that **TAPE MONITOR** indicator lights up.

14 Tone controls

BASS

Used to increase or decrease the low frequency response. The 0 position produces flat response.

TREBLE

Used to increase or decrease the high frequency response. The 0 position produces flat response.

15 BALANCE control

Adjusts the balance of the output volume to the left and right speakers to compensate for sound imbalance caused by speaker location or listening room conditions.

REMOTE CONTROL TRANSMITTER

The remote control transmitter provided with this unit is designed to control all the most commonly used functions of this unit. If the CD player, tuner or tape deck connected to this unit are YAMAHA components designed for remote control compatibility, then this remote control transmitter will also control various functions of each component.

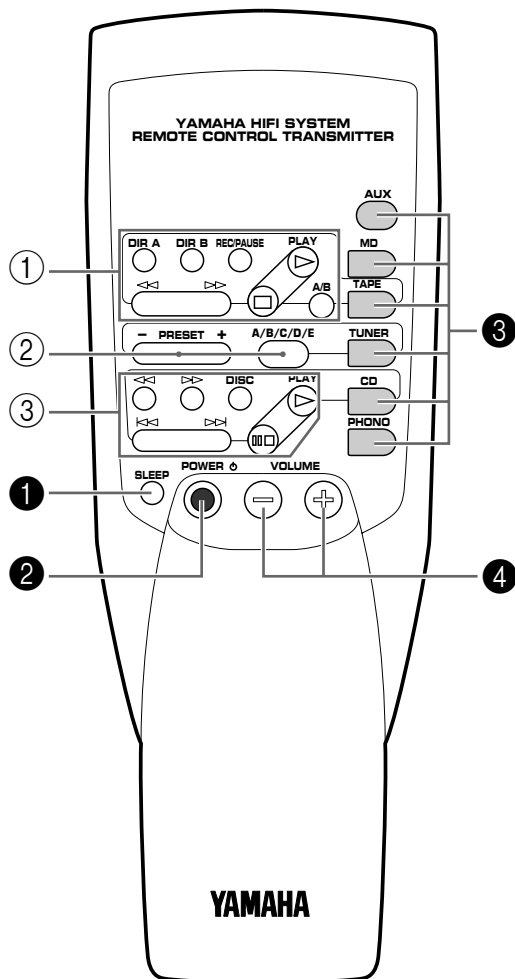

For Control of This Unit

① SLEEP timer key

This unit is automatically turned into the standby mode one hour after this key is pressed (so that SLEEP indicator lights up).

② POWER key

Turns the power to this unit on and turns this unit into the standby mode alternately.

③ Input selector keys

Selects input source.

④ VOLUME +/- keys

Turns the volume level up/down.

For Other Component Control

Identify the remote control transmitter keys with your component's keys. If these keys are identical, their functions will be the same. On each key function, refer to the corresponding instruction on your component's manual.

① Tape deck keys

Controls tape deck.

- * **DIR A, B** and **A/B** are applicable only to double cassette tape deck.
- * For a single cassette deck with automatic reverse function, pressing **DIR A** will reverse the direction of tape running.

② Tuner keys

Controls tuner.

+: Selects higher preset station number.

-: Selects lower preset station number.

A/B/C/D/E: Selects the group (A – E) of preset station numbers.

③ CD player keys

Controls compact disc player.

- * **DISC** is applicable only to compact disc changer.

OPERATIONS

TO PLAY A SOURCE

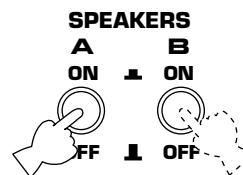
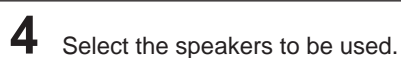
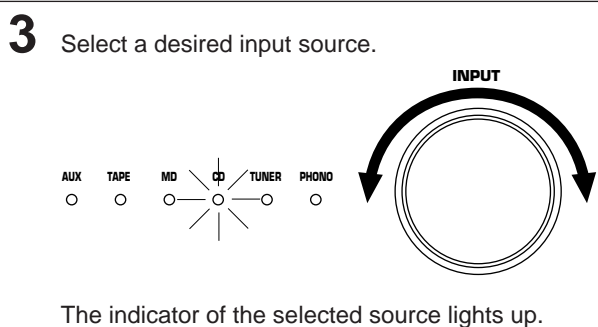
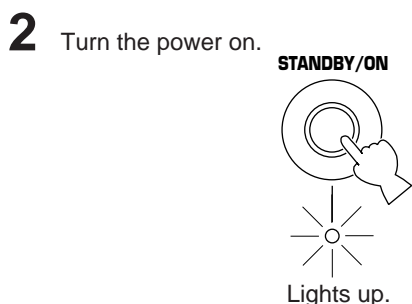
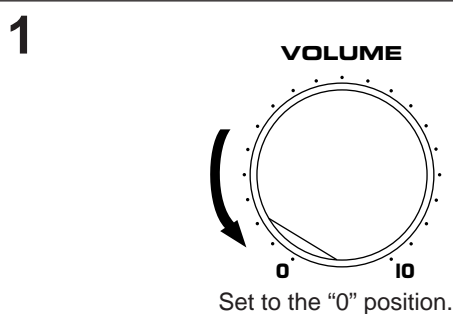
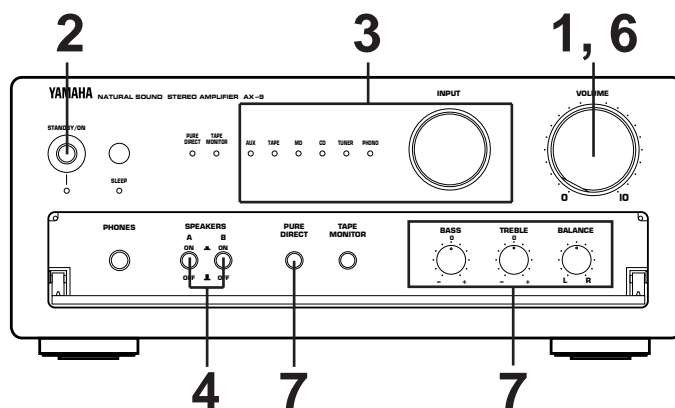

* If you use two speaker systems, press both the A and B switches.

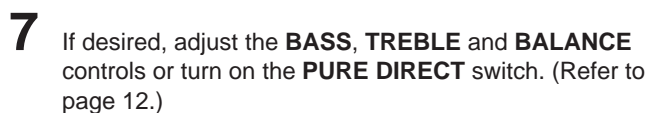
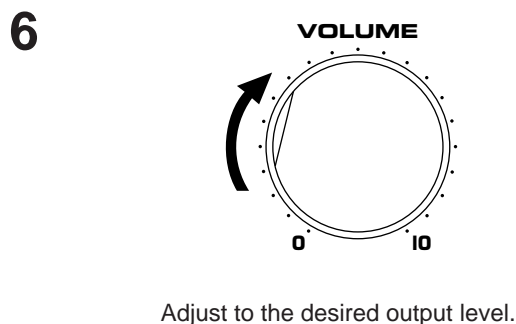
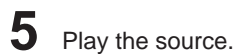

When you finish using this unit

Press the **STANDBY/ON** switch again to turn this unit into the standby mode.

Standby mode

In this state, this unit consumes a very small quantity of power to receive infrared-signals from the remote control transmitter.

TO RECORD A SOURCE TO TAPE (OR MD)

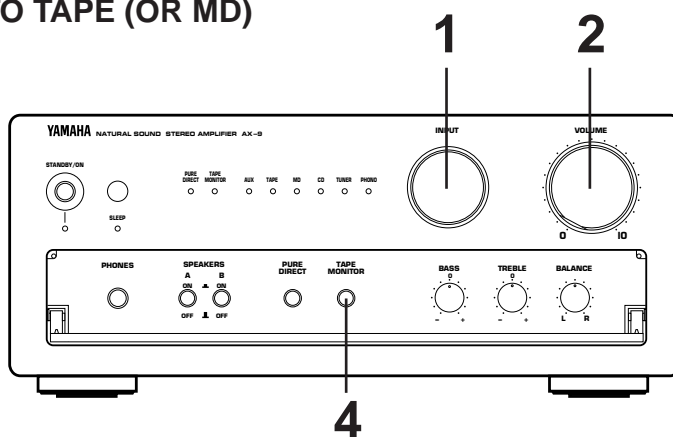

- 1** Select the source to be recorded.

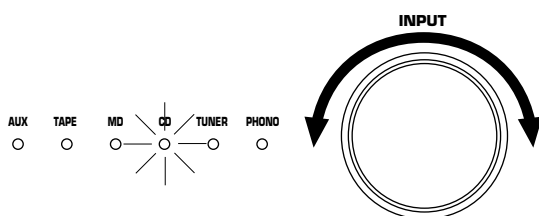

- 2** Play the source and then turn the **VOLUME** control up to confirm the input source.

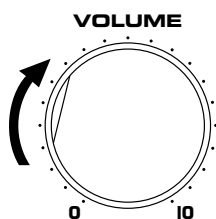

- 3** Begin recording on the tape deck (or MD recorder etc.) connected to this unit.

- 4** If the tape deck connected to the TAPE terminals on the rear of this unit is used for recording, you can monitor the sounds being recorded by pressing **TAPE MONITOR** so that TAPE MONITOR indicator lights up.

**TAPE
MONITOR**



**TAPE
MONITOR**



Lights up.

Notes

The settings of the **VOLUME**, **BASS**, **TREBLE**, **BALANCE** controls and **PURE DIRECT** switch have no effect on the material being recorded.

When you listen with headphones

Connect the headphones to the **PHONES** jack. When listening with headphones privately, set both the **SPEAKERS A** and **B** switches to the OFF position.

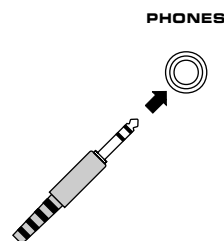

Adjusting the BALANCE control

Adjust the balance of the output volume to the left and right speakers to compensate for sound imbalance caused from speaker location or listening room conditions.

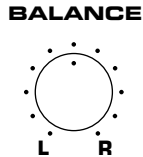

Selecting the SPEAKER system

Because one or two speaker systems can be connected to this unit, the **SPEAKERS** switches allow you to select speaker system **A** or **B**, or both at once.

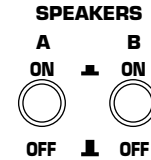

Adjusting the BASS and TREBLE controls

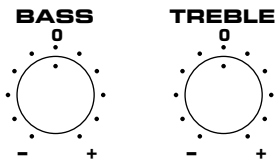

BASS : Turn this clockwise to increase (or counter-clockwise to decrease) the low frequency response.

TREBLE : Turn this clockwise to increase (or counter-clockwise to decrease) the high frequency response.

Using the PURE DIRECT switch

You can enjoy the purest possible sound from your audio sources by pressing this switch so that the **PURE DIRECT** indicator lights up. By doing so, the audio signal bypasses the **BASS**, **TREBLE** and **BALANCE** controls, eliminating any alterations to the audio signal.

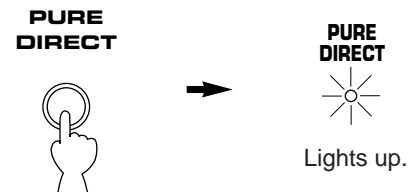

Open/close the control door

When it is not necessary to operate controls inside the control door, close the door.

To open the door

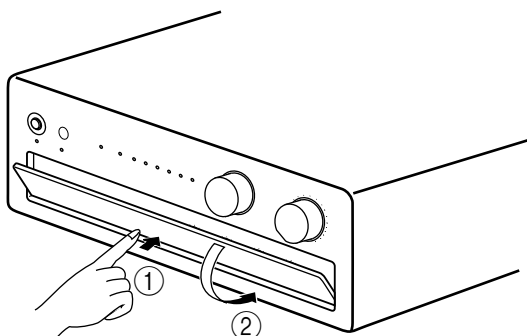

To close the door

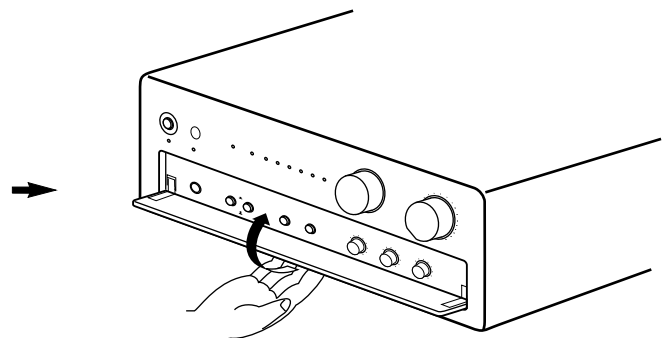

TROUBLESHOOTING

If the unit fails to operate normally, check the following points to determine whether the fault can be corrected by the simple measures suggested. If it cannot be corrected, or if the fault is not listed in the SYMPTOM column, disconnect the power cord and contact your authorized YAMAHA dealer or service center for help.

SYMPTOM	CAUSE	REMEDY
The unit fails to turn on when the STANDBY/ON switch is pressed, or turns into the standby mode suddenly soon after the power is turned on.	Power cord is not plugged in or is not completely inserted.	Firmly plug in the power cord.
	The IMPEDANCE SELECTOR switch on the rear panel is not set to either end closely.	Set the switch to either end closely.
It happens that this unit does not work normally.	There is an influence of strong external noise (lightning, excessive static electricity, etc.) or a misoperation on this unit while using this unit.	Turn this unit into the standby mode and disconnect the AC power cord from the AC outlet. After about 30 seconds have passed, connect the power and operate this unit again.
No sound.	Incorrect output cord connections.	Connect the cords properly. If the problem persists, the cords may be defective.
	Appropriate input source is not selected.	Select an appropriate input source with the INPUT selector.
	The SPEAKERS switches are not set properly.	Set the SPEAKERS switch which corresponds to the speakers to be used to the ON position.
	Speaker connections are not secure.	Secure the connections.
The sound suddenly goes off.	The protection circuit has been activated because of short circuit etc.	Turning the unit into the standby mode and then on will reset the protection circuit.
	The SLEEP timer has functioned.	Cancel the SLEEP timer function.
Only one side speaker outputs the sound.	Incorrect setting of the BALANCE control.	Adjust it to the appropriate position.
	Incorrect cord connections.	Connect the cords properly. If the problem persists, the cords may be defective.
There is a lack of bass, and no ambience.	The + and – wires are connected in reverse at the amplifier or speakers.	Connect the speaker wires in the correct phase (+ and –).
Sound “hums”.	Incorrect cord connections.	Firmly connect the audio plugs. If the problem persists, the cords may be defective.
	No connection from the turntable to the GND terminal.	Make the GND connection between the turntable and this unit.
The volume level is low while playing a record.	The record is being played on a turntable with an MC cartridge.	The player should be connected to the unit through the MC head amplifier.
The volume level cannot be increased, or sound is distorted.	The component connected to the REC OUT terminals of this unit is in the standby mode.	Turn the power to the component on.
The sound is degraded when listening with the headphones connected to the compact disc player or cassette deck that are connected with this unit.	This unit is in the standby mode.	Turn the power to this unit on.
Using the BASS, TREBLE and BALANCE controls does not affect the tone.	The PURE DIRECT switch is ON.	The PURE DIRECT switch must be switched OFF to use those controls.
The remote control transmitter does not work.	Direct sunlight or lighting (of an inverter type of fluorescent lamp etc.) is striking the remote control sensor of the main unit.	Change position of the main unit.
The distance or range within which the remote control transmitter can be used is short.	The batteries of this remote control transmitter are too weak.	Replace the batteries with new ones.

SPECIFICATIONS

Minimum RMS Output Power per Channel 8 ohms, 20 Hz to 20 kHz, 0.03% THD	50W+50W	Total Harmonic Distortion (20 Hz to 20 kHz) PHONO MM to REC OUT	0.02%
		CD/TUNER/TAPE/MD/AUX to SP OUT (25W/8 ohms).....	0.02%
Dynamic Power per Channel (by IHF Dynamic Headroom measuring method) 8/6/4/2 ohms.....	78/88/100/112W	Signal-to-Noise Ratio (IHF-A Network) PHONO MM (5 mV Input Shorted).....	82 dB
		CD/TUNER/TAPE/MD/AUX (150 mV Input Shorted) ...	105 dB
DIN Standard Output Power per Channel (4 ohms, 1 kHz, 0.7% THD) [U.K. and Europe models only].....	65W	Residual Noise (IHF-A Network).....	100 μ V
IEC Power (8 ohms, 1 kHz, 0.03% THD) [U.K. and Europe models only].....	65W	Channel Separation (Vol. -30 dB) PHONO MM (Input 0 ohm Terminated 1 kHz)	60 dB
		CD/TUNER/TAPE/MD/AUX (Input 5.1 k-ohms Terminated 1 kHz)	60 dB
Power Band Width 8 ohms, 25W, 0.06% THD.....	10 Hz to 40 kHz	Tone Control Characteristics BASS:	
		Boost/cut.....	\pm 10 dB (50 Hz)
Damping Factor 8 ohms, 20 Hz-20 kHz	80 or more	Turnover Frequency	350 Hz
Maximum Output Power (8 ohms, 1 kHz, 10% THD) [General model only].....	70W	TREBLE:	
		Boost/cut.....	\pm 10 dB (20 kHz)
		Turnover Frequency	3.5 kHz
Input Sensitivity/Impedance PHONO MM.....	2.5 mV/47 k-ohms	Power Supply [U.K. and Europe models].....	AC 230V, 50 Hz
CD/TUNER/TAPE/MD/AUX.....	150 mV/47 k-ohms	[General model]	AC 110/120/220/240V, 50/60 Hz
Maximum Input Signal (1 kHz, 0.04% THD) PHONO MM	90 mV	Power Consumption.....	120W
Output Level/Impedance REC OUT	150 mV/800 ohms	AC Outlets 3 SWITCHED OUTLETS [Europe and General models].....	100W max. total
Headphone Jack Rated Output/ Impedance Output Level (8 ohms, 1 kHz, 0.03% THD)	0.4V	1 SWITCHED OUTLET [U.K. model].....	100W max. total
Impedance	390 ohms	Dimensions (W x H x D)	280 x 118.5 x 388.5 mm
Frequency Response (20 Hz to 20 kHz) CD/TUNER/TAPE/MD/AUX	0 \pm 0.5 dB	(11" x 4-11/16" x 15-5/16")
RIAA Equalization Deviation (20 Hz to 20 kHz) PHONO MM	0 \pm 0.5 dB	Weight.....	6.1 kg (13 lbs. 7 oz.)
		Accessories.....	Remote control transmitter Batteries

Specifications subject to change without notice.

YAMAHA

YAMAHA ELECTRONICS CORPORATION, USA 6660 ORANGETHORPE AVE., BUENA PARK, CALIF. 90620, U.S.A.
YAMAHA CANADA MUSIC LTD. 135 MILNER AVE., SCARBOROUGH, ONTARIO M1S 3R1, CANADA
YAMAHA ELECTRONIK EUROPA G.m.b.H. SIEMENSSTR. 22-34, 25462 RELINGEN BEI HAMBURG, F.R. OF GERMANY
YAMAHA ELECTRONIQUE FRANCE S.A. RUE AMBROISE CROIZAT BP70 CROISSY-BEAUBOURG 77312 MARNE-LA-VALLEE CEDEX02, FRANCE
YAMAHA ELECTRONICS (UK) LTD. YAMAHA HOUSE, 200 RICKMANSWORTH ROAD WATFORD, HERTS WD1 7JS, ENGLAND
YAMAHA SCANDINAVIA A.B. J A WETTERGRENS GATA 1, BOX 30053, 400 43 VÄSTRA FRÖLUNDA, SWEDEN
YAMAHA MUSIC AUSTRALIA PTY, LTD. 17-33 MARKET ST., SOUTH MELBOURNE, 3205 VIC., AUSTRALIA

YAMAHA
YAMAHA CORPORATION
VZ21860