

CENTER

YAMAHA KPA-501

Digital Karaoke Processing Amplifier

OWNER'S MANUAL



IMPORTANT!

Please record the serial number of this unit in the space below.

Model: KPA-501

Serial No.:

The serial number is located on the rear of the unit.
Retain this Owner's Manual in a safe place for future reference.

SAFETY INSTRUCTIONS



• Explanation of Graphical Symbols



The lightning flash with arrowhead symbol, within an equilateral triangle, is intended to alert you to the presence of uninsulated "dangerous voltage" within the product's enclosure that may be of sufficient magnitude to constitute a risk of electric shock to persons.

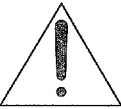

The exclamation point within an equilateral triangle is intended to alert you to the presence of important operating and maintenance (servicing) instructions in the literature accompanying the appliance.

WARNING

To reduce the risk of fire or electric shock, do not expose this unit to rain or moisture.

- 1 Read Instructions – All the safety and operating instructions should be read before the appliance is operated.
- 2 Retain Instructions – The safety and operating instructions should be retained for future reference.
- 3 Heed Warnings – All warnings on the appliance and in the operating instructions should be adhered to.
- 4 Follow Instructions – All operating and use instructions should be followed.
- 5 Attachments – Do not use attachments not recommended by the video product manufacturer as they may cause hazards.
- 6 Water and Moisture – Do not use this unit near water – for example, near a bath tub, wash bowl, kitchen sink, or laundry tub, in a wet basement, or near a swimming pool, and the like.
- 7 Carts and Stands – The appliance should be used only with a cart or stand that is recommended by the manufacturer.
- 7A An appliance and cart combination should be moved with care. Quick stops, excessive force, and uneven surfaces may cause the appliance and cart combination to overturn.
 
- 8 Ventilation – The appliance should be situated so that its location or position does not interfere with its proper ventilation. For example, the appliance should not be situated on a bed, sofa, rug, or similar surface that may block the ventilation openings; or, placed in a built-in installation, such as a bookcase or cabinet that may impede the flow of air through the ventilation openings.
- 9 Heat – The appliance should be situated away from heat sources such as radiators, heat registers, stoves, or other appliances (including amplifiers) that produce heat.
- 10 Power Sources – The appliance should be connected to a power supply only of the type described in the operating instructions or as marked on the appliance.
- 11 Grounding or Polarization – Precautions should be taken so that the grounding or polarization means of an appliance is not defeated.
- 12 Power-Cord Protection – Power-supply cords should be routed so that they are not likely to be walked on or pinched by items placed upon or against them, paying particular attention to cords at plugs, convenience receptacles, and the point where they exit from the appliance.
- 13 Cleaning – Unplug this unit from the wall outlet before cleaning. Do not use liquid cleaners or aerosol cleaners. Use a damp cloth for cleaning.
- 14 Power Lines – An outdoor antenna should be located away from power lines.
- 15 Nonuse Periods – The power cord of the appliance should be unplugged from the outlet when left unused for a long period of time.
- 16 Object and Liquid Entry – Care should be taken so that objects do not fall and liquids are not spilled into the enclosure through openings.
- 17 Damage Requiring Service – The appliance should be serviced by qualified service personnel when:
 - A. The power-supply cord or plug has been damaged; or
 - B. Objects have fallen into the appliance; or
 - C. The appliance has been exposed to rain; or
 - D. The appliance does not appear to operate normally or exhibits a marked change in performance; or
 - E. The appliance has been dropped, or the enclosure damaged.
- 18 Servicing – The user should not attempt to service the appliance beyond that described in the operating instructions. All other servicing should be referred to qualified service personnel.

CAUTION

The apparatus is not disconnected from the AC power source so long as it is connected to the wall outlet, even if the apparatus itself is turned off.

Note to CATV system installer (U.S.A.):

This reminder is provided to call the CATV system installer's attention to Article 820-40 of the NEC that provides guidelines for proper grounding and, in particular, specifies that the cable ground shall be connected to the grounding system of the building, as close to the point of cable entry as practical.

FCC INFORMATION (U.S.A.)

1. IMPORTANT NOTICE: DO NOT MODIFY THIS UNIT!

This product, when installed as indicated in the instructions contained in this manual, meets FCC requirements. Modifications not expressly approved by Yamaha may void your authority, granted by the FCC, to use the product.

2. IMPORTANT: When connecting this product to accessories and/or another product use only high quality shielded cables. Cable/s supplied with this product MUST be used. Follow all installation instructions. Failure to follow instructions could void your FCC authorization to use this product in the USA.

3. NOTE: This product has been tested and found to comply with the requirements listed in FCC Regulations, Part 15 for Class "B" digital devices. Compliance with these requirements provides a reasonable level of assurance that your use of this product in a residential environment will not result in harmful interference with other electronic devices. This equipment generates/uses radio frequencies and, if not installed and used according to the instructions found in the owner's manual, may cause interference harmful to the operation of other electronic devices. Compliance with FCC regulations does not guarantee that interference will not occur in all installations. If this product is found to be the source of interference, which can be determined by turning the unit "OFF" and "ON", please try to eliminate the problem by using one of the following measures:

Relocate either this product or the device that is being affected by the interference.

Utilize power outlets that are on different branch (circuit breaker or fuse) circuits or install AC line filter/s.

In the case of radio or TV interference, relocate/reorient the antenna. If the antenna lead-in is 300 ohm ribbon lead, change the lead-in to coaxial type cable.

If these corrective measures do not produce satisfactory results, please contact your local retailer authorized to distribute this type of product. If you can not locate the appropriate retailer, please contact Yamaha Electronics Corp., U.S.A. 6600 Orangethorpe Ave., Buena Park, CA90620.

We Want You Listening For A Lifetime

YAMAHA and the Electronic Industries Association's Consumer Electronics Group want you to get the most out of your equipment by playing it at a safe level. One that lets the sound come through loud and clear without annoying blaring or distortion – and, most importantly, without affecting your sensitive hearing. Since hearing damage from loud sounds is often undetectable until it is too late, YAMAHA and the Electronic Industries Association's Consumer Electronics Group recommend you avoid prolonged exposure to excessive volume levels.



CAUTION: READ THIS BEFORE OPERATING YOUR UNIT

- 1 To ensure the finest performance, please read this manual carefully. Keep it in a safe place for future reference.
- 2 Install your unit in a cool, dry, clean place – away from windows, heat sources, and too much vibration, dust, moisture or cold. Avoid sources of hum (transformers, motors). To prevent fire or electrical shock, do not expose to rain and water.
- 3 Do not operate the unit upside-down.
- 4 Never open the cabinet. If a foreign object drops into the set, contact your dealer.
- 5 Place the unit in a location with adequate air circulation. Do not interfere with its proper ventilation; this will cause the internal temperature to rise and may result in a failure.
- 6 Do not use force on switches, knobs or cords. When moving the set, first turn the unit off. Then gently disconnect the power plug and the cords connecting to other equipment. Never pull the cord itself.
- 7 Do not attempt to clean the unit with chemical solvents: this might damage the finish. Use a clean, dry cloth.
- 8 Be sure to read the "Troubleshooting" section on common operating errors before concluding that your unit is faulty.
- 9 Unplug the power cord from the wall outlet if the unit is not to be used for an extended period of time. To disconnect the cord, pull it out by grasping the plug. Never pull the cord itself.
- 10 To prevent lightning damage, pull out the power cord and remove the antenna cable during an electrical storm.
- 11 The general digital signals may interfere with other equipment such as tuners or receivers. Move the system farther away from such equipment if interference is observed.

NOTE:

Please check the copyright laws in your country before recording from records, compact discs, radio, etc. Recording of copyrighted material may infringe copyright laws.

CONTENTS

FEATURES	4	VARIOUS FUNCTIONS FOR KARAOKE PLAY	9
ACCESSORY	4	REMOTE CONTROL TRANSMITTER	11
CONNECTIONS	5	TROUBLESHOOTING	12
BASIC OPERATION	7	SPECIFICATIONS	12

FEATURES

- Six audio and three video inputs (LD, CD/CDG, AUX1, 2, TAPE and VCR) allow you to connect various audio/video components.
- Combination of two Echo controls gives various echo effects to voices through the microphones.
- Key Control function allows you to select the desired musical pitch. (± 3 notes, 13 steps)
- With Sound Multiplex sources, the volume of the original vocals and the music can be adjusted by using the MPX BALANCE control.
- Music Volume control simply balances your voices and the music by adjusting the music volume level.
- Vocal Aid function replaces original vocals with your voice when you sing.
- Four different settings (Ballad, Pops, Jazz and Rock) of the built-in DSS (Digital Super Surround) allow you to obtain a suitable vocal effect according to the music type.
- One Touch Karaoke cuts off the original vocals of general stereo sources, so they can be used as karaoke sources.
- Your karaoke performance can be recorded with a cassette deck connected to this unit.
- High-power built-in amplifier.

ACCESSORY

After unpacking, check that the following accessories are supplied.

Remote control transmitter

Batteries

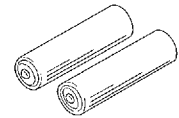
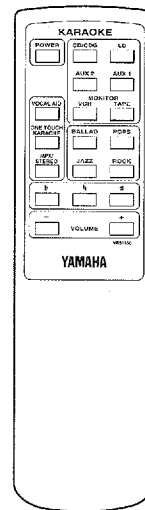

Reproducing karaoke sources with this unit

With a Sound Multiplex tape only for karaoke use or a sound multiplex disc (laser karaoke disc, etc.), generally, the right channel contains both background music and original vocals, and the left channel contains only background music.

Thus, these sources allow you to select only the background music, or to adjust the volume between original vocals and music by rotating the MPX BALANCE

control.

Note:

There are also other types of karaoke sources, with which the sound adjustments of this unit may not function properly. Please confirm of which type is the karaoke source you have purchased, before reproducing it with this unit.

CONNECTIONS

- Be sure to disconnect power cords of all the audio and video components from the AC outlets. Do not turn the power on until all connections are completed.
- When making connections between this unit and other components, make sure that all connections are correct, L (left) to L, R (right) to R.

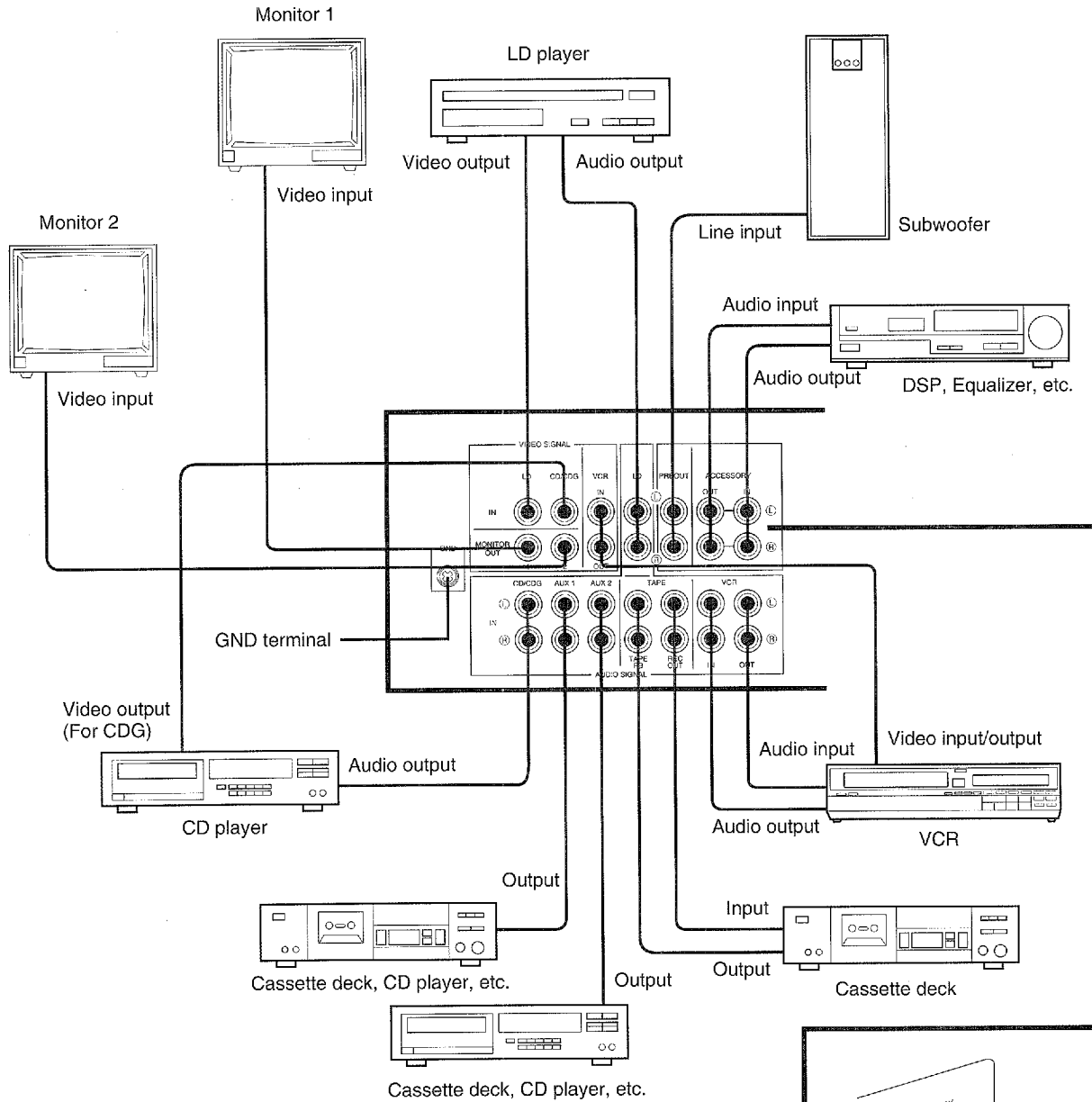

For powerful sound

To reproduce more powerful sound, connect the power amplifier instead of subwoofer to PRE OUT jacks, to drive the high-power speakers.

GND terminal

Usually, it is not necessary to make connection to this terminal. However, when excessive noise exists, connect the GND terminals of this unit and other components to minimize the noise.

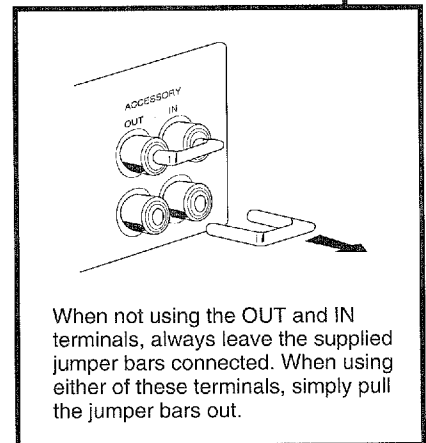

When not using the OUT and IN terminals, always leave the supplied jumper bars connected. When using either of these terminals, simply pull the jumper bars out.

Connecting speakers

One or two speaker systems can be connected to this unit. If you connect only one speaker system, connect it to either the SPEAKERS A or B terminals.

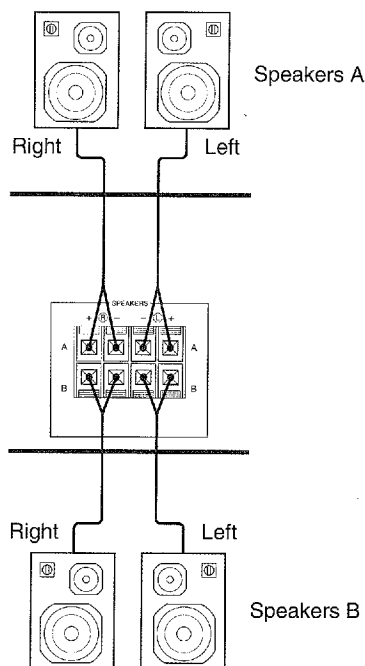

Connecting the AC OUTLETS

This unit is equipped with two SWITCHED AC OUTLETS for connecting the power cords of the components to this unit. The power to these outlets is controlled with this unit's POWER switch. When the power of this unit is turned off, the power supplied to the components connected to these outlets is also cut.

The total maximum power consumption of components connected to these outlets must not exceed 100 watts.

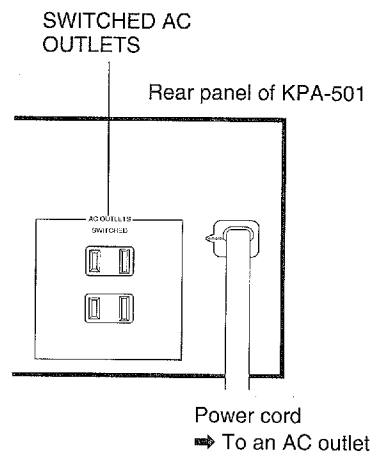

Note on speakers connections

Connect the SPEAKERS terminals to your speakers with wire of the proper gauge, cut to be as short as possible. If the connections are faulty, no sound will be heard from the speakers. Make sure that the polarity of the speaker wires is correct, that is, + and - markings are observed. If these wires are reversed, the sound will be unnatural and will lack bass. Do not let the bare speaker wires touch each other and do not let them touch the metal parts of this unit as this could damage this unit and/or speakers.

- Use speakers with the specified impedance shown on the rear panel of this unit.

- ① Raise (or press down) the tab.
- ② Insert the bare wire. [Remove approx. 5mm (1/4") insulation from the speaker wires.]
- ③ Press down (or raise) the tab to secure the wire.

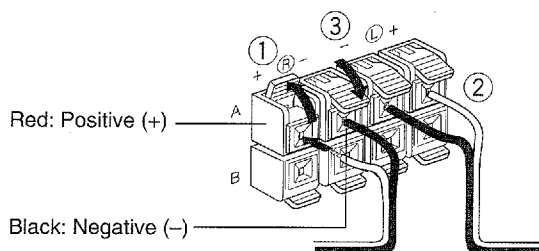

BASIC OPERATION

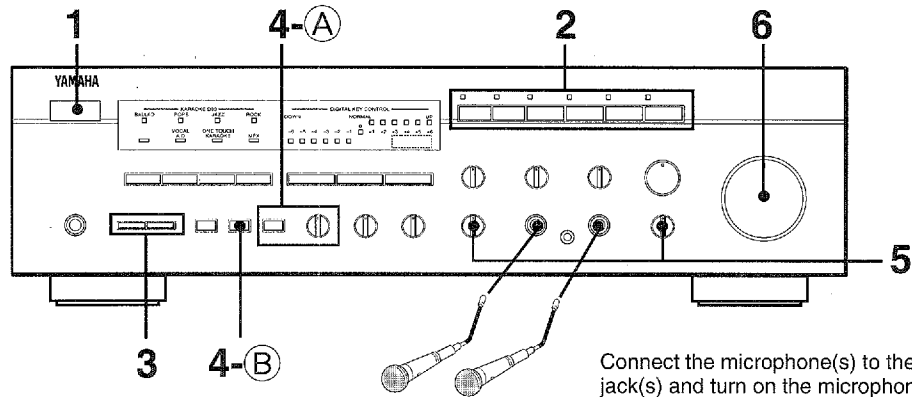

Connect the microphone(s) to the MIC jack(s) and turn on the microphone(s).

- 1** Turn on the power of this unit.

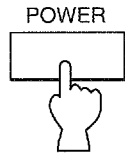

- 2** Select the source to be played with the INPUT selector and start playback.
(Adjust the VOLUME control to the appropriate level.)

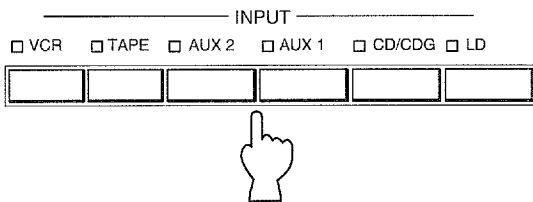

- 3** Select the speakers system by pressing the SPEAKERS A and/or B button.

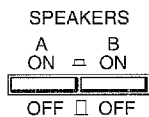

- 4** **(A)** When playing the sound multiplex source (sound multiplex karaoke disc or tape, etc.)

Press the MPX/STEREO button so that the MPX indicator lights.

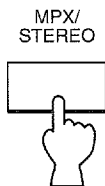

Adjust the MPX BALANCE control.

To decrease the volume level of the original vocals, turn the control toward "MUSIC".



- (B)** When playing a stereo source (general CDs, LDs or music tapes with vocals, etc.)
Make sure that the MPX/STEREO button is set to STEREO. (The MPX indicator goes off.)

Press the ONE TOUCH KARAOKE button so that the indicator lights.



The volume of the original vocals is reduced and the music is mainly heard.
With some discs, however, the original vocals may still be heard.

- 5** Adjust the microphone level with the LEVEL control(s) while speaking into the microphone(s).



- 6** Re-adjust the overall volume with the VOLUME control.

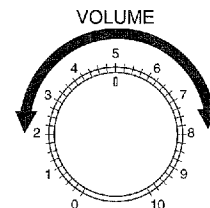

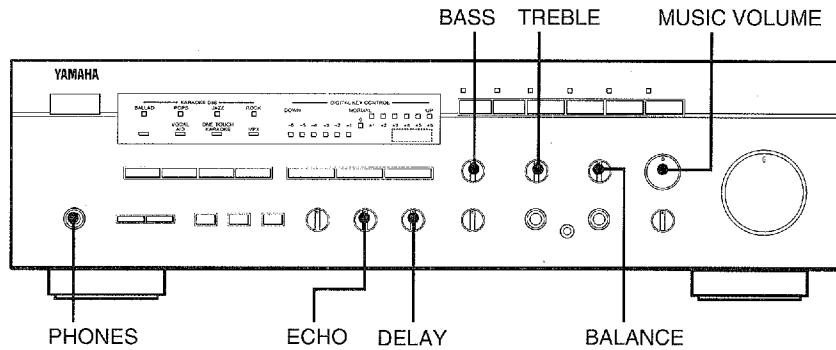

To adjust the balance between the left and right speakers

Turn the BALANCE control towards "R" to move the sound image to the right. To move the sound image to the left, turn the control towards "L".

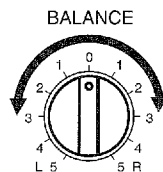

To adjust only the music volume

Turn the MUSIC VOLUME control towards "-20 dB" to decrease the volume level of the input sources other than the microphones.

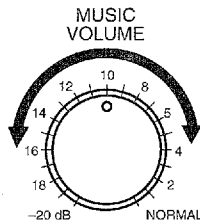

To adjust only the music tone

For high frequency sound

Turning the TREBLE control towards "+5" increases the high frequency sound levels, while turning the control towards "-5" decreases the levels.

For low frequency sound

Turning the BASS control towards "+5" increases the low frequency sound levels, while turning the control towards "-5" decreases the levels.

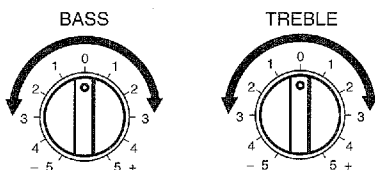

- If the sound is distorted by increasing the music tone level, turn down the MUSIC VOLUME control.
- The voices cannot be adjusted with these controls.

Adding the echo effect to your voice

The ECHO and DELAY controls are used to adjust the echo effect.

To adjust the echo level

Turning the ECHO control towards "10" increases the echo level, while turning the control towards "0" decreases it.

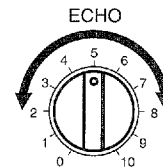

To adjust the echo length

Turning the DELAY control towards "10" expands the echo length, while turning the control towards "0" shortens it.

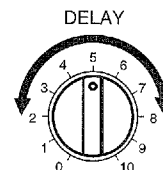

- The same echo effect is applied to the voices through both MICs 1 and 2.

When howling (a high-pitched sound) occurs

Separate the microphone farther away from the speakers, decrease the microphone level, or lower the overall volume level with the VOLUME control.

Notes on the microphone

When the microphone is not being used, turn off the microphone switch and unplug the microphone.

To use headphones

Insert the headphones plug into the PHONES jack.

STANDBY mode (Singapore model only)

While the power is on, pressing the POWER button on the remote control transmitter switches the unit to the STANDBY mode. (In this mode, the indicator is half-illuminated.)

VARIOUS FUNCTIONS FOR KARAOKE PLAY

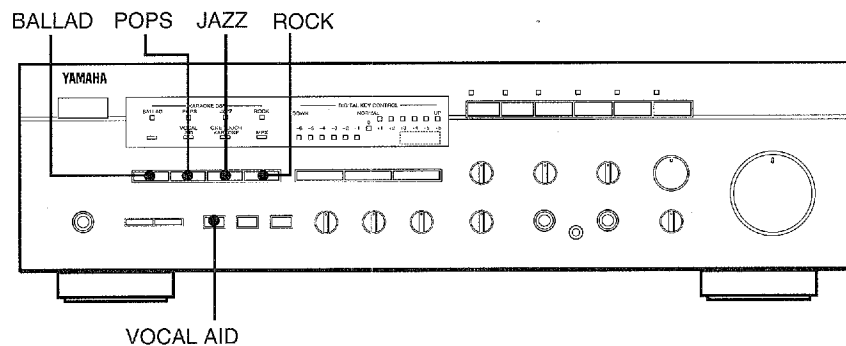

To replace original vocals with your voice only when you sing

Press the VOCAL AID button so that the indicator lights. When you sing into the microphone, your voice replaces the original vocals.

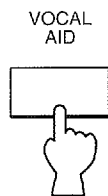

- When playing the sound multiplex sources with the MPX setting of the MPX/STEREO button, adjust the MPX BALANCE control to balance the volume between original vocals and music.

To obtain vocal effect according to the music type

Press one of the buttons to select the suitable effect for the music type you sing.

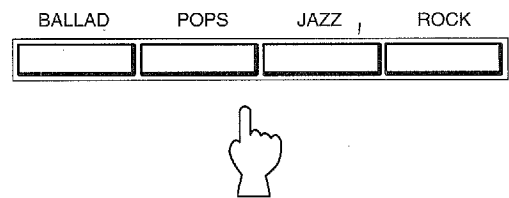

BALLAD: Suitable for mellow songs with slow-tempo; you can sing with expressions.

POPS: Suitable for pop music; you can sing with light-feelings.

JAZZ: Provides the reflections like in a small hall, which give an atmosphere similar to a jazz club.

ROCK: Suitable for dynamic and rhythmical rock sound.

Press the same button again to cancel the effect.

- This function has effect mainly on the sound through the microphone.

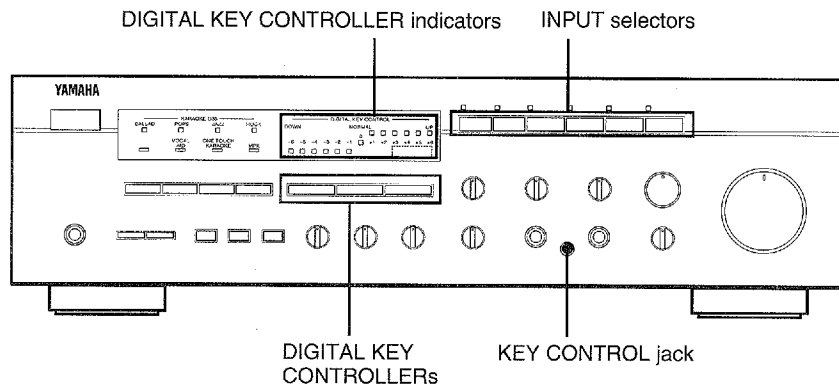

To obtain the desired musical pitch

Use the DIGITAL KEY CONTROLLERS to obtain the desired musical pitch (± 3 notes, 13 steps). The DIGITAL KEY CONTROLLER indicators (± 6 and NORMAL indicators) display the selected pitch.

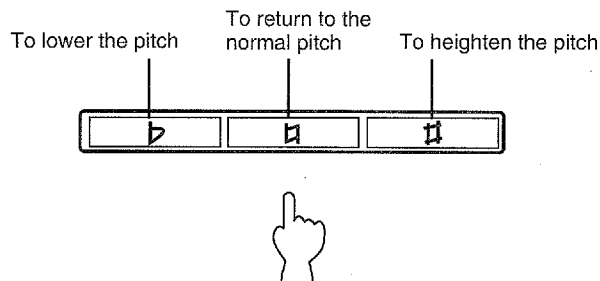

Controlling the musical pitch with microphone

It is also possible to control the musical pitch with the YAMAHA microphone provided with the key control plug (available in some areas). Connect the microphone to the MIC 1 or MIC 2 jack, and insert its key control plug in the KEY CONTROL jack next to the MIC jack.

NOTE:

If the input signal is interrupted for about 4 seconds, the setting will return to the normal pitch.

To record karaoke play

Karaoke play can be recorded with the cassette deck and/or VCR connected to this unit. Before recording, select the source to be played with the INPUT selectors. When recording with the cassette deck, select the source other than TAPE, and select the source other than VCR for the VCR recording.

NOTES:

- During playback of the cassette deck connected to TAPE PB jacks, the input signal to the TAPE PB jacks and the MIC jacks are not output from the REC OUT jacks. Thus, you cannot record these signals even if two cassette decks are connected to the TAPE PB jacks and REC OUT jacks respectively. Also, it is not possible to record with the VCR connected to the VCR OUT jacks during playback of the VCR source connected to the VCR IN jacks.
- The settings of BASS, TREBLE, KEY CONTROL, DSS (Digital Super Surround), etc. are reflected to the recorded sound. Therefore, the recorded sound will be similar to the sound output from the speakers.

To obtain the video output with the audio source

It is possible to obtain the video output even when one of the audio sources (AUX 1, 2 and TAPE) is selected as the input source.

Select an input source with video signal (LD, CD/CDG or VCR) and then switch to AUX1, 2 or TAPE. The audio signal is output accompanied with the video signal of the former-selected input source.

REMOTE CONTROL TRANSMITTER

With the remote control transmitter provided with this unit, you can operate the unit at your listening/singing position.

The buttons on the remote control transmitter have the same functions as those with the identical names on the main unit. For detailed instructions, refer to the descriptions on the corresponding buttons on the main unit.

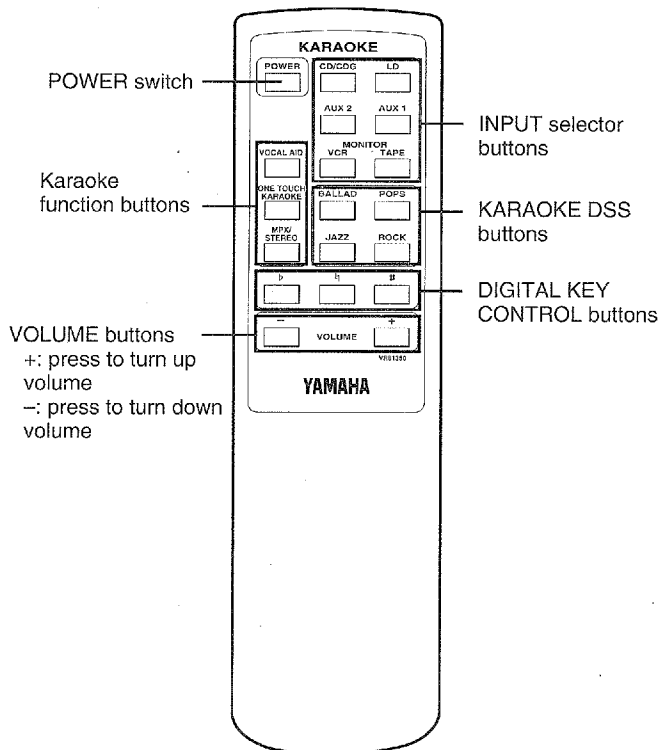

REMOTE CONTROL OPERATION RANGE

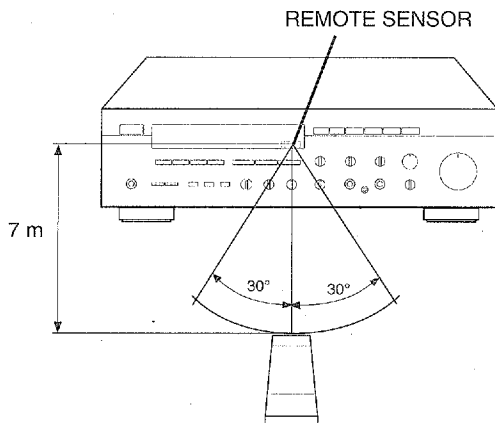

Battery installation

- ① Pull out the battery compartment lid in the direction of the arrow.
- ② Install the batteries (size AA, R6, UM-3) with correct polarities. Follow the diagram in the compartment.
- ③ Push the compartment lid in until it clicks into place.

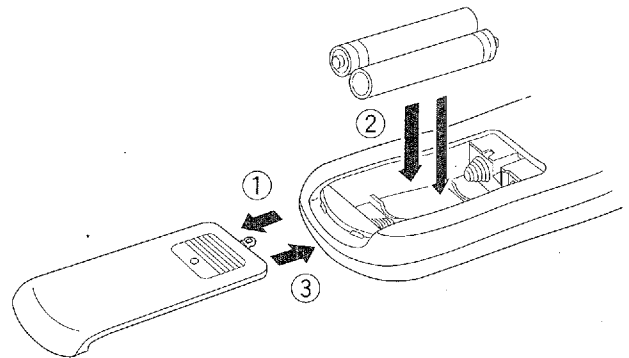

Battery replacement

If you find that the remote control transmitter must be used closer to the main unit, the batteries are weak. Replace both batteries with new ones.

Notes

- Use only AA, R6, UM-3 batteries for replacement.
- Be sure that the polarities are correct. (See the illustration inside the battery compartment.)
- Remove the batteries if the remote control transmitter will not be used for an extended period of time.
- If batteries leak, dispose of them immediately. Avoid touching the leaked material or letting it come in contact with clothing, etc. Clean the battery compartment thoroughly before installing new batteries.

TROUBLESHOOTING

If this unit fails to operate normally, check the following table. It lists common operating errors and simple measures which you can take to correct the problem. If it cannot be corrected, or the symptom is not listed, disconnect the unit's power cord and contact your authorized YAMAHA dealer or service center for help.

SYMPTOM	POSSIBLE CAUSE	REMEDY
Your voice is not heard through the microphone.	Microphone plug is not firmly inserted into the jack.	Insert firmly.
	Microphone is turned off.	Turn on the power of the microphone.
The volume of the original vocals cannot be reduced even when the MPX BALANCE control is turned to the MUSIC side.	The MPX/STEREO button is not set properly.	<ul style="list-style-type: none"> ● With sound multiplex sources, set the MPX/STEREO button to MPX. (The MPX indicator lights.) ● With general stereo sources, set the MPX/STEREO button to STEREO (the MPX indicator goes off) and press the ONE TOUCH KARAOKE button. The MPX BALANCE control does not function properly with these sources.
Your voice does not replace the original vocals even when the VOCAL AID button is pressed.	The volume level of the microphone is low.	Turn up the volume of the microphone with the MIC LEVEL control.
	The singing voice is not loud enough.	Sing louder.
The sound of the playback source is not heard.	The INPUT selector is not set properly.	Set it to the source to be played.
	Jumper bars are not firmly inserted into the ACCESSORY jacks.	Insert firmly.

- Sometimes the failure, e.g. when buttons do not function, may be remedied by disconnecting the AC power cord from the wall outlet and connecting it again, since the microcomputer inside the unit is reset through this procedure.

SPECIFICATIONS

Minimum RMS Output Power 65 W + 65 W
(0.05% THD, 20 Hz to 20 kHz, 6 ohms, both channels driven, input: ACCESSORY IN)

Rated Output Power (EIAJ) 80 W + 80 W
(1% THD, 1 kHz, 6 ohms, both channels driven, input: ACCESSORY IN)

Input Sensitivity/Impedance

MIC 0.5 mV/32 kohms
LD, CD/CDG, AUX1, 2, TAPE, VCR 150 mV/51 kohms
ACCESSORY IN 1.2 V/51 kohms

Rated Output Level/Impedance

REC OUT 150 mV/1.1 kohms
VCR OUT 150 mV/1.1 kohms
PRE OUT 1.2 V/1.1 kohms
ACCESSORY OUT 1.2 V/1.1 kohms

Frequency Response (20 Hz to 20 kHz)

ACCESSORY IN 0±1.0 dB

Tone Control Characteristics

BASS (boost/cut) ±12 dB (100 Hz)
TREBLE (boost/cut) ±12 dB (10 kHz)

Video Input Level/Impedance 1 V_{p-p}/75 ohms

Video Output Level/Impedance 1 V_{p-p}/75 ohms

Power Supply AC 120 V, 60 Hz

Power Consumption 150 W

AC Outlet (2 Switched Outlets) 100 W

Dimensions (W x H x D) 435 x 126 x 298 mm
(17-1/8 x 4-15/16 x 11-3/4 inch.)

Weight 7.7 kg (17 lbs.)

Specifications are subject to change without notice.

YAMAHA

YAMAHA ELECTRONICS CORPORATION, USA 6660 ORANGETHORPE AVE., BUENA PARK, CALIF. 90620, U.S.A.
YAMAHA CANADA MUSIC LTD. 135 MILNER AVE., SCARBOROUGH, ONTARIO M1S 3R1, CANADA
YAMAHA ELECTRONIK EUROPA G.m.b.H. SIEMENSSTR. 22-34, D-2084 RELLINGEN BEI HAMBURG, F.R. OF GERMANY
YAMAHA ELECTRONIQUE FRANCE S.A. 17 RUE DES CAMPANULES, LOGNES 77321 MARNE LA VALLEE CEDEX 2 FRANCE
YAMAHA ELECTRONICS (UK) LTD. YAMAHA HOUSE, 200 RICKMANSWORTH ROAD WATFORD, HERTS WD1 7JS, ENGLAND
YAMAHA SCANDINAVIA A.B. J A WETTERGRENS GATA 1, BOX 30053, 400 43 VASTRA FRÖLUNDA, SWEDEN
YAMAHA MUSIC AUSTRALIA PTY. LTD. 17-33 MARKET ST., SOUTH MELBOURNE, 3205 VIC., AUSTRALIA