

YAMAHA PORTATONE PSR-5700

OWNER'S MANUAL

Advanced Features

BEDIENUNGSANLEITUNG

Programmieranleitung

MODE D'EMPLOI

Fonctions avancées

MANUAL DE INSTRUCCIONES

Características avanzadas

The PSR-5700 Advanced Features manual contains operating instructions for the instrument's more complex and advanced features. If you are yet familiar with PSR-5700's basic features and the way it works in general, we recommend that you go through the PSR-5700 Getting Started manual prior to attempting to use the features described in this manual.

Contents

The Sequencer	3	[F2] Reverb, Effect	35
■ Recording	3	1 REVERB TYPE	35
■ Deleting Tracks	5	2 REVERB DEPTH	35
■ Playback	6	3 EFFECT TYPE	36
■ Sequence Editing	7	4 EFFECT DEPTH	36
E1 CONDITION/REC TYPE	7	[F3] Controller & Key Velocity	37
E2 VOLUME	8	1 KEY VELOCITY	37
E3 TRACK COPY/MIX	9	2 FOOT SWITCH SELECT	37
E4 QUANTIZE	10	3 EXP. PEDAL SELECT	38
E5 DELETE ALL TRACKS	11	4 SUSTAIN PART SELECT	38
E6 INSERT ALL TRACKS	12	5 PITCH BEND SELECT	39
E7 ERASE	12	6 WHEEL SELECT	39
E8 REMOVE EVENT	13	[F4] Split Point, Interactive Accompaniment, & Super Style Play Mode	40
E9 NOTE SHIFT	14	1 SPLIT POINT	40
E10 SONG CLEAR	14	2 INTERACTIVE ACCOMP.	40
The Custom Accompaniment Programmer	15	3 SUPER STYLE PLAY MODE	41
■ Basic Programming Procedure	15	[F5] Disk	42
■ Using a Custom Accompaniment	18	■ The [TO DISK] Button	42
■ Custom Accompaniment Editing	19	■ The [FROM DISK] Button	44
1 CUSTOM ACCOMP. (Measure/Beat)	19	■ The [F5] DISK Functions	45
2 VOLUME	19	1 FROM DISK	45
3 FADER SELECT	20	2 TO DISK	46
4 NAME	20	3 RENAME FILE	46
5 SAVE TO ACCOMP.	20	4 DELETE FILE	47
6 QUANTIZE	21	5 FORMAT DISK	47
7 COPY	22	6 DISK FREE AREA	47
8 REMOVE EVENT	23	• Disk Error Messages	48
9 CHANGE PATTERN	23	[F6] Utility & MIDI	49
• CREATING INTRO, FILL-IN, & ENDING PATTERNS	24	1 MEMORY BACKUP	49
• EXITING FROM THE CUSTOM ACCOMPANIMENT MODE	25	2 RECALL INITIAL DATA	50
Other Functions	26	■ The [DISK ORCHESTRA/GENERAL MIDI] Button	50
■ General Function Selection & Editing Procedure	26	3 MIDI CHANNEL SETTING	54
[F1] Custom Voice Edit	27	4 MULTI PART SETTING	56
■ Standard Voice Edit Functions (Voices 00 through 89)	27	5 MIDI SWITCH	56
1 NAME	27	6 MIDI SYSTEM	57
2 COMMON	28	7 DATA TRANSMIT	58
3 MODULATION	28	Index	59
4 EG RATE	29	MIDI Function Tree	242
5 TONE	30	MIDI Messages	246
■ Dual Voice Edit Functions (Voices 90 through 97)	30	DISK ORCHESTRA (DOC) Mode Voice List	253
1 DUAL NAME	30	GENERAL MIDI (GM) Mode Voice List	254
2 DUAL VOICE	31	PSR-5700 Percussion Map	255
3 DUAL OCTAVE	31	GM/DOC Mode Percussion Map	256
4 DUAL VOLUME	31	MIDI Implementation Chart	257
5 DUAL PAN	32	Specifications	258
6 DUAL DETUNE	32		
■ Drum Voice Edit Functions (Voices 98 and 99)	33		
1 PERC. NAME	33		
2 PERC. PITCH	33		
3 PERC. PAN	34		
4 PERC. TONE	34		

The Sequencer

The PSR-5700 features an 8-track sequencer that allows you to record and play back original musical creations — along with auto accompaniment if required. You can record the accompaniment and orchestra parts separately or at the same time. If, for example, you record the accompaniment first and then record your own performance while listening to playback of the accompaniment, you're free to use the entire keyboard for your performance rather than being limited to only the upper keyboard area. You can also play back each part independently or in any combination. For even further versatility, the PSR-5700 sequencer allows different songs to be saved to or re-loaded from floppy disk.

Recording

As you become more familiar with the PSR-5700 sequencer you'll probably develop a recording procedure that best suits your particular musical requirements. Here, to get you started, is the most simple, straightforward way to approach sequencer recording.

1 Engage the Sequencer

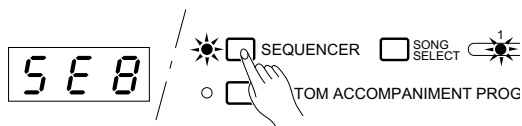

Press the [SEQUENCER] button to engage the sequencer. “SEQ” will appear on the TEMPO display if the currently selected song contains no data, or the measure number will appear if the song does contain data. The number-1 indicator to the right of the [SONG SELECT] button will also light.

If the sequencer contains previously recorded data, the green PLAY indicators of tracks containing data will light when the sequencer is engaged. Any of these tracks can be muted prior to engaging the record-ready mode (below) by pressing the corresponding track button so that the green PLAY indicator flashes.



The sequencer can also be engaged by pressing one of the track buttons, or by pressing the [SONG SELECT] button.

2 Select a Song Number

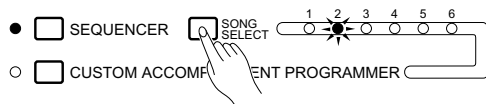

The PSR-5700 sequencer can record up to 6 separate songs. Use the [SONG SELECT] button to select the song number you want to record. The selected song number is shown by the indicators, 1 through 6, to the right of the [SONG SELECT] button.

3 Set Up All Record Parameters

Select the accompaniment style you want to record with, voices, orchestration, harmony, and other parameters before actually beginning recording. A list of the parameters that can be recorded by the PSR-5700 sequencer is given below.

You may also need to select a specific record mode and other conditions accessible via the sequencer's CONDITION/RECORD TYPE functions, described on page 7.

Recordable Parameters

Tracks 1 — 7

- Note on/off
- Pitch bend
- Modulation
- Sustain on/off
- Orchestra 1 & 2 volume
- Voice change (including custom voice on/off)
- Tempo (if ACCOMP. track contains no data)
- Glide on/off
- Percussion pad on/off*
- Tempo pad tempo value*
- Multi pad on/off (phrase only)*

* The pad mode selected when the sequence is played back will be used.

Accompaniment Track

- Chord & root (note on/off in Manual Bass mode)
- Style change (styles with the same time signature only)
- Rhythm volume
- Bass volume
- Chord 1 volume
- Chord 2 volume
- Tempo
- Reverb on/off & depth
- Reverb type
- Effect on/off & depth
- Effect type
- Effect control
- Harmony on/off and type
- Interactive Accompaniment on/off
- Interactive Accompaniment variation
- Interactive Accompaniment mode & sensitivity
- Auto Bass Chord mode
- Percussion Pad on/off
- Pad function (Multi/Tempo/Perc)
- Repeat/Synchro/Break on/off
- Manual bass on/off, voice
- Intro, fill in & ending
- Chord pad chord sequence
- Tempo pad tempo value



When the sequencer mode is engaged all previous panel settings are ignored.



If the record and playback pad modes are different, pad on/off events will not be reproduced.



If parameter changes are memorized using the Voice Registration, Panel Registration, or Super Styleplay features during recording, only those parameters that can be recorded on the current track will be memorized.



The time signature cannot be changed once a song has been recorded.

4 Select the Record Track(s)

AUTO BASS CHORD accompaniment can only be recorded on the ACCOMP. track. The ORCH.1 and ORCH.2 voices can be recorded on any of the remaining 7 tracks, but only one of these tracks can be recorded at a time if the normal ORCH.1 orchestration is selected. If the ORCH.2+1 or ORCH.2◀▶1 orchestration is selected, two record tracks must be selected — the ORCH.1 voice will be recorded on the lower-numbered track while the ORCH.2 voice will be recorded on the higher-numbered track. This means that a maximum of three record tracks can be specified when the ORCH.2+1 or ORCH.2◀▶1 orchestration is selected: ACCOMP. and any two numbered tracks.

To select the record track(s) and engage the record-ready mode, hold the [RECORD] button and press the appropriate track button(s). The red REC indicator for the tracks will flash. Also note that the AUTO BASS CHORD indicator will light automatically when the ACCOMP. track is selected.

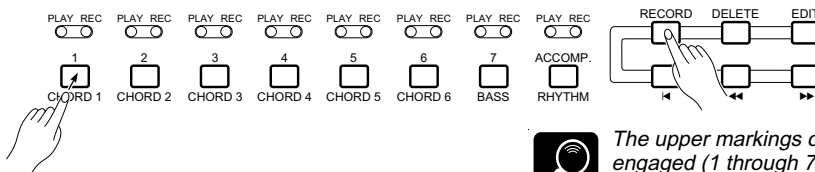

The upper markings on the track buttons apply when the SEQUENCER mode is engaged (1 through 7, and ACCOMP.). The lower markings when the CUSTOM ACCOMPANIMENT PROGRAMMER described on page 15 is operating.



If you are adding new material to tracks that have already been recorded, the [◀◀] and [▶▶] buttons can be used at this point to move to any measure number from which you want to begin recording. The [◀◀] and [▶▶] buttons will not function once recording has been started.

5 Start Recording

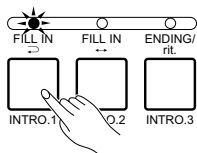
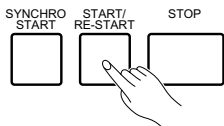

Recording will start as soon as the [START/RE-START] button is pressed or, if you also press the [SYNCHRO START] button, as soon as any key on the keyboard is pressed.

If the ACCOMP. track is selected and you start recording by pressing the [START/RE-START] button, only the rhythm will play until the first chord (FINGERED or SINGLE FINGER) is played on the left-hand section of the keyboard.

If you start recording in the SYNCHRO START mode by playing on the right-hand section of the keyboard, a metronome will sound in place of the rhythm and AUTO BASS CHORD accompaniment until a key is played on the left-hand section of the keyboard.



Before starting recording you can also choose an introduction by pressing any of the [INTRO.] buttons.



The restart function can not be used while the sequencer mode is engaged.



Previously recorded fill-ins may not always be erased if that section is re-recorded or deleted.

6 Play

Play the accompaniment and/or orchestra parts. The current measure number is shown on the TEMPO display as you record.

7 Stop Recording

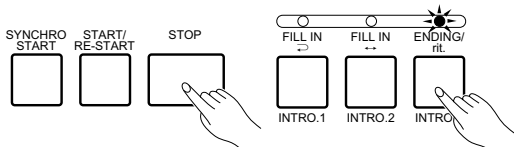

Press the [STOP] button to stop recording immediately, or the [ENDING/rit.] button to finish off the recording with an appropriate ending. The first measure of the sequence is automatically selected when recording is stopped.

8 Record a New Track

To record a new track, simply select a new voice and other parameters as required, select a new track as described in step 4, then record. All previously recorded tracks will automatically be set to the PLAY mode so you can record the new material while listening to the material you've already recorded. Repeat this procedure until your sequence is complete.



Up to approximately 7,000 notes can be recorded for all six sequencer songs. The exact number of notes that can be recorded, however, will depend on the type of data you record.

Deleting Tracks

If you make a mistake while recording or simply want to delete a track from your sequence, press the track button corresponding to the track you want to delete while holding the [DELETE] button.

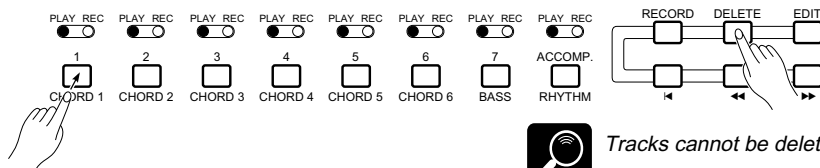

Tracks cannot be deleted during recording or playback.

Playback

1 Start Playback

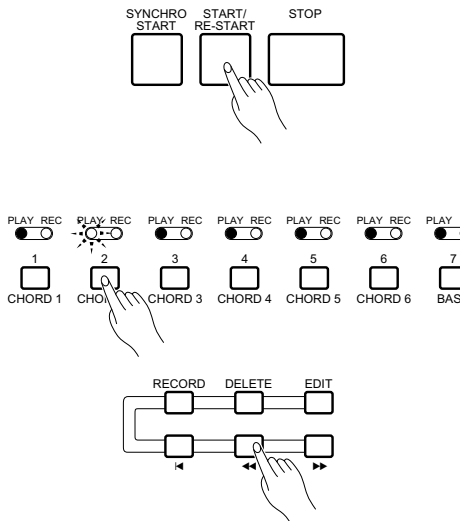

Since tracks are automatically set to the PLAY mode once they have been recorded, and tracks containing data are automatically set to the PLAY mode when the sequencer is initially engaged by pressing the [SEQUENCER] button, all you have to do to play back a sequence is to press the [START/RE-START] button. If you first press the [SYNCHRO START] button, sequencer playback can be started by playing any key on the keyboard.

Any of the PLAY tracks can be muted before or during playback by pressing the corresponding track button. The PLAY indicator will flash when a track is muted. Normal playback can be restored by pressing the track buttons of muted tracks a second time (the PLAY indicator will light continuously).



Before starting playback you can use the [◀◀] and [▶▶] buttons to move to any measure number from which you want to begin playback. The [▶] button goes directly to measure number 1.



If the Super Styleplay section change parameter (page 41) is turned ON during ACCOMP. track playback, the Super Styleplay section will change in accordance with accompaniment variation transitions and the result may be different from the recorded data.

2 Play along If You Like

You can play along with the sequence using the entire PSR-5700 keyboard, selecting different voices and changing the tempo as required (subsequently recorded tempo changes will still take effect).

Parameters That Can Be Changed During Playback

- Style select (styles with different time signatures cannot be selected)
- Volume (rhythm, bass, chord 1 & chord 2)
- Tempo
- Reverb & effect on/off
- Pad repeat and break on/off
- Interactive Accompaniment on/off & accompaniment variation (VERSE 1, VERSE 2, CHORUS 1, CHORUS 2, SOLO)
- Pad
- Some FUNCTION parameters (pages 26 through 58)



If changes to any of the above parameters are recorded in the sequence, the recorded changes will still take effect even if you manually change the parameters while playing.

3 Stop Playback

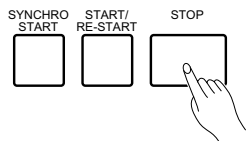

Playback will stop automatically when the end of the sequence is reached. At this point the parameters recorded on the ACCOMP. track will revert to their initial values. You can also stop playback at any time by pressing the [STOP] button.

4 Press [EXIT] When Done

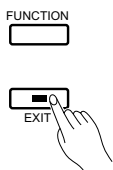

Press the [EXIT] key to exit the sequencer mode and return to the normal play mode. The sequencer mode can also be exited by pressing the [SEQUENCER] button.

Sequence Editing

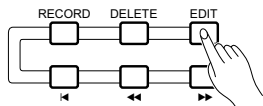

The PSR-5700 sequencer edit mode offers a range of functions that let you modify the recorded data and the way in which it is recorded in a number of ways.

Press the [EDIT] button while the sequencer is engaged to enter the sequencer edit mode. When you're finished editing press the [EDIT] button again or press the [EXIT] button to return to the sequencer.

The various functions in the sequencer edit mode are accessed by using the [▲] and [▼] buttons (these are the same as the [ABC MODE] and [HARMONY TYPE] buttons, respectively), while the various display screens provided by each function are accessed by using the [◀] and [▶] buttons (the [TRANSPOSE/TUNE] and [OCTAVE CHANGE] buttons, respectively).

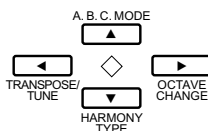
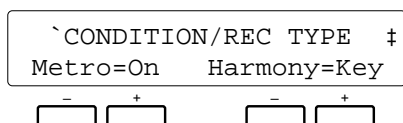

The sequencer record and playback modes can not be engaged while in the edit mode.



The edit functions may not work if a large amount of sequence data has been recorded.

E1 CONDITION/REC TYPE

Edit function 1 (“E1”) actually includes two separate functions: CONDITION and RECORD TYPE.

● Condition

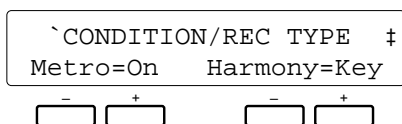

Purpose:

This display page allows the recording metronome sound to be turned on or off, and determines whether harmony will be applied to the keyboard or a track part.

Procedure:

Use the left [-] and [+] buttons to turn the metronome on or off, and the right [-] and [+] buttons to select the harmony part — “Key” or “Tr1” through “Tr7”.

Notes:

The metronome sound only appears during recording when no rhythm is playing.

When the “Key” harmony setting is selected (this is the default setting when the sequencer mode is engaged), harmony will be applied to notes played on the keyboard. If the “Tr1” harmony setting is selected, harmony will be applied to the track-1 part. If “Tr2” is selected harmony is applied to track 2, and so on.

If Harmony is not turned on during recording, it will automatically be turned off each time playback is stopped if it is turned on before or during playback.

Harmony can only be applied to tracks that contain data.

The Sequencer

● Recording Type

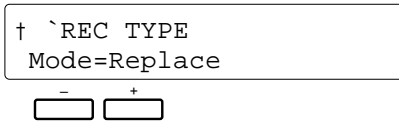

Purpose:

Selects the Replace, Overdub, or Punch record mode.

Procedure:

Press the [▶] button to access the REC TYPE display. Use the left [-] and [+] buttons to select the Replace, Overdub, or Punch record mode:

• Replace

If replace recording is selected, any previous data on the track being recorded will be erased and replaced by the new material.

• Overdub

If overdub recording is selected, previous material on that track will be retained and the new material will be added to it.

• Punch

Punch-in recording allows a specified measure or range of measures to be re-recorded (replaced) without affecting previously recorded material before and after the punch-in range.

When the Punch mode is selected you must also specify the measure from which playback is to begin prior to the “punch-in” point at which recording will actually begin (Play St), the punch-in measure from which recording is

to begin (In), and the punch-out measure at which recording is to end (Out). Use the [◀] and [▶] buttons to switch between these two display screens, and the associated [-] and [+] buttons to specify the required measure numbers.

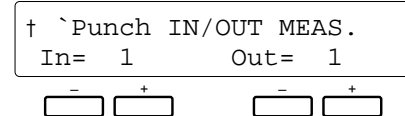
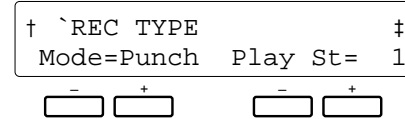

Notes:

It's generally convenient to set the “Play St” measure in the Punch mode to just a few measures before the punch-in point. This allows you to get the feel of the music and prepare to start playing at the punch-in point. You can even play along with the material prior to the actual punch-in point so you'll flow naturally into the punch-in recording range.

A footswitch (the supplied FC5 footswitch can be used) plugged into the rear-panel FOOT SW jack can also be used to punch-in and punch-out when the footswitch “Punch In” function is selected via the “FOOT SWITCH SELECT” function described on page 37. With the sequencer running in the Punch Record mode, press the footswitch at the point you want to begin recording (i.e. to “punch in”), and again to stop recording (punch out).

Please note that the punch-in record function can only be used on tracks that already contain recorded material.

E2 VOLUME

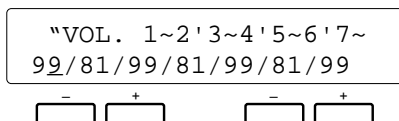

Purpose:

This page lets you independently set the playback volume of each of the sequencer's seven orchestra tracks.

Procedure:

Use the [◀] and [▶] buttons to position the cursor at the volume parameter of the track you want to adjust (1 through

7, from left to right), then use either the left or right [-] and [+] buttons to set the volume to a value between “00” (minimum volume — no sound) and “99” (maximum volume). Vertical bar-graphs to the right of each track number on the top line of the display provide a graphic representation of the track volume levels.

Notes:

Only tracks that contain data are available for volume control.

Any recorded volume changes will override these settings.

E3 TRACK COPY/MIX

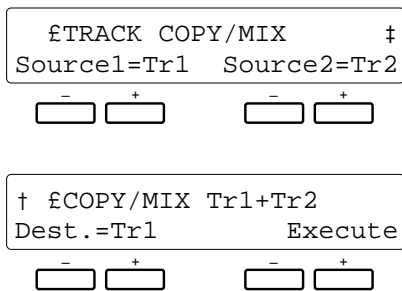

Purpose:

Copies the data from one recorded track to another, or mixes the data from two recorded tracks (except the ACCOMP. track).

● Copy

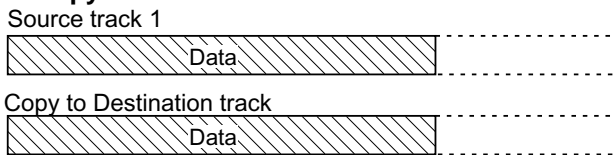

● Mix

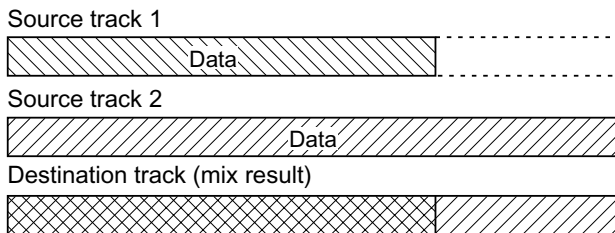

Procedure:

Use the [◀] and [▶] buttons to switch between the two display screens, and the left or right [-] and [+] buttons to set the first source track (Source1), the second source track (Source2), and the destination track (Dest.). If “CopyToDest.” is selected for the Source2 parameter, only the Source1 track is copied to the destination track.

Once the source and destination tracks have been selected, press the [+] button below “Execute” on the right side of the display to actually execute the mixdown operation. “Sequencer Executing!” will appear on the lower line of the display while the operation is in progress, and “Completed!” will appear briefly when the operation has finished.

Immediately after execution “Undo” will appear above the right [-] button, and that button can be used to undo the mixdown if it was executed by mistake. The undo function is only available until the next operation is performed.

Notes:

The mix function is most useful when you want to record more than 7 individual parts on the seven orchestra-part tracks. Successfully recorded parts can be combined using this function, thus opening up more tracks for further recording. The data in the source tracks is not erased during a mix operation.

If the tracks that are mixed use different voices, the voice of the lower-numbered track will be used. Subsequent recorded voice changes will operate normally.

Please note that only tracks containing data can be specified as the source tracks.

Any data in the destination track will be overwritten by data copied from the source 1 and 2 tracks.

E4 QUANTIZE

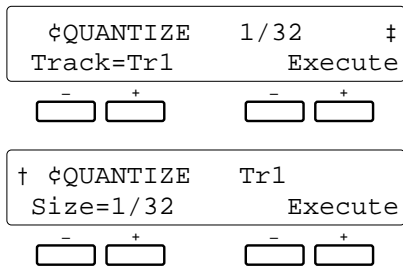

Purpose:

Aligns notes in the specified track to the nearest specified beat.

One measure of 8th notes before quantization



After quantization









Procedure:

Use the [◀] and [▶] buttons to switch between the two display screens, and the left [-] and [+] buttons to set the track number (Track) and the quantize size (Size).

Once the track number and quantize size have been selected, press the [+] button below “Execute” on the right side of the display to actually execute the quantize operation. “Sequencer Executing!” will appear on the lower line of the display while the operation is in progress, and “Completed!” will appear briefly when the operation has finished.

Immediately after execution “Undo” will appear above the right [-] button, and that button can be used to undo the quantize operation if it was executed by mistake. The undo function is only available until the next operation is performed.

The Quantize Sizes are:

- 1/4 = 1/4 note 
- 1/6 = 1/4 note triplet 
- 1/8 = 1/8 note 
- 1/12 = 1/8 note triplet 
- 1/16 = 1/16 note 
- 1/24 = 1/16 note triplet 
- 1/32 = 1/32 note 
- 1/96 = maximum resolution (default)

Notes:

Quantization is generally used to tighten up sloppy timing. Use it judiciously, however, because timing that is too perfect can sound cold and mechanical — unless, of course, you’re specifically aiming for a cold, mechanical feel. Always use a quantize value that is at least as “short” as the shortest notes in the track to be quantized. If you quantize a track containing 16th notes to 1/8 (8th notes), for example, some of the 16th notes will be aligned with 8th note beats, thus ruining the track.

E5 DELETE ALL TRACKS

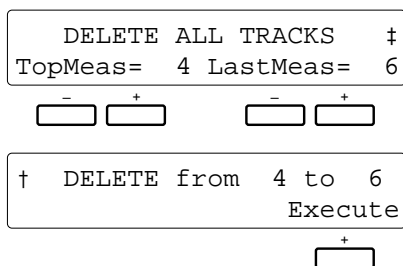

Purpose:

Deletes the specified measure or range of measures from all tracks (including the accompaniment track).

Delete Measures 4 through 6.

1	2	3	4	5	6	7	8	9
---	---	---	---	---	---	---	---	---

Measure 4 through 6 deleted.

1	2	3	←	7	8	9
---	---	---	---	---	---	---

Subsequent measures moved back.

1	2	3	4	5	6
---	---	---	---	---	---

Procedure:

Use the [◀] and [▶] buttons to switch between the two display screens, and the left or right [-] and [+] buttons in the first display screen to specify the number of the first measure in the range to be deleted (TopMeas) and the number of the last measure in the range to be deleted (LastMeas).

Once the top and last measure numbers have been selected, press the [+] button below “Execute” on the right side of the second display screen to actually execute the delete operation. “Sequencer Executing!” will appear on the lower line of the display while the operation is in progress, and “Completed!” will appear briefly when the operation has finished.

Notes:

It’s important to remember that a delete operation affects all tracks simultaneously, and that measures following the deleted range are moved back to take the place of the deleted measures. This differentiates the delete job from the erase job (described later), which replaces data in the specified range with rests.

Be careful when deleting measures that contain effect on/off events — e.g. pitch bend, modulation, sustain, harmony, etc. If, for example, you delete a measure that contains a pitch bend off event, the pitch bend applied in a previous measure will remain in effect until the next pitch bend event is encountered.

The delete operation has no “undo” function, so be absolutely sure you want to delete the selected material before actually executing the delete operation.

E6 INSERT ALL TRACKS

/INSERT ALL TRACKS †
 TopMeas= 6 Size= 3

-
+
-
+

† /INSERT from 6size 3
 Execute

+

Purpose:

Inserts a specified number of blank measures in all tracks (including the accompaniment track) at the specified measure number.

Insert measure, size 3, at measure 6.

1	2	3	4	5	6
---	---	---	---	---	---

Measure 6 moved up; 3 blank measures inserted.

1	2	3	4	5				6
---	---	---	---	---	--	--	--	---

Result with new measure numbers.

1	2	3	4	5	6	7	8	9
---	---	---	---	---	---	---	---	---

Procedure:

Use the [◀] and [▶] buttons to switch between the two display screens, and the left or right [-] and [+] buttons in the first display screen to specify the number of the measure at which the blank measures are to be inserted (TopMeas) and the number of blank measures to be inserted (Size).

Once the top measure number and size have been selected, press the [+] button below “Execute” on the right side of the second display screen to actually execute the insert operation. “Sequencer Executing!” will appear on the lower line of the display while the operation is in progress, and “Completed!” will appear briefly when the operation has finished.

Notes:

Insert affects all tracks simultaneously. The specified number of blank measures is inserted before the existing data beginning at the specified insert measure number.

The insert operation has no “undo” function.

E7 ERASE

fERASE †
 Track=Tr1 TopMeas= 4

-
+
-
+

† fERASE Tr1 from 4
 LastMeas= 6 Execute

+

Purpose:

Erases all note and event (pitch bend, volume changes, etc.) data from the specified measure or range of measures in the specified track (accompaniment track not available), leaving blank measures.

Erase measures 4 through 6.

TRACK 1

1	2	3	4	5	6	7	8	9
---	---	---	---	---	---	---	---	---



TRACK 1

1	2	3	4	5	6	7	8	9
---	---	---	---	---	---	---	---	---

Measures 4 — 6 “blank,”
containing only rests.

Procedure:

Use the [◀] and [▶] buttons to switch between the two display screens, and the left or right [-] and [+] buttons to set the track number (Track), the number of the first measure in the range to be erased (TopMeas), and the number of the last measure in the range to be erased (LastMeas).

Once the track and measure numbers have been selected, press the [+] button below “Execute” on the right side of the display to actually execute the erase operation. “Sequencer Executing!” will appear on the lower line of the display while the operation is in progress, and “Completed!” will appear briefly when the operation has finished.

Immediately after execution “Undo” will appear above the right [-] button, and that button can be used to undo the erase operation if it was executed by mistake. The undo function is only available until the next operation is performed.

Notes:

An erase operation leaves the specified measures intact but blank.

E8 REMOVE EVENT

¥REMOVE EVENT †	
Track=Tr1	Event=PB
- +	- +
□ □	□ □

† ¥REMOV Tr1 PB †	
TopMeas= 3	LastMeas= 4
- +	- +
□ □	□ □

† ¥REMOV Tr1 PB 3> 4	
Execute	
- +	
□ □	

Purpose:

Removes all occurrences of the specified event type (pitch bend, modulation wheel, volume, or sustain operations) from the specified measure or range of measures in the specified track (accompaniment track not available).

Procedure:

Use the [◀] and [▶] buttons to switch between the three display screens, and the left or right [-] and [+] buttons to set the track number (Track), the type of event to be removed (Event), the number of the first measure in the range from which the events are to be removed (TopMeas), and the number of the last measure in the range from which the events are to be removed (LastMeas).

Once the track, event, and measure numbers have been specified, press the [+] button below “Execute” on the right side of the display to actually execute the remove event operation. “Sequencer Executing!” will appear on the lower line of the display while the operation is in progress, and “Completed!” will appear briefly when the operation has finished.

Immediately after execution “Undo” will appear above the right [-] button, and that button can be used to undo the remove event operation if it was executed by mistake. The undo function is only available until the next operation is performed.

The Event Abbreviations are:

PB = Pitch Bend
 MOD = Modulation Wheel
 VOL = Volume
 SUS = Sustain
 VC = Voice Change

Notes:

This function is handy if, for example, you’ve played some wild pitch bends that don’t sound right. You can remove only the offending pitch bends without erasing the entire track.

Be careful when removing effect on/off events. If, for example, you remove a pitch bend off event in a specified measure, the pitch bend applied in a previous measure will remain in effect until the next pitch bend event is encountered. Similarly, if you remove all program change events from the beginning of a track, the voice that was initially selected when the track was recorded will be used.

E9 NOTE SHIFT

»NOTE SHIFT †	
Track=Tr1	Shift=+12
-	+
<input type="button" value="-"/>	<input type="button" value="+"/>

† »NOTE	Tr1	+12 †	
TopMeas=	1	LastMeas= 16	
-	+	-	+
<input type="button" value="-"/>	<input type="button" value="+"/>	<input type="button" value="-"/>	<input type="button" value="+"/>

† »NOTE	Tr1	1> 16	+12
Execute			
-	+		
<input type="button" value="-"/>	<input type="button" value="+"/>		

Purpose:

Shifts the pitch of notes in the specified measures of the specified track (accompaniment track not available) up or down by a maximum of two octaves, in semitone increments.

Procedure:

Use the [◀] and [▶] buttons to switch between the three display screens, and the left or right [-] and [+] buttons to set the track number (Track), the amount of note shift (Shift — see “Notes” below), the number of the first measure in the range in which the notes are to be shifted (TopMeas), and the number of the last measure in the range in which the notes are to be shifted (LastMeas).

Once the track, shift, and measure numbers have been specified, press the [+] button below “Execute” on the right side of the display to actually execute the note shift operation. “Sequencer Executing!” will appear on the lower line of the display while the operation is in progress, and “Completed!” will appear briefly when the operation has finished.

Immediately after execution “Undo” will appear above the right [-] button, and that button can be used to undo the note shift operation if it was executed by mistake. The undo function is only available until the next operation is performed.

Notes:

The range of “Shift” values is from -24 to +24. A setting of “0” produces no note shift. Each increment represents a semitone, so a setting of +4, for example, would shift the pitch of notes in the specified range up by an interval of a third. A setting of -12 would shift the notes down by one octave.

The ability to selectively shift the pitch of specified measures and tracks makes it simple to create “modulations” (key changes) without having to reprogram entire passages, and to create simple harmonies.

E10 SONG CLEAR

`...SONG 1 CLEAR	
FREE: 31k	Execute
	+
	<input type="button" value="+"/>

Purpose:

Deletes the entire song — i.e. deletes all data from all sequencer tracks.

Procedure:

Press the [+] button below “Execute” on the display to execute the song clear operation. “Completed!” will appear briefly when the operation has finished.

Notes:

Remember that this function deletes all data in the sequencer in one operation. If you think you might want to keep the data for later use or editing, be sure to save it to floppy disk (page 42, 46) before executing the song clear operation. Be careful with SONG CLEAR — it has no “undo” function!

The remaining amount of sequencer memory is shown on the bottom line of the display in kilobytes.

The Custom Accompaniment Programmer

The PSR-5700 CUSTOM ACCOMPANIMENT feature allows you to create and store up to six original accompaniments — including rhythm, bass, and chords — in addition to 36 internal preset accompaniment styles. You can even create intro, fill-in, and ending patterns that can be saved with your accompaniments. More custom accompaniments can be created and saved to floppy disk (page 42, 46). Your original accompaniments can be selected and played at any time, just like the presets.

Basic Programming Procedure

Although many of the steps outlined below do not have to be carried out in the order given, the basic programming procedure presented below will serve as useful guide to get you started.

1 Select a Suitable Accompaniment Style

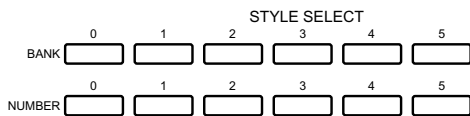

Begin by selecting one of the preset accompaniment styles that is close to the type of accompaniment you want to create. For example, select a WALTZ accompaniment style if you want to program a rhythm pattern in 3/4 time.

2 Engage the Custom Accompaniment Programmer

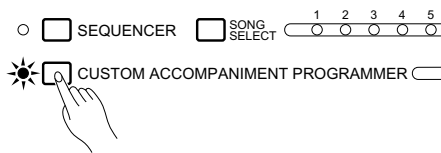

Press the [CUSTOM ACCOMPANIMENT PROGRAMMER] button. The selected accompaniment style will begin playing, with accompaniment based on a C major chord. Also, the rhythm track will be set to the record mode (red REC indicator lit) and the 98 DRUM KIT voice will be selected. All other tracks containing data will be set to the PLAY mode (green PLAY indicator lit). PLAY tracks can be muted by pressing the corresponding track button (the green PLAY indicator will flash when the track is muted).

3 Select an Accompaniment Variation

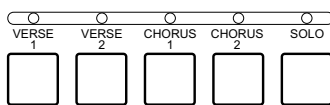

Use the [VERSE1], [VERSE2], [CHORUS1], [CHORUS2], and [SOLO] buttons to select the accompaniment variation you want to program (variations cannot be selected when a custom style is selected).

Intro, fill-in, and ending patterns will be based on the selected variation. If you delete all existing data to program an accompaniment from scratch, and change the time signature (beat), the intro, fill-in, and ending patterns cannot be used.

4 Program the Rhythm Part

Since the RHYTHM track is initially set to the REC mode and the 98 DRUM KIT voice is selected, you can start programming the RHYTHM track immediately.

You can add new notes to the rhythm by playing the keys corresponding to the PSR-5700 drums and percussion instruments. The drums and percussion instruments produced are indicated by the symbols immediately above the keys (see the “KEYBOARD PERCUSSION KEYS” chart on page 14 of the “Getting Started” manual). Please note that pitch bend can not be applied to the rhythm instruments.

The Custom Accompaniment Programmer

If you want to create a totally new rhythm track, press the RHYTHM track button while holding the [DELETE] button. This cancels all the instruments in the original rhythm track, leaving only a metronome sound (the metronome sound will not be heard while the rhythm is playing). The rhythm pattern can be up to 8 measures long (see “1. CUSTOM ACCOMP. Measure/Beat” on page 19), and the pattern will continue to repeat so you can add new instruments during each repeat, if necessary.

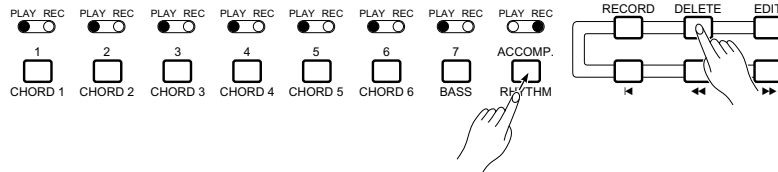

To Cancel A Single Percussion Instrument

Although you can cancel all instruments in the RHYTHM track by pressing the RHYTHM track button while holding the [DELETE] button, it is also possible to cancel a single instrument to eradicate a mistake or simply eliminate an unwanted instrument. While holding the CANCEL key (the highest key on the PSR-5700 keyboard), press the percussion key corresponding to the instrument you want to cancel. The selected instrument should now be cleared from the pattern.

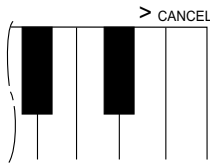

If you can't cancel an instrument even after following the above procedure, switch to VOICE SELECT number 8 or 9 and try again.

To Add Accents

To accent specific beats after recording the rhythm, press the accent key (the second to highest key on the keyboard, with the ">" symbol) at the timing of beats you want to accent.

5 Program the Bass and Chord Parts

After the RHYTHM track has been programmed (or it can be left as it is if no changes are required), you can select a bass or chord track for programming by pressing the BASS or a CHORD track button while holding the [RECORD] button (tracks containing preset data cannot be selected for recording). The RHYTHM track will automatically switch to the PLAY mode when a new REC track is specified. Please remember that only one track can be programmed at a time.

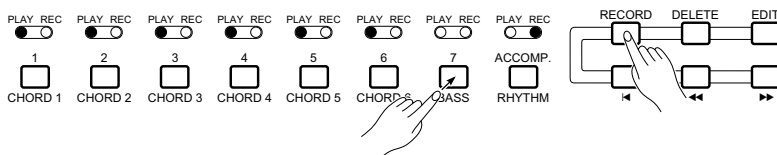

Play notes or chords to be added to the existing data, or delete all data on the track (press the track button while holding the [DELETE] button) and start from scratch. The bass and chord tracks must be programmed in the key of C major!

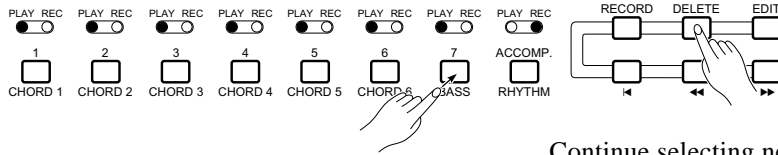

Continue selecting new record tracks and variations, and program until your custom accompaniment is complete.



Unwanted tracks can be deleted from the accompaniment by holding the [DELETE] button and pressing the appropriate track button.



Although the bass and chord tracks must be programmed in C major, they are automatically re-harmonized when the custom accompaniment is used in the play mode, and can be used in any key, major or minor.



When programming an accompaniment from scratch, you can select a new voice that will take effect from the beginning of the accompaniment after deleting all tracks. Other voice changes added while programming will take effect from the point at which they are made.



The synchro start, start, and stop functions can be used when recording a custom accompaniment. The re-start function, however, cannot be used.



Pitch bend, modulation, and sustain changes are not recorded if the accompaniment is stopped — the accompaniment must be running for parameter changes to be recorded.



The Custom Accompaniment Programmer memory capacity is limited. When the available memory for the track you are recording is exhausted, the "Work Area Full!!" display will appear and further recording on that track will be impossible unless existing data is deleted. Further, if the data size is too big when you perform a save operation, "Memory Area Full!!/ Can not Save" will appear on the display.



Only preset voices 00 through 89 can be used to record bass and chord parts (custom voices cannot be used).

Work Area Full !!

Memory Area Full!!
Can not Save

6 Set a New Default Tempo

If necessary, set a new default tempo for the custom accompaniment by using the TEMPO [-] and [+] buttons.

The Custom Accompaniment Programmer

7 Give the Finished Accompaniment a Name and Assign it to a CUSTOM Number

φNAME Big Band

-	+	-	+
---	---	---	---

SAVE TO ACCOMP. Set to=Cus0 -Execute-

-	+	-	+
---	---	---	---

SAVE ⌘Cancel Set to=Cus0 No Yes

-	+	-	+
---	---	---	---

Use the “4. NAME” function described on page 20 to give your custom accompaniment an original name, then use the “5. SAVE TO ACCOMP.” function described on page 20 to assign the accompaniment to a CUSTOM number and exit from the Custom Accompaniment Programmer mode.



Please note that if you attempt to exit from the Custom Accompaniment Programmer by pressing the [EXIT], [SEQUENCER], or [CUSTOM ACCOMP PROGRAMMER] button, the confirmation display shown to the left will appear:

Use the left [-] and [+] buttons to select the custom accompaniment number to which the accompaniment is to be stored (C0 through C5), then press the [+] button under “YES” on the display to store the accompaniment. Press the [-] button under “NO” on the display to exit from the Custom Accompaniment Programmer without storing the data. You can also press both the [-] and [+] buttons simultaneously to cancel the store operation and return to the Custom Accompaniment Programmer if you want to make a few more changes or additions to the accompaniment before storing.

Using a Custom Accompaniment

Once created and stored, your original accompaniment can be selected and used in the same way as the preset accompaniment styles.

Press the [CUSTOM] button and then the appropriate STYLE SELECT NUMBER button (0 through 5) to select a custom accompaniment — C0, C1, C2, C3, C4, or C5. The selected custom accompaniment can then be operated just like any of the preset accompaniment styles — it can be started and stopped as usual, and can be used in the FINGERED or SINGLE FINGER AUTO BASS CHORD modes.



To select a preset accompaniment style after selecting a custom accompaniment, use the STYLE SELECT buttons in the normal way.



Interactive Accompaniment cannot be used with custom accompaniments.

	STYLE SELECT						
BANK	0	1	2	3	4	5	CUSTOM
NUMBER	0	1	2	3	4	5	DIS

Custom Accompaniment Editing

The PSR-5700 Custom Accompaniment Programmer offers a range of functions that let you modify the recorded data in a number of ways. The various Custom Accompaniment Programmer functions are accessed by using the [▲] and [▼] buttons, while the various display screens provided by each function are accessed by using the [◀] and [▶] buttons.

1 CUSTOM ACCOMP. (Measure/Beat)

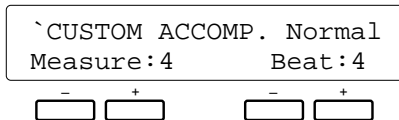

Purpose:

This display page allows the length (in measures) and time signature of the accompaniment to be defined when the Custom Accompaniment mode is initially engaged.

Procedure:

Use the left [-] and [+] buttons to specify the numbers of measures the accompaniment is to have (from 1 to 8), and the right [-] and [+] buttons to specify the number of beats per measure — from “3” to “5”.

Notes:

These parameters can only be changed when you’re creating an entirely new pattern from scratch — i.e. you have deleted all tracks from the original accompaniment by holding the [DELETE] button and pressing the buttons of all tracks containing data so that no PLAY indicators remain lit. The INTRO, FILL, and ENDING variations must also be empty.

FILL patterns can have a maximum length of 1 measure.

2 VOLUME

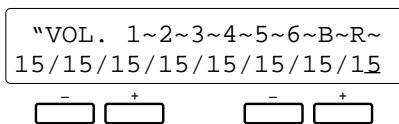

Purpose:

This page lets you independently set the volume of each of the Custom Accompaniment Programmer’s tracks.

Procedure:

Use the [◀] and [▶] buttons to position the cursor at the volume parameter of the track you want to adjust (1 through 6, “B” for BASS, and “R” for RHYTHM, from left to right), then use either the left or right [-] and [+] buttons to set the volume to a value between “0” (minimum volume — no sound) and “15” (maximum volume). Vertical bar-graphs to the right of each track number on the top line of the display provide a graphic representation of the track volume levels.

Notes:

Only tracks that contain data are available for volume control.

The Custom Accompaniment Programmer

3 FADER SELECT

```
£FADER SELECT
C1= C2` C3` C4" C5" C6"
  -   +   -   +
  [ ] [ ] [ ] [ ]
```

Purpose:

Assigns the CHORD 1 and CHORD 2 volume controls to Custom Accompaniment Programmer CHORD tracks 1 through 6, determining which control affects which chord tracks when the accompaniment is played back.

Procedure:

Use the [◀] and [▶] buttons to position the cursor at the chord track you want to assign (C1 through C6), then use the left or right [-] and [+] buttons to assign either “1” (the CHORD 1 volume control) or “2” (the CHORD 2 volume control) to the selected chord track.

Notes:

It is a good idea to group the chord tracks according to their musical function. For example, tracks containing basic block chords could be assigned to the CHORD 1 control while tracks containing more “decorative” chord work could be assigned to the CHORD 2 control.

4 NAME

```
¢NAME
  Big Band
  -   +   -   +
  [ ] [ ] [ ] [ ]
```

Purpose:

Allows a name of up to 8 characters to be assigned to the current custom accompaniment before it is stored via the following “5. SAVE TO ACCOMP.” function.

Procedure:

Use the [◀] and [▶] buttons to move the underline cursor to the various character positions, then use the left [-] and [+] buttons to select the required character for each position.

Notes:

Independent names can not be assigned to INTRO, FILL, and ENDING patterns. Here’s a list of the characters that can be selected via the left [-] and [+] buttons.

Character list

```
[Space]! " # $ % & ' ( ) * + , - . / 0 1 2 3 4 5 6 7 8 9 : ; < = > ? @
ABCDEFGHIJKLMNOPQRSTUVWXYZ [ \ ] ^ _ `
abcdefghijklmnopqrstuvwxyz { | } ≤ ≥
```

5 SAVE TO ACCOMP.

```
SAVE TO ACCOMP.
Set to=Cus0 -Execute-
  -   +   -   +
  [ ] [ ] [ ] [ ]
```

Purpose:

This function stores the current custom accompaniment to a specified custom accompaniment number.

Procedure:

The “Set to” parameter in the first display screen determines to which custom accompaniment number the accompaniment will be stored — Cus0, Cus1, Cus2, Cus3, Cus4, or Cus5. When the “Set to” parameter has been set as required by using the left [-] and [+] buttons, press the right [-] and [+] buttons under “-Execute-” on the display to actually store the current custom accompaniment in the specified custom accompaniment number. “Completed” will appear when the operation is complete.

6 QUANTIZE

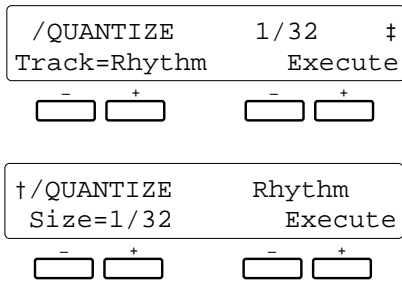

Purpose:

Aligns notes in the specified track to the nearest specified beat.

One measure of 8th notes before quantization



After quantization



Procedure:

Use the [◀] and [▶] buttons to switch between the two display screens, and the left [-] and [+] buttons to set the track number (Track) and the quantize size (Size).

Once the track number and quantize size have been selected, press the [+] button below “Execute” on the right side of the display to actually execute the quantize operation.

Immediately after execution “Undo” will appear above the right [-] button, and that button can be used to undo the quantize operation if it was executed by mistake. The undo function is only available until the next operation is performed.

The Quantize Sizes are:

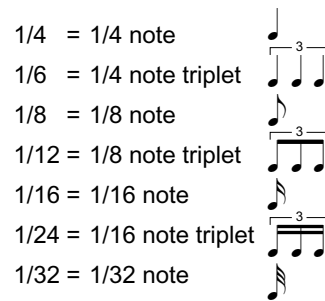

Notes:

Quantization is generally used to tighten up sloppy timing. Use it judiciously, however, because timing that is too perfect can sound cold and mechanical — unless, of course, you’re specifically aiming for a cold, mechanical feel. Always use a quantize value that is at least as “short” as the shortest notes in the track to be quantized. If you quantize a track containing 16th notes to 1/8 (8th notes), for example, some of the 16th notes will be aligned with 8th note beats, thus ruining the track.

Quantization can not be applied to tracks containing preset data. If you attempt to quantize a track containing preset (including disk style) data, “!” will appear on the display in place of “=”.

7 COPY

fCOPY	‡
Track=Rhythm	TopMeas=1
- +	- +

†fCOPY	‡
Rhythm 1-	
LastMeas=2	Meas=5
- +	- +

†fCOPY	‡
Rhythm 1-2>5	
Execute	
- +	

Purpose:

Copies a specified measure or range of measures to a different location within the same track.

Copy measures 1 through 2 to measure 5 in the same track.

1	2	3	4	5	6	7	8
---	---	---	---	---	---	---	---

1	2	3	4	1	2	7	8
---	---	---	---	---	---	---	---

Procedure:

Use the [◀] and [▶] buttons to switch between the three display screens, and the left or right [-] and [+] buttons in the various screens to specify the track number (Track), the number of the first measure of the range to be copied (TopMeas), the number of last measure of the range to be copied (LastMeas), and the number of the measure (Meas) to which the data is to be copied.

Once the track numbers and measure numbers have been selected, press the [+] button below “Execute” on the right side of the third display screen to actually execute the copy operation.

Immediately after execution “Undo” will appear above the right [-] button, and that button can be used to undo the copy operation if it was executed by mistake. The undo function is only available until the next operation is performed.

Notes:

A copy operation overwrites the data from the beginning of the specified destination measure with the data from the source measure(s). Previous data in the overwritten measures is therefore lost.

The COPY function cannot be used with tracks containing preset data.

8 REMOVE EVENT

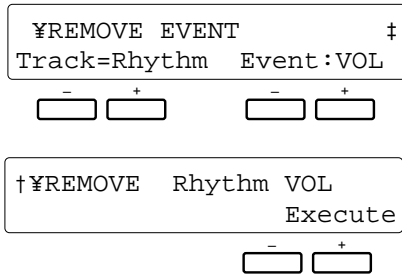

Purpose:

Removes all occurrences of the specified event type (volume, sustain, pitch bend, or modulation wheel operations) from the specified track.

Procedure:

Use the [◀] and [▶] buttons to switch between the two display screens, and the left or right [-] and [+] buttons to set the track number (Track) and the type of event to be removed (Event).

Once the track and event have been specified, press the [+] button below “Execute” on the right side of the display to actually execute the remove event operation.

Immediately after execution “UndoExecute” will appear above the right [-] button, and that button can be used to undo the remove event operation if it was executed by mistake. The undo function is only available until the next operation is performed.

The Event Abbreviations are:

PB = Pitch Bend
 MOD = Modulation Wheel
 VOL = Volume
 SUS = Sustain

Notes:

This function is handy if, for example, you’ve played some wild pitch bends that don’t sound right. You can remove only the offending pitch bends without erasing the entire track.

Only the VOL event type can be selected when the RHYTHM tracks is selected.

Be careful when removing effect on/off events. If, for example, you remove a pitch bend off event in a specified measure, the pitch bend applied in a previous measure will remain in effect until the next pitch bend event is encountered.

The REMOVE EVENT function cannot be used with tracks containing preset data.

9 CHANGE PATTERN

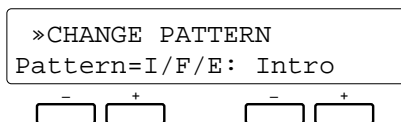

Purpose:

Selects the Normal or Intro/Fill/Ending accompaniment pattern for editing.

Procedure:

Use the left [-] and [+] buttons to select either “Normal” if you want to edit the normal accompaniment pattern, or “I/F/E” if you want to edit the INTRO, FILL or ENDING pattern. If you select “I/F/E”, the next step is to use the right [-] and [+] buttons to select “Intro”, “Fill” or “Ending”.

Once the desired pattern has been selected, go back to the preceding screens and create your custom accompaniment.

The Custom Accompaniment Programmer

● CREATING INTRO, FILL-IN, & ENDING PATTERNS

The custom accompaniment programmer allows you to create one set of intro, fill-in, and ending patterns that can be saved and later used with custom accompaniments Cus0 ... 5 (see “SET INTRO/FILL/ENDING” in step 7 for more details).

■ EDITING A PRESET INTRO, FILL-IN, OR ENDING PATTERN

1. Select the preset style that your custom accompaniment is to be based on.
2. Go to the “5 SAVE TO ACCOMP” screen and save the accompaniment to a custom accompaniment number (Cus0 ... 5).
3. Use the [CUSTOM] and [NUMBER] buttons to select the custom accompaniment you saved in the preceding step.
4. Go to the “9 CHANGE PATTERN” screen and use the left [-] and [+] buttons to select “I/F/E”, then use the right [-] and [+] buttons to select “Intro,” “FillIn,” or “Ending.”

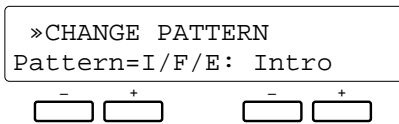

5. After selecting the type of pattern to be programmed, go to any other custom edit screen and program the pattern using the standard custom accompaniment programming procedure.
6. When the pattern is complete, go to the “5 SAVE TO ACCOMP” screen and save the pattern.



If you go to the “9 CHANGE PATTERN” screen and select a different “Pattern,” the screen you need to save the pattern you created in step 5 will appear automatically. Press the [+] button under “YES” on the display and the pattern will be saved.

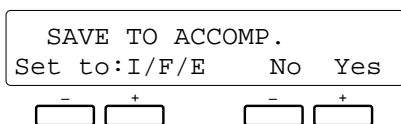

7. At this point the “SET INTRO/FILL/ENDING” screen will appear. Shift to the second screen and use the left and right [-] and [+] buttons to select “User” for the custom accompaniment numbers with which you want to use your original intro/fill/ending patterns.
Shift back to the first screen and press the [+] button under “RETURN” on the display to return to the “5 SAVE TO ACCOMP” screen.

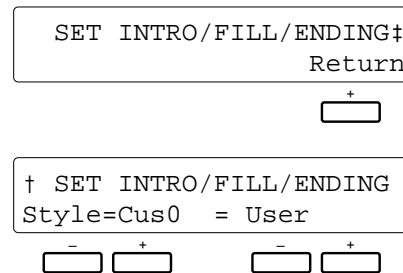

8. Repeat steps 4 through 7 to create other patterns.



If you select “Preset” in the “SET INTRO/FILL/ENDING” screen, then the un-edited intro, fill-in and ending patterns of the original preset style will be used with the selected custom style. If you select “NoAssign”, then no intro, fill-in, or ending patterns will be used. In this case the [INTRO] button functions in the same way as the [START] button, the [ENDING] button functions in the same way as the [STOP] button, and the [FILL IN] button has no effect.



If the user patterns have a different time signature than the custom accompaniment patterns, then “User” cannot be selected in the “SET INTRO/FILL/ENDING” screen.



The “SET INTRO/FILL/ENDING” screen appears automatically when an intro, fill-in, or ending pattern is saved, or when “I/F/E” is reset to “Normal” in the “9 CHANGE PATTERN” screen.



To prevent differences between the time signatures of the intro, fill-in, and ending patterns, all the patterns for the selected styles are saved simultaneously when any one pattern is saved. For example, if you edit an intro pattern while a preset style is selected and then save the intro pattern, the fill-in and ending patterns for the selected style will also be saved. If you then edit and save the fill-in pattern, the intro and ending patterns will also be saved, meaning the intro pattern you just saved will be overwritten. To prevent this, first copy the preset style to a custom style number, as described in steps 1 through 3, above, and then use this as a basis for your new patterns. Of course, you must be careful that you don’t overwrite a previously saved custom accompaniment style when doing this.

■ EDITING A PREVIOUSLY SAVED USER INTRO, FILL-IN, OR ENDING PATTERN

To edit intro, fill-in, and ending patterns that you have previously created and saved, simply select the custom accompaniment to which the user patterns are assigned (Cus0 ... 5) and follow steps 4 through 8, above.

■ CREATING A NEW INTRO, FILL-IN, OR ENDING PATTERN

After selecting an intro, fill-in, or ending pattern as described in step 4, above, use the [DELETE] button to delete all data from all tracks. Then follow steps 5 through 8 to create your original pattern.

To create an intro, fill-in, or ending pattern with a different time signature, go to the “1 CUSTOM ACCOMP” screen and set the “BEAT” parameter as required. If you delete and save the intro pattern, the fill-in pattern, and the ending pattern, the “1 CUSTOM ACCOMP” screen will appear automatically no matter what pattern edit mode you’re in, and you can set the “BEAT” parameter as required.



Use the synchro start function when you want to enter data precisely on the first beat of the first measure.

● EXITING FROM THE CUSTOM ACCOMPANIMENT MODE

To exit from the custom accompaniment mode, press either the [CUSTOM ACCOMPANIMENT PROGRAMMER] or [EXIT] button. This will return you to the normal play mode.

If you have not performed a save operation via the “5 SAVE TO ACCOMP” screen after performing any other operation in the custom accompaniment mode, however, the following display will appear automatically when you exit from the custom accompaniment mode:

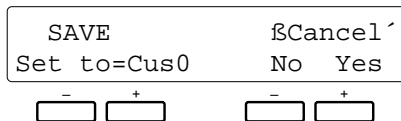

To save the edited data before exiting, use the left [-] and [+] buttons to select the destination custom accompaniment number, and then press the [+] button below “YES” on the display. If you want to exit without saving, simply press the [-] button below “NO” on the display.



You can return to the custom accompaniment mode by pressing both the right [-] and [+] buttons simultaneously.

If you attempt to exit after programming an intro, fill-in, or ending pattern, the following display will appear:

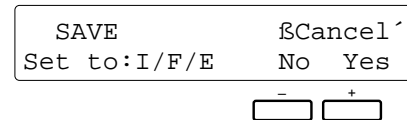

From this display you will exit to the “SET INTRO/FILL/ENDING” display, from which you can exit as described above.

Other Functions

The PSR-5700 [FUNCTION] button selects 6 groups of functions that access single or multiple display “pages” of parameters. Here’s a list of the functions and the manual page numbers on which they are described in detail.

[F1] Custom Voice Edit	27	[F4] Split Point	40
[F2] Reverb Type	35	Interactive Accompaniment.....	40
Effect Type	36	Super Style Play Mode	41
[F3] Controller	37	[F5] Disk	42
Key Velocity	37	[F6] Utility	49
		MIDI	50

General Function Selection & Editing Procedure

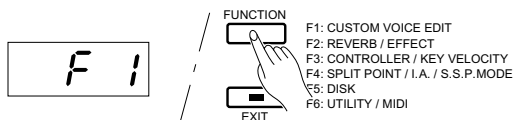

Each of the function groups selected by the [FUNCTION] button includes several display “pages.” These are accessed by using the [S] and [T] buttons. Furthermore, in some cases a display page have more parameters than fit in a single screen. The different screens are accessed by using the [<] and [>] buttons.

Each display screen will have a maximum of two parameters, and these can be adjusted by using the [-] and [+] buttons immediately below each parameter. Pressing both the [-] and [+] buttons simultaneously will generally set the “normal” value for the selected parameter.

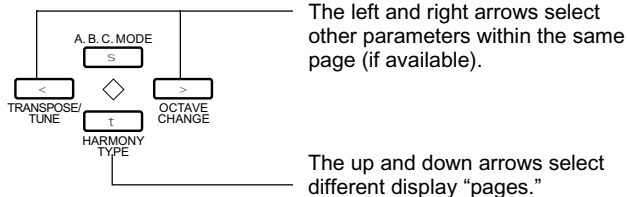
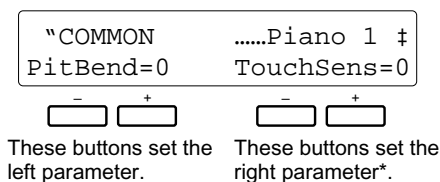

* Some functions have only one parameter which will be shown to the left of the display. In such cases the right [-] and [+] buttons will have no effect.

■ The [EXIT] Button

The [EXIT] button can be used at any time to exit from a function and return to the normal play mode.

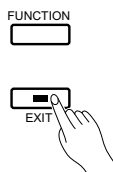

“Not Available in SEQ!” may appear on the lower display line when a function button is pressed in the sequencer, custom accompaniment programmer, DOC, or GM mode (depending on the mode, “SEQ” in the display may be replaced by “CUS”, “DOC”, or “GM”). If this message appears, the selected function cannot be accessed or edited.

[F1] Custom Voice Edit

The Custom Voice Edit mode allows you to edit any of the PSR-5700 voices to create new sounds that ideally match your own music style. 100 custom voices — 00 through 99 — can be programmed, each based on the correspondingly-numbered preset voice.

After selecting the voice you want to edit*, engage the Custom Voice Edit mode by pressing the [FUNCTION] button so that “F1” appears on the TEMPO display. Use the various editing functions described below to modify the sound to suit your needs. Then press the [EXIT] button when you’re finished editing to return to the normal play mode.

Your custom voices can be selected and played by pressing the [CUSTOM VOICE] button and using the VOICE SELECT buttons in the normal way (the custom voice numbers are displayed in reversed letters).

* You can also select a different voice while the Custom Voice Edit mode is engaged via the VOICE SELECT buttons. In this case the normal voice selection display will appear while the VOICE SELECT buttons are being used, and for a few seconds afterwards. The display will then revert to the previous Custom Voice Edit display page.



Please note that some voices may suddenly shift to a different octave or change in level when played on the highest or lowest keys. There may also be slight tonal changes at one or more points on the keyboard.



The preset value can be instantly recalled by pressing both the [-] and [+] buttons simultaneously.



Some settings may produce noise or no sound.

Standard Voice Edit Functions (Voices 00 through 89)

The following functions are available when editing voices 00 through 89. Different groups of edit functions are provided for the PSR-5700 dual voices (90 through 97 — page 30) and drum voices (98 and 99 — page 33).



For all parameters described here the preset value can be instantly recalled by pressing both the [-] and [+] buttons simultaneously.

1 NAME

NAME
.....:Piano 1
- +

Purpose:

Allows an 8-character name to be assigned to the voice.

Procedure:

Use the [<] and [>] buttons to position the cursor at the desired character location, then use the left [-] and [+] buttons to select the desired character. A chart of the available characters is given below.

Character list

[Space]! "#\$%&'()*+,-./0123456789:;<=>?@
ABCDEFGHIJKLMNOPQRSTUVWXYZ[\]^_`
abcdefghijklmnopqrstuvwxyz{|}~≤

Notes:

It’s a good idea to give your voices names that make them easily identifiable. If you’ve created a new voice that is a variation on the standard piano voice, for example, you could call it something like “PianVar”.

[F1] Custom Voice Edit

2 COMMON

COMMON includes two display screens covering a range of parameters that affect the entire voice.

Use the [$<$] and [$>$] buttons to switch between the two display screens, and the [$-$] and [$+$] buttons below each parameter to set the required values.

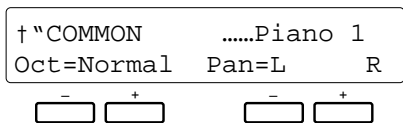
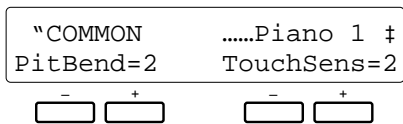

● Pitch Bend Range (PitBend)

Sets the range of the pitch bend wheel to “0” (OFF), “1” (± 1 semitone), “2” (± 2 semitones), “3” (± 3 semitones), or “Glis” (maximum 1-octave glissando in semitone steps).

● Touch Sensitivity (TouchSens)

Allows the touch sensitivity of the keyboard to be set to three different levels, or turned off: “0” (OFF), “1”, “2”, or “3”.

● Octave (Oct)

Shifts the pitch of the voice up one octave (1up) or down one octave (1down). A setting of “normal” produces the normal pitch for that voice.



Some voices may exhibit sudden pitch changes in the highest and lowest ranges of the keyboard when shifted up or down by an octave. The pitch bend wheel may also cause sudden pitch changes.

● Pan

Sets the apparent position of the voice in the stereo sound field. The graphic display indicates the approximate location of the sound between the left and right speakers.



When Pan is set to the center position, the preset pan position of the selected voice is used. The center pan position can be recalled immediately by pressing both the [$-$] and [$+$] buttons simultaneously.

3 MODULATION

The two parameters provided in this screen are used to adjust the depth and speed of modulation produced by the PSR-5700 MODULATION/EFFECT wheel.

Use the [$-$] and [$+$] buttons below each parameter to set the required values.

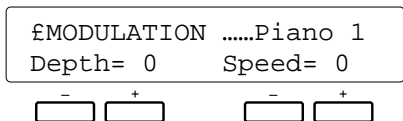

● Modulation Depth

Decreases ($-$) or increases ($+$) the depth of modulation produced by the PSR-5700 MODULATION/EFFECT wheel relative to the original modulation depth of the selected voice.

● Modulation Speed

Decreases ($-$) or increases ($+$) the speed of modulation produced by the MODULATION/EFFECT wheel relative to the original modulation speed of the selected voice.

Notes:

The maximum range of the depth and speed is from -7 through 0 to $+7$, although this range is more limited with some voices. An exclamation mark (!) will appear next to the parameter when the maximum or minimum allowable setting for the selected voice has been reached.

The default modulation depth and speed values for the selected voice are produced by settings of “0”. Minus settings produce gentler or slower modulation, while plus settings produce deeper or faster modulation, respectively. Pressing both the [$-$] and [$+$] buttons below a parameter immediately recalls the default value (“0”).

Modulation is applied automatically to some voices, and in some cases operating the wheel causes modulation to be applied automatically.

4 EG RATE

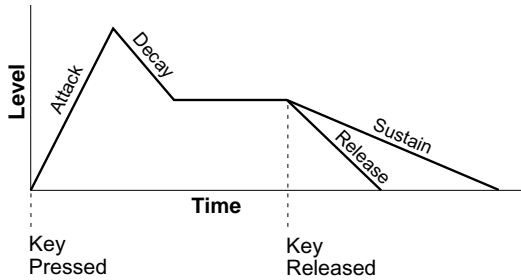

φEG RATEPiano 1 †
Attack= 0!	Decay= 0
-	+
-	+

†φEG RATEPiano 1
Release= 0	Sustain= 0
-	+
-	+

● Attack

Sets the speed of attack — i.e. how fast the sound reaches maximum level after a key is pressed.

“0” sets the normal attack for the selected voice, minus settings produce a slower attack, and plus settings produce a faster attack.

● Decay

Sets the speed of decay portion of the envelope — i.e. how fast the sound decays from the maximum attack level to its normal level.

“0” sets the normal decay for the selected voice, minus settings produce a slower decay, and plus settings produce a faster decay.

● Release

Sets the speed of release — i.e. how fast the sound decays after a key is released when the panel [SUSTAIN] button is off and the sustain pedal is not pressed.

“0” sets the normal release for the selected voice, minus settings produce a slower release decay, and plus settings produce a faster release decay.

The attack, decay, sustain, and release parameters provided here let you shape the volume envelope of the voice.

Use the [<] and [>] buttons to switch between the two display screens, and the [-] and [+] buttons below each parameter to set the required values.

● Sustain

Sets the speed of sustain decay — i.e. how fast the sound decays after a key is released when the panel [SUSTAIN] button is on or the sustain pedal is pressed.

“0” sets the normal sustain for the selected voice, minus settings produce a longer sustain decay, and plus settings produce a faster sustain decay.

Notes:

The maximum range for all parameters is from -50 through 0 to +50, although this range is more limited with some voices. An exclamation mark (!) will appear next to the parameter when the maximum or minimum allowable setting for the selected voice has been reached.

The default values for the selected voice are produced by settings of “0”. Pressing both the [-] and [+] buttons below a parameter immediately recalls the default value (“0”).



With voices like 21 STRINGS, in which key velocity (keyboard dynamics) controls the speed of attack, attack speed changes in the same way even if the attack parameter is set to a minus value.

Since PIANO 1 (00) and some other voices already have the fastest possible attack, no sound will be produced if the Decay parameter for such voices is set to “+50.”

The Decay parameter will have no effect on some sustain-type voices which have no inherent decay.



Changing the EG rate parameter may have no effect on the sound with some voices.

[F1] Custom Voice Edit

5 TONE

The brilliance and resonance parameters provided here make it possible to vary the tone of the voice over a wide range. Use the [-] and [+] buttons below each parameter to set the required values.

TONEPiano 1
Brilli= 0	Resonanc= 0!
<input type="button" value="-"/> <input type="button" value="+"/>	<input type="button" value="-"/> <input type="button" value="+"/>

● Brilliance (Brilli)

This parameter alters the cutoff frequency of the filter applied to the voice, thereby making the sound more or less brilliant. Minus settings reduce brilliance for a rounder, more mellow tone, while plus setting increase brilliance for a sharper tone.

● Resonance (Resonanc)

Plus settings increase the height of a resonant peak at the filter cutoff frequency, giving the voice greater presence and sometimes a more “nasal” tone. Minus settings reduce resonance for a “flatter” sound.

Notes:

The maximum range of both parameters is from -50 through 0 to +50, although this range is more limited with some voices. An exclamation mark (!) will appear next to the parameter when the maximum or minimum allowable setting for the selected voice has been reached.

The default values for the selected voice are produced by settings of “0”. Pressing both the [-] and [+] buttons below a parameter immediately recalls the default value (“0”).

Dual Voice Edit Functions (Voices 90 through 97)

The following functions are available when editing voices 90 through 97. Different groups of edit functions are provided for the PSR-5700 normal voices (00 through 89 — page 27) and drum voices (98 and 99 — page 33).



For all parameters described here the preset value can be instantly recalled by pressing both the [-] and [+] buttons simultaneously.

1 DUAL NAME

`DUAL NAME
»...:SpacePno
<input type="button" value="-"/> <input type="button" value="+"/>

Purpose:

Allows an 8-character name to be assigned to the custom dual voice.

Procedure:

Use the [<] and [>] buttons to position the cursor at the desired character location, then use the left [-] and [+] buttons to select the desired character. A chart of the available characters is given below.

Character list

[Space]! " # \$ % & ' () * + , - . / 0 1 2 3 4 5 6 7 8 9 : ; < = > ? @
A B C D E F G H I J K L M N O P Q R S T U V W X Y Z [\] ^ _ `
a b c d e f g h i j k l m n o p q r s t u v w x y z { | } ≤ ≥

Notes:

Give your dual voice names that identify both the voices used, if possible. If you’ve created a new dual voice that combines piano and organ, for example, you could call it something like “PianOrg”.

2 DUAL VOICE

"DUAL VOICE		»...SpacePno	
00:Piano 1	19:Voyager		
-	+	-	+
<input type="text"/>	<input type="text"/>	<input type="text"/>	<input type="text"/>

Purpose:

This function allows any two of the PSR-5700's standard voices (numbers 00 through 89) to be assigned to the dual voice.

Procedure:

Use the left and right [-] and [+] buttons to select the desired voices.

Notes:

Remember that you can only use voices 00 through 89 in a custom dual voice. If you increment past voice number 89, the next voice selected will be 00, and vice versa.

The pitch bend range for DUAL VOICE is limited to ± 1 whole tone.

3 DUAL OCTAVE

£DUAL OCTAVE		»...SpacePno	
A=1down	B=Normal		
-	+	-	+
<input type="text"/>	<input type="text"/>	<input type="text"/>	<input type="text"/>

Purpose:

Allows the two voices used in the dual voice to be independently shifted up or down one octave.

Procedure:

Use the left and right [-] and [+] buttons to set the desired octaves for voices A and B. A setting of "normal" produces the normal pitch for that voice. "1up" shifts the pitch up one octave, and "1down" shifts the pitch down one octave.

Notes:

Some voices may exhibit sudden pitch changes in the highest and lowest ranges of the keyboard when shifted up or down by an octave. The pitch bend wheel may also cause sudden pitch changes.

Previous OCTAVE settings for the normal voice will be ignored.

4 DUAL VOLUME

çDUAL VOLUME		»...SpacePno	
A=50!	B=45		
-	+	-	+
<input type="text"/>	<input type="text"/>	<input type="text"/>	<input type="text"/>

Purpose:

Independently adjusts the volumes of the two voices used in the dual voice.

Procedure:

Use the left and right [-] and [+] buttons to set the desired volume levels for voices A and B.

Notes:

The volume range is from "00" (no sound) to "50" (maximum volume). Use this function to set the optimum balance between the two voices.

When the parameter is set to "00" or "50" an exclamation mark (!) will appear next to the parameter indicating that the limit has been reached.

5 DUAL PAN

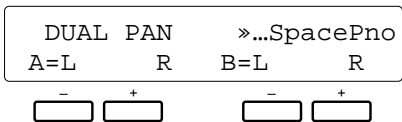

Purpose:

Independently sets the pan positions of the two voices used in the dual voice.

Procedure:

Use the left and right [-] and [+] buttons to set the desired pan positions for voices A and B. The graphic display indicates the approximate location of the sound between the left and right speakers.

Notes:

When Pan is set to the center position, the preset pan position of the selected voice is used. The center pan position can be instantly recalled by pressing both the [-] and [+] buttons simultaneously.

6 DUAL DETUNE

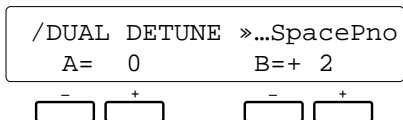

Purpose:

Allows the two voices used in the dual voice to be detuned slightly to create a thicker sound.

Procedure:

Use the left and right [-] and [+] buttons to set the desired detune for voices A and B.

Notes:

The normal tune value is “0”. This can be tuned down to a maximum setting of -50 or up to a maximum setting of +50. Each increment equals approximately 0.78 cents (a cent is one hundredth of a semitone). The maximum amount of detune that can be set in either direction is therefore 39 cents — not quite a quarter tone.

This function can be used by leaving one of the voices set at “0” and detuning the other until the desired effect is achieved. Another approach is to tune one voice down and the other up.

The pitch bend range is always ± 200 cents, regardless of the setting of this function.

When the parameter is set to “-50” or “50” an exclamation mark (!) will appear next to the parameter indicating that the limit has been reached.

Drum Voice Edit Functions (Voices 98 and 99)

The following functions are available when editing voices 98 and 99. Different groups of edit functions are provided for the PSR-5700 normal voices (00 through 89 — page 27) and dual voices (90 and 97 — page 30).

1 PERC. NAME

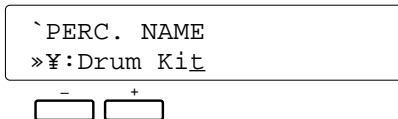

Purpose:

Allows an 8-character name to be assigned to the custom drum voice.

Procedure:

Use the [<] and [>] buttons to position the cursor at the desired character location, then use the left [-] and [+] buttons to select the desired character. A chart of the available characters is given below.

Character list

[Space]! "#\$%&'()*+,-./0123456789:;<=>?@
 ABCDEFGHIJKLMNOPQRSTUVWXYZ[\]^_`
 abcdefghijklmnopqrstuvwxyz{|}≤≥

Notes:

Give your drum voice names that identify their character. If you've created a new drum voice intended for rock music, for example, you could call it something like "RockDrum".

2 PERC. PITCH

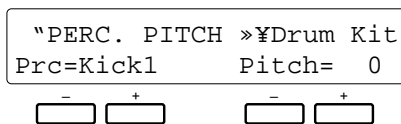

Purpose:

Allows the pitch of each instrument in the drum voice to be individually tuned.

Procedure:

Use left [-] and [+] buttons to select the instrument to be tuned, and then the right [-] and [+] buttons to set the desired degree of tuning.

Notes:

The maximum tuning range is from -50 through 0 to +50, with "0" being the normal pitch for the instrument. Each increment equals approximately 6.25 cents (a cent is one hundredth of a semitone), for a total tuning range of about ±312 cents.

[F1] Custom Voice Edit

3 PERC. PAN

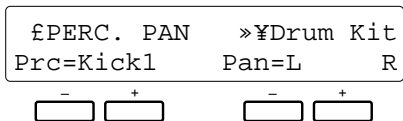

Purpose:

Allows the pan position of each instrument in the drum voice to be individually adjusted.

Procedure:

Use left [-] and [+] buttons to select the instrument to be panned, and then the right [-] and [+] buttons to set the desired pan position. The graphic display indicates the approximate location of the sound between the left and right speakers.

Notes:

Use this function to create the required “stereo image” for your drum voice. View in the drum kit from the audience side, for example, the bass drum is normally in the center, the snare to its right, the tom-toms to the left, and so on.

The center pan position can be instantly selected by pressing both the [-] and [+] buttons simultaneously.

When the parameter is set to “-50” or “50” an exclamation mark (!) will appear next to the parameter indicating that the limit has been reached.

4 PERC. TONE

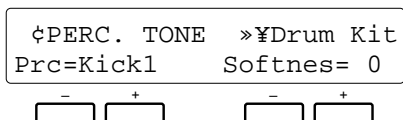

Purpose:

Allows the tone (softness) of each instrument in the drum voice to be individually adjusted.

Procedure:

Use left [-] and [+] buttons to select the instrument to be adjusted, and then the right [-] and [+] buttons to set the desired degree of softness.

Notes:

The “softness” setting range is from 0 through -9, with “0” being the normal setting for the selected instrument. Lowering the softness setting lowers the cutoff frequency of the filter applied to the selected drum instrument, thereby creating a softer tone.

Some voices may produce no sound if this parameter is set too low.

When the parameter is set to “0” or “-9” an exclamation mark (!) will appear next to the parameter indicating that the limit has been reached.

[F2] Reverb, Effect

The PSR-5700 has 23 reverb-based effects and 9 other effects that can be selected via the four pages accessed by this function. The selected reverb and effect types are applied to the sound when the [EFFECT] and [REVERB] buttons are used (see page 37 in the Getting Started manual).

1 REVERB TYPE

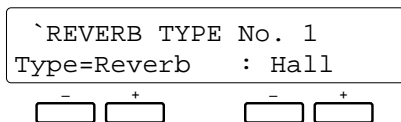

Purpose:

Selects the reverb effect to be applied when the [REVERB] button is turned on (see page 37 of the “Getting Started” manual).

Procedure:

The right [-] and [+] buttons step through the reverb list effect by effect. For faster selection you can use the left [-] and [+] buttons to directly select the reverb categories — Reverb, Delay, etc. — and then use the right [-] and [+] buttons to select the desired reverb effect within that category.

The Reverb Effects are:

- | | |
|----------------------|--------------------------|
| 1. Reverb : Hall | 13. TempoSync : Short |
| 2. Reverb : Room | 14. TempoSync : Long |
| 3. Reverb : Plate | 15. Echo : Stereo |
| 4. Reverb : Church | 16. Echo : PingPong |
| 5. Reverb : Club | 17. Refl&Gate : Panned |
| 6. Reverb : Stage | 18. Refl&Gate : Early |
| 7. Reverb : Bathroom | 19. Refl&Gate : Gate |
| 8. Reverb : Metal | 20. Delay&Rev : Single |
| 9. Delay : Short | 21. Delay&Rev : DelayL/R |
| 10. Delay : Medium | 22. Variation : Distort. |
| 11. Delay : Long | 23. Variation : Tunnel |
| 12. Delay : OneShot | |

Notes:

The “TempoSync” effects produce a delay that is synchronized to the currently selected tempo. “Variation : Distort” produces a distortion effect.

Try out all of the effects to get a feel for what they can do to your sound.

2 REVERB DEPTH

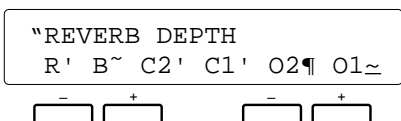

Purpose:

Independently sets the depth of the selected reverb effect for the rhythm, bass, chord 1, chord 2, orchestra 1, and orchestra 2 sound.

Procedure:

Use the [<] and [>] buttons to select the parameter for which reverb depth is to be adjusted (R = rhythm; B = bass; C1 = chord 1; C2 = chord 2; O1 = orchestra 1; O2 = orchestra 2), and use the [-] and [+] buttons to set the reverb depth for each parameter. Pressing the [-] and [+] buttons simultaneously instantly recalls the default depth value.

Notes:

Reverb depth can be adjusted in 7 steps, represented by a vertical bar to the right of each parameter. The longer the bar, the greater the reverb depth.

3 EFFECT TYPE

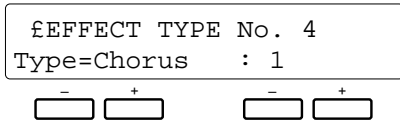

Purpose:

Selects the effect to be applied when the [EFFECT] button is turned on (see page 37 of the “Getting Started” manual).

Procedure:

The right [-] and [+] buttons step through the effect list effect by effect. For faster selection you can use the left [-] and [+] buttons to directly select the effect categories — Tremolo, Chorus, etc. — and then use the right [-] and [+] buttons to select the desired effect within that category.

The Effects are:

- 1. Tremolo : 1
- 2. Tremolo : 2
- 3. Tremolo : 3
- 4. Chorus : 1
- 5. Chorus : 2
- 6. Flange : 1
- 7. Flange : 2
- 8. Symphony : 1
- 9. Symphony : 2

Notes:

Try out all of the effects to get a feel for what they can do to your sound.

4 EFFECT DEPTH

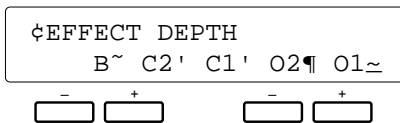

Purpose:

Independently sets the depth of the selected effect for the bass, chord 1, chord 2, orchestra 1, and orchestra 2 sound.

Procedure:

Use the [<] and [>] buttons to select the parameter for which effect depth is to be adjusted (B = bass; C1 = chord 1; C2 = chord 2; O1 = orchestra 1; O2 = orchestra 2), and use the [-] and [+] buttons to set the effect depth for each parameter. Pressing the [-] and [+] buttons simultaneously instantly recalls the default depth value.

Notes:

Effect depth can be adjusted in 7 steps, represented by a vertical bar to the right of each parameter. The longer the bar, the greater the effect depth.

[F3] Controller & Key Velocity

The [F3] function group includes six functions that affect how the PSR-5700 responds to control via the keyboard, a footswitch plugged into the rear-panel FOOT SW jack, an expression pedal plugged into the rear-panel EXP. PEDAL jack, the [SUSTAIN] button and SUSTAIN footswitch, the PITCH BEND/GLISSANDO wheel, and the MODULATION/EFFECT wheel.

1 KEY VELOCITY

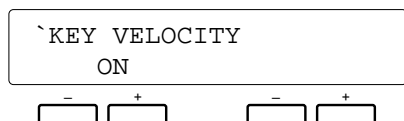

Purpose:

Turns keyboard velocity response on or off.

Procedure:

Use the left or right [-] and [+] keys to turn keyboard velocity response ON or OFF.

Notes:

This function should normally be turned ON so that you can create expressive dynamics by varying the velocity with which you play the keys (i.e. how hard you play the keys). Key velocity can be turned OFF when playing voices that normally don't have velocity response (organ, for example), or to assist young children learning to play the keyboard who have not yet developed the finger strength and touch for playing dynamics.

2 FOOT SWITCH SELECT

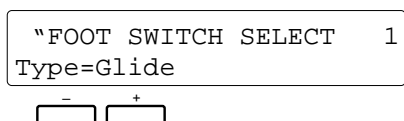

Purpose:

Determines the function of a footswitch plugged into the rear-panel FOOT SW jack.

Procedure:

Use the left [-] and [+] buttons to select one of the following footswitch functions:

- **Glide** Lower orchestra 1 sound by a semitone while footswitch pressed.
- **Harmony** Harmony occurs only while footswitch pressed.
- **Effect** Same as panel [EFFECT] button.
- **Punch In/Out** . Sets punch-in and punch-out points when sequencer record mode set to "Punch."
- **Tension** Modifies dominant 7th chords in the accompaniment to produce a more consistent sound when playing in a minor key. Also automatically re-harmonizes non-scale tones on chords other than the tonic and 7th.
- **Perc. 1** Footswitch plays a percussion instrument from the 98 DRUM KIT voice (see "Notes").
- **Perc. 2** Footswitch plays a percussion instrument from the 99 POP DRUM KIT voice (see "Notes").

- **Start/Stop** Same as panel [START] and [STOP] buttons.
- **Start/Re-Start** Same as panel [START/RE-START] button.
- **Intro1/Fill** Same as panel [INTRO. 1/FILL IN] button.
- **Intro2/Fill** Same as panel [INTRO. 2/FILL IN] button.
- **Intro3/Ending/rit** .. Same as panel [INTRO. 3/ENDING/rit.] button.
- **V.Regist. +** Recall next (increment) voice registration.
- **P.Regist. +** Recall next (increment) panel registration.
- **Tap Start** Same as PAD Tap Start function.

Notes:

When the "Perc. 1" or "Perc. 2" setting is selected a new parameter appears to the right of the screen. This allows you to select the drum or percussion instrument that will be played when the footswitch is pressed. To select an instrument either use the right [-] and [+] buttons, or press the corresponding key on the keyboard. The preset velocity value will be assigned if the [-] and [+] buttons are used, while the velocity at which the key is played will be assigned if the keyboard is used to select the drum/percussion instrument.

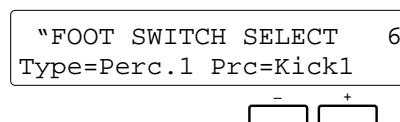

3 EXP. PEDAL SELECT

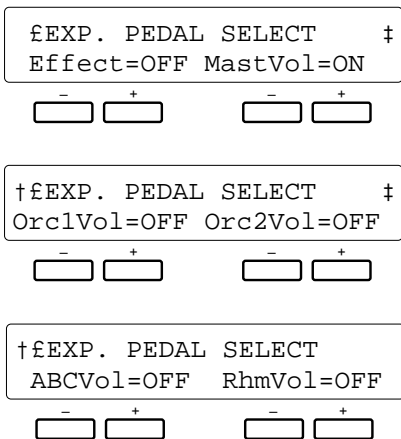

Purpose:

Determines which of the PSR-5700's parts (orchestra, rhythm, etc.) an expression pedal plugged into the rear-panel EXP. PEDAL jack will control.

Procedure:

Use the [`<`] and [`>`] buttons to switch between the three display screens. Use the [`-`] and [`+`] buttons below each parameter to turn expression control on or off:

- **Effect** Effect control (Same as MODULATION/EFFECT wheel. All other parameters automatically OFF).
- **MastVol** Master volume control.
- **Orch1Vol** ... Orchestra 1 volume control.
- **Orch2Vol** ... Orchestra 2 volume control.
- **ABCVol** ABC accompaniment volume control.
- **RhmVol** Rhythm volume control.

Notes:

Normally you'll want to be able to apply expression control to the orchestra voices without affecting the accompaniment and rhythm sound, so "Orch1Vol" should be turned on while the remaining parameters are turned off.



When "MastVol", "Orc1Vol", "Orc2Vol", "ABCVol", or "RhmVol" is turned ON, "Effect" is automatically turned OFF.



When "Orc1Vol", "Orc2Vol", "ABCVol", or "RhmVol" is turned ON, "MastVol" and "Effect" are automatically turned OFF.



The "Effect" setting only applies when the panel [EFFECT] button is turned ON.

4 SUSTAIN PART SELECT

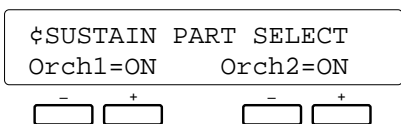

Purpose:

Determines whether the PSR-5700 sustain effect is to be applied to the orchestra 1 voice, the orchestra 2 voice, or both orchestra voices.

Procedure:

Use the left [`-`] and [`+`] buttons to turn sustain on or off for the orchestra 1 voice, and the right [`-`] and [`+`] buttons to turn sustain on or off for the orchestra 2 voice.

Notes:

The sustain effect is applied to the specified orchestra part(s) only when the panel [SUSTAIN] button is turned on or when the sustain pedal is pressed.

5 PITCH BEND SELECT

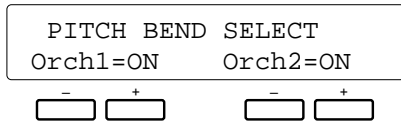

Purpose:

Determines whether the PITCH BEND/GLISSANDO wheel will affect the orchestra 1 voice, the orchestra 2 voice, or both orchestra voices.

Procedure:

Use the left [-] and [+] buttons to turn pitch wheel control on or off for the orchestra 1 voice, and the right [-] and [+] buttons to turn pitch wheel on or off for the orchestra 2 voice.

Notes:

If, for example, you're using the split mode (ORCH. 2√ 1) with a bass voice on the left and a sax voice on the right, you'll want pitch bend to apply only to the right-hand sax voice. In this case simply turn orchestra 1 pitch bend on and orchestra 2 pitch bend off.

If AUTO BASS CHORD is on and the ORCH. 2√ 1 orchestration mode is selected, no pitch bend is applied to the ORCH. 2 voice.

6 WHEEL SELECT

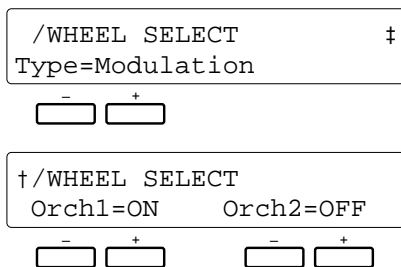

Purpose:

Determines whether the MODULATION/EFFECT wheel will control modulation or the selected effect (page 36), and whether it will affect the orchestra 1 voice, the orchestra 2 voice, or both orchestra voices.

Procedure:

Use the left [-] and [+] buttons to select either “Modulation” or “Effect” operation, then press the [>] button to move to the second display screen and use the left [-] and [+] buttons to turn wheel control on or off for the orchestra 1 voice, and the right [-] and [+] buttons to turn wheel control on or off for the orchestra 2 voice.

Notes:

This function can be used to apply modulation or the selected effect to just one of the voices being played in the split mode (ORCH. 2√ 1) to emphasize that voice and provide greater contrast with the other voice.

When “Effect” operation is selected, the wheel will function only when the panel [EFFECT] button is turned on.

If AUTO BASS CHORD is on and the ORCH. 2√ 1 orchestration mode is selected, no modulation is applied to the ORCH. 2 voice.

[F4] Split Point, Interactive Accompaniment, &

1 SPLIT POINT

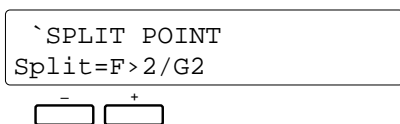

Purpose:

Sets the split point for the ORCH.2 \checkmark 1 and AUTO BASS CHORD accompaniment modes.

Procedure:

Use the left [-] and [+] buttons to set the split point.

Another way to set the split point is to press the key that is to be the highest key in the left-hand range — when this is done the SPLIT POINT function is automatically exited.

Notes:

Press the [-] and [+] buttons simultaneously to recall the default split point setting (F#2/G2).

2 INTERACTIVE ACCOMP.

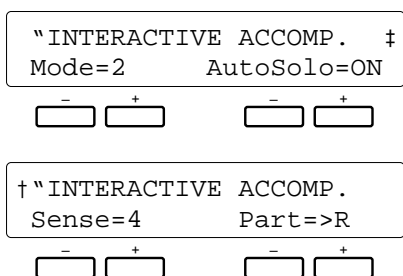

Purpose:

Selects one of two available Interactive Accompaniment modes, turns the AUTO SOLO function on or off, sets the sensitivity of the Interactive Accompaniment function, and determines the keyboard part on which Interactive Accompaniment will be based.

Procedure:

Use the [<] and [>] buttons to switch between the two display screens.

Use the left [-] and [+] buttons in the first screen to select Interactive Accompaniment mode 1 or 2, and use the right [-] and [+] buttons to turn the AUTO SOLO function on or off.

Use the left [-] and [+] buttons in the second screen to set the desired Interactive Accompaniment sensitivity, and use the right [-] and [+] buttons to select the keyboard part on which Interactive Accompaniment is to be based.

Notes:

- **Mode:** When Interactive Accompaniment mode 1 is selected, accompaniment parts that may interfere with what is played on the keyboard are automatically lowered in

volume when the keyboard is being played. When Interactive Accompaniment mode 2 is selected, the above function is combined with automatic muting of interfering parts and automatic switching between VERSE 1 and VERSE 2 or between CHORUS 1 and CHORUS 2 in response to keyboard activity.

The default Mode setting is “2”.

- **AutoSolo:** When the AUTO SOLO function is turned ON, the solo accompaniment variations will automatically be activated if nothing is played on the keyboard for a few measures (the actual number of measures depends on the selected style). Further, the solo variations will automatically be de-activated at the end of the current phrase after keyboard performance is resumed. No automatic solo switching occurs when the AUTO SOLO function is turned off.

The default AutoSolo setting is “on”.

- **Sense:** The sensitivity range is from “1” to “8.” “8” is the highest sensitivity. In this case “sensitivity” refers to how much activity the Interactive Accompaniment system must detect in the specified section(s) of the keyboard before a change in the accompaniment occurs.

The default Sense setting is “4”.

- **Part:** When the “PART” parameter is set to “L+R”, the Interactive Accompaniment system responds to activity (i.e. anything you play) on the entire keyboard. When set the “>R” only activity on the right-hand section of the keyboard is detected, and when set to “L<” only activity on the left-hand section of the keyboard is detected.

The default Part setting is “>R”.

Super Style Play Mode

3 SUPER STYLE PLAY MODE



Purpose:

Determines whether Super Style Play variation switching will occur at the same time as Accompaniment Verse-to-Chorus switching.

Procedure:

Use the left or right [-] and [+] buttons to turn Super Style Play “SectionChanging” on or off.

Notes:

Turning this function on can provide greater contrast between the chorus and verse variations when using the Accompaniment feature.



The default setting is “ON”.

[F5] Disk

Although the [F5] DISK function accesses a range of important disk functions, the most commonly used disk functions — save to disk and load from disk — can also be directly accessed via the [TO DISK] and [FROM DISK] buttons, as described below.

Please note that no other PSR-5700 functions will operate while a disk function is in progress.

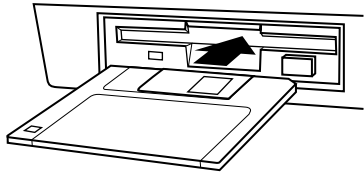

For any disk operation an appropriate floppy disk must first be properly inserted into the PSR-5700 disk drive. The PSR-5700 uses only 3.5" 2DD type floppy disks. Make sure the disk write protect tab is set to the "write enable" position if you intend to save any data to the disk, and insert the disk with the sliding disk cover facing the disk drive and the disk label facing upward. Before a new disk can be used to save data, it must be formatted using the "FORMAT DISK" function described on page 47.

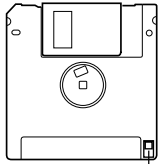

Write Protect tab

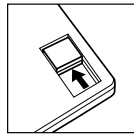

Write Protect OFF

The [TO DISK] Button

Press this button when you want to save the current contents of the PSR-5700 memory (see list below) to floppy disk for later re-loading and use. The display shown to the left will appear:

TO DISK	Size:---k
00:N_FILE00	NO YES

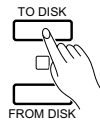

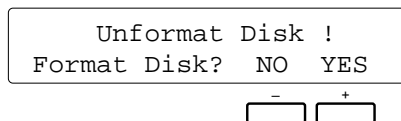
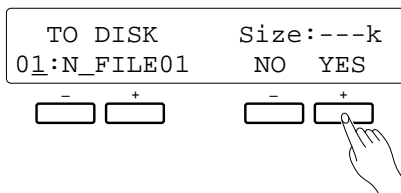
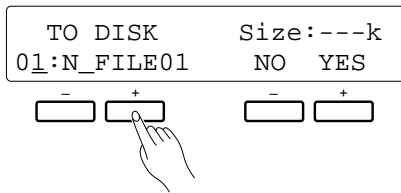

With the cursor located under the file number parameter at the left of the lower display line (use the [>] button to move the cursor if necessary), use the left [-] and [+] buttons to specify a number for the file to be saved (00 — 99). If a file with the selected number already exists on the disk, the name of the selected file will be displayed to the right of the number (if no name has been assigned, “N_FILE” will appear), and the size of the file in kilobytes (approximate) will be shown on the upper display line. New files have a “0” size. The cursor can be moved to the various character positions in the file name (8 characters maximum) and the name edited by selecting the appropriate characters for each position via the left [-] and [+] buttons.

When the file number has been specified, press the right [+] button under “YES” on the display to execute the save operation (or press the [-] button under “NO” on the display to cancel the operation). “Don’t remove disk” will appear while the data is being saved, and the amount of remaining data to be saved will be displayed in arbitrary units on the upper display line. “Completed!” will appear when the data has been successfully saved.

The data saved to disk is as follows:

- Instrument setup (condition) data.
- Disk style data.
- Custom voice data.
- Custom accompaniment data.
- Voice registration data.
- Panel registration data.
- Super style play data.
- Pad assignment data (Multi, Tempo, and Percussion assignments).
- Sequencer song data.

See page 48 for a list of error messages that may appear during disk save.

If you insert a disk that has not been formatted into the drive, the display shown to the left will appear when the [TO DISK] button is pressed:

Press the [+] button under “YES” on the display to format the disk (see “5. FORMAT DISK” on page 47).



The PSR-5700 identifies and handles disk files by number rather than the file name. If you save to a file number that already contains data, the original data will be erased and replaced by the new data.

The [FROM DISK] Button

Press this button when you want to re-load a previously saved file from floppy disk. The data loaded is the same as that saved by the TO DISK operation described above. When the [FROM DISK] button is pressed the display shown to the left will appear:

```
FROM DISK      Size: 35k
00:N_FILE00    NO  YES
```

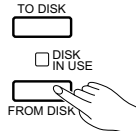

```
FROM DISK      Size: 35k
01:N_FILE01    NO  YES
```

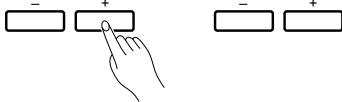

```
FROM DISK      Size: 35k
01:N_FILE01    NO  YES
```

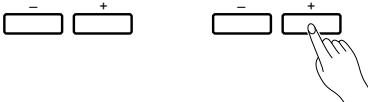

Use the left [-] and [+] buttons to select the number of the file to load (00 — 99, file numbers that contain no data will not be displayed). The name of the selected file will be displayed to the right of the number, and the size of the file in kilobytes (approximate) will be shown on the upper display line.

When the file number has been specified, press the right [+] button under “YES” on the display to execute the load operation (or press the [-] button under “NO” on the display to cancel the operation). “Don’t remove disk” will appear while the data is being loaded, and the amount of remaining data to be loaded will be displayed in arbitrary units on the upper display line. “Completed!” will appear when the data has been successfully loaded.

The [FROM DISK] button allows all data in a file to be loaded at once. To load individual data groups use the FROM DISK function described on page 45.

See page 48 for a list of error messages that may appear during a disk load operation.

The [F5] DISK Functions

The [F5] DISK function accesses a range of functions that are used for storage and retrieval of floppy disk data.

Not Found Disk !

If you select the [F5] when no disk is present in the drive, the “Not Found Disk!” error message will appear on the display.

1 FROM DISK

• First Screen

```

`FROM DISK   Size: 35k†
00:N_FILE00 : AllData
  -   +       -   +
  [ ] [ ]     [ ] [ ]
    
```

• Second Screen
(When SEQUENCER selected)

```

†`FROM DISK   Size: 2k†
  Song=1     -> Song=1
  -   +       -   +
  [ ] [ ]     [ ] [ ]
    
```

(When optional disk “AllData” or “Disk Style” selected)

```

†`FROM DISK   Size: 29k†
  1-16Slow
  -   +
  [ ] [ ]
    
```

• Second/Third Screen
(When optional disk “AllData”, “Disk Style”, or “Sequencer” selected)

```

†`FROM DISK
Are you sure? - YES -
  -   +
  [ ] [ ]
    
```

Purpose:

Loads the specified file from a floppy disk inserted into the PSR-5700 disk drive.

Procedure:

Use the left [-] and [+] buttons to select the number of the file to load (00 — 99). The name of the selected file will be displayed to the right of the number, and the size of the file in kilobytes (approximate) will be shown on the upper display line. The right [-] and [+] buttons can be used to select the type of data to be loaded, as shown in “Notes:” below.

When the file and data type have been specified, press the [>] button to select the next display screen, and press the right [-] and [+] buttons under “-YES-” on the display simultaneously to execute the load operation. “Don’t remove disk” will appear while the data is being loaded. “Completed!” will appear when the data has been successfully loaded.

Notes:

The following data types can be selected for loading:

- **AllData** All of the below.
- **SetUp** Instrument setup (condition) data.
- **DiskStyle** Disk style data.
- **Cus.Voice** ... Custom voice data.
- **Cus.Style** Custom accompaniment data.
- **V.Regist** Voice registration data.
- **P.Regist** Panel registration data.
- **SSP** Super style play data.
- **PadAssign** .. Multi, Tempo, and Percussion pad assignment data.
- **Sequencer** .. Sequencer song data.

2 TO DISK

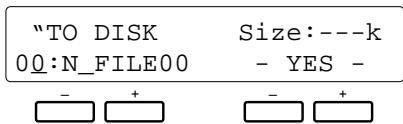

Purpose:

Saves the data listed in “Notes;” below, to a floppy disk inserted into the PSR-5700 disk drive.

Procedure:

With the underline cursor located under the file number parameter at the left of the lower display line (use the [$>$] button to move the cursor if necessary), use the left [$-$] and [$+$] buttons to select the number of the file to save (00 — 99). If a file with the selected number already exists on the disk, the name of the selected file will be displayed to the right of the number (if no name has been assigned, “N_FILE” will appear), and the size of the file in kilobytes (approximate) will be shown on the upper display line. New files have a “0” size. The cursor can be moved to the various character positions (8 characters maximum) in the file name by using the [$<$] and [$>$] buttons, and the name can be edited by selecting the appropriate characters for each position via the left [$-$] and [$+$] buttons.

When the file number has been specified, press the right [$-$] and [$+$] buttons under “-YES-” on the display simultaneously to execute the save operation. “Don’t remove disk” will appear while the data is being saved. “Completed!” will appear when the data has been successfully saved.

Notes:

The following data are saved to disk when the save operation is executed:

- Instrument setup (condition) data.
- Disk style data.
- Custom voice data.
- Custom accompaniment data.
- Voice registration data.
- Panel registration data.
- Super style play data.
- Pad data.
- Sequencer song data.

All data is saved in one operation. Specific data types can not be saved individually.

See page 48 for a list of error messages that may appear during disk save.



The PSR-5700 identifies and handles disk files by number rather than the file name. If you save to a file number that already contains data, the original data will be erased and replaced by the new data.

3 RENAME FILE

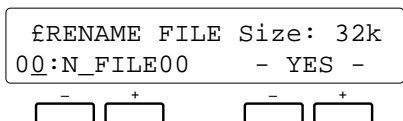

Purpose:

Allows the name of the file having the specified file number to be changed as required.

Procedure:

With the underline cursor located under the file number parameter at the left of the lower display line (use the [$>$] button to move the cursor if necessary), use the left [$-$] and [$+$] buttons to select the number of the file (00 — 99). The current name of the selected file will be displayed to the right of the number, and the size of the file in kilobytes (approximate) will be shown on the upper display line. The cursor can be moved to the various character positions in the

file name and the name edited by selecting the appropriate characters for each position via the left [$-$] and [$+$] buttons.

When the new file name has been entered, press the right [$-$] and [$+$] buttons under “-YES-” on the display simultaneously to register the new name. “Completed!” will appear when the new name has been successfully registered.

Character List

[Space]! # \$ % & ' () 0 1 2 3 4 5 6 7 8 9 @

ABCDEFGHIJKLMNOPQRSTUVWXYZ ^ _ { }

Notes:

This function lets you change the name of a file without having to re-load and then re-save the entire file with a new name.

Since the PSR-5700 uses the file number rather than the file name to recognize and manage data files, a file saved with the same number as another file will overwrite that file even if it has a different name.

4 DELETE FILE

```

çDELETE FILE Size: 32k
00:N_FILE00 - YES -
- + - +

```

Purpose:

Deletes the specified file from the disk.

Procedure:

Use the left [-] and [+] buttons to select the number of the file to be deleted (00 — 99). The name of the selected file will be displayed to the right of the number, and the size of the file in kilobytes (approximate) will be shown on the upper display line.

When the file number has been specified, press the right [-] and [+] buttons under “-YES-” on the display simultaneously to delete the file. “Don’t remove disk” will appear on the display while the delete operation is in progress, the “Completed!” will appear when the file has been deleted.

Notes:

Files deleted from disk can not be restored (there is no “Undo” function), so be sure you’ve selected the right file number before actually executing the delete operation.

5 FORMAT DISK

```

FORMAT DISK
Are you sure? - YES -
- +

```

Purpose:

Formats a floppy disk for use with the PSR-5700.

Procedure:

After inserting a new floppy disk into the disk drive, press the right [-] and [+] buttons under “-YES-” on the display simultaneously to begin formatting. “Don’t remove disk”

will appear while the disk is being formatted, and the number of remaining tracks to be formatted will be shown on the upper display line. “Completed!” will appear when the disk has been successfully formatted.

Notes:

The PSR-5700 uses only 3.5" 2DD type floppy disks. Formatting a disk completely erases all data on the disk, so be sure that the disk you’re formatting does not contain important data!

6 DISK FREE AREA

```

/DISK FREE AREA
90% (640k)

```

Purpose:

Displays the remaining data capacity of the loaded disk in percent and kilobytes.

Notes:

This is a display-only function with no editable parameters.

● Disk Error Messages

If an error is encountered when a disk operation is executed, one of the following error messages may appear:

“ Type Error or Unformat! ”

The disk in the drive has not been formatted or the disk is the wrong type or has the wrong format.

“ Not Found File! ”

The disk does not contain any files saved by the user.

“ Write Protect on ! ”

The disk write protect tab is in the write disable position.

“ Disk Error! ”

A data error has occurred during a save, delete, or format operation.

“ Disk Full! ”

The floppy disk does not have enough remaining capacity to carry out the specified operation.

“ Sample Data Disk! ”

You have attempted to perform a save, rename, delete, format, or disk free area operation while the supplied data disk is in the drive.

“ Style Disk! ”

You have attempted to perform a save, rename, delete, format, or disk free area operation while a style disk or other optional pre-recorded disk is in the drive.

“ Not Found Disk! ”

No disk in drive.

“ Bad File Name! ”

The file name is all spaces and cannot be recognized by the PSR-5700.

“ Not Enough Memory! ”

Not enough memory to load the specified sequencer file from disk.

Some of the error displays automatically revert to the previous display after a few seconds, while others require that the [EXIT] button be pressed to exit from the error display.

If a damaged disk is used the data countdown during FROM DISK or TO DISK operations may stop and the load or save operation may get “hung up.” In this case, eject the disk from the drive even though the DISK IN USE lamp may be on. Discard the damaged disk.

[F6] Utility & MIDI

The [F6] function accesses to utility functions and a versatile range of MIDI functions.

MIDI, the Musical Instrument Digital Interface, is a world-standard communication interface that allows MIDI-compatible musical instruments and equipment to share musical information and control one another. This makes it possible to create “systems” of MIDI instruments and equipment that offer far greater versatility and control than is available with isolated instruments. The PSR-5700 offers a range of MIDI functions that allow it to be used in even sophisticated MIDI systems.

- Always use a high-quality MIDI cable to connect MIDI OUT to MIDI IN terminals. Never use MIDI cables longer than about 15 meters, since cables longer than this can pick up noise which can cause data errors.

1 MEMORY BACKUP

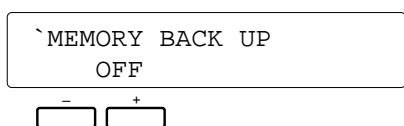

Purpose:

Turns memory backup on or off.

Procedure:

Use the left [-] and [+] buttons to turn memory backup on or off.

Notes:

The data backed up (retained in memory even when the power is turned off) by the PSR-5700 are listed below. When memory backup is turned OFF, the initial factory settings are automatically recalled whenever the power is turned on.

Data Backed Up When MEMORY BACKUP is ON

- Sequencer Song Data
- Custom Accompaniment Data
- Custom Voice Data
- Disk Style Data
- Panel Registration Memory Data
- Voice Registration Memory Data
- Multi Pad Data
- Tempo Change Data
- Percussion Pad Data
- Super Style Play Data
- Voice Part Select
- Orchestration
- Orchestra 1 Voice
- Orchestra 2 Voice
- Orchestra 1 Octave
- Orchestra 2 Octave
- Harmony On/Off
- Harmony Type
- Style
- ABC On/Off
- ABC Mode
- Manual Bass Voice
- Transpose Data
- Tune
- IA On/Off
- Accompaniment Variation
- Multi Pad Select
- Pad Synchro, Break, Repeat, On/Off
- Left Hold On/Off
- Key Velocity On/Off
- Foot Switch Assign Data
- Foot Switch Percussion
- Expression Pedal Assign Data
- Sustain On/Off
- Sustain Part Select
- Pitch Bend Select
- Wheel On/Off
- Wheel Type
- Split Point
- IA Mode
- Auto Solo On/Off
- IA Sensitivity
- IA Part
- Super Style Play Mode
- Reverb On/Off
- Reverb Type & Depth
- Effect On/Off
- Effect Type & Depth
- Memory Backup On/Off
- MIDI Transmit Ch
- MIDI Receive Ch
- MIDI Split Send Ch
- MIDI Rhythm Receive Ch
- MIDI Sequencer Ch
- MIDI Multi Part Ch
- MIDI Multi Part Volume
- MIDI Multi Part Voice
- MIDI Switch (Control Change, Pitch Bend, Program Change, System Exclusive)
- MIDI Clock
- MIDI Local On/Off
- MIDI Transpose Add Note
- MIDI Split Send On/Off, Enable

* The above data will be retained in memory for about one week even if the power is not turned on. To retain the backed up data for longer periods, turn the power switch ON for a few minutes at least once a week.

* The default setting for this parameter is “OFF”.

Data Backed Up When MEMORY BACKUP is OFF

- Sequencer Song Data
- Custom Accompaniment Data
- Custom Voice Data
- Disk Style Data
- Panel Registration Memory Data
- Voice Registration Memory Data
- Multi Pad Data
- Tempo Change Data
- Percussion Pad Data
- Super Style Play Data

2 RECALL INITIAL DATA

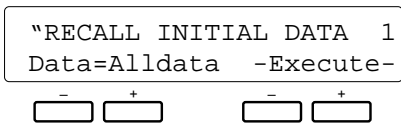

Purpose:

Recalls the specified initial factory settings.

Procedure:

Use the left [-] and [+] buttons to select the type of factory preset data you want to recall (see “Notes” below), then press both the right [-] and [+] buttons simultaneously. “Busy!” will appear while the initialization is taking place, and “Completed” will appear when the initialization is complete.

Notes:

Here’s a list of the data types that can be initialized by this function:

LCD	Data Type
AllData	All data.
Pad	Pad data.
V.Regist	Voice registration data.
P.Regist	Panel registration data.
SSP	Super style play data.
ABC&IA	Auto Bass Chord & Interactive Accompaniment data.
HarmoType .	Harmony type data.
CusVoice	Custom voice data.
Effect	Effect type, depth.
Reverb	Reverb type, depth.
Control	All controller settings (F3 function group).
Split	Split point.
Midi	All MIDI data.

The [DISK ORCHESTRA/GENERAL MIDI] Button

The PSR-5700 is compatible with both Yamaha Disk Orchestra Collection and General MIDI (GM) software. To use such software, press the [DISK ORCHESTRA/GENERAL MIDI] button in order to switch the PSR-5700 tone generator system to the DOC/GM mode. When the DOC/GM mode is selected you can select and play the voices via the PSR-5700 itself, or control the voices from an external MIDI sequencer or music computer. Data transmitted from the PSR-5700 can also be used to control an external GM-mode tone generator.

The PSR-5700 normal play mode is known as the REMOTE CONTROL mode.

● PLAYING DOC OR GENERAL MIDI SOFTWARE ON THE PSR-5700

The PSR-5700 can play optional Yamaha Disc Orchestra Collection software, and General MIDI mode software recorded by other equipment. When a disk of either type (3.5" 2DD disks only) is inserted into the PSR-5700 disk drive, the PSR-5700 automatically switches the internal tone generator system to allow playback of the software and performance on the keyboard (Getting Started, page 40).

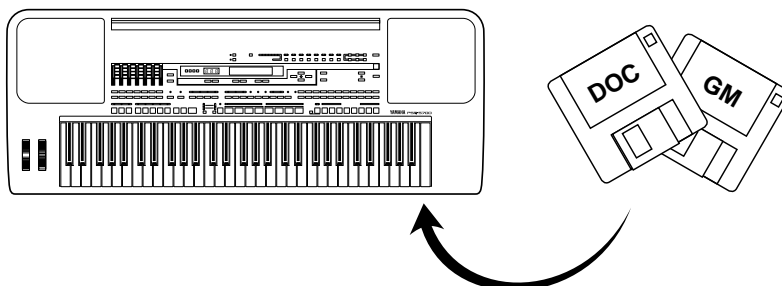

● GENERAL MIDI DATA RECEPTION/TRANSMISSION

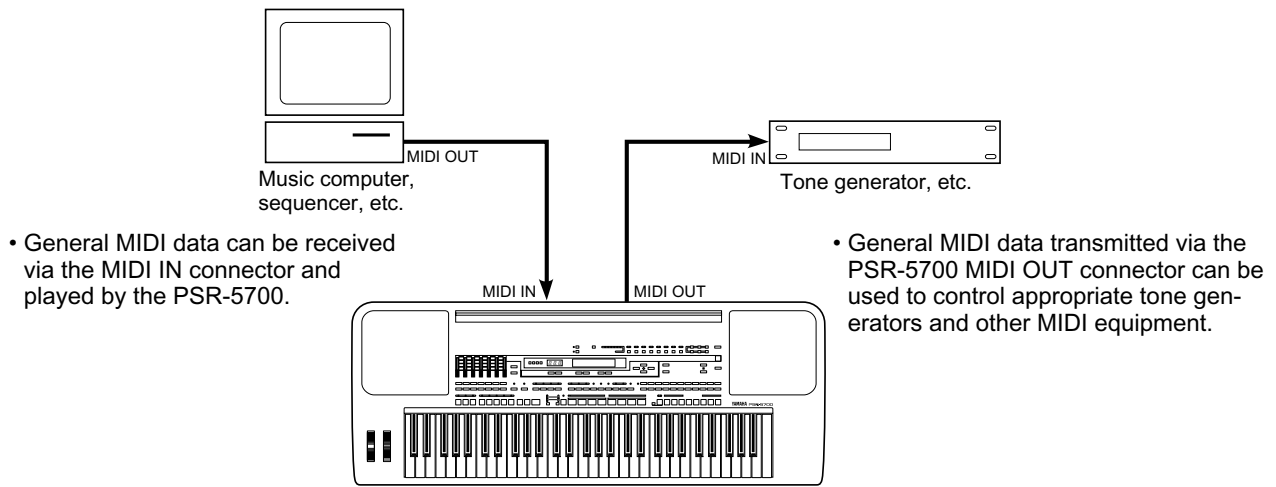

○ ABOUT GENERAL MIDI

The existing MIDI protocol allows performance and other data to be transferred between different instruments, even if they are from different manufacturers. This means, for example, that sequence data that was originally created to control a tone generator from manufacturer A can also be used to control a different tone generator from manufacturer B. Since the voice allocation in different devices from different manufacturers is usually different, however, appropriate program change data must be transmitted to select the right voices.

The General MIDI protocol was developed to minimize confusion and the need for re-programming when playing software created by one MIDI device on another. This has been achieved by defining a standard voice allocation in which the same or similar voices are accessed by the same program change numbers or MIDI channels. The current standard recognized by the International MIDI Association is known as “GM System Level 1.” The PSR-5700 voice allocation complies with the GM System Level 1 standard when it is switched to the DOC/GM mode. See the “GENERAL MIDI (GM) Voice List” on page 254 for details.

■ THE REMOTE CONTROL MODE

The PSR-5700's normal mode of operation (i.e. when the DOC/GM mode is not selected) is known as the REMOTE CONTROL mode. In this mode key on/off, voice, sustain, volume, pitch bend, and other performance data is transmitted and received without modification directly via the MIDI OUT and MIDI IN connectors. The receive channel is determined by the MIDI channel setting parameter described on page 54. It is also possible to play the rhythm instrument voices via the rhythm channel (page 54). More complex control is available through the Multi Part Setting parameters (page 56), allowing up to 8 different voices to be controlled via different MIDI channels. It is possible, for example, to play a number of melody parts from an external MIDI control device to the accompaniment of the PSR-5700 ABC system.

■ THE DOC MODE

In this mode the PSR-5700 can play Yamaha Disk Orchestra (DOC) software. MIDI data is also transmitted and received in accordance with Yamaha DOC specifications.

For details refer to the "MIDI Function Tree" on page 242, the "DISK ORCHESTRA (DOC) Mode Voice List" on page 253, and the "GM/DOC Mode Percussion Map" on page 256.

● 3 Ways To Select the DOC Mode

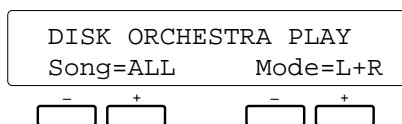

- Insert a DOC disk (the DOC mode is automatically selected).
- Press the [DISK ORCHESTRA/GENERAL MIDI] button.
- Receive a MIDI exclusive "Switch To DOC Mode" message from an external MIDI device.

● Controls That Function In the DOC Mode

- Keyboard.
- Volume controls (Getting Started, page 41).
- VOICE SELECT button.*
- [+] and [-] buttons.
- [S] and [t] page buttons (Move to the voice select screen).
- [<] and [>] shift buttons (Move to the transpose, tune, and octave change screens. Octave change only applies to Orchestra 1).
- START and STOP buttons (ABC does not function).
- REVERB and EFFECT buttons.
- TEMPO button (The recommended tempo can be selected by pressing both the [+] and [-] buttons simultaneously).
- SUSTAIN button and pedal (Affects notes played on the keyboard. Sustain Part Select fixed at Orchestra 1).
- PITCH BEND (Affects notes played on the keyboard. Pitch Bend Select fixed at Orchestra 1. Range fixed at ± 300 cents).
- WHEEL (Modulation applies to Orchestra 1).
- KEY VELOCITY (Applies to notes played on the keyboard. Fixed at KEY VELOCITY = ON).

- PAD (Fixed at PERCUSSION. Voices fixed as per REMOTE CONTROL mode, and cannot be changed in the DOC mode).
- FOOT SW (Applies to notes played on the keyboard. Footswitch Select fixed at GLIDE).
- EXP. PEDAL (Applies to notes played on the keyboard. Exp. Pedal Select fixed at Orc1Vol).
- FUNCTION buttons (Only MIDI settings — F2 and F6 — can be changed).
- MIDI transmission/reception.

* Both the BANK and NUMBER VOICE SELECT buttons can be used, but some numbers do not have assigned voices and cannot be selected (refer to the "DISK ORCHESTRA (DOC) Mode Voice List" on page 253). These voice numbers are skipped when the [-] and [+] buttons are used.



Since octave offset is applied to some voices played via the keyboard in the DOC mode, the pitch of notes played via the keyboard may not match that of those played by the corresponding MIDI note numbers.



If you select a function that is not available in the DOC mode, "Not Available in DOC!" will appear on the display.

● 3 Ways to Exit From the DOC Mode

- Remove the DOC disk.
- Press the [DISK ORCHESTRA/GENERAL MIDI] or [EXIT] button.
- Receive any MIDI exclusive message that selects a different mode from an external MIDI device.

THE GENERAL MIDI (GM) MODE

In this mode MIDI data is received and transmitted in accordance with the General MIDI Level 1 standard.

For details refer to the “MIDI Function Tree” on page 242, the “GENERAL MIDI (GM) Mode Voice List” on page 254, and the “GM/DOC Mode Percussion Map” on page 256.

3 Ways To Select the GENERAL MIDI Mode

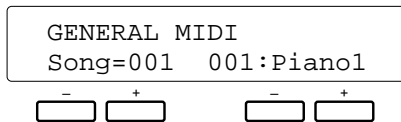

- Insert a General MIDI disk (the GM mode is automatically selected).
- Press the [DISK ORCHESTRA/GENERAL MIDI] button.
- Receive a MIDI exclusive “Switch To GM Mode” message from an external MIDI device.

When the General MIDI mode is selected, the parameters listed below are initialized as shown. As for the panel setup data, only the MIDI channel and the volume and expression settings for the rhythm channel are initialized.

General MIDI Level 1 Mode Initial Settings

Program Change# 1 (Piano 1)
 Pitch Bend ±0 (Center)
 Volume 100
 Pan Voice Preset
 Modulation 0 (Off)
 Expression 127 (Max.)
 Hold (Sustain) 0 (Off)
 Pitch Bend Sense 02H/00H (2 semitones)
 Fine Tune 40H/00H ±0
 Coarse Tune 40H/00H ±0
 RPN NULL



Only GM data recorded on 3.5" 2DD IBM-format disks in standard MIDI file format 0 or 1 can be played on the PSR-5700 (up to track 17 with format 1). Also note that data that does not comply with GM Level 1 specifications may not be reproduced.

* “IBM” is a registered trademark of International Business Machines.

Controls That Function In the GENERAL MIDI Mode

- Keyboard.
- ORCH1 volume control (controls the volume of the notes played on the keyboard).
- VOICE SELECT button (01 through 99 only. Use the [-] and [+] buttons for other voice numbers. Refer to the “GENERAL MIDI (GM) Mode Voice List” on page 254).
- [+] and [-] buttons.
- [S] and [T] page buttons (Move to the volume control screen for all channels*).
- [<] and [>] shift buttons (Move to the transpose, tune, and octave change screens. Octave change only applies to Orchestra 1. Tune not available).
- START and STOP buttons (ABC does not function).
- REVERB and EFFECT buttons (REVERB is automatically turned on when the GM mode is selected).
- TEMPO button (The recommended tempo can be selected by pressing both the [+] and [-] buttons simultaneously).
- SUSTAIN button and pedal (Affects notes played on the keyboard. Sustain Part Select fixed at Orchestra 1).
- PITCH BEND (Affects notes played on the keyboard. Pitch Bend Select fixed at Orchestra 1. Range fixed at ±200 cents).
- WHEEL (Modulation applies to notes played on the keyboard).
- KEY VELOCITY (Applies to notes played on the keyboard. Fixed at KEY VELOCITY = ON).
- PAD (Fixed at PERCUSSION. Voices fixed as per REMOTE CONTROL mode, and cannot be changed in the GM mode).
- FOOT SW (Applies to notes played on the keyboard. Footswitch Select fixed at GLIDE).
- EXP. PEDAL (Applies to notes played on the keyboard. Exp. Pedal Select fixed at Orc1Vol).
- FUNCTION buttons (Only MIDI settings — F2 and F6 — can be changed).
- MIDI transmission/reception.



Coarse tuning and fine tuning can be controlled by MIDI data reception only.



Rhythm data can be received on channel 10 only.



See the “GM/DOC Mode Percussion Map” on page 256 for details on which rhythm voices are played by which note numbers.



If you select a function that is not available in the GM mode, “Not Available in GM!” will appear on the display.

[F6] Utility & MIDI

* The [S] and [T] page buttons can be used to access the volume control screen for all channels.



Use the left [-] and [+] buttons to move the cursor to the channel for which the volume is to be adjusted, then use the right [-] and [+] buttons to adjust the volume. The longer the graphic bar on the display, the higher the volume.

The numbers across the top of the display above the bar graphs correspond to the MIDI channels. From left to right the channels are 1 through 9, “R” is channel 10 (the rhythm channel), and numbers 1 through 6 to the right of “R” correspond to channels 11 through 16.

● 3 Ways to Exit From the GENERAL MIDI Mode

- Remove the General MIDI disk.
- Press the [DISK ORCHESTRA/GENERAL MIDI] or [EXIT] button.
- Receive any MIDI exclusive message that selects a different mode from an external MIDI device.

3 MIDI CHANNEL SETTING

The contents of this page are different depending on whether the Remote Control mode or the DOC/GM mode is selected.

● Remote Control Mode

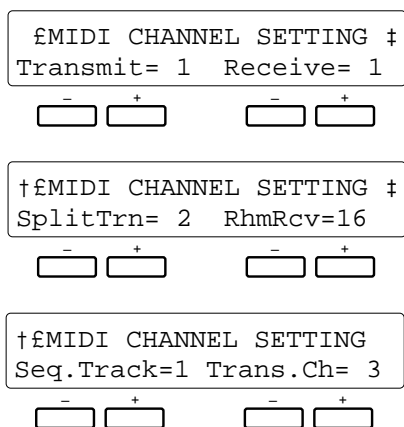

Purpose:

Sets the basic transmit, basic receive, split transmit, rhythm receive, and individual sequencer track transmit channels.

Procedure:

In the first display screen the left [-] and [+] buttons select the basic transmit channel (1 ... 16) and the right [-] and [+] buttons select the basic receive channel (1 ... 16, All).

In the second display screen the left [-] and [+] buttons select the split (left-hand) transmit channel (1 ... 16) and the right [-] and [+] buttons select the rhythm receive channel (1 ... 16).

In the third display screen the left [-] and [+] buttons select a sequencer track number (1 ... 7) and the right [-] and [+] buttons select the transmit channel (1 ... 16) for that track.

Notes:

The various channel settings are as follows:

- **Transmit**
This setting is the same in the Remote Control and DOC/GM modes. It determines the basic channel on which all PSR-5700 data will be transmitted.
- **Receive**
The receive channel setting is the same in the Remote Control and DOC/GM modes, except that in the DOC/GM mode only MIDI system exclusive messages will be received. The receive channel is the basic channel on which the PSR-5700 will receive all MIDI data. If set to “All,” data can be received via all 16 MIDI channels.
- **SplitTrn**
The split transmit channel functions only in the Remote Control mode. This is the channel on which left-hand performance data (i.e. data produced by playing keys to the left of the split point) will be transmitted. Right-hand performance data is transmitted on the basic transmit channel specified in the first display screen.
- **RhmRcv**
This setting is the same in the Remote Control and DOC/GM modes. It specifies an independent MIDI channel via which the PSR-5700’s rhythm (drums and percussion) can be controlled. This means you can, for example, play the selected voice via the basic receive channel while simultaneously playing the rhythm instruments via a different channel (i.e. the RhmRcv channel).

• Seq.Track/Trans.Ch

This setting only applies when the Remote Control Mode is selected. Separate transmit channels can be set for sequencer tracks 1 through 7 (the ACCOMP. track does not transmit) so the PSR-5700 sequencer can be used to drive an external multi-timbre tone generator or multiple tone generators via the specified channels.



If basic, split, and or sequencer track transmit channels are set to the same MIDI channel number, an exclamation mark (!) will appear next to the channel number. If the basic and split transmit channels are set to the same number, the data from both the left- and right-hand sections of the keyboard will be transmitted on the basic transmit channel (the content of the data to be transmitted can be set via the "SPLIT SEND PART" function described on page 57). Further, if several sequencer tracks are set to transmit on the same channel, the data from all those tracks will be transmitted on the same channel.



As with the transmit channels described above, if the basic, rhythm, and or multi part (page 56) transmit channels are set to the same MIDI channel number, an exclamation mark (!) will appear next to the channel number. In this case the received data will apply to all voices accessed by that channel number. If, for example, the basic, rhythm, and multi part receive channels are all set to the same number, any note data received on that channel will play the orchestra 1, rhythm, and multi part voices simultaneously.



If the basic receive channel is set to "All," a multi part receive channel cannot be assigned.

● DOC/GM Mode

£DOC/GM SETTING † KeyboardCh= 1 Local=ON - + - +
†£DOC/GM SETTING TransposeAddNote=ON - +

Purpose:

Sets the transmit channel and turns local control on or off for the DOC/GM mode.

Procedure:

Use the left [-] and [+] buttons set the transmit channel (1 ... 16) and the right [-] and [+] buttons to turn local control on or off. The "TransposeAddNote" parameter is available in the second screen.

Notes:

The "Local" parameter determines whether the PSR-5700 is controlled by its own keyboard or MIDI data received from an external MIDI device. When local control is on, the PSR-5700 keyboard controls its internal tone generator, allowing the internal voices to be played directly from the keyboard. Local control can be turned off, however, so that the PSR-5700 keyboard does not play the internal voices, but the appropriate MIDI information is still transmitted via the MIDI OUT connector when notes are played on the keyboard. At the same time, the internal tone generator responds to MIDI information received via the MIDI IN connector. This means that while an external sequencer or MIDI computer, for example, plays the PSR-5700's internal voices, an external tone generator can be played from the PSR-5700 keyboard.

When Local is "ON" voice and controller parameters that can be played via the keyboard are set to the same channel as the transmit channel.

• TransposeAddNote

When this parameter is turned "OFF," the PSR-5700 transpose settings are not applied to transmitted MIDI data. When turned "ON," the PSR-5700 transpose settings apply to transmitted MIDI data in the same they do to notes played on the PSR-5700 itself. As for received MIDI data, when this parameter is "ON" the note data is not transposed, and when set to "OFF" the note data is transposed.

Use the right [-] and [+] buttons to turn this parameter ON or OFF.



In addition to accepting MIDI note data on 16 channels (also during disk playback), the PSR-5700 has a separate keyboard note channel. Data on this channel can only be controlled via the PSR-5700 panel controls (when "Local" is "ON"), and is not affected by MIDI data. This data is transmitted via MIDI OUT, on the "KeyboardCh".

4 MULTI PART SETTING (Remote Control Mode Only)

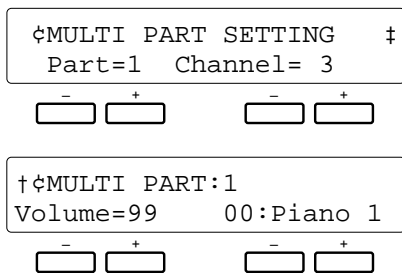

Purpose:

Allows the receive channel, volume, and voice to be independently specified for 8 separate “parts” to be controlled from an external MIDI device.



In the DOC mode MIDI reception occurs via channels 1 through 10, and channel 15 (rhythm part). In the GM mode, reception occurs on all channels regardless of these settings.

Procedure:

In the first display screen use the left [-] and [+] buttons to select a part number (1 ... 8) and the right [-] and [+] buttons select the receive channel (1 ... 16, Off) for that part.

In the second display screen the right [-] and [+] buttons select the voice for the currently selected part number in the second display screen, while the left [-] and [+] buttons set the volume of the voice.

Notes:

Note that parts that are not required can be turned “OFF” via the “Channel” parameter in the first display screen.

If the channel number of any part is set to the same channel number as a lower-numbered part, the “!OFF” display will appear and that part will be turned off.

Any of the preset or custom voices can be specified via the voice parameter in the second display screen.



If the basic receive channel is set to “All,” reception is disabled on all multi part channels, and “!OFF” appears in place of the multi part channel numbers.

5 MIDI SWITCH (Remote Control Mode Only)

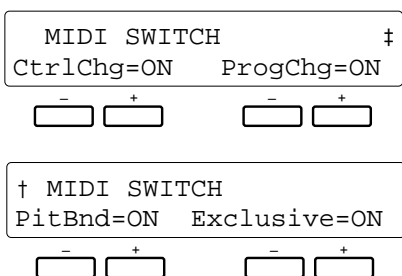

Purpose:

Allows reception and transmission of control change, program change, pitch bend, and system exclusive data to be independently turned on or off.

Procedure:

Use the [<] and [>] buttons to switch between display screens, and the [-] and [+] buttons below each parameter to turn reception/transmission of the corresponding MIDI data on or off.

Notes:

These “switches” can be used to determine how the PSR-5700 responds to MIDI data received from external equipment. If, for example, you don’t want the PSR-5700 voices to be changed by program change messages received from an external device, turn the program change switch “OFF.”

The same applies to transmission from the PSR-5700 — turn off data that you don’t want to be transmitted to external equipment.

In the DOC/GM mode, all control change data are transmitted and received regardless of the settings on this page.

6 MIDI SYSTEM (Remote Control Mode Only)

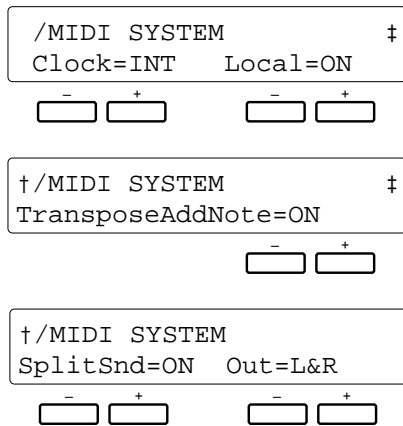

Purpose:

These three display screens provide access to a number of important MIDI system “switches” — internal or external clock synchronization, local control on/off, transpose data transmission on/off, and split mode data transmission on/off.

Procedure:

Use the [`<`] and [`>`] buttons to switch between display screens, and the [`-`] and [`+`] buttons below each parameter to select the desired state for each parameter.

Notes:

The various system parameters operate as follows:

- **Clock**

The “INT” (internal) clock setting is the normal setting when the PSR-5700 is being used alone. If you are using the PSR-5700 with an external sequencer, MIDI computer, or other MIDI device, and you want the PSR-5700 to be synchronized to the external device, set this function to “EXT” (external). In the latter case, the external device must be connected to the PSR-5700 MIDI IN connector, and must be transmitting an appropriate MIDI clock signal.

- **Local**

“Local Control” refers to the fact that, normally, the PSR-5700 keyboard controls its internal tone generator, allowing the internal voices to be played directly from the keyboard. This situation is “Local Control ON” since the internal tone generator is controlled locally by its own keyboard. Local control can be turned off, however, so that the PSR-5700 keyboard does not play the internal voices, but the appropriate MIDI information is still transmitted via the MIDI OUT connector when notes are played on the keyboard. At the same time, the internal tone generator responds to MIDI information received via the MIDI IN connector. This means that while an external sequencer or MIDI computer, for example, plays the PSR-5700’s internal voices, an external tone generator can be played from the PSR-5700 keyboard.



Local control cannot be turned ON or OFF during sequencer recording.

- **TransposeAddNote**

When this parameter is turned “OFF”, the transmitted MIDI note data will not be affected by the PSR-5700 transpose setting. When “ON,” the transmitted notes will be transposed in accordance with the PSR-5700 transpose setting. The reverse is true for reception: when “ON” received note data is not transposed; when “OFF” received note data is transposed.

- **SplitSnd/Out**

When the SplitSnd (split send) parameter is turned “ON,” the setting of the “Out” parameter determines whether MIDI note data from the left-hand (“Left”), right-hand (“Right”), or both sections of the keyboard (“L&R”) are transmitted via the MIDI OUT connector. You could choose to transmit only the right-hand data so that only notes played on the right-hand section of the keyboard are reproduced via an external tone generator, for example. When turned “OFF” data from the entire keyboard is transmitted on the basic transmit channel.

7 DATA TRANSMIT (Remote Control Mode Only)

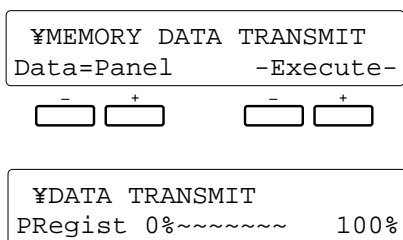

Purpose:

Transmits the specified PSR-5700 panel or memory data via the MIDI OUT connector.

Procedure:

Use the left [-] and [+] buttons to select “Panel” or “Memory” data (see “Notes” below), then press both the right [-] and [+] buttons under “-Execute-” on the display simultaneously to begin data transmission. A bar graph shows the progress of the transmit operation, and “Completed!” will appear on the screen when the transmission is finished.

Notes:

When “Panel” is selected all PSR-5700 panel settings are transmitted.

When “Memory” is selected the following data types are transmitted:

LCD	Data Type
SetUp	Panel data.
VRegist	Voice registration data.
PRegist	Panel registration data.
SSP	Super style play data.
PadData	Multi, tempo, and percussion pad data.
CusVoic	Custom voice data.
CusStyl	Custom style data.
Sequenc	Sequencer data.

The selected data is transmitted as a MIDI bulk dump that can be automatically received by a second PSR-5700 or other compatible MIDI device.

● MIDI Bulk Dump Reception (Memory Data Receive)

The PSR-5700 can receive bulk data transmitted by a second PSR-5700 as long as it is not accessing disk data, the Custom Accompaniment Programmer is not engaged, and the DOC/General MIDI Level 1 mode is not selected. When a bulk dump is received the following display will appear:



The bar graph roughly indicates the progress of the bulk dump receive operation. “Completed!” will appear on the display when the data has been successfully received.

● Receiving MIDI Bulk Dump Request Messages

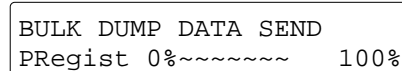

When the REMOTE CONTROL mode is selected and the PSR-5700 receives a MIDI bulk dump request message from an external device, The display shown above appears and a bulk data transmission is performed. Progress of the transmission is shown in bar-graph form on the display.

● Bulk Dump Error Messages

If an error is encountered during bulk reception, a “CHECK SUM DATA ERROR !”, “END OF EXCLUS ERROR !”, or “HEADER DATA ERROR!” error message will appear for a few seconds and the receive operation will be terminated. In the case of a “CHECK SUM DATA ERROR !” or “END OF EXCLUS ERROR !”, the data will be replaced up until the point at which the error occurred. Data being received at the time the error occurred will be initialized. All other data is not affected. In the case of a “HEADER DATA ERROR!”, all data will be left unaltered.



Broken cables and other causes of data errors cause a “BULK ERROR!” message.

This index covers both the PSR-5700 “Getting Started” and “Advanced Features” manuals, so the page numbers include coded prefixes to indicate in which manual the information can be found:

GS = Getting Started
AF = Advanced Features

- A**
- A tempo GS-35
 - ABC GS-18
 - Accelerando GS-34
 - Accents AF-16
 - Accompaniment GS-18
 - Accompaniment name AF-18, 20
 - Accompaniment style AF-15
 - Accompaniment variation AF-15
 - Attack AF-29
 - Auto solo GS-24
- B**
- Bank buttons GS-13, 20
 - Bass & chord parts AF-16
 - Beat display GS-21
 - Brilliance AF-30
- C**
- Change pattern AF-23
 - Chord pads GS-30
 - Chorus GS-22
 - Cleaning GS-4
 - Clock AF-57
 - Common AF-28
 - Condition/rec type AF-7
 - Controller AF-37
 - Copy AF-22
 - Custom accompaniment edit AF-19
 - Custom accompaniment programmer AF-15
 - Custom number AF-18
 - Custom voice edit AF-27
 - Custom voice name AF-27
- D**
- Data backup GS-5
 - Data transmit AF-58
 - Decay AF-29
 - Delete all tracks AF-11
 - Delete file AF-47
 - Demo GS-10
 - Disk AF-42
 - Disk error messages AF-48
 - Disk free area AF-47
 - Disk functions AF-45
 - Disk orchestra mode voice list AF-253
 - Disk orchestra/general MIDI button AF-50
 - Disk style GS-25
 - DOC disk playback GS-40
 - DOC mode AF-52
 - DOC/GM mode AF-50
 - Drum kits GS-14
 - Drum voice edit AF-33
 - Dual detune AF-32
 - Dual mode GS-12
 - Dual name AF-30
 - Dual octave AF-31
 - Dual pan AF-32
 - Dual voice AF-31
 - Dual voice edit AF-30
 - Dual volume AF-31
- E**
- Editing procedure AF-26
 - Effect depth AF-36
 - Effect type AF-36
 - Effect wheel GS-37
 - EG rate AF-29
 - Electrical interference GS-5
 - Erase AF-12
 - Event abbreviations AF-13
 - Exit button AF-26
 - Exp. pedal select AF-38
 - Expression & effects GS-36
 - Expression pedal jack GS-9

Index

F

Fader select	AF-20
Faster	GS-35
Fill-ins	GS-23
Fingered chords	GS-18
Fingering chart	GS-178
Floppy disks	GS-5, 25
Foot switch select	AF-37
Footswitch jack	GS-8
Format disk	AF-47
From disk	AF-45
From disk button	AF-44

G

General function selection	AF-26
General MIDI	AF-51
General MIDI mode	AF-53
General MIDI mode voice list	AF-254
Glissando	GS-37
GM/DOC mode percussion map	AF-256

H

Handling & transport	GS-4
Harmony	GS-36, AF-7
Headphones	GS-8
Hertz	GS-15

I

Icons	GS-3
Initialization	GS-11
Input jacks	GS-8
Insert all tracks	AF-12
Interactive accompaniment	GS-24, AF-40
Intro, fill-in, ending patterns	AF-24
Introduction	GS-21

K

Key velocity	AF-37
Keyboard percussion	GS-14

L

Left hold	GS-36
Left-hand keyboard section	GS-22
Location	GS-4

M

Manual bass	GS-19
Manuals, about the	GS-3
Measure/beat	AF-19
Memory backup	AF-49
Metronome	AF-7
MIDI	AF-49
MIDI bulk dump	AF-58
MIDI channel setting	AF-54
MIDI connectors	GS-9
MIDI function tree	AF-242
MIDI switch	AF-56
MIDI system	AF-57
Modulation	GS-37
Modulation depth	AF-28
Modulation speed	AF-28
Multi pad mode	GS-28
Multi pad repeat playback	GS-31
Multi part setting	AF-56
Music stand	GS-9

N

Note shift	AF-14
Number buttons	GS-13, 20

O

Octave	AF-28
Octave change	GS-16
Orchestra 1 and 2	GS-13
Orchestration	GS-12
Output jacks	GS-8
Overdub recording	AF-8

P

Pads	GS-28
Pan	AF-28
Panel registration	GS-38
Perc break function	GS-33
Perc pad mode	GS-32
Perc. name	AF-33
Perc. pan	AF-34
Perc. pitch	AF-33
Perc. tone	AF-34

- Percussion instrument cancel AF-16
 Percussion map AF-255
 Phrase pads GS-28
 Pitch bend GS-37
 Pitch bend range AF-28
 Pitch bend select AF-39
 Power supply GS-4
 Punch recording AF-8
- Q**
- Quantize AF-10, 21
- R**
- Recall initial data AF-50
 Record track selection AF-4
 Recordable parameters (sequencer) AF-4
 Recording type AF-8
 Release AF-29
 Remote control mode AF-52
 Remove event AF-13, 23
 Rename file AF-46
 Replace recording AF-8
 Resonance AF-30
 Reverb GS-37
 Reverb depth AF-35
 Reverb type AF-35
 Rhythm accompaniment GS-23
 Rhythm part AF-15
 Ritardando GS-23, 35
- S**
- Save to accomp. AF-20
 Sequence editing AF-7
 Sequencer playback AF-6
 Sequencer record AF-3
 Single-finger chords GS-19
 Slower GS-35
 Solo GS-22
 Song clear AF-14
 Song number AF-3
 Split mode GS-12
 Split point AF-40
- Style list GS-20
 Super style play GS-26
 Super style play mode AF-41
 Sustain AF-29, GS-36
 Sustain jack GS-9
 Sustain part select AF-38
 Synchronized start GS-21
- T**
- Tap start GS-34
 Tempo GS-20
 Tempo change GS-34
 Tempo I GS-34
 Tempo pad mode GS-34
 Tempo synchro function GS-35
 To disk AF-46
 To disk button AF-42
 Tone AF-30
 Touch sensitivity AF-28
 Track copy/mix AF-9
 Track delete AF-5
 Transposition GS-15
 Tuning GS-15
- U**
- Utility AF-49
- V**
- Variations GS-22
 Verse GS-22
 Voice list GS-12
 Voice registration GS-17
 Voice select buttons GS-13
 Voices, selecting GS-11
 Volume AF-8, 19
 Volume settings GS-11, 13
- W**
- Wheel select AF-39

- * Values with an "H" suffix are hexadecimal.
- * Bei Werten mit dem Suffix "H" handelt es sich um Hexadezimalwerte.
- * Les valeurs précédées du suffixe "H" sont des valeurs hexadécimales.
- * Los valores con un sufijo "H" son hexadecimales.

I. Remote Control Mode

<Reception Conditions> BRch:Basic Receive Channel
 PRch:Multi Part Receive Channel
 RRch:Rhythm Receive Channel

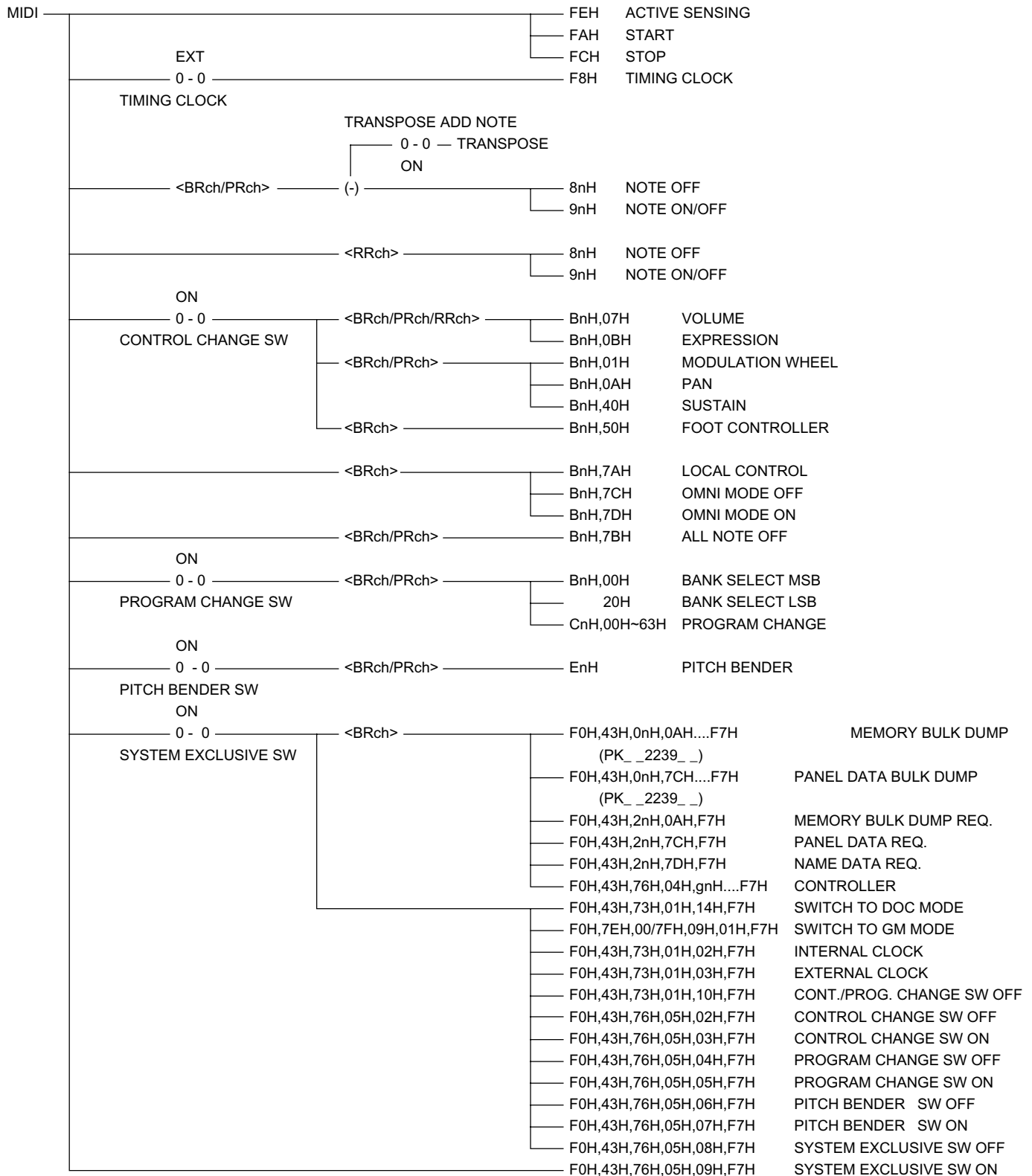

de funciones MIDI

<Transmission Conditions> Tch :Transmit Channel
 STch :Split Transmit Channel
 SeqTch:Sequencer Transmit Channel

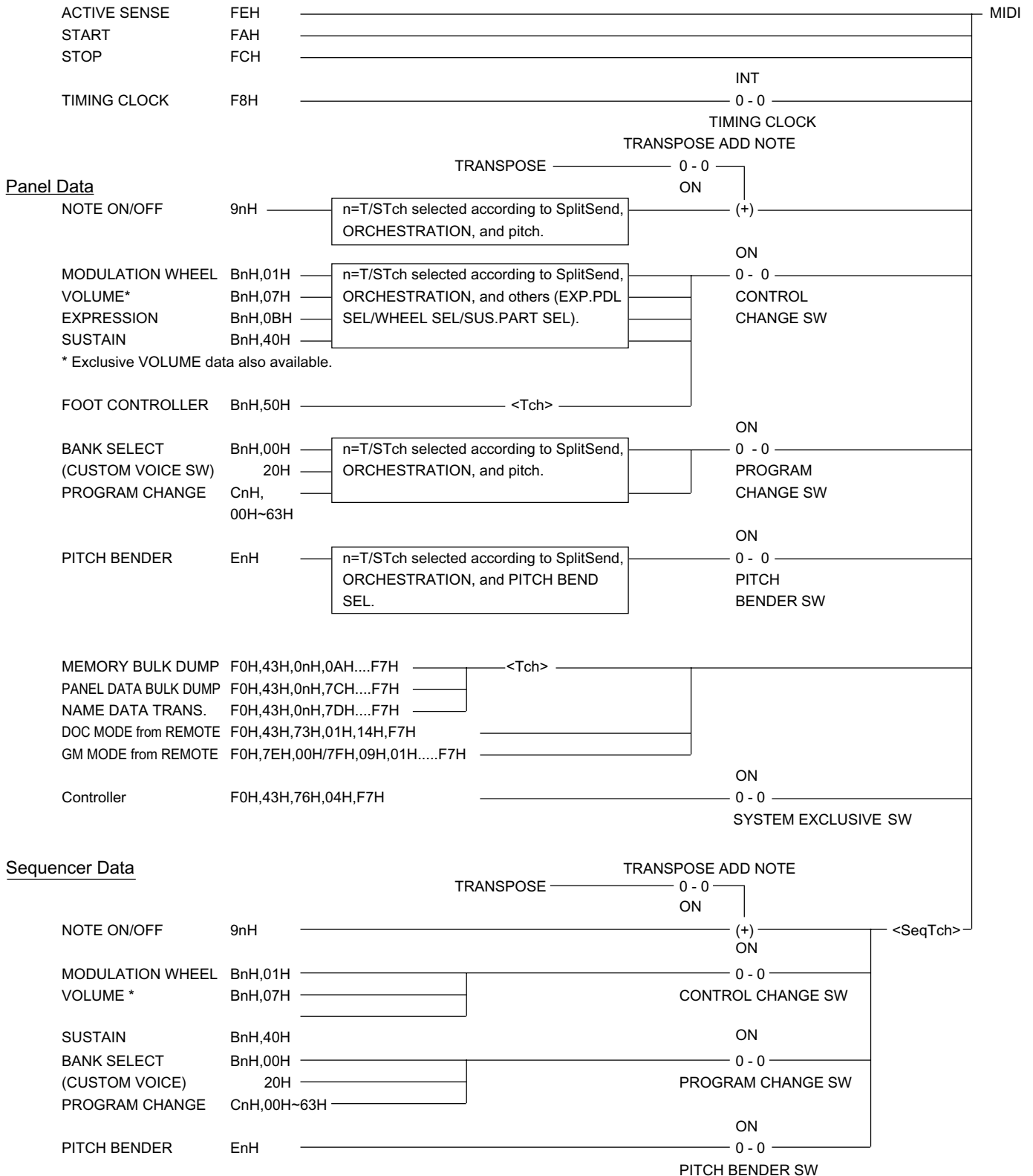

II. DOC Mode

<Reception Conditions> Kch:Key Channel

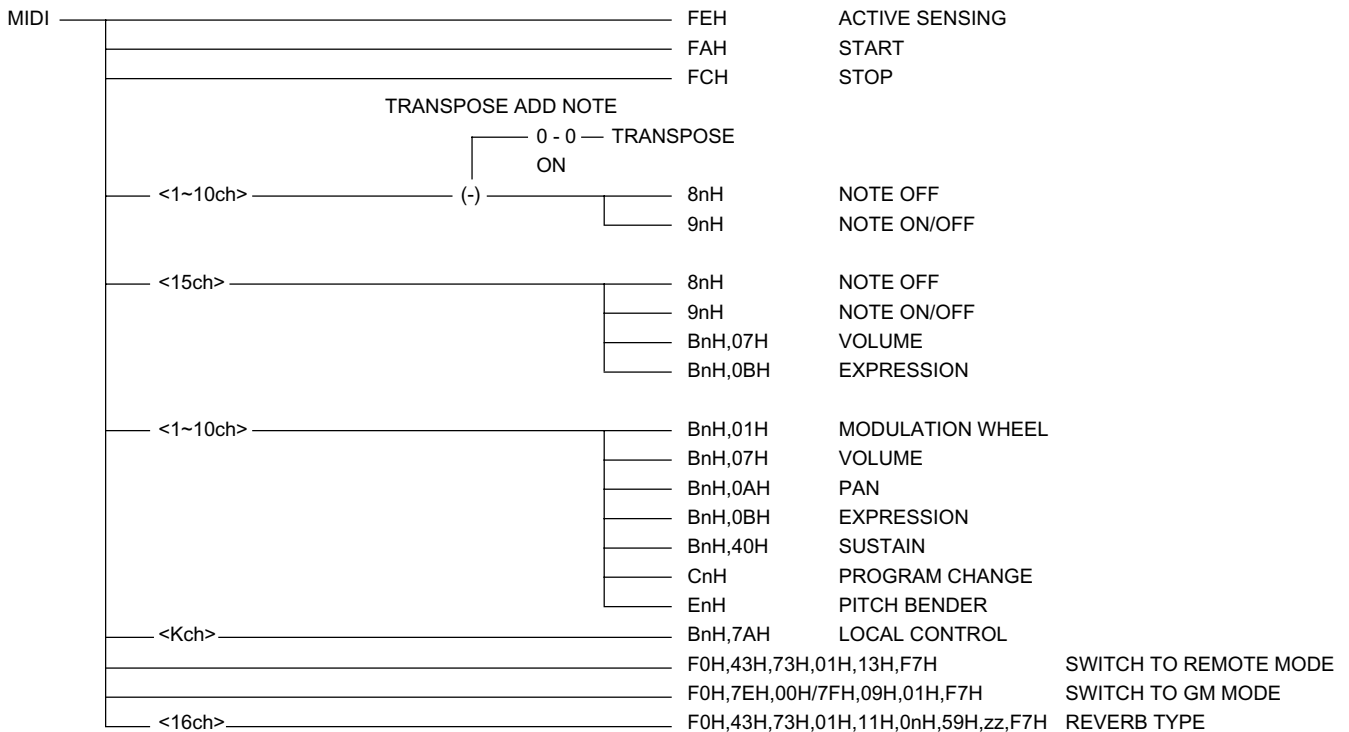

<Transmission Conditions> Kch:Key Channel

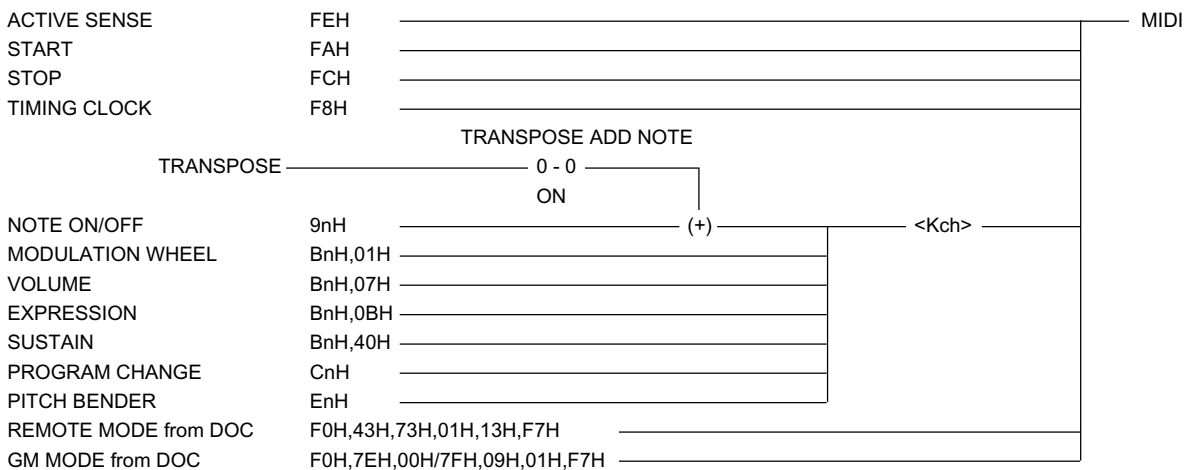

III. GM Mode

<Reception Conditions> Kch:Key Channel

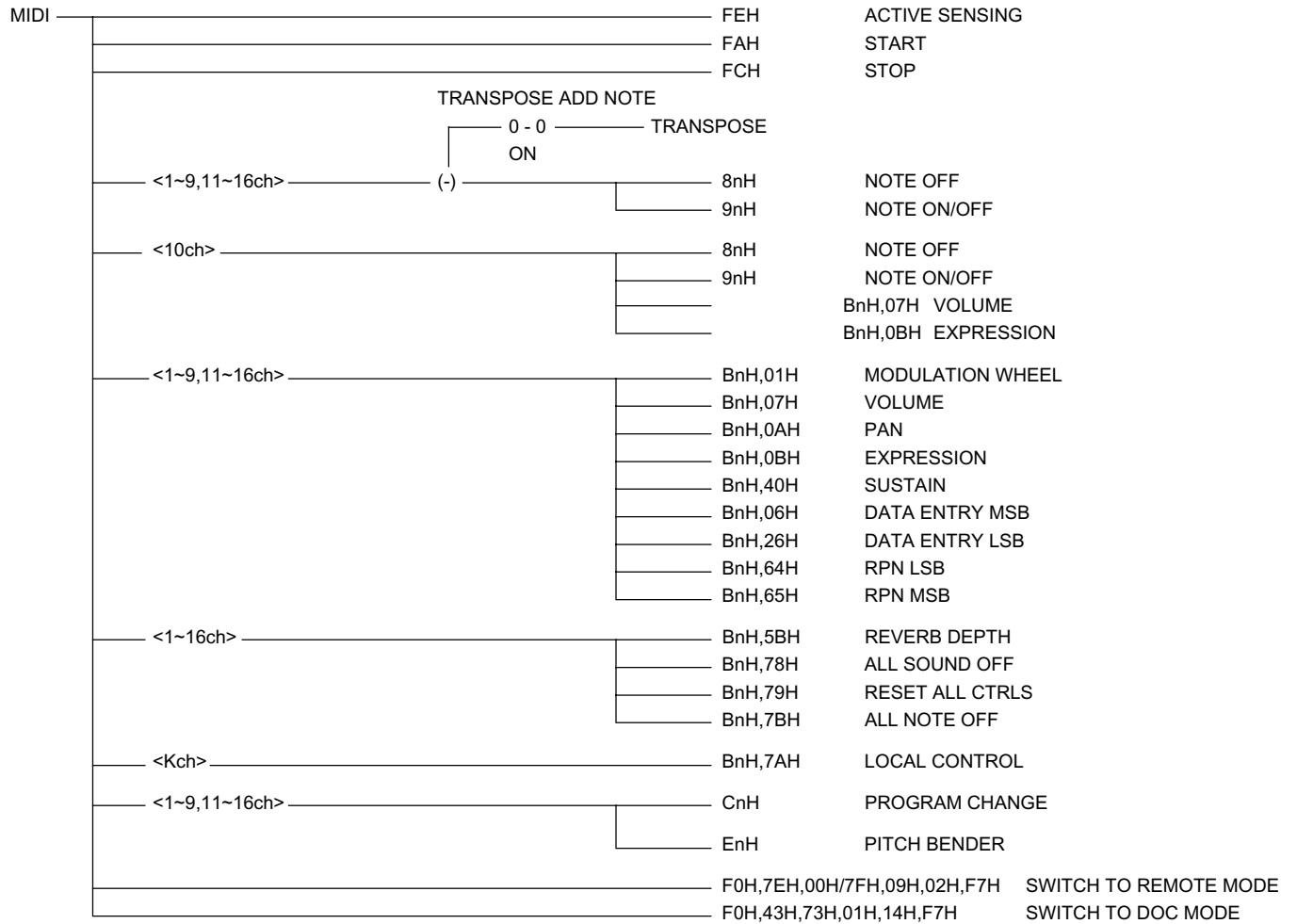

<Transmission Conditions> Kch:Key Channel

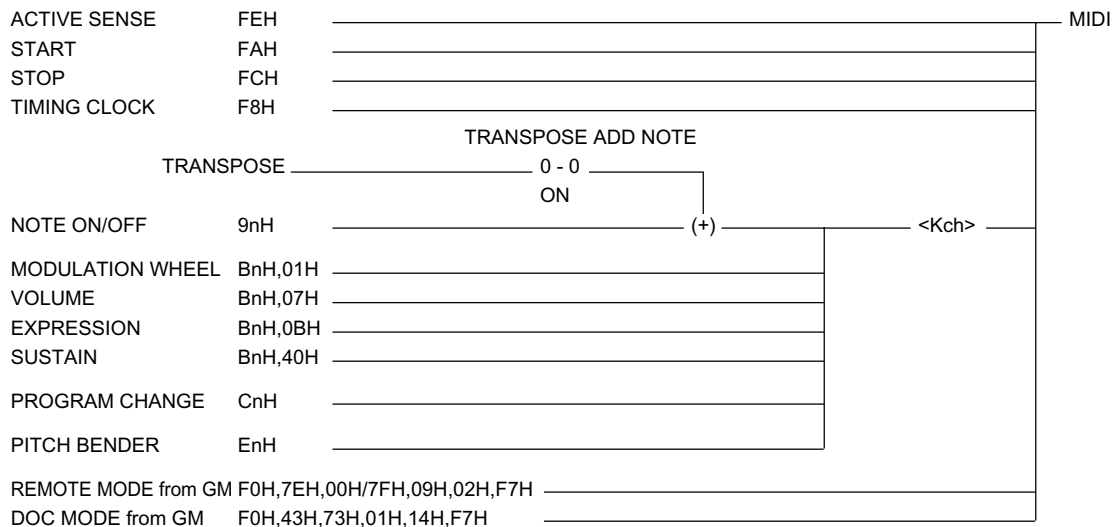

MIDI Messages • MIDI-Meldungen • Messages MIDI • Mensajes MIDI

I. Channel Message

1. VOICE MESSAGE

1-1) 8n : NOTE OFF (Reception only)

(Compatible with Remote: ○ DOC: ○ GM1: ○)

8	n
0	k
0	v

n: MIDI Channel

k: Key Note Number

v: Velocity

Velocity value ignored.

1-2) 9n : NOTE ON/OFF (Compatible with Remote: ○ DOC: ○ GM1: ○)

9	n
0	k
0	v

n: MIDI Channel

k: Key Note Number

v: Velocity 00H~7FH

Key off when velocity = 0.

1-3) Cn : PROGRAM CHANGE

(Compatible with Remote: ○ DOC: ○ GM1: ○)

C	n
0	p

n: MIDI Channel

p: Program Number

[IN/OUT]

Program Number Remote : 0~99
 DOC : 0~87 (Some numbers omitted)
 GM1 : 0~127

1-4) En : PITCH BEND CHANGE

(Compatible with Remote: ○ DOC: ○ GM1: ○)

E	n
0	LSB
0	MSB

n: MIDI Channel

MSB LSB

01111111 01111111 : max

: :

01000000 00000000 : center

: :

00000000 00000000 : min

[IN]

Pitch range. Remote : Depends on voice.
 DOC : ±300¢
 GM1 : ±200 cents default. Maximum range
 ±1 octave with RPN.

[OUT]

Pitch bend wheel value output.

1-5) Bn : CONTROL CHANGE

B	n
0	c
0	v

n: MIDI Channel

c: Control Number

v: Control Value

c=0 (Bank Select MSB) (Compatible with Remote: ○ DOC: × GM1: ×)

[IN/OUT]

v = 00H, fixed.

c=1 (Modulation Depth) (Compatible with Remote: ○ DOC: ○ GM1: ○)
 [IN]

v= Remote : Depends on voice.
 DOC : vibrato depth
 GM1 : Depends on voice.

[OUT]

v = modulation wheel value: 00H(min) ~ 7FH(max).

c=7 (Volume) (Compatible with Remote: ○ DOC: ○ GM1: ○)

[IN]

v= Remote : Corresponds to fader position.
 DOC : 7FH=0dB, 00H=-∞, 0.1875dB/step
 GM1 : 7FH=0dB, 60H=-4.8dB, 40H=-11.9dB,
 20H=-23.9dB, 10H=-36dB, 00H=-∞

[OUT]

v= Remote : Corresponds to fader position.
 DOC : Actual dB value applied to tone generator in
 0.1875 dB steps, according to fader position.
 GM1 : Inverse change applied to tone generator in dB,
 according to fader position.
 0dB=7FH, -4.8dB=60H, -11.9dB=40H,
 -23.9dB=20H,.....

c=10 (Pan) (Reception only)

(Compatible with Remote: ○ DOC: ○ GM1: ○)

[IN]

	Remote	GM1	DOC
V= 00H~07H	LEFT	7	LEFT 6
08H~0FH		6	6
10H~17H		5	6
18H~1FH		4	5
20H~27H		3	4
28H~2FH		2	3
30H~37H		1	2
38H~3FH	CENTER		1
40H	VOICE PAN		CENTER
41H~47H	CENTER		CENTER
48H~4FH	RIGHT	1	VOICE PAN
50H~57H		2	RIGHT 1
58H~5FH		3	2
60H~67H		4	3
68H~6FH		5	4
70H~77H		6	5
78H~7FH		7	6

c=11 (Expression) (Compatible with Remote: ○ DOC: ○ GM1: ○)

[IN]

v= Remote : Corresponds to expression position.
 DOC : 7FH=0dB, 00H=-∞, 0.1875dB/step
 GM1 : 7FH=0dB, 60H=-4.8dB, 40H=-11.9dB,
 20H=-23.9dB, 10H=-36dB, 00H=-∞

[OUT]

v= Remote : Corresponds to expression position.
 DOC : Actual dB value applied to tone generator in
 0.1875 dB steps, according to expression
 position.
 GM1 : Inverse change applied to tone generator in dB,
 according to expression position.
 0dB=7FH, -4.8dB=60H, -11.9dB=40H,
 -23.9dB=20h,.....

c=32 (Bank Select LSB)

(Compatible with Remote: ○ DOC: × GM1: ×)

[IN/OUT]

v= 00H: CustomVoice SW OFF
01H: CustomVoice SW ON

c=64 (Sustain)

(Compatible with Remote: ○ DOC: ○ GM1: ○)

[IN]

v= : 00H~3FH=OFF,40H~7FH=ON
(In DOC mode 00H~2FH=OFF,30H~7FH=ON)

[OUT]

v= : 00H=OFF, 7FH=ON

c=80 (Foot Controller)

(Compatible with Remote: ○ DOC: × GM1: ×)

[IN]

v= : 00H~3FH=OFF, 40H~7FH=ON

[OUT]

v= :00H=OFF, 7FH=ON

c=100(RPN LSB) (Reception only)

(Compatible with Remote: × DOC: × GM1: ○)

=101(RPN MSB)

[IN]

	MSB	LSB	Function
v=	00H	00H	Pitch Bend Sense
	00H	01H	Fine Tuning
	00H	02H	Coarse Tuning

c=6 (Data Entry MSB) (Reception only)

(Compatible with Remote: × DOC: × GM1: ○)

=38 (Data Entry LSB)

[IN]

v= Data input according to RPN, above.
Pitch Bend Sense: 1 step = 100/128 cents,
range = 0 ~ 1200 cents.
Fine Tuning: 1 step = 100/8196 cents, range = ±100 cents.
Coarse Tuning: 1 step = 100 cents, range = ±1200 cents.

c=91 (Reverb Depth) (Reception only)

(Compatible with Remote: × DOC: × GM1: ○)

v = reverb depth 00H(min) ~ 7FH(max)

2. MODE MESSAGE (Reception only)

B	n
0	c
0	v

n: MIDI Channel

c: Mode Message

v: Value

Refer to the chart below.

Mode Message	Function	Value	Remote	DOC	GM1
120	All Sound off	00H~7FH	×	×	○
121	Reset All Ctrls	00H~7FH	×	×	○
122	Local Control	00H (off), All others (on)	○	○	○
123	All Notes Off	00H	○	×	○
124	OMNI Mode Off	00H	○	×	×
125	OMNI Mode On	00H	○	×	×

II. System Message

1. REAL TIME MESSAGE

F8 : TIMING CLOCK (Compatible with Remote: ○ DOC: ○ GM1: ○)
Transmission only in DOC & GM1 modes.

FA : START (Compatible with Remote: ○ DOC: ○ GM1: ○)

FC : STOP (Compatible with Remote: ○ DOC: ○ GM1: ○)

FE : ACTIVE SENSING (Compatible with Remote: ○ DOC: ○ GM1: ○)

2. SYSTEM EXCLUSIVE MESSAGE

(1) MEMORY BULK DUMP REQUEST (Reception only)

(Compatible with Remote: ○ DOC: × GM1: ×)

11110000	F0H	Status
01000011	43H	YAMAHA ID
0010nnnn	2nH	Substatus/n: Device Number
00001010	0AH	Format Number
11110111	F7H	EOX

(2) MEMORY BULK DUMP DATA

(Compatible with Remote: ○ DOC: × GM1: ×)

11110000	F0H	Status
01000011	43H	YAMAHA ID
0000nnnn	0nH	Substatus/n: Device Number
00001010	0AH	Format Number
0nnnnnnn	nn	Byte Count MSB
0nnnnnnn	nn	Byte Count LSB
01010000	50H	Header 'P
01001011	4BH	'K
00100000	20H	space
00100000	20H	space
00110010	32H	'2
00110010	32H	'2
00110011	33H	'3
00111001	39H	'9
00100000	20H	space
0nnnnnnn	nn	Data Number*
0ddddd	dd	
:	:	Data
0ddddd	dd	
0sssssss	ss	Check-sum
11110111	F7H	EOX

* DATA NUMBER

00H	SYSTEM SET UP DATA
01H	VOICE REGISTRATION DATA
02H	PANEL REGISTRATION DATA
03H, 04H	SUPER STYLE PLAY DATA
05H~07H	PAD DATA
08H	CUSTOM VOICE DATA
09H~1AH	CUSTOM ACCOMPANIMENT DATA
1BH~2BH	SEQUENCER DATA

MIDI Messages • MIDI-Meldungen • Messages MIDI • Mensajes MIDI

(3) PANEL DATA REQUEST (Reception only)

(Compatible with Remote: O DOC: X GM1: X)

```

11110000 F0H Status
01000011 43H YAMAHA ID
0010nnnn 2nH Substatus/n: Device Number
01111100 7CH Format Number
11110111 F7H EOX
    
```

(4) PANEL DATA BULK DUMP

(Compatible with Remote: O DOC: X GM1: X)

```

11110000 F0H Status
01000011 43H YAMAHA ID
0000nnnn 0nH Substatus/n: Device Number
01111100 7CH Format Number
0nnnnnnn nn Byte Count MSB
0nnnnnnn nn Byte Count LSB
01010000 50H Header 'P
01001011 4BH 'K
00100000 20H space
00100000 20H space
00110010 32H '2
00110010 32H '2
00110011 33H '3
00111001 39H '9
00100000 20H space
00100000 20H space
0vvvvvvv vv Software Version Number
0rrrrrrr rr Software Revision Number
0ddddd dd
: : Data
0ddddd dd
0sssssss ss Check-sum
11110111 F7H EOX
    
```

(5) NAME DATA REQUEST (Reception only)

(Compatible with Remote: O DOC: X GM1: X)

```

11110000 F0H Status
01000011 43H YAMAHA ID
0010nnnn 2nH Substatus/n: Device Number
01111101 7DH Format Number
11110111 F7H EOX
    
```

(6) NAME DATA TRANSMISSION (Transmission Only)

(Compatible with Remote: O DOC: X GM1: X)

```

11110000 F0H Status
01000011 43H YAMAHA ID
0000nnnn 0nH Substatus/n: Device Number
01111101 7DH Format Number
0nnnnnnn nn Byte Count MSB
0nnnnnnn nn Byte Count LSB
01010000 50H Header 'P
01001011 4BH 'K
00100000 20H space
    
```

```

00100000 20H space
00110010 32H '2
00110010 32H '2
00110011 33H '3
00111001 39H '9
00100000 20H space
00100000 20H space
0vvvvvvv vv Software Version Number
0rrrrrrr rr Software Revision Number
0ccccc cc
0ccccc cc
0ccccc cc
0ccccc cc
0sssssss ss Check-sum
11110111 F7H EOX
    
```

Condition Data

(7) DOC/Remote Control Mode Switching

(7.1) REMOTE CONTROL MODE

(Compatible with Remote: X DOC: O GM1: X)

```

11110000 F0H Status
01000011 43H
01110011 73H
00000001 01H
00010011 13H
11110111 F7H EOX
    
```

(7.2) DOC MODE (Compatible with Remote: O DOC: X GM1: O)

```

11110000 F0H Status
01000011 43H
01110011 73H
00000001 01H
00010100 14H
11110111 F7H EOX
    
```

(8) GM Level 1/Remote Control Mode Switching

(8.1) REMOTE CONTROL MODE

(Compatible with Remote: X DOC: X GM1: O)

```

11110000 F0H Status
01111110 7EH
01111111 <Device ID> 00H or 7FH
00001001 09H
00000010 02H GM Mode Off
11110111 F7H EOX
    
```

(8.2) GM Level 1 MODE

(Compatible with Remote: O DOC: O GM1: X)

```

11110000 F0H Status
01111110 7EH
01111111 <Device ID> 00H or 7FH
00001001 09H
00000001 01H GM Mode On
11110111 F7H EOX
    
```

(9) CLOCK MODE CHANGE

(9.1) INTERNAL MODE (Reception only)

(Compatible with Remote: ○ DOC: × GM1: ×)

11110000	F0H	Status
01000011	43H	YAMAHA ID
01110011	73H	Substatus Section No.= 3 (Single Keyboard)
00000001	01H	Product ID
00000010	02H	Internal Clock Mode
11110111	F7H	EOX

(9.2) EXTERNAL MODE (Reception only)

(Compatible with Remote: ○ DOC: × GM1: ×)

11110000	F0H	Status
01000011	43H	YAMAHA ID
01110011	73H	Substatus Section No.= 3 (Single Keyboard)
00000001	01H	Product ID
00000011	03H	External Clock Mode
11110111	F7H	EOX

(10) CONTROL/PROGRAM CHANGE OFF (Reception only)

(Compatible with Remote: ○ DOC: × GM1: ×)

11110000	F0H	Status
01000011	43H	YAMAHA ID
01110011	73H	Substatus Section No.= 3 (Single Keyboard)
00000001	01H	Product ID
00010000	10H	MIDI non-sync mode on.
11110111	F7H	EOX

(11) CONTROL CHANGE OFF (Reception only)

(Compatible with Remote: ○ DOC: × GM1: ×)

11110000	F0H	Status
01000011	43H	YAMAHA ID
01110110	76H	Substatus Section No.= 6 (Portable Keyboard)
00000101	05H	
00000010	02H	Control Change Off
11110111	F7H	EOX

(12) CONTROL CHANGE ON (Reception only)

(Compatible with Remote: ○ DOC: × GM1: ×)

11110000	F0H	Status
01000011	43H	YAMAHA ID
01110110	76H	Substatus Section No.= 6 (Portable Keyboard)
00000101	05H	
00000011	03H	Control Change On
11110111	F7H	EOX

(13) PROGRAM CHANGE OFF (Reception only)

(Compatible with Remote: ○ DOC: × GM1: ×)

11110000	F0H	Status
01000011	43H	YAMAHA ID
01110110	76H	Substatus Section No.= 6 (Portable Keyboard)
00000101	05H	
00000100	04H	Program Change Off
11110111	F7H	EOX

(14) PROGRAM CHANGE ON (Reception only)

(Compatible with Remote: ○ DOC: × GM1: ×)

11110000	F0H	Status
01000011	43H	YAMAHA ID
01110110	76H	Substatus Section No.= 6 (Portable Keyboard)
00000101	05H	
00000101	05H	Program Change On
11110111	F7H	EOX

(15) PITCH BEND OFF (Reception only)

(Compatible with Remote: ○ DOC: × GM1: ×)

11110000	F0H	Status
01000011	43H	YAMAHA ID
01110110	76H	Substatus Section No.= 6 (Portable Keyboard)
00000101	05H	
00000110	06H	Pitch Bender Off
11110111	F7H	EOX

(16) PITCH BEND ON (Reception only)

(Compatible with Remote: ○ DOC: × GM1: ×)

11110000	F0H	Status
01000011	43H	YAMAHA ID
01110110	76H	Substatus Section No.= 6 (Portable Keyboard)
00000101	05H	
00000111	07H	Pitch Bender On
11110111	F7H	EOX

(17) SYSTEM EXCLUSIVE OFF (Reception only)

(Compatible with Remote: ○ DOC: × GM1: ×)

11110000	F0H	Status
01000011	43H	YAMAHA ID
01110110	76H	Substatus Section No.= 6 (Portable Keyboard)
00000101	05H	
00001000	08H	System Exclusive Off
11110111	F7H	EOX

(18) SYSTEM EXCLUSIVE ON (Reception only)

(Compatible with Remote: ○ DOC: × GM1: ×)

11110000	F0H	Status
01000011	43H	YAMAHA ID
01110110	76H	Substatus Section No.= 6 (Portable Keyboard)
00000101	05H	
00001001	09H	System Exclusive On
11110111	F7H	EOX

This command can be received even when system exclusive is OFF.

(19) REVERB TYPE

(Compatible with Remote: × DOC: ○ GM1: ×)

11110000	F0H	Status
01000011	43H	YAMAHA ID
01110011	73H	Substatus Section No.= 3 (Single Keyboard)
00000001	01H	Product ID
00010001	11H	
0000nnnn	0nH	
01011001	59H	
0zzzzzzz	zz	Reverb Type
11110111	F7H	EOX

zz =00 : OFF
01 : ROOM
02 : HALL
03 : HALL
04 : OFF

3. MIDI EXTENDED CONTROL CHANGE

Reception & Transmission Rules

- ① Only controls that are active in each mode are available for reception and transmission.
- ② As for functions, when a data entry button below the display is pressed a corresponding data entry event is transmitted rather than than the edited value.
 - Reverb and effect type/depth ON events are transmitted simultaneously.
 - Harmony type also transmitted simultaneously with an ON event.
 - ABC mode transmitted when ABC turned ON, and ABC is turned ON when an ABC mode message is received.
- ③ For controls such as the DEMO button which is held while some other operation is performed, an ON event is transmitted when the button is pressed and an OFF event is transmitted when the button is released.
- ④ OFF→ON events are transmitted in succession when an auto-repeat controller is used.

Regeln für Empfang und Übertragung

- ① Bei Empfang und Übertragung werden lediglich aktive Bedien- und Steuerelemente berücksichtigt.
- ② Bei Funktionen wird beim Betätigen einer Dateneingabetaste unter dem Display anstelle eines editierten Werts ein entsprechendes Dateneingabe-Ereignis übertragen.
 - EIN-Ereignisse (ON) für Hall- und Effektyp/-tiefe werden gleichzeitig übertragen.
 - Der Harmonietyp wird ebenfalls zusammen mit einem EIN-Ereignis (ON) übertragen.
 - Der Modus der automatischen Baß-/Akkordbegleitung wird beim Aktivieren der automatischen Baß-/Akkordbegleitung übertragen, während die automatische Baß-/Akkordbegleitung selbst beim Empfang einer entsprechenden Meldung eingeschaltet wird.
- ③ Für Bedienelemente wie die DEMO-Taste, die beim Ausführen eines anderen Vorgangs gedrückt gehalten wird, wird beim Betätigen der Taste ein EIN-Ereignis (ON) übertragen und beim Loslassen der Taste ein AUS-Ereignis (OFF).
- ④ AUS→EIN-Ereignisse werden bei Verwendung eines Reglers mit automatischer Wiederholfunktion aufeinanderfolgend übertragen.

Règles de réception et de transmission

- ① Seules les commandes active dans chaque mode sont disponibles pour la réception et la transmission.
- ② En ce qui concerne les fonctions, lorsqu'une touche d'introduction de données située sous l'affichage est sollicitée, un événement d'introduction de donnée correspondant est transmis à la place de la valeur éditée.
 - Reverb, le type/profondeur d'effet et les événements ON sont transmis simultanément.
 - Le type d'harmonie est également transmis simultanément avec l'événement ON.
 - Le mode ABC est transmis lorsque ABC est activé et ABC est activé à la réception d'un message ABC
- ③ Dans le cas de commandes telles que la touche [DEMO], qui doit maintenue enfoncée pendant que d'autres opérations sont réalisées, un événement ON est transmis lorsque la touche est enfoncée et un événement OFF lorsqu'elle est relâchée.
- ④ Les événement ON→OFF sont transmis en succession lorsqu'un contrôleur à répétition automatique est utilisé.

Reglas de recepción y transmisión

- ① Para la recepción y transmisión sólo están disponibles los controles que están activados en cada modo.
- ② En cuanto a las funciones, cuando se presiona un botón de entrada de datos de debajo del visualizador, se transmite un evento de entrada de datos correspondiente en lugar del valor editado.
 - Los eventos de activación de reverberación y tipo/profundidad de efecto se transmiten simultáneamente.
 - El tipo de armonía también se transmite simultáneamente con un evento de activación.
 - El modo ABC se transmite cuando se activa ABC, y ABC se activa cuando se recibe un mensaje del modo ABC.
- ③ Para los controles tales como el botón DEMO, que se mantiene retenido mientras se efectúa otra operación, se transmite un evento de activación cuando se presiona el botón, y un evento de desactivación cuando se suelta el botón.
- ④ Los efectos de desactivación->activación (OFF→ON) se transmiten en sucesión cuando se usa un controlador de repetición automática.

(1) 1BYTE DATA FORMAT

(O: Transmit & receive. X: No transmit or receive. R: Receive only)

11110000 F0H Status
 01000011 43H YAMAHA ID
 01110110 76H Substatus Section No.= 6 (Portable Keyboard)
 00000100 04H
 0gggnnnn gn g=0, n:Local Device Number
 0ccccccc cc cc: Controller number
 0ddddd dd Data
 11110111 F7H EOX

1BYTE DATA

g	cc	dd	Parameter	Function	Remote	DOC/GM1
0	00H	00H	PRESET 0:0	RHYTHM STYLE	O	X
		:	:			
		23H	PRESET 5:5			
		24H	CUSTOM 0			
		:	:			
		29H	CUSTOM 5			
		2AH	DISK			
	01H	00H	OFF	ABC Includes ABC ON	O	X
		01H	SF			
		02H	FC			
		03H	MB			
	03H	00H	OFF (Release button)	INTRO./FILL IN	O	X
		01H	INTRO./FILL1 ON (Press)			
		02H	INTRO./FILL2 ON (Press)			
	04H	00H	INTRO./ENDING ON (Press)	INTRO./ENDING	O	X
	05H	00H	SYNCHRO START ON (Press)	SYNCHRO START	O	X
	08H	7AH	-6	TRANSCOPE	R	X
		:	: 2's complement			
		7FH	-1 of 7 bits.			
		00H	0			
		:	:			
		06H	+6			
	0BH	01H	ORCH. 1	ORCHESTRATION	O	X
		07H	ORCH. 2+1			
	0CH	00H	ORCH. 2◀▶1	SUPER STYLE PLAY	O	X
		00H	SSP OFF			
		01H	SSP 1			
		:	:			
		04H	SSP 4			
	0DH	04H	KEY VELOCITY OFF	KEY VELOCITY	R	X
		05H	KEY VELOCITY ON			

g	cc	dd	Parameter	Function	Remote	DOC/GM1			
	0EH	00H	REVERB OFF	REVERB/EFFECT (Refer to "3 BYTE DATA" for each part) Transmitted when ON.	O	X			
		01H	REVERB ON						
		02H	REVERB TYPE 1						
		:	:						
		18H	REVERB TYPE 23						
		40H	EFFECT OFF						
		41H	EFFECT ON						
		42H	EFFECT TYPE 1						
		:	:						
		4AH	EFFECT TYPE 9						
	11H	00H	PANEL REGISTRATION A1	PANEL REGISTRATION	O	X			
		0FH	PANEL REGISTRATION B8						
	12H	01H	PAD MULTI	MULTI PAD	O	X			
		02H	PAD TEMPO						
		03H	PAD PERCUSSION						
		06H	REPEAT/SYNC/BREAK OFF						
		07H	REPEAT/SYNC/BREAK ON						
		08H	PAD REC/STOP OFF (When released)						
		09H	PAD REC/STOP ON (When pressed)						
	15H	09H	SONG SELECT 1				SEQUENCER SONG SELECT (Sequencer mode selected when received)	O	X
		:	:						
		0EH	SONG SELECT 6						
	17H	00H~7FH	CHORD 1 VOL.	CHORD 1 VOL.	O	X			
	18H	00H~7FH	BASS VOL.	BASS VOL.	O	X			
	19H	00H~7FH	RHYTHM VOL.	RHYTHM VOL.	O	X			
	1CH	00H~7FH	ORCH. 2 VOL.	ORCH. 2 VOL.	O	X			
	1DH	00H~7FH	CHORD 2 VOL.	CHORD 2 VOL.	O	X			
	1FH	00H	VOICE PART SELECT ORCH. 1	VOICE PART SELECT	O	X			
		01H	VOICE PART SELECT ORCH. 2						
	20H	00H	HARMONY OFF	HARMONY	O	X			
		01H	HARMONY ON						
		02H	HARMONY TYPE 1						
		:	:						
		11H	HARMONY TYPE 16						
	22H	00H	DEMO OFF	DEMONSTRATION	O	X			
		01H	DEMO ON						
	23H	00H	VOICE REGISTRATION 1	VOICE REGISTRATION MEMORY	O	X			
		:	:						
		09H	VOICE REGISTRATION 10						

g	cc	dd	Parameter	Function	Remote	DOC/GM1	
24H	00H	IA OFF		INTERACTIVE ACCOMPANIMENT	○	×	
	01H	IA ON					
	02H	VERSE1					
	03H	VERSE2					
	04H	CHORUS1					
	05H	CHORUS2					
	06H	SOLO OFF					
07H	SOLO ON						
25H	00H	EXIT		FUNCTION/ SEQUENCER MODE/ CUSTOM ACCOMP. MODE	○	×	
	01H	FUNCTION 1					
	:	:					
	06H	FUNCTION 6					
	07H	SEQUENCER OFF					
	08H	SEQUENCER ON					
	09H	CUS.ACCOMP. OFF					
0AH	CUS.ACCOMP. ON						
26H	02H	EDIT OFF		SEQUENCER/ CUSTOM ACCOMP.	○	×	
	03H	EDIT ON					
	04H	DELETE OFF (When released)					
	05H	DELETE ON (When pressed)					
	06H	▶▶ OFF (When released)					
07H	▶▶ ON (When pressed)						
08H	◀◀ OFF (When released)						
09H	◀◀ ON (When pressed)						
0AH	◀ ON (When pressed)						
0BH	RECORD OFF (When released)						
0CH	RECORD ON (When pressed)						
27H	00H	TRACK1/CHORD1		SEQUENCER/ CUSTOM ACCOMP.	○	×	
	:	:					
	05H	TRACK6/CHORD6					
	06H	TRACK7/BASS					
07H	ACCOMP/RHYTHM						
28H	00H	LEFT HOLD OFF		LEFT HOLD	○	×	
	01H	LEFT HOLD ON					
29H	00H	▲		PAGE/SHIFT SW	○	×	
	01H	▼					
	02H	◀					
	03H	▶					
2AH	00H	LCD SW 1 OFF (When released)		DATA ENTRY SW (Not transmitted when voice or style changed)	○	×	
	01H	LCD SW 1 ON (When pressed)					
	02H	LCD SW 2 OFF (When released)					
	03H	LCD SW 2 ON (When pressed)					
	04H	LCD SW 3 OFF (When released)					
	05H	LCD SW 3 ON (When pressed)					
	06H	LCD SW 4 OFF (When released)					
07H	LCD SW 4 ON (When pressed)						
2BH	67H	427.5Hz		PITCH TUNE	R	×	
	:	: 2's complement of 7 bits					
	7FH	439.5Hz					
	00H	440.0Hz (0.5Hz/Step)					
	:	:					
19H	452.5Hz						
2CH	00H	RE-START		RE-START	○	×	

(2) 2BYTE DATA FORMAT

(O: Transmit & receive. X: No transmit or receive. R: Receive only)

```

11110000 F0H Status
01000011 43H YAMAHA ID
01110110 76H Substatus Section No.= 6 (Portable Keyboard)
00000100 04H
Ogggnnnn gn g=1, n: Local Device Number
Occccccc cc cc: Controller number
Oddddddd dd1 Data1
Oddddddd dd2 Data2
11110111 F7H EOX
    
```

2BYTE DATA

g	cc	dd1	dd2	Parameter	Function	Remote	DOC/GM1	
1	00H	40~280		TEMPO VALUE	TEMPO	○	×	
		(Expressed in 14 bits)						
	01H	00H	00H~7FH		PAD 1	PAD ON/OFF	○	×
		01H	00H~7FH		PAD 2			
		02H	00H~7FH		PAD 3			
		03H	00H~7FH		PAD 4			
		04H	00H~7FH		PAD 5	dd2≠0: ON (Press)		
		05H	00H~7FH		PAD 6	(Release)		
		06H	00H~7FH		PAD 7			
	07H	00H~7FH		PAD 8				
02H		00H	00H~63H	PRESET VOICE	ORCH.2 VOICE	○	×	
01H	00H~63H		CUSTOM VOICE					
	03H	00H	00H~59H	PRESET VOICE	MB VOICE	○	×	
01H	00H~59H		CUSTOM VOICE					
	04H	00H	00H(Normal)	ORCH. 1	OCTAVE CHANGE	R	×	
01H	01H (1up) 7FH (1down)							
01H	00H	00H(Normal)	ORCH. 2			R	×	
01H	01H (1up) 7FH (1down)							

(3) 3BYTE DATA FORMAT

(O: Transmit & receive. X: No transmit or receive. R: Receive only)

```

11110000 F0H Status
01000011 43H YAMAHA ID
01110110 76H Substatus Section No.= 6 (Portable Keyboard)
00000100 04H
Ogggnnnn gn g=2, n: Local Device Number
Occccccc cc cc: Controller number
Oddddddd dd1 Data1
Oddddddd dd2 Data2
Oddddddd dd3 Data3
11110111 F7H EOX
    
```

3BYTE DATA

g	cc	dd1	dd2	dd3	Parameter	Function	Remote	DOC/GM1
2	00H	00H	00H~07H	01H	RHYTHM	Reverb depth.	○	×
		01H	00H~07H	01H	BASS			
		02H	00H~07H	01H	CHORD2			
		03H	00H~07H	01H	CHORD1			
		04H	00H~07H	01H	ORCH. 2			
	05H	00H~07H	01H	ORCH. 1	Values for all parts transmitted when reverb is turned ON.			
	01H	01H	00H~07H	01H	BASS	Effect depth.	○	×
		02H	00H~07H	01H	CHORD2			
		03H	00H~07H	01H	CHORD1			
		04H	00H~07H	01H	ORCH. 2			
05H		00H~07H	01H	ORCH. 1	Values for all parts transmitted when effect is turned ON.			

DISK ORCHESTRA (DOC) Mode Voice List
Stimmenverzeichnis für DOC-Modus (Disk Orchestra Collection)
Liste des voix du mode DISK ORCHESTRA (DOC)
Lista de Voces del modo DISK ORCHESTRA (DOC)

Number	Name	Display	Number	Name	Display
00	BRASS	Brass	44	SYNTH WOOD	Syn.Wood
01	TRUMPET	Trumpet	45	SYNTH STRINGS	Syn.Str
02	FRENCH HORN	Fr.Horn	46	SYNTH CHOIR	SynChoir
03	SAX 1	Sax 1	47	PIANO 1	Piano 1
04	CLARINET	Clarinet	48	PIANO 2	Piano 2
05	OBOE	Oboe	49	HONKY-TONK PIANO	HnkyTonk
06	FLUTE 1	Flute 1	50	ELECTRIC PIANO 2	E.Piano2
07	ACCORDION	Acordion	51	BRIGHT PIANO	BritePno
08	STRINGS 1	Strings1	52	BRIGHT PIANO	BritePno
09	VIOLIN 1	Violin 1	53	FOLK GUITAR	Folk Gtr
10	FULL ORGAN	FullOrgn	54	ROCK GUITAR 1	RockGtr1
11	JAZZ ORGAN 1	JazzOrg1	55	BANJO	Banjo
12	PIANO 1	Piano 1	56	PIZZICATO STRINGS	Pizz.Str
13	ELECTRIC PIANO 1	E.Piano1	57	HARP	Harp
14	HARPSICHORD	Harpsi.	58	STEEL DRUM	SteelDrum
15	CELESTA	Celesta	59	—	—
16	VIBES	Vibes	60	BRASS DECAY	Brass D.
17	MARIMBA	Marimba	61	FLUTE DECAY	Flute D.
18	CLAVI	Clavi	62	STRINGS DECAY	StringsD
19	GLOCKEN	Glocken	63	CHOIR DECAY	Choir D.
20	SYNTH BRASS	SynBrass	64	FULL ORGAN DECAY	FullOrgD
21	—	—	65	JAZZ ORGAN DECAY	JazzOrgD
22	CRYSTAL	Crystal	66	SYNTH BRASS DECAY	SynBrasD
23	TIMPANI	Timpani	67	SAX DECAY	Sax D.
24	GUT GUITAR	Gut Gtr	68	CLAVINOVA TONE	Clavnova
25	JAZZ GUITAR 1	JazzGtr1	69	ROCK GUITAR 2	RockGtr2
26	ROCK GUITAR 1	RockGtr1	70	MUTE GUITAR	Mute Gtr
27	SITAR	Sitar	71	ACOUSTIC BASS 2	Aco.Bas2
28	ACOUSTIC BASS 1	Aco.Bas1	72	JAZZ GUITAR 2	JazzGtr2
29	ELECTRIC BASS 1	E.Bass 1	73	POP BRASS	PopBrass
30	ELECTRIC BASS 2	E.Bass 2	74	STRINGS 2	Strings2
31	SYNTH BASS	Syn.Bass	75	VIOLIN 2	Violin 2
32	—	—	76	ORGAN	Organ
33	—	—	77	SAX 2	Sax 2
34	—	—	78	ELECTRIC BASS 3	E.Bass 3
35	—	—	79	FLUTE 2	Flute 2
36	—	—	80	BASSOON	Bassoon
37	—	—	81	CHAMBER STRINGS	Chamber
38	—	—	82	JAZZ ORGAN 2	JazzOrg2
39	—	—	83	—	—
40	MUTE TRUMPET	Mute Trp	84	—	—
41	HARMONICA	Hamonica	85	—	—
42	CHOIR	Choir	86	—	—
43	JAZZ ORGAN 1	JazzOrg1	87	ORCHESTRA HIT	Orch.Hit

GENERAL MIDI (GM) Mode Voice List • Stimmenverzeichnis für GM-Modus (General MIDI)

Liste des voix du mode GENERAL MIDI (GM) • Lista de voces del modo GENERAL MIDI (GM)

Number	Group	Name (GM)	Display	Number	Group	Name (GM)	Display
01	Piano	Acoustic Grand Piano	GrandPno	65	Reed	Soprano Sax	SprnoSax
02		Bright Acoustic Piano	BritePno	66		Alto Sax	Alto Sax
03		Electric Grand Piano	E.Grand	67		Tenor Sax	TenorSax
04		Honky-tonk Piano	HnkyTonk	68		Baritone Sax	Bari.Sax
05		Electric Piano 1	E.Piano1	69		Oboe	Oboe
06		Electric Piano 2	E.Piano2	70		English Horn	Eng.Horn
07		Harpsichord	Harpsi.	71		Bassoon	Bassoon
08		Clavi	Clavi.	72		Clarinet	Clarinet
09	Chromatic Percussion	Celesta	Celesta	73	Pipe	Piccolo	Piccolo
10		Glockenspiel	Glocken	74		Flute	Flute
11		Music Box	MusicBox	75		Recorder	Recorder
12		Vibraphone	Vibes	76		Pan Flute	PanFlute
13		Marimba	Marimba	77		Blown Bottle	Bottle
14		Xylophone	Xylophon	78		Shakuhachi	Shakhchi
15		Tubular Bells	TubulBel	79		Whistle	Whistle
16		Dulcimer	Dulcimer	80		Ocarina	Ocarina
17	Organ	Drawbar Organ	DrawOrgn	81	Synth Lead	Lead 1 (square)	SquareLd
18		Percussive Organ	PercOrgn	82		Lead 2 (sawtooth)	Saw.Lead
19		Rock Organ	RockOrgn	83		Lead 3 (calliope)	CaliopLd
20		Church Organ	ChrchOrg	84		Lead 4 (chiff)	Chiff Ld
21		Reed Organ	ReedOrgn	85		Lead 5 (charang)	CharanLd
22		Accordion	Acordion	86		Lead 6 (voice)	Voice Ld
23		Harmonica	Harmonica	87		Lead 7 (fifths)	Fifth Ld
24		Tango Accordion	TangoAcid	88		Lead 8 (bass+lead)	Bass &Ld
25	Guitar	Acoustic Guitar (nylon)	NylonGtr	89	Synth Pad	Pad 1 (new age)	NewAgePd
26		Acousitic Guitar (steel)	SteelGtr	90		Pad 2 (warm)	Warm Pad
27		Electric Guitar (jazz)	Jazz Gtr	91		Pad 3 (polysynth)	PolySyPd
28		Electric Guitar (clean)	CleanGtr	92		Pad 4 (choir)	ChoirPad
29		Electric Guitar (muted)	Mute.Gtr	93		Pad 5 (bowed)	BowedPad
30		Overdriven Guitar	Ovrdrive	94		Pad 6 (metallic)	MetalPad
31		Distortion Guitar	Dist.Gtr	95		Pad 7 (halo)	Halo Pad
32		Guitar Harmonics	GtrHarmo	96		Pad 8 (sweep)	SweepPad
33	Bass	Acoustic Bass	Aco.Bass	97	Synth Effects	FX 1 (rain)	Rain
34		Electric Bass (finger)	FngrBass	98		FX 2 (soundtrack)	SoundTrk
35		Electric Bass (pick)	PickBass	99		FX 3 (crystal)	Crystal
36		Fretless Bass	Fretless	100		FX 4 (atmosphere)	Atmosphr
37		Slap Bass 1	SlapBas1	101		FX 5 (brightness)	Bright
38		Slap Bass 2	SlapBas2	102		FX 6 (goblins)	Goblins
39		Synth Bass 1	SynBass1	103		FX 7 (echoes)	Echoes
40		Synth Bass 2	SynBass2	104		FX 8 (sci-fi)	SF
41	Strings	Violin	Violin	105	Ethnic	Sitar	Sitar
42		Viola	Viola	106		Banjo	Banjo
43		Cello	Cello	107		Shamisen	Shamisen
44		Contrabass	ContraBs	108		Koto	Koto
45		Tremolo Strings	Trem.Str	109		Kalimba	Kalimba
46		Pizzicato Strings	Pizz.Str	110		Bagpipe	Bagpipe
47		Orchestral Harp	Harp	111		Fiddle	Fiddle
48		Timpani	Timpani	112		Shanai	Shanai
49	Ensemble	String Ensemble 1	Strings1	113	Percussive	Tinkle Bell	TnkIBell
50		String Ensemble 2	Strings2	114		Agogo	Agogo
51		Synth Strings 1	Syn.Str1	115		Steel Drums	SteelDrm
52		Synth Strings 2	Syn.Str2	116		Woodblock	WoodBlok
53		Choir ∞hs	Choir∞h	117		Taiko Drum	TaikoDrm
54		Voice Oohs	VoiceOoh	118		Melodic Tom	MelodTom
55		Synth Voice	SynVoice	119		Synth Drum	Syn.Drum
56		Orchestra Hit	Orch.Hit	120		Reverse Cymbal	RevCymbL
57	Brass	Trumpet	Trumpet	121	Sound Effects	Guitar Fret Noise	FretNoiz
58		Trombone	Trombone	122		Breath Noise	BrthNoiz
59		Tuba	Tuba	123		Seashore	Seashore
60		Muted Trumpet	Mute.Trp	124		Bird Tweet	Tweet
61		French Horn	Fr.Horn	125		Telephone Ring	Telephone
62		Brass Section	BrasSect	126		Helicopter	Helicptr
63		Synth Brass 1	SynBras1	127		Applause	Applause
64		Synth Brass 2	SynBras2	128		Gunshot	Gunshot

PSR-5700 Percussion Map • PSR-5700 Schlagzeugklang-Verzeichnis

Carte de batterie du PSR-5700 • Mapa de percusión del PSR-5700

* refer to this map when receiveing MIDI data on the rhythm channel.

* Richten Sie sich zum Empfang von MIDI-Daten auf dem Rhythmuskanal nach diesem Verzeichnis.

* Reportez-vous à cette carte en cas de réception de données MIDI sur le canal de rythme

* consulte este mapa para recibir datos MIDI en el canal de ritmo.

Key (MIDI) Number	Note	Name
12	C-1	Hand Claps
13	D \flat -1	Triangle Close
14	D-1	Whistle Low
15	E \flat -1	Triangle Open
16	E-1	Whistle Hi
17	F-1	Kick 5
18	F#-1	Kick 6
19	G-1	Kick 7
20	A \flat -1	Kick 8
21	A-1	Tom Bass
22	B \flat -1	Rim Shot 2
23	B-1	Tom Low
24	C0	Tom Mid
25	D \flat 0	Snare 7
26	D0	Tom Hi
27	E \flat 0	Snare 8
28	E0	Snare 9
29	F0	Snare 3
30	F#0	Snare 10
31	G0	Snare 11
32	A \flat 0	Brush Hit 2
33	A0	Snare Roll
34	B \flat 0	Snare Brush Squeeze
35	B0	Pedal Hi-Hat 2
36	C1	Applause
37	D \flat 1	Triangle Close
38	D1	Whistle Low
39	E \flat 1	Triangle Open
40	E1	Whistle Hi
41	F1	Kick 1
42	F#1	Kick 2
43	G1	Kick 3
44	A \flat 1	Kick 4
45	A1	Tom 1 Bass
46	B \flat 1	Rim Shot 1
47	B1	Tom 1 Low
48	C2	Tom 1 Mid
49	D \flat 2	Snare 1
50	D2	Tom 1 Hi

Key (MIDI) Number	Note	Name
51	E \flat 2	Snare 2
52	E2	Snare 3
53	F2	Snare 4
54	F#2	Snare 5
55	G2	Snare 6
56	A \flat 2	Brush Hit 1
57	A2	Snare Roll
58	B \flat 2	Snare Brush Squeeze
59	B2	Pedal Hi-Hat 1
60	C3	Closed Hi-Hat 1
61	D \flat 3	Timbales Low
62	D3	Open Hi-Hat 1
63	E \flat 3	Timbales Hi
64	E3	Closed Hi-Hat 2
65	F3	Open Hi-Hat 2
66	F#3	Conga 1 Low
67	G3	Ride Cymbal 1
68	A \flat 3	Conga 1 Hi
69	A3	Ride Cup 1
70	B \flat 3	Conga 1 Mute
71	B3	Crash Cymbal 1
72	C4	Crash Cymbal 2
73	D \flat 4	Bongo Low
74	D4	Splash Cymbal
75	E \flat 4	Bongo Hi
76	E4	March Cymbal
77	F4	Surdo
78	F#4	Cabasa
79	G4	Tom Brush Low
80	A \flat 4	Vibraslap
81	A4	Tom Brush Mid
82	B \flat 4	Claves
83	B4	Tom Brush Hi
84	C5	Guiro Long
85	D \flat 5	Cuica Low
86	D5	Guiro Short
87	E \flat 5	Cuica Hi
88	E5	Tambourine
89	F5	Cowbell Low

Key (MIDI) Number	Note	Name
90	F#5	Agogo Low
91	G5	Castanet
92	A \flat 5	Agogo Hi
93	A5	Finger Snaps
94	B \flat 5	Cross Sticks
95	B5	—
96	C6	Closed Hi-Hat 2
97	D \flat 6	Timbales Low
98	D6	Open Hi-Hat 2
99	E \flat 6	Timbales Hi
100	E6	Closed Hi-Hat 3
101	F6	Open Hi-Hat 3
102	F#6	Conga 2 Low
103	G6	Ride Cymbal 2
104	A \flat 6	Conga 2 Hi
105	A6	Ride Cup 2
106	B \flat 6	Conga 2 Mute
107	B6	Crash Cymbal 1
108	C7	Crash Cymbal 2
109	D \flat 7	Bongo Low
110	D7	Chinese Cymbal
111	E \flat 7	Bongo Hi
112	E7	Reverse Cymbal
113	F7	E.Tom Bass
114	F#7	Maracas
115	G7	E.Tom Low
116	A \flat 7	Vibraslap
117	A7	E.Tom Mid
118	B \flat 7	Wood Block
119	B7	E.Tom Hi
120	C8	Guiro Long
121	D \flat 8	Scratch Noise Low
122	D8	Guiro Short
123	E \flat 8	Scratch Noise Hi
124	E8	Running Water
125	F8	Cowbell Hi
126	F#8	Agogo Low
127	G8	Dropping Coin

- C1 ... B5 are included in voice number 98 Drum Kit.
- C-1 ... B0 are the lower 2 octaves on voice number 99 Pop Drum Kit (C1 ... B2).
C6 ... G8 are the upper 2.5 octaves (C3 ... G5).
- A \flat 5 ... C6 are included in both voice numbers 98 Drum Kit and 99 Pop Drum Kit.

- C1 ... B5 sind Teil der "Schlagzeug-Stimme" DRUM KIT (Nr. 98).
- C1 ... B0 entsprechen den unteren beiden Oktaven bei der "Schlagzeugstimme" POP DRUM KIT (Nr. 99) (C1 ... B2).
C6 ... B8 entsprechen den oberen zweieinhalb Oktaven (C3 ... G5).
- A \flat 5 ... C6 sind Teil beider "Schlagzeug-Stimmen", DRUM KIT (Nr. 98) und POP DRUM KIT (Nr. 99).

- C1 ... B5 inclus dans la voix 98 Drum Kit.
- C-1 ... B0 sont les 2 octaves les plus basses de la voix numéro 99 Pop Drum Kit (C1 ... B2).
C6 ... G8 sont les 2,5 octaves les plus hautes (C3 ... G5).
- A \flat 5 ... C6 inclus dans les deux voix 98 Drum Kit et 99 Pop Drum Kit.

- C1 ... B5 se incluyen en el número de voz 98 Drum Kit.
- C1 ... B0 son las 2 octavas inferiores del número de voz 99 Pop Drum Kit (C1 ... B2).
C6 ... G8 son las 2,5 octavas superiores (G3 ... G5).
- A \flat 5 ... C6 se incluyen en los números de voz 98 Drum Kit y 99 Pop Drum Kit.

GM/DOC MODE Percussion Map • Schlagzeugklang-Verzeichnis für DOC/GM-Modus

Carte de batterie en mode DOC/GM • Mapa de percusión del modo DOC/GM MODE

Key (MIDI) Number	Note	GM Name	DOC Name
30	F#0	—	Snare Brush
31	G0	—	—
32	A♭0	—	Closed Hi-Hat Heavy
33	A0	—	—
34	B♭0	—	Crash Cymbal Light
35	B0	Acoustic Bass Drum	Bass Drum Light
36	C1	Bass Drum 1	Snare Drum+Rim Heavy
37	D♭1	Side Stick	Ride Cup
38	D1	Acoustic Snare	Snare Drum+Rim Light
39	E♭1	Hand Clap	—
40	E1	Electric Snare	—
41	F1	Low Floor Tom	Bass Drum
42	F#1	Closed Hi-Hat	Rim Shot
43	G1	High Floor Tom	Snare Drum Heavy
44	A♭1	Pedal Hi-Hat	Snare Brush Shot
45	A1	Low Tom	Snare Drum Light
46	B♭1	Open Hi-Hat	Pedal Hi-Hat
47	B1	Low-Mid Tom	Snare Drum Echo
48	C2	Hi-Mid Tom	Tom 4
49	D♭2	Crash Cymbal 1	Closed Hi-Hat
50	D2	High Tom	Tom 3
51	E♭2	Ride Cymbal 1	Open Hi-Hat
52	E2	Chinese Cymbal	Tom 2
53	F2	Ride Bell	Tom 1
54	F#2	Tambourine	Ride Cymbal
55	G2	Splash Cymbal	Electronic Tom 3
56	A♭2	Cowbell	Crash Cymbal
57	A2	Crash Cymbal 2	Electronic Tom 2
58	B♭2	Vibraslap	Crash Cymbal
59	B2	Ride Cymbal 2	Electronic Tom 1
60	C3	Hi Bongo	Conga Low
61	D♭3	Low Bongo	Cabasa
62	D3	Mute Hi Conga	Conga High
63	E♭3	Open Hi Conga	Metronome
64	E3	Low Conga	Bongo
65	F3	High Timbale	Timbale Low
66	F#3	Low Timbale	Claves
67	G3	High Agogo	Timbale High
68	A♭3	Low Agogo	Castanets
69	A3	Cabasa	Cuica Low
70	B♭3	Maracas	Cowbell
71	B3	Short Whistle	Cuica High
72	C4	Long Whistle	Hand Claps
73	D♭4	Short Guiro	Agogo Low
74	D4	Long Guiro	—
75	E♭4	Claves	Agogo High
76	E4	Hi Wood Block	Bongo Low
77	F4	Low Wood Block	Cuica Low
78	F#4	Mute Cuica	Tambourine
79	G4	Open Cuica	Crash Cymbal
80	A♭4	Mute Triangle	Triangle Closed
81	A4	Open Triangle	Snare Brush
82	B♭4	—	Triangle Open

Function	Transmitted	Recognized	Remarks
Basic Default	1-16	1-16	memorized
Channel Changed	1-16	1-16	
Mode Default	3	1,3	*2 memorized
Mode Messages	X	OMNION,OMNIOFF	
Mode Altered	*****	X	
Note Number : True voice	36-96 *****	0-127 0-127	
Velocity Note on	0 9nH,v=1-127	0 v=1-127	
Velocity Note off	X 9nH,v=0	X	
After Key's	X	X	
Touch Ch's	X	X	
Pitch Bender	0	0 0-12 semi	*1:7bit resolution
Control Change	0,32 : 0 1 : 0 6,38 : X 7 : 0 10 : X 11 : 0 64 : 0 80 : 0 91 : X 100,101 : X 120 : X 121 : X	*2 : 0 : 0 : 0 : 0 : 0 : 0 *2 : 0 : 0 : 0 *3 : 0 *3 : 0 *3 : 0 *3 : 0	*2 : Bank Select : Modulation *3 : Data Entry : Volume : Pan : Expression : Sustain *2 : Foot Controller *3 : Reverb Depth *3 : RPN LSB,MSB *3 : All Sound Off *3 : Reset All Ctrls
Program Change : True #	0 0-99 *****	*4 : 0 0-99 0-99	*4 : *4 : *4 :
System Exclusive	0	0	
System : Song Pos	X	X	
System : Song.Sel	X	X	
Common : Tune	X	X	
System :Clock	0	0	*2
Real Time:Commands	0	0	
Aux :Local ON/OFF	X	0	
Aux :All Notes OFF	X	0 (122-125)	*5
Mes- :Active Sense	0	0	
sages:Reset	X	X	
Notes	*1 = 0-3 if DOC mode is on *2 = only remote control mode *3 = only GM mode *4 = 0-127 if GM mode is on 0-87 if DOC mode is on *5 = 122-123 if GM mode is on 122 if DOC mode is on		

Specifications • Technische Daten • Spécifications • Especificaciones

KEYBOARD:

61 Keys (C1~C6) with Touch Response

POLYPHONY:

38 notes max.

VOICES:

Preset 100 voices

Custom 100 voices (Programmable)

ACCOMPANIMENT:

INTERACTIVE ACCOMPANIMENT:

Preset 36 styles

Disk 1 style

* 5 variations for each style

CUSTOM ACCOMPANIMENT:

6 styles + INTRO/FILL/ENDING (Programmable)

SUPER STYLE PLAY:

Preset 36 styles

Disk 1 style

* 4 variations for each style

EFFECT:

Reverb based effect 23 types, Chorus based effect 9 types,
Harmony 16 types

PERCUSSION:

Keyboard; 92 (Percussion + Sound Effect)

PAD:

8 (MULTI/PERC./TEMPO)

AUTO BASS CHORD:

Single Finger, Fingered Chord, Manual Bass

SEQUENCER:

8 Tracks, 6 Songs

REGISTRATION:

VOICE REGISTRATION: 10

PANEL REGISTRATION: 16

DISPLAY:

LED, LCD

DISK DRIVE:

3.5" FDD, Compatibility with DOC (Yamaha Disk Orchestra
Collection) and General MIDI software

DEMONSTRATION:

4 Songs

CONNECTORS:

MIDI (IN/OUT/THRU), FOOT SW., SUSTAIN, EXP. PEDAL,
HEADPHONES, AUX. IN (R, L/L+R), AUX. OUT (R, L/L+R)

AMPLIFIER:

10W x 2

SPEAKERS:

16cm (6-5/16") x 2, 5cm (1-5/16") x 2

DIMENSIONS (W x D x H):

1067mm (42") x 409mm (16-1/8") x 160mm (6-5/16")

WEIGHT:

15.0 kg (33.1lbs.)

SUPPLIED ACCESSORIES:

- Music Stand
- FC5 Foot Switch
- Sample Data Disk
- "Getting Started" Manual
- "Advanced Features" Manual

* Specifications subject to change without notice.



YAMAHA