



IN-CEILING SPEAKER
ENCEINTE ENCASTRABLE POUR PLAFOND

NS-IC400

OWNER'S MANUAL
MODE D'EMPLOI
BEDIENUNGSANLEITUNG
MANUALE DI ISTRUZIONI
MANUAL DE INSTRUCCIONES
ИНСТРУКЦИЯ ПО ЭКСПЛУАТАЦИИ
使用说明书

CONSUMER PRECAUTIONS

Read these precautions carefully before setting up your NS-IC400 speakers.

- When mounting these speakers, be sure to work with two or more persons for safety.
- Do not attach them to thin plywood or soft ceiling surface materials as the screws may tear free, causing the speakers to fall and become damaged, or result in personal injury.
- Do not fasten the speakers to a ceiling with nails, adhesives, or other unsafe hardware. Long-term use and vibrations may cause them to pull free.
- Do not place the speakers where they are liable to be knocked over or struck by falling objects. Stable placement will also ensure better sound performance.
- Do not attempt to modify or fix the speakers. Contact qualified Yamaha service personnel when any service is needed.
- Do not attempt to clean the speakers with chemical solvents as this might damage the finish. To clean, wipe with a dry, soft cloth.
- **Secure placement or installation is the owner's responsibility. Yamaha shall not be liable for any accident caused by improper placement or installation of speakers.**

Information for Users on Collection and Disposal of Old Equipment



This symbol on the products, packaging, and/or accompanying documents means that used electrical and electronic products should not be mixed with general household waste.

For proper treatment, recovery and recycling of old products, please take them to applicable collection points, in accordance with your national legislation and the Directives 2002/96/EC.

By disposing of these products correctly, you will help to save valuable resources and prevent any potential negative effects on human health and the environment which could otherwise arise from inappropriate waste handling.

For more information about collection and recycling of old products, please contact your local municipality, your waste disposal service or the point of sale where you purchased the items.

[Information on Disposal in other Countries outside the European Union]

This symbol is only valid in the European Union. If you wish to discard these items, please contact your local authorities or dealer and ask for the correct method of disposal.

CONTENTS

CONSUMER PRECAUTIONS.....	1
CONTENTS.....	2
PREPARATION.....	2
Optimum installation layout.....	2
INSTALLATION.....	5
Before installation.....	5
How to install.....	6
CONNECTING YOUR AMPLIFIER/RECEIVER.....	9
Connections.....	9
How to connect.....	9
After connecting.....	10
PAINTING THE SPEAKER GRILLE.....	10
SPECIFICATIONS.....	10

PREPARATION

Optimum installation layout

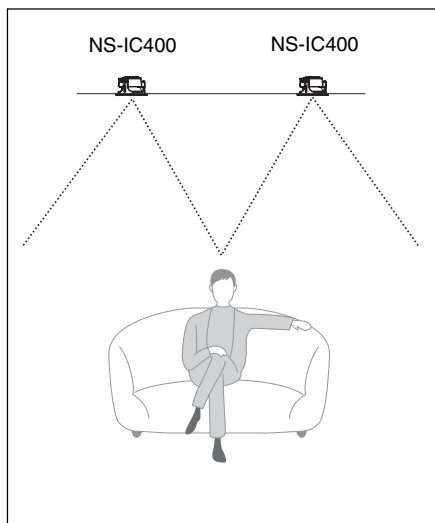

Stereo

For best stereo performance, install the left and right speakers at equal distance from the listening position. Each speaker should be separated by a distance of 1.8 – 3.0 m (6 – 10 ft).

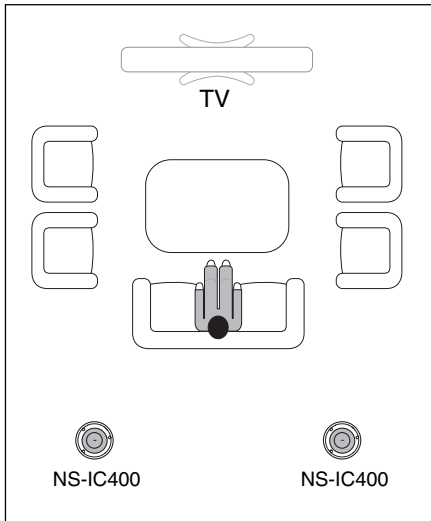
**Home Theater (when using as surround speakers)**

Use these speakers for left and right surround channels. Surround speakers should ideally be placed behind the listening area, at least as far apart as the front speakers and up to 60 additional centimeters (2 additional feet) apart per side.

Example Installation

Laundry room

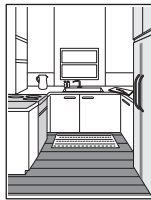

Kitchen

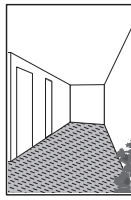

Hallway

With the compact design, it can be easily installed into ceilings and walls with little clearance space. It can also fit into corners, hallways, closets, and other places which would normally be too small for speaker.

- Do not place the speaker in a location where foreign objects such as water drops may come into contact with the speaker or near heat/moisture. This may cause the speaker to malfunction.

Unpacking

After unpacking, check that the following items are contained.

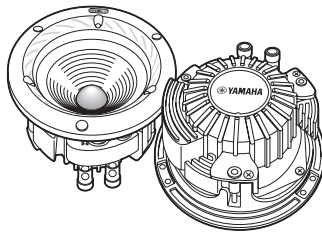

NS-IC400
Speaker × 2

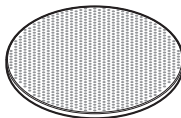

Speaker grille × 2

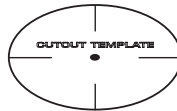

Cutout template × 1

Tools needed for installation

When installing the speakers to the ceiling, you will need to prepare the following tools.

* Use an appropriate tool for the material of the mounting surface.



Pencil

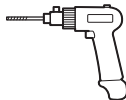

Drill

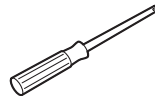

Philips
screwdriver



Wire strippers



Safety goggles



Keyhole saw



Sturdy wire
(such as a coat hanger)



Gloves

INSTALLATION

Before installation

The following is the recommended procedure for installing the speakers in a ceiling. Please read it carefully before installation.

- Before you begin installation, read this owner's manual completely and consult your local building codes. If you have any doubt, contact your dealer or a qualified audio/video installer.
- Before installing the speakers, run the speaker cables to the installation location.

CAUTION

- When installing the speakers, do not touch the center of the drive unit with your hands or expose them to excessive physical shock. If they are dented, the sound will be distorted.
- Be aware of any concealed studs, electrical wiring or plumbing in the ceiling into which you are installing the speaker. If you are not sure of a safe way to install this speaker, consult a professional installer or a building contractor.
- When installing your NS-IC400 in-ceiling speakers, be aware of the product weight (See specification page) and the sturdiness of the material into which you are installing the speakers.
- Placing the speakers too close to a CRT-type TV may impair the picture color or cause a buzzing noise. In this case, move the speakers away from the TV. This is not an issue with LCD and plasma TVs.

NOTE

- If you wish to paint the speaker grille, refer to page 10 “**PAINTING THE SPEAKER GRILLE**” before proceeding.

Ceiling board thickness and clearance space above ceiling

- Check to ensure that the area you are installing the speaker is free of any ceiling joints or studs by tapping the ceiling or using a stud finder.
- Make sure that there is sufficient space on the ceiling for installation and that there are no obstructions such as ducts, pipes, etc. See the following chart for external product dimensions and ceiling installation measurements.
- The thickness required for the ceiling boards is 5 – 30 mm (1/4” – 1-1/8”).

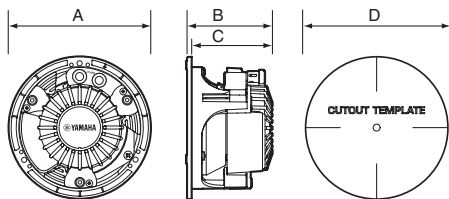

	NS-IC400
Diameter A	φ 139 mm (5-1/2")
Depth B	84 mm (3-3/8")
Depth C	79 mm (3-1/8")
Diameter D	φ 122 mm (4-3/4")

How to install

This is the recommended installation procedure when the material of the installation location is plasterboard.

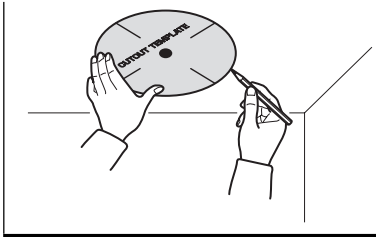

- 1** Position the cutout template where you are installing the speaker.
- 2** Trace a line around the template with a pencil. The mark for the center of the hole is also required.

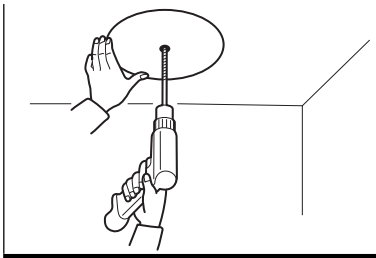

- 3** Drill the pilot hole at the center mark made on the ceiling.

WARNING

- When using a drill or cutting tool, use safety goggles for eye protection and be sure to observe all safety precautions.

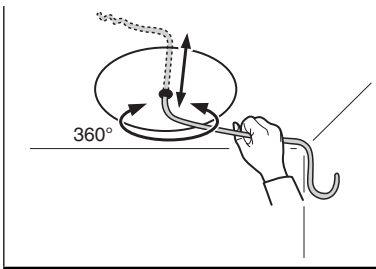

- 4** To check the space behind the hole, insert a bent sturdy wire (such as a coat hanger) into the hole, and then slowly rotate the wire to check for any obstruction.
 - If there is any obstruction, patch the hole and select another location.

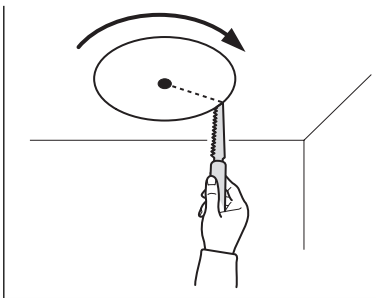

- 5** Insert the tip of a keyhole saw into the pilot hole, and then cut all of the way around the circular outline.

WARNING

- When using a keyhole saw or cutting tool, use safety goggles for eye protection and be sure to observe all safety precautions.

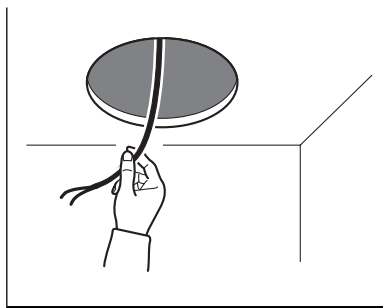

- 6** Pull the speaker cable out of the hole which you have cut.
- Leave some extra length of cable when pulling the cable out.

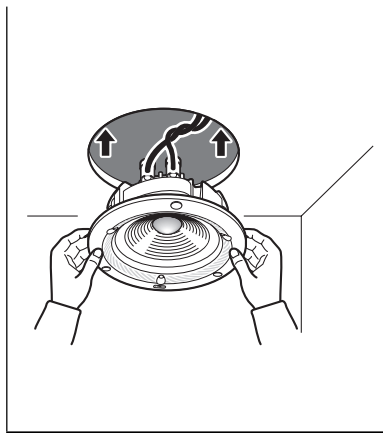

- 7** Connect the speaker cable to the speaker.
- For detailed instructions, refer to page 9 “**CONNECTING YOUR AMPLIFIER/RECEIVER**”.

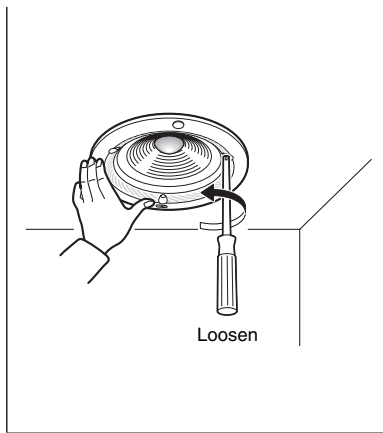

- 8** Place the speaker into the ceiling.
- CAUTION**
- When installing the speaker, do not touch the drive unit directly. This may cause a malfunction.
 - Make sure that mounting clamps are turned inward when installing the speaker in a ceiling.

- 9** Insert the speaker into the hole. Loosen three screws approximately one turn counter-clockwise. It will allow the clamps to open easily.

Evenly tighten each of the three mounting screws clockwise using a Philips screwdriver. (At this time, these three mounting clamps open in the ceiling. These opened clamps will press the ceiling board and the speaker together to secure the speaker.)

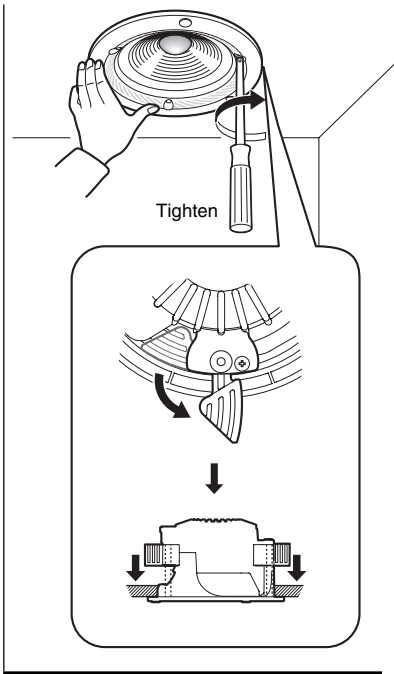

Tighten screws until the mounting clamps sufficiently grip the ceiling. Tighten the screws firmly to secure the speaker to the ceiling.

CAUTION

- When tightening the screws, do not screw too tightly. This may cause breakage of the mounting clamps and fracture of the wallboard.
- We recommend using only hand tools as power screwdrivers may over-tighten the screws. Should you use a power screwdriver be certain to select a very low torque setting to prevent damage to the speaker or to the wallboard.
- Make sure that none of the screws are loose and that there are no gaps between the speaker and the ceiling.

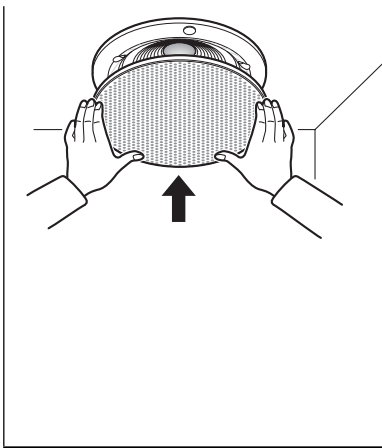

10 Attach the speaker grille to the speaker.

- As several magnets are on the speaker frame, attach the grille to the frame directly. When attaching the grille, make sure that the grille is attached to the speaker securely to keep the grille from falling.

CAUTION

- Be very careful when removing the grille, as it may fall or cause injury. Also, try to place an equal amount of pressure on the circumference when removing the grille. The grille may bend if too much pressure is placed in one location.

CONNECTING YOUR AMPLIFIER/RECEIVER

Before making connections, make sure that the amplifier/receiver is switched off.

- When connecting, also refer to the owner's manual of the connected equipment.

Connections

- Connect the push input terminals at the rear of the speakers to the speaker output terminals of the amplifier/receiver with the speaker cables (not included).
- Connect each speaker making sure not to reverse the polarity “+” (red), “-” (black). If the speaker is connected with reversed polarity, the sound will be unnatural and lack bass.

How to connect

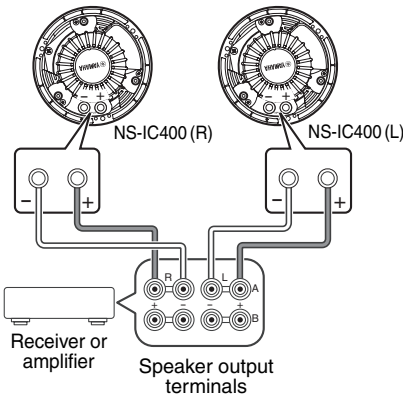
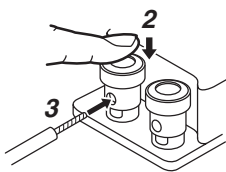
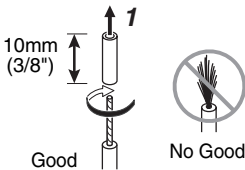

- 1** Remove approximately 10 mm (3/8”) of insulation from the end of each speaker cable using wire strippers, and then twist the exposed wires of the cable together to prevent short circuits.

- 2** Press and hold down the speaker terminal.

- 3** Insert the bare wire into the hole in the side of each terminal.

- 4** Release the terminal.

- Test the firmness of the connection by pulling lightly on the cable at the terminal.

CAUTION

- Do not let the bare speaker wires touch each other as this could damage the speaker or amplifier/receiver, or both.

After connecting

- Lower the power amplifier/receiver volume control before changing input sources. Never change input sources (for example, FM to CD) at high listening levels. Always turn the receiver/amplifier unit off when installing or removing any cables.
- Anytime you note distortion, reduce the volume control on your power amplifier/receiver to a lower setting. Never allow your power amplifier to be driven into “clipping”.

PAINTING THE SPEAKER GRILLE

The speaker grilles can be painted to match your room décor. Use high quality spray paint and select a well ventilated area before proceeding.

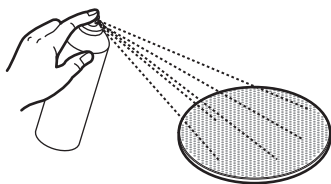

- 1** Carefully remove the grille from the speaker if attached.
- 2** Remove the scrim cloth that is attached to the back of the grille. (The adhesive that holds the cloth in place is reusable.)
- 3** Apply the paint to the grille.
 - Make sure that the grille holes remain free of paint.
 - Clogging the holes with paint may diminish the sound quality.
- 4** When the paint has fully dried, re-attach the scrim cloth to the back of the grille.
- 5** Re-install the grille on the speaker.

SPECIFICATIONS

		NS-IC400
Type		Full range open back type
Driver	Full range	10 cm (4") cone type
Frequency response		95 Hz to 40 kHz (-10dB)
Impedance		8 ohms
Nominal Input		30 W
Maximum input		90 W
Sensitivity		85 dB / 2.83 V, 1 m
Dimensions (with grille)		φ150 × 86.5D mm (φ5-7/8" × 3-3/8"D)
Weight (with grille)		0.8 kg (1.76 lbs)

- * Specifications subject to change without notice due to product improvements.
- * Speaker cables are not included with this model.

Limited Guarantee for European Economic Area (EEA) and Switzerland

Thank you for having chosen a Yamaha product. In the unlikely event that your Yamaha product needs guarantee service, please contact the dealer from whom it was purchased. If you experience any difficulty, please contact Yamaha representative office in your country. You can find full details on our website (<http://www.yamaha-hifi.com/> or <http://www.yamaha-uk.com/> for U.K. resident).

The product is guaranteed to be free from defects in workmanship or materials for a period of two years from the date of the original purchase. Yamaha undertakes, subject to the conditions listed below, to have the faulty product or any part(s) repaired, or replaced at Yamaha's discretion, without any charge for parts or labour. Yamaha reserves the right to replace a product with that of a similar kind and/or value and condition, where a model has been discontinued or is considered uneconomic to repair.

Conditions

1. The original invoice or sales receipt (showing date of purchase, product code and dealer's name) MUST accompany the defective product, along with a statement detailing the fault. In the absence of this clear proof of purchase, Yamaha reserves the right to refuse to provide free of charge service and the product may be returned at the customer's expense.
2. The product MUST have been purchased from an AUTHORISED Yamaha dealer within the European Economic Area (EEA) or Switzerland.
3. The product must not have been the subject of any modifications or alterations, unless authorised in writing by Yamaha.
4. The following are excluded from this guarantee:
 - a. Periodic maintenance and repair or replacement of parts due to normal wear and tear.
 - b. Damage resulting from:
 - (1) Repairs performed by the customer himself or by an unauthorised third party.
 - (2) Inadequate packaging or mishandling, when the product is in transit from the customer. Please note that it is the customer's responsibility to ensure the product is adequately packaged when returning the product for repair.
 - (3) Misuse, including but not limited to (a) failure to use the product for its normal purpose or in accordance with Yamaha's instructions on the proper use, maintenance and storage, and (b) installation or use of the product in a manner inconsistent with the technical or safety standards in force in the country where it is used.
 - (4) Accidents, lightning, water, fire, improper ventilation, battery leakage or any cause beyond Yamaha's control.
 - (5) Defects of the system into which this product is incorporated and/or incompatibility with third party products.
 - (6) Use of a product imported into the EEA and/or Switzerland, not by Yamaha, where that product does not conform to the technical or safety standards of the country of use and/or to the standard specification of a product sold by Yamaha in the EEA and/or Switzerland.
5. Where the guarantee differs between the country of purchase and the country of use of the product, the guarantee of the country of use shall apply.
6. Yamaha may not be held responsible for any losses or damages, whether direct, consequential or otherwise, save for the repair or replacement of the product.
7. Please backup any custom settings or data, as Yamaha may not be held responsible for any alteration or loss to such settings or data.
8. This guarantee does not affect the consumer's statutory rights under applicable national laws in force or the consumer's rights against the dealer arising from their sales/purchase contract.

Garantie Limitée pour l'Espace Économique Européenne et la Suisse

Merci d'avoir porté votre choix sur un produit Yamaha. Dans l'hypothèse où vous devriez recourir au service de notre garantie après-vente, veuillez contacter votre revendeur Yamaha. Si vous rencontrez la moindre difficulté, n'hésitez pas à contacter directement Yamaha dans votre pays de résidence. Vous pouvez trouver toutes informations complémentaires sur notre site Web (<http://www.yamaha-hifi.com/> ou <http://www.yamaha-uk.com/> pour les résidents au Royaume-Uni).

Yamaha garantit votre produit contre tout défaut de fabrication, pièces et main d'oeuvre, pour une durée de 2 ans à compter de la première date de vente au détail. Yamaha s'engage, dans les conditions décrites ci-après, à procéder à la réparation du produit défectueux (ou d'un quelconque de ses composants) ou à son remplacement à l'appréciation de Yamaha en prenant à sa charge les coûts relatifs aux pièces détachées et à la main d'oeuvre. Yamaha se réserve le droit de remplacer le produit par un modèle semblable, de par sa valeur et ses caractéristiques, dès lors que la commercialisation dudit produit a cessé ou bien lorsque sa réparation s'avère économiquement injustifiée.

Conditions

1. La facture d'achat originelle ou un justificatif d'achat correspondant (indiquant la date d'achat, la référence du produit et le nom du revendeur) DOIT accompagner le produit défectueux, ainsi qu'une description précise du dysfonctionnement constaté. En l'absence de cette preuve d'achat, Yamaha se réserve le droit de refuser le service de la garantie et le produit peut être restitué aux frais du consommateur.
2. Le produit DOIT avoir été acheté par un distributeur agréé Yamaha au sein de l'Espace Economique Européen ou en Suisse.
3. Le produit doit n'avoir fait l'objet d'aucune modification ou altération, sauf accord écrit de Yamaha.
4. Les cas suivants font obstacle à l'application de la garantie:
 - a. Entretien périodique et réparation ou remplacement de pièces ayant subi une usure ou défaillance normale.
 - b. Dommages résultant de:
 - (1) Réparation effectuée par le consommateur lui-même ou par un tiers non autorisé.
 - (2) Emballage ou manutention inadéquats lors du transport du produit pour réparation. Veuillez noter qu'il est de la responsabilité de l'expéditeur de s'assurer que le produit est correctement emballé.
 - (3) Utilisation non-conforme du produit, correspondant aux cas non limitatifs (a) d'utilisation non-conforme à l'objet normal du produit ou nonconforme aux instructions d'utilisation, de maintenance ou d'installation publiées par Yamaha, (b) ou d'utilisation du produit incompatible avec les normes techniques ou de sécurité en vigueur au sein du pays d'utilisation.
 - (4) Accidents, foudre, dégât des eaux, incendie, ventilation incorrecte, fuite de pile ou toute autre cause échappant au contrôle de Yamaha.
 - (5) Les défauts de la configuration dans laquelle ce produit est incorporé et/ou l'incompatibilité avec des produits tiers.
 - (6) Produit importé au sein de l'EEE, et/ou en Suisse, par une autre entité que Yamaha, dès lors que ce produit n'est pas conforme aux normes techniques ou de sécurité du pays d'utilisation et/ou aux normes des produits commercialisés par Yamaha au sein de l'EEE et/ou en Suisse.
5. Lorsque la garantie diffère entre le pays d'achat et le pays d'utilisation du produit, la garantie du pays d'utilisation est applicable.
6. Yamaha ne saurait être tenu pour responsable de quelconques pertes ou dommages, directs, consécutifs ou autres, sa responsabilité au titre de la garantie étant strictement limitée à la réparation ou au remplacement du produit.
7. Nous vous invitons à sauvegarder toutes les données ou réglages personnalisés de votre produit, Yamaha ne pouvant être tenu responsable de leur modification ou perte.
8. La présente garantie laisse intégralement subsister les droits que le consommateur peut détenir au titre de la garantie légale en vigueur ou au titre du contrat de vente conclu avec son revendeur.

Begrenzte Garantie für den Europäischen Wirtschaftsraum (EWR) und die Schweiz

Herzlichen Dank, dass Sie sich für ein Yamaha Produkt entschieden haben. In dem unwahrscheinlichen Fall, dass die Garantie für das Yamaha-Produkt in Anspruch genommen werden muss, wenden Sie sich bitte an den Händler, bei dem es gekauft wurde. Sollten Sie auf Schwierigkeiten stoßen, wenden Sie sich bitte an die Yamaha Repräsentanz in Ihrem Land. Auf unserer Internetseite (<http://www.yamaha-hifi.com/> oder <http://www.yamaha-uk.com/> für Einwohner Großbritanniens) finden Sie alle Einzelheiten.

Wir garantieren für einen Zeitraum von zwei Jahren ab ursprünglichem Kaufdatum, dass dieses Produkt frei von Verarbeitungs- oder Materialfehlern ist. Yamaha verpflichtet sich, gemäß der nachstehend angeführten Bedingungen, ein fehlerhaftes Produkt (oder Teile desselben) kostenfrei (gilt für Teile und Arbeit) zu reparieren oder auszutauschen. Diese Entscheidung obliegt ausschließlich Yamaha. Yamaha behält sich vor, das Produkt gegen ein in Art und/ oder Wert und Zustand ähnliches Produkt auszutauschen, wenn das entsprechende Modell nicht mehr erzeugt wird, oder die Reparatur als unrentabel angesehen wird.

Bedingungen

1. Dem defekten Produkt MUSS die Originalrechnung oder der Originalkaufbeleg (der Beleg muss das Kaufdatum, den Produkt-Code und den Namen des Händlers aufweisen) beigelegt werden, ebenso eine Fehlerbeschreibung. Bei Fehlen einer eindeutigen Kaufbestätigung behält sich Yamaha das Recht vor, den kostenfreien Service abzulehnen und das Produkt auf Kosten des Kunden zu retournieren.
2. Das Produkt MUSS von einem AUTORISIERTEN Yamaha-Händler innerhalb des Europäischen Wirtschaftsraums (EWR) oder der Schweiz gekauft worden sein.
3. Es wurden keine wie auch immer gearteten Änderungen am Produkt vorgenommen, außer diese wurden von Yamaha schriftlich genehmigt.
4. Folgendes ist von der Garantie ausgeschlossen:
 - a. Regelmäßige Wartung und Reparatur oder Austausch von Verschleißteilen.
 - b. Schaden durch:
 - (1) Vom Kunden selber oder von nichtbefugten Dritten ausgeführte Reparaturen.
 - (2) Unsachgemäße Verpackung oder Handhabung während des Transports vom Kunden. Beachten Sie bitte, dass die sachgerechte Verpackung des zur Reparatur gebrachten Produkts in der Verantwortung des Retournierenden liegt.
 - (3) Unsachgemäße Verwendung, einschließlich der, jedoch nicht beschränkt auf, (a) die Verwendung des Produkts zu anderen als den normalen Zwecken oder Behandlung entgegen die Anweisungen Yamahas zur korrekten Handhabung, Wartung oder Lagerung und (b) die Installierung oder Verwendung des Produkts auf andere Weise als dies den technischen oder Sicherheitsstandards jenes Landes entspricht, in dem das Produkt verwendet wird.
 - (4) Unfälle, Blitzschlag, Wasser, Feuer, ungeeignete Belüftung, Auslaufen der Batterie oder jedem anderen Grund, den Yamaha nicht beeinflussen kann.
 - (5) Defekte an jenem System, an welches dieses Produkt angeschlossen wird und/oder die Inkompatibilität mit Produkten anderer Hersteller.
 - (6) Die Verwendung eines nicht von Yamaha in den EWR und/oder die Schweiz importierten Produkts, wenn dieses Produkt nicht den technischen oder Sicherheitsstandards jenes Landes, in dem es verwendet wird, und/oder der standardisierten Produktspezifikation für von Yamaha im EWR und/oder der Schweiz vertriebene Produkte, entspricht.
5. Wenn es Unterschiede in den Garantiebedingungen zwischen jenem Land in dem das Produkt gekauft wurde, und jenem in dem das Produkt verwendet wird, finden die Garantiebedingungen jenes Landes Anwendung, in dem das Produkt verwendet wird.
6. Yamaha kann für keinerlei Verluste oder Schäden, ob direkt, in Konsequenz oder anderweitig, verantwortlich gemacht werden, außer bezüglich der Reparatur oder des Ersatzes eines Produkts.
7. Legen Sie bitte Kopien aller persönlichen Einstellungen und Daten an, da Yamaha weder für irgendwelche Änderungen noch für den Verlust solcher Daten verantwortlich gemacht werden kann.
8. Diese Garantie beeinflusst nicht die gesetzlichen Verbraucherrechte unter dem geltenden nationalen Recht oder die Verbraucherrechte gegenüber dem Händler, die durch einen Kaufvertrag entstehen.

Garanzia limitata per l'Area Economica Europea (AEE) e la Svizzera

Vi ringraziamo per aver scelto un prodotto Yamaha. Nel caso raro in cui il vostro prodotto abbia bisogno di riparazioni in garanzia, entrare in contatto con il negozio in cui era stato acquistato. Se si avessero difficoltà, entrare in contatto con il rappresentante di Yamaha per il proprio paese. Sono disponibili maggiori dettagli nel nostro sito (<http://www.yamaha-hifi.com/> o <http://www.yamaha-uk.com/>, per i residenti nel Regno Unito).

Il prodotto viene garantito esente da difetti di fabbricazione e di materiali per un periodo di due anni a partire dalla data di acquisto originale. Yamaha si impegna, entro i limiti delle condizioni illustrate di seguito, a riparare (o sostituire, a discrezione esclusiva di Yamaha) il prodotto difettoso o qualsiasi sua parte senza alcun addebito per le parti o per il lavoro. Yamaha si riserva il diritto di sostituire un prodotto con uno di tipo, valore e/o condizione simile nel caso un modello particolare non sia più in produzione o sia considerato troppo costoso da riparare.

Condizioni della garanzia

1. La fattura o ricevuta originale di pagamento (recante la data di acquisto, il numero di codice del prodotto e il nome del negozio di acquisto) DEVE accompagnare sempre il prodotto difettoso unita ad una dichiarazione descrittiva il problema accusato. In mancanza di prova esaustiva dell'avvenuto acquisto, Yamaha si riserva in diritto di rifiutare di fornire riparazioni gratuite ed il prodotto può venire restituito a spese dell'utente.
2. Il prodotto DEVE esser stato acquistato da un rivenditore Yamaha AUTORIZZATO all'interno dell'Area Economica Europea (EEA) o in Svizzera.
3. Il prodotto non deve esser modificato o alterato se non dietro autorizzazione scritta di Yamaha.
4. Quanto segue viene escluso dalla presente garanzia:
 - a. Manutenzione periodica e riparazioni o sostituzione di pezzi dovute a normale invecchiamento.
 - b. Danni risultato di:
 - (1) Riparazioni eseguite dal cliente stesso o da terze parti non autorizzate.
 - (2) Imballaggio o trattamento inadeguato nel corso della spedizione del prodotto da parte del cliente. Tener presente che, al momento dell'invio del prodotto per riparazioni, è responsabilità del cliente l'assicurarsi che questo sia imballato adeguatamente.
 - (3) L'uso scorretto, compresi ma senza limitazioni (a) il mancato uso del prodotto per il suo scopo previsto o in accordo con le istruzioni di Yamaha per l'uso corretto, la manutenzione e la conservazione e (b) l'installazione o uso del prodotto in modo non conforme agli standard tecnici e di sicurezza in vigore nel paese di uso.
 - (4) Gli incidenti, i fulmini, l'acqua, gli incendi, la ventilazione scorretta, la perdita di acido dalle batterie o qualsiasi altra causa non sotto il controllo di Yamaha.
 - (5) Difetti di un sistema nel quale il prodotto è stato incorporato e/o incompatibilità con prodotti di terze parti.
 - (6) L'uso di un prodotto importato nella EEA e/o in Svizzera, non prodotto da Yamaha, nel caso il prodotto non sia conforme agli standard tecnici o di sicurezza del paese di uso e/o alle caratteristiche tecniche standard dei prodotti Yamaha da vendersi nell'AEE e/o in Svizzera.
5. Dove i termini della garanzia differiscono fra il paese di acquisto e il paese di uso del prodotto, vale la garanzia del paese di uso.
6. Yamaha non può venire considerata responsabile di perdite o danni, diretti, indiretti, consequenziali o di altro tipo, se non in termini di riparazione o sostituzione del prodotto.
7. Fare una copia di riserva di impostazioni o dati personalizzati, dato che Yamaha non può venire considerata responsabile di qualsiasi alterazione o perdita di tali impostazioni o dati.
8. Questa garanzia non influenza i diritti statutari dell'utente stabiliti dalle leggi applicabili in vigore o i diritti sul negoziante derivanti dal contratto di vendita/acquisto.

Garantía limitada para el Área Económica Europea (AEE) y Suiza

Gracias por haber elegido un producto Yamaha. En el caso poco probable de que su producto Yamaha necesite el servicio que concede la garantía, póngase en contacto por favor con el concesionario a quien adquirió el producto. Si usted tiene alguna dificultad, póngase en contacto por favor con la oficina representativa de Yamaha en su país. Podrá encontrar todos los detalles necesarios en nuestros sitios Web (<http://www.yamaha-hifi.com/> o <http://www.yamaha-uk.com/> para los residentes del Reino Unido).

El producto tiene una garantía de dos años, a partir de la fecha de la compra original, que cubre las reparaciones de las averías que pueda tener debido a defectos en la mano de obra o en los materiales empleados en su fabricación. Yamaha se compromete, sujeto a las condiciones listadas más abajo, a reparar el producto o cualquier pieza (o piezas) que tenga defectos, o a sustituirlo, a discreción de Yamaha, sin cobrar ningún honorario por las piezas o la mano de obra. Yamaha se reserva el derecho de reemplazar un producto por otro de clase y/o precio y condiciones similares, en el caso de que éste no se fabrique más o se considere que las reparaciones resultan poco económicas.

Condiciones de la garantía

1. El producto defectuoso DEBERÁ ir acompañado de la factura o recibo de venta original (que muestre la fecha de la compra, el código del producto y el nombre del concesionario), junto con una explicación que describa detalladamente la avería. Si falta esta prueba clara de la compra, Yamaha se reserva el derecho a no proveer el servicio de reparaciones gratis, y el producto podrá ser devuelto al cliente corriendo éste con todos los gastos relacionados con el envío.
2. El producto DEBERÁ haber sido adquirido en el establecimiento de un concesionario Yamaha AUTORIZADO dentro del Área Económica Europea (AEE) o Suiza.
3. El producto no deberá haber sido sometido a ninguna modificación ni alteración, a menos que ésta haya sido autorizada por escrito por Yamaha.
4. De esta garantía se excluye lo siguiente:
 - a. El mantenimiento periódico y la reparación o sustitución de piezas debidos al desgaste natural.
 - b. Los daños debidos a:
 - (1) Reparaciones realizadas por el propio cliente o por un tercero que no cuente con ninguna autorización.
 - (2) Embalaje inadecuado o maltrato, cuando el producto está siendo transportado desde el lugar de residencia del cliente. Tenga en cuenta que el cliente es el responsable de embalar el producto adecuadamente cuando éste es devuelto para ser reparado.
 - (3) Mal uso, incluyendo, pero sin limitarse a: (a) no usar el producto de forma normal o no seguir las instrucciones de uso, mantenimiento y almacenamiento apropiadas indicadas por Yamaha, y (b) instalación o uso del producto de forma inconsistente con las normas técnicas o de seguridad vigentes en el país donde éste se utiliza.
 - (4) Accidentes, rayos, agua, fuego, ventilación inadecuada, fuga de pilas o cualquier otra causa fuera del control de Yamaha.
 - (5) Defectos del sistema en el que se incorpora este producto e/o incompatibilidad con productos de terceros.
 - (6) Uso de un producto importado en la EEA y/o Suiza, no por Yamaha, donde ese producto no cumple con las normas técnicas o de seguridad del país donde se usa y/o con la especificación estándar de un producto vendido por Yamaha en la EEA y/o en Suiza.
5. Cuando las garantías del país donde se compra el producto y del país donde éste se usa son diferentes se aplicará la garantía del país donde se usa el producto.
6. Yamaha no se hará responsable de ninguna pérdida o daño directo, emergente o de cualquier otro tipo; sólo se hará responsable de la reparación o sustitución del producto.
7. Haga una copia de seguridad de cualquier configuración o datos personalizados, ya que Yamaha no se hará responsable de ninguna alteración o pérdida que tal configuración o datos puedan sufrir.
8. Esta garantía no afecta a los derechos legales del consumidor bajo las leyes nacionales aplicables vigentes, ni a los derechos del consumidor contra el concesionario surgidos de su contrato de venta/compra.



YAMAHA CORPORATION

Printed in Indonesia  WV73970