



DVD/VIDEO CD/CD PLAYER
LECTEUR DE DVD

DVD-S520

OWNER'S MANUAL
MODE D'EMPLOI



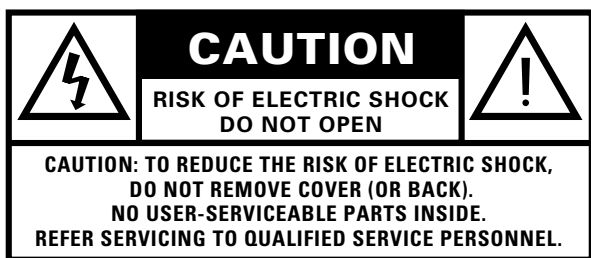

This symbol warns the user that uninsulated voltage within the unit may have sufficient magnitude to cause electric shock. Therefore, it is dangerous to make any kind of contact with any inside part of this unit.



This symbol alerts the user that important literature concerning the operation and maintenance of this unit has been included. Therefore, it should be read carefully in order to avoid any problems.

WARNING

To reduce the risk of fire or electric shock, do not expose this appliance to rain or moisture.

CAUTION

Use of controls or adjustments or performance of procedures other than herein may result in hazardous radiation exposure.

The set complies with the FCC-Rules, Part 15 and with 21 CFR 1040.10.

IMPORTANT SAFETY INSTRUCTIONS

1. **Read these instructions.**
2. **Keep these instructions.**
3. **Heed all warnings.**
4. **Follow all instructions.**
5. **Do not use this apparatus near water.**
6. **Clean only with a dry cloth.**
7. **Do not block any of the ventilation openings. Install in accordance with the manufacturers instructions.**
8. **Do not install near any heat sources** such as radiators, heat registers, stoves, or other apparatus (including amplifiers) that produce heat.
9. **Do not defeat the safety purpose** of the polarized or grounding-type plug. A polarized plug has two blades with one wider than the other. A grounding type plug has two blades and a third grounding prong. The wide blade or the third prong are provided for your safety. When the provided plug does not fit into your outlet, consult an electrician for replacement of the obsolete outlet.
10. **Protect the power cord** from being walked on or pinched, particularly at plugs, convenience receptacles, and the point where they exit from the apparatus.

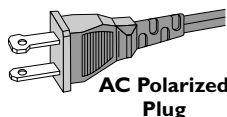

AC Polarized Plug

11. **Only use attachments/accessories** specified by the manufacturer.
12.  **Use only with a cart,** stand, tripod, bracket, or table specified by the manufacturer or sold with the apparatus. When a cart is used, use caution when moving the cart/apparatus combination to avoid injury from tip-over.
13. **Unplug this apparatus** during lightning storms or when unused for long periods of time.
14. **Refer all servicing** to qualified service personnel. Servicing is required when the apparatus has been damaged in any way, such as if the power-supply cord or plug is damaged, liquid has been spilled or objects have fallen into the apparatus, or when the apparatus has been exposed to rain or moisture, does not operate normally, or has been dropped.
15. **Battery usage CAUTION** – To prevent battery leakage which may result in bodily injury or damage to the unit:
 - Install **all** batteries correctly, **+** and **-** as marked on the unit.
 - Do not mix batteries (**old** and **new** or **carbon** and **alkaline**, etc.).
 - Remove batteries when the unit is not used for a long time.

EL 6475-E002: 01/3

FCC INFORMATION (for US customers only)

1. IMPORTANT NOTICE: DO NOT MODIFY THIS UNIT!

This product, when installed as indicated in the instructions contained in this manual, meets FCC requirements. Modifications not expressly approved by Yamaha may void your authority, granted by the FCC, to use the product.

2. IMPORTANT: When connecting this product to accessories and/or another product use only high quality shielded cables. Cable/s supplied with this product MUST be used. Follow all installation instructions. Failure to follow instructions could void your FCC authorization to use this product in the USA.

3. NOTE: This product has been tested and found to comply with the requirements listed in FCC Regulations, Part 15 for Class "B" digital devices. Compliance with these requirements provides a reasonable level of assurance that your use of this product in a residential environment will not result in harmful interference with other electronic devices. This equipment generates/uses radio frequencies and, if not installed and used according to the instructions found in the users manual, may cause interference harmful to the operation of other electronic devices. Compliance with FCC regulations does not guarantee that interference will not occur in all installations. If this product is found to be the source of interference, which can be determined by turning the product "OFF" and "ON", please try to eliminate the problem by using one of the following measures: Relocate either this product or the device that is being affected by the interference.

Utilize power outlets that are on different branch (circuit breaker or fuse) circuits or install AC line filter/s.

In the case of radio or TV interference, relocate/reorient the antenna. If the antenna lead-in is 300 ohm ribbon lead, change the lead-in to coaxial type cable.

If these corrective measures do not produce satisfactory results, please contact the local retailer authorized to distribute this type of product. If you can not locate the appropriate retailer, please contact Yamaha Electronics Corp., 6600 Orangethorpe Ave. Buena Park, CA90622.

The above statements apply ONLY to those products distributed by Yamaha Corporation of America or its subsidiaries.

We Want You Listening For A Lifetime

YAMAHA and the Electronic Industries Association's Consumer Electronics Group want you to get the most out of your equipment by playing it at a safe level. One that lets the sound come through loud and clear without annoying blaring or distortion - and, most importantly, without affecting your sensitive hearing.

Since hearing damage from loud sounds is often undetectable until it is too late, YAMAHA and the Electronic Industries Association's Consumer Electronics Group recommend you to avoid prolonged exposure from excessive volume levels.



For Customer Use:

Read carefully the information located at the rear panel of the player and enter below the Serial No. Retain this information for future reference.

Model No. _____

Serial No. _____

FOR CANADIAN CUSTOMERS

To prevent electric shock, match wide blade of plug to wide slot and fully insert.

This Class B digital apparatus complies with Canadian ICES-003.

This digital apparatus does not exceed the Class B limits for radio noise emissions from digital apparatus as set out in the Radio Interference Regulations of the Canadian Department of Communications.

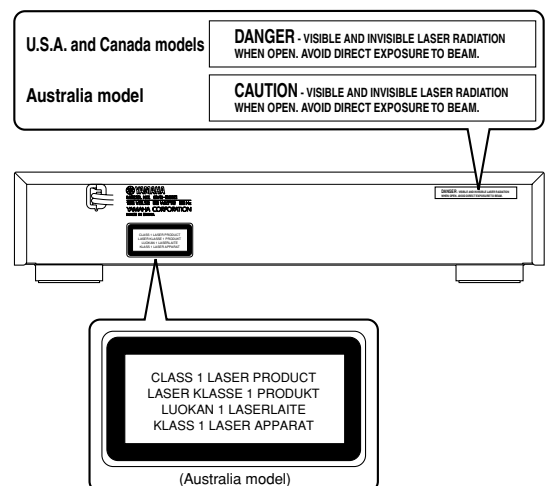

CAUTION: READ THIS BEFORE OPERATING YOUR UNIT.

- 1 To assure the finest performance, please read this manual carefully. Keep it in a safe place for future reference.
- 2 Install this unit in a well ventilated, cool, dry, and clean place with at least 2.5 cm (1 inch) above, behind and on the both sides of this unit - away from direct sunlight, heat sources, vibration, dust, moisture, and/or cold.
- 3 Position this unit away from other electrical appliances, motors and transformers to avoid humming sounds, do not place this unit where it may get exposed to rain or any kind of liquid to prevent fire or electrical shock.
- 4 Avoid extreme temperature swings or excessive use of humidifier in the room where this unit is installed to prevent condensation inside this unit, which may cause an electrical shock, fire, damage to this unit, and/or personal injury.
- 5 Do not cover this unit with a newspaper, a tablecloth, a curtain, etc. in order not to obstruct heat radiation. If the temperature inside this unit rises, it may cause fire, damage to this unit and/or personal injury.
- 6 Avoid installing is unit in a place where foreign objects and liquid might fall. It might cause a fire, damage to this unit and/or personal injury. Do not place the following objects on this unit:
 - Other components, as they may cause damage and/or discoloration on the surface of this unit.
 - Burning objects (i.e., candles), as they may cause fire, damage to this unit and/or personal injury.
 - Containers with liquid in them, as they may cause an electrical shock to the user and/or damage to this unit.
- 7 Do not operate this unit upside-down. It may overheat, possibly causing damage.
- 8 Do not use force on switches, controls or connection cables. Never pull the cables when disconnecting them.
- 9 Only voltage specified on this unit must be used. Using this unit with a higher voltage than specified is dangerous and may result in fire or other accidents. YAMAHA will not be held responsible for any damage resulting from the use of this unit with a voltage other than that specified.
- 10 Do not attempt to clean this unit with chemical solvents; this might damage the finish. Use a clean, dry cloth.
- 11 Disconnect the power cord from the wall outlet when not planning to use this unit for a long period of time, or during an electrical storm, as they may cause damage by lightning.
- 12 Do not attempt to modify or fix this unit. Contact the qualified YAMAHA service personnel when any service is needed. Cabinet should never be opened for any reasons.
- 13 Be sure to read 'TROUBLESHOOTING' section regarding common operating errors before concluding that this unit is faulty.

NOTE:

Pictures shown maybe different between countries.

Never make or change connections with the power switched on.

When playing DTS encoded CDs, excessive noise will be heard from the analog stereo outputs. To avoid possible damage to the audio system, the consumer should take proper precautions when the analog stereo outputs of the player are connected to an amplification system. To enjoy DTS Digital Surround™ playback, an external 5.1-channel DTS Digital Surround™ decoder system must be connected to the digital output of the player.

LASER SAFETY

This unit employs a laser. Due to possible eye injury, only a qualified service person should remove the cover or attempt to service this device.

Use of controls or adjustments or performance of procedures other than those specified herein may result in hazardous radiation exposure.

CAUTION

VISIBLE AND INVISIBLE LASER RADIATION WHEN OPEN. AVOID EXPOSURE TO BEAM (WARNING LOCATION: INSIDE ON LASER COVERSIELD OR THE BACKPLATE OF SET)

LASER

Type	Semiconductor laser GaAlAs
Wave length	650 nm (DVD) 780 nm (VCD/CD)
Output Power	7 mW (DVD) 10 mW (VCD/CD)
Beam divergence	60 degree

Contents

TruSurround and the SRS symbol are trademarks of SRS Labs., Inc. TruSurround technology is incorporated under license from SRS Labs., Inc.



Manufactured under license from Dolby Laboratories. "Dolby" and the double-D symbol are trademarks of Dolby Laboratories.

"DTS" and "DTS Digital Surround" are trademarks of Digital Theater Systems, Inc.

This product incorporates copyright protection technology that is protected by method claims of certain U.S. patents and other intellectual property rights owned by Macrovision Corporation and other rights owners. Use of this copyright protection technology must be authorized by Macrovision Corporation, and is intended for home and other limited viewing uses only unless otherwise authorized by Macrovision Corporation. Reverse engineering or disassembly is prohibited.

Introduction	2
DVD Video Introduction	2
Unpacking	2
Remote Control Battery Installation	2
Environmental Information	2
Cleaning Discs	2
Functional Overview	3
Front and Rear Panels	3
Remote Control	4
Preparation	5
General Notes	5
Digital Connections	5
Analog Connections	5
Video Connections	5
NTSC/PAL Settings	6
NTSC/PAL Conversion	6
General Explanation	7
Menu Bar/Status Window	7
Temporary Feedback Field Icons	7
Personal Preferences	8
Operation	10
Loading Discs	10
Playing a DVD Video and Video CD	10
General Features	10
Special DVD Features	12
Special Video CD & SVCD Features	13
Playing an Audio CD	13
Favorite Track Selection (FTS) Program	13
MP3 Disc Features	14
Access Control	15
Deciding the PIN number	15
Access Control: Child Lock (DVD Video and Video CD)	15
Access Control: Parental Control (DVD Video only)	15
Before Requesting Service	17
Specifications	18

Introduction

DVD Video Introduction

The player will play digital video discs conforming to the universal DVD Video standard. The unique features on DVD Video, such as selection of sound track, subtitle languages and different camera angles (again depending on the disc), are all supported.

In addition to DVD Video discs, you will be able to play all Video CDs and Audio CDs.

DVD Video

You will recognize DVD Video discs by the logo shown. Depending on the material on the disc (a movie, video clips, a drama series, etc.) the disc may have one or more Titles.

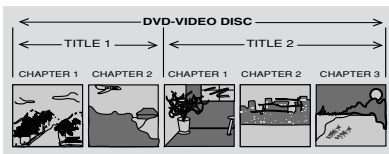

The region code is **1** for U.S.A and Canada models, **4** for the Australia model



Since it is usual for DVD movies to be released at different times in different regions of the world, all players have region codes and discs can have an optional region code. If you load a disc of a different region code to the player, you will see the region code notice on the screen. The disc will not play and should be unloaded.

Video CD

You will recognize Video CDs by the logo shown.



SuperVideo CD (SVCD)

SVCDs are based on the SuperVCD IO Standard, referring to the Standard of Electronics Industry of the People's Republic of China.

Audio CD

Audio CDs contain music tracks only. You will recognize Audio CDs by the logo shown.



MP3 (MPEG Audio Layer 3)

The player supports the MP3 format which contains compressed music tracks.

Notes:

- CD-R and CD-RW cannot be played unless finalized.
- Some discs cannot be played depending on the disc characteristics or recording conditions.

Unpacking

First check and identify the contents of the player package. You should have the following items.

- The player
- Remote Control with batteries
- Audio cable
- Video cable
- Owner's Manual

If any item is damaged or missing, contact your retailer. Keep the packaging material for future transportation.

Remote Control Battery Installation

- Insert batteries as indicated inside the battery compartment.

Caution: Do not mix old and new batteries. Never mix different types of batteries (standard, alkaline, etc.).

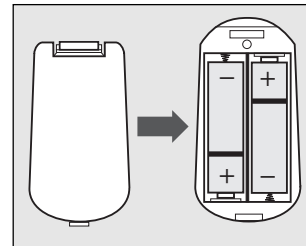

Environmental Information

- Your system consists of materials which can be recycled and reused if disassembled by a specialized company. Please observe the local regulations regarding the disposal of packaging materials, exhausted batteries and old equipment.

Cleaning Discs

- When a disc becomes dirty, clean it with a cleaning cloth. Wipe the disc from the center out, in a straight line.
- Do not use solvents such as benzine, thinner, commercially available cleaners, or anti-static spray intended for analog discs.

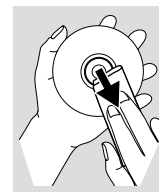

Functional Overview

Front and Rear Panels

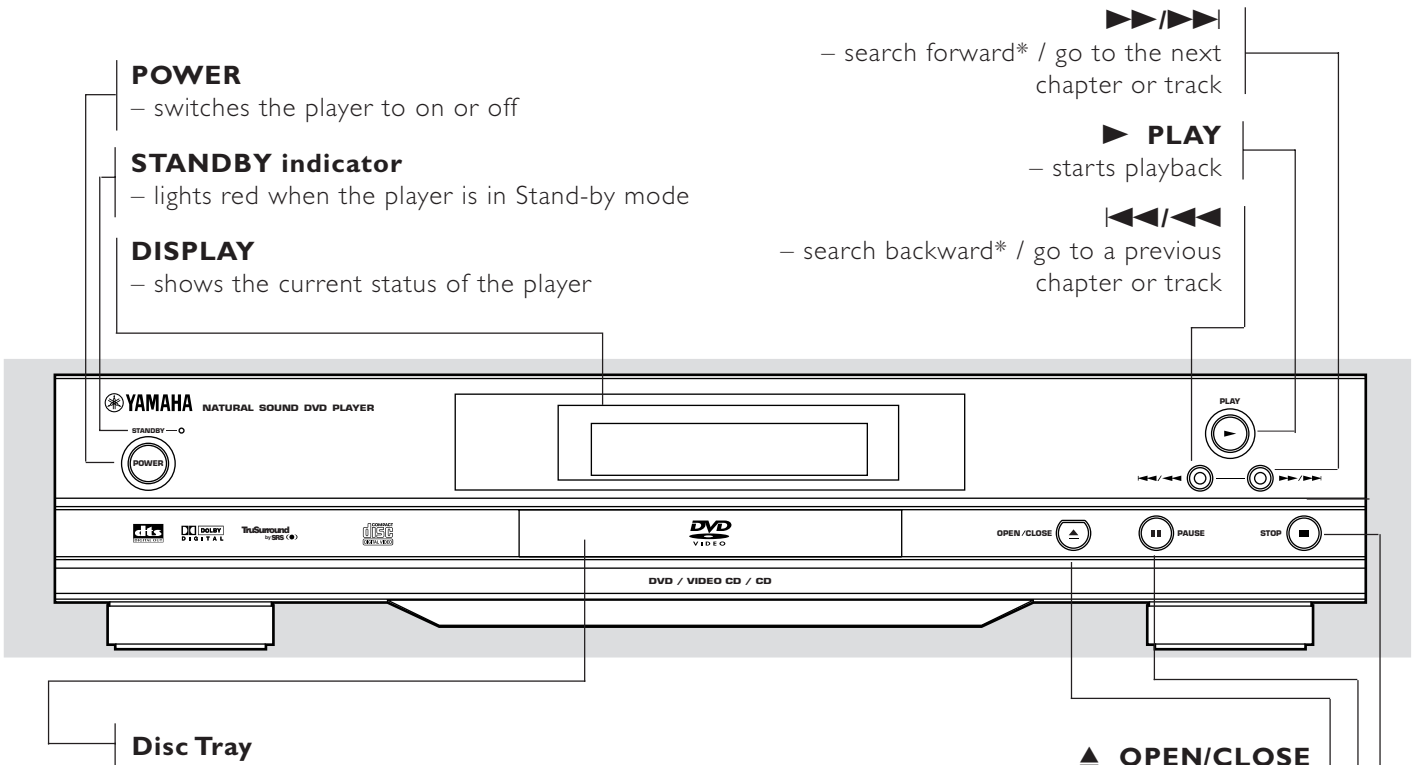

* Press and hold button for about two seconds

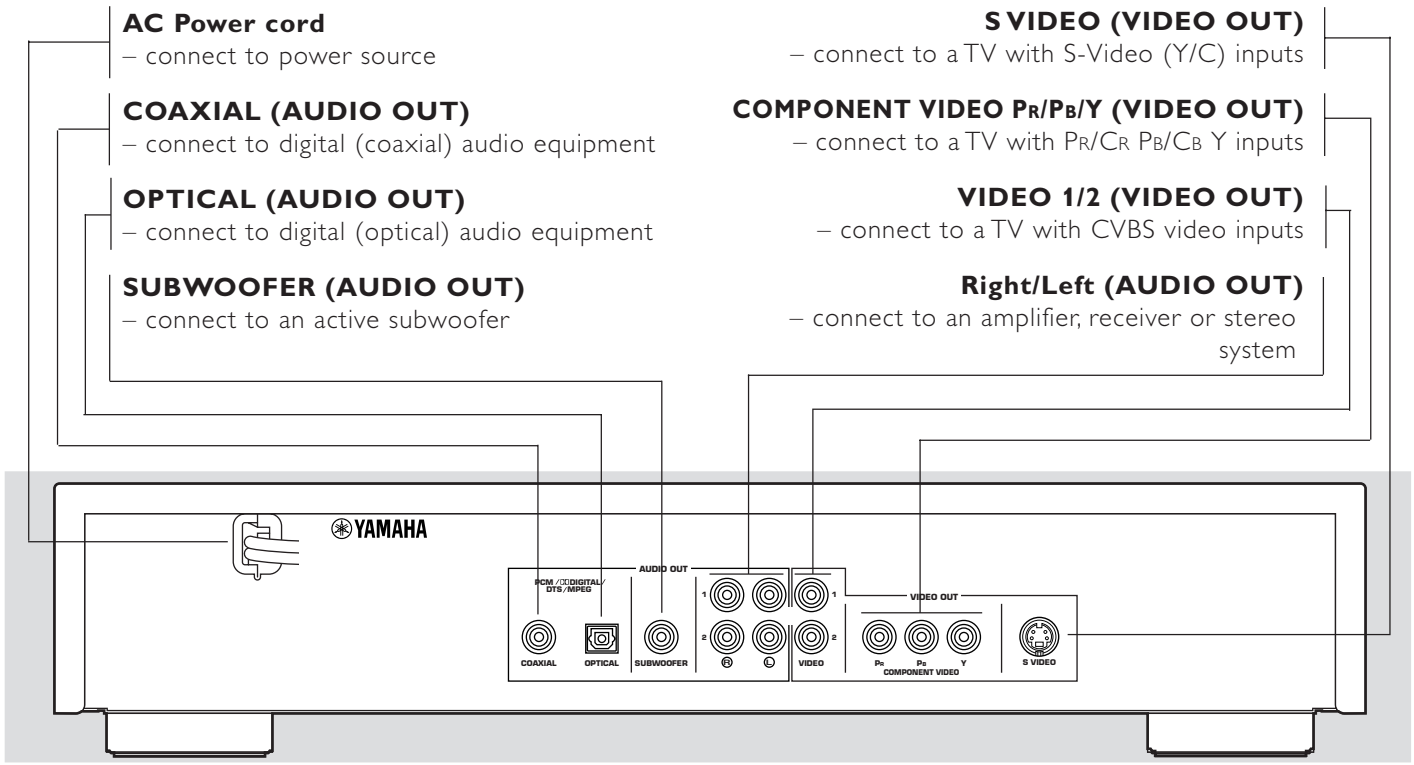

Caution: Do not touch the inner pins of the jacks on the rear panel. Electrostatic discharge may cause permanent damage to the unit.

Remote Control

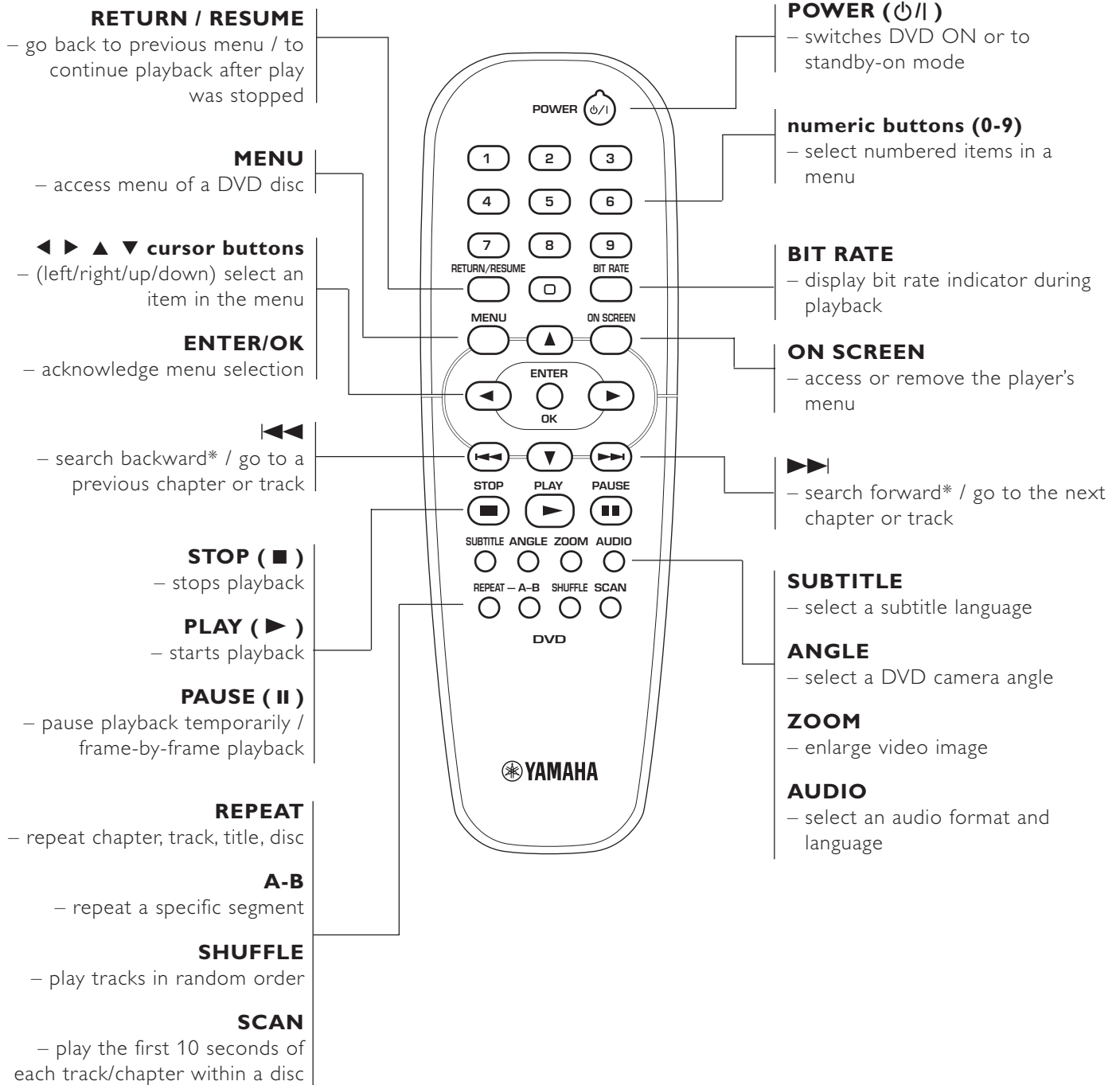

* Press and hold button for about two seconds

Preparation

General Notes

- Depending on the equipment you wish to connect, there are various ways you could connect the player. Possible connections are shown in the following drawings.
- Please refer to the manuals of other equipment as necessary to make the best connections.
- Do not connect the player via your VCR. The video quality could be distorted by the copy protection system.
- Do not connect the player's audio out jack to the phono in jack of your audio system.

Digital Connections

The player has COAXIAL and OPTICAL digital out jacks. Connect one or both of them to your AV receiver equipped with Dolby digital, DTS, or MPEG decoder using each specific cable (separate purchase).

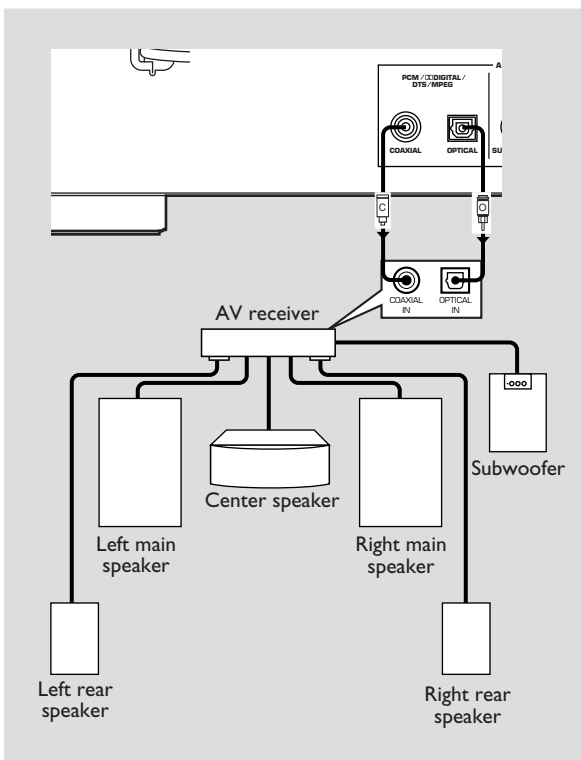

You will need to activate the player's digital output (see 'Personal Preferences').

Note:

– If the audio format of the digital output does not match the capabilities of your receiver, the receiver will produce a strong, distorted sound or no sound at all. Make sure to select the appropriate audio format at menu screen included on the disc. Pressing AUDIO once or more may change not only audio languages but also audio formats, and the selected format appears for several seconds on the status window.

Analog Connections

Use RCA audio cable supplied with the player to connect AUDIO OUT L (left) and R (right) jacks of the player to corresponding input jacks of your audio equipment such as Stereo amplifier. You can connect a subwoofer to the player's SUBWOOFER (AUDIO OUT) jack.

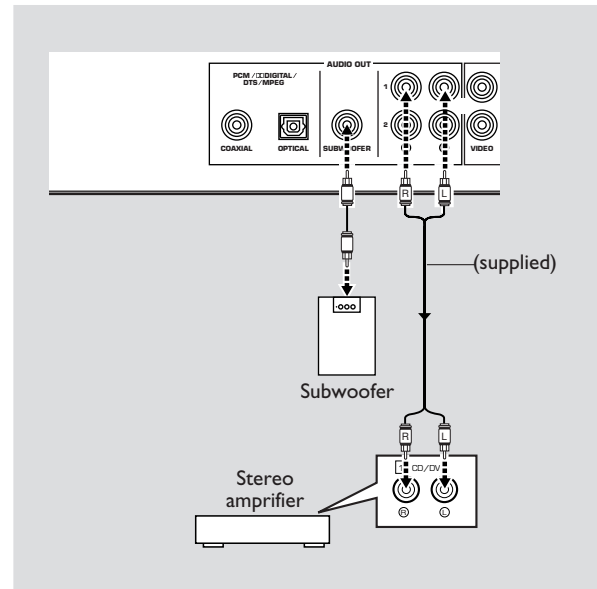

Video Connections

If your AV receiver has video output jacks, connect your receiver (and then to your TV) so that you can use one TV for several different video sources (LD, VCR etc.) by simply switching the input source selector of your receiver. The player has three types of video output jacks. Use one of them in accordance with the input jacks of the equipment to be connected.

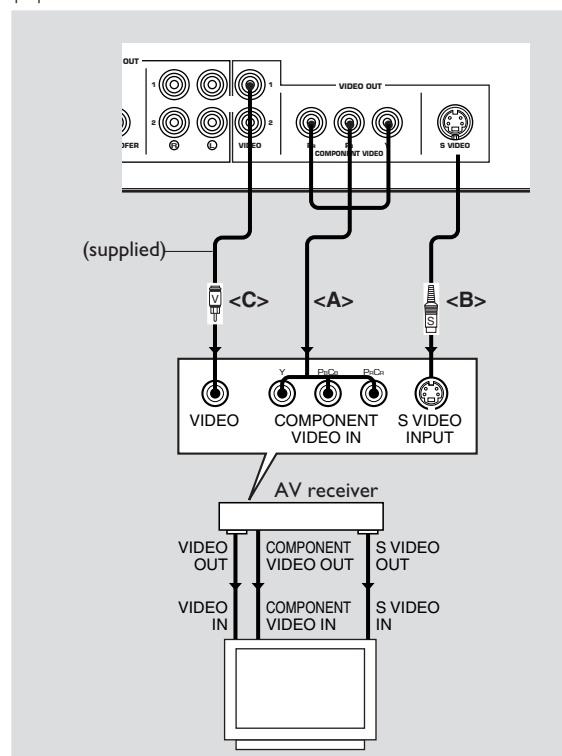

Component Video terminal <A>

Component video connection achieves high fidelity in reproducing colors (better performance than S-video connection), separating video signal into luminance (Y, terminal color-coded as green), and color difference (Pb, blue/Pr, red). Use commercially available coaxial cables. Receiver (and TV) with component input is required. Observe the color of each jack when connecting. If your receiver does not have component output jacks, connecting the player's component output directly to your TV's component input can reproduce better video image.

Note:

– Do not connect the player's COMPONENT VIDEO OUT jacks to component video input jacks special for HD (High-Definition) TV.

S-Video terminal

S (separate) video connection achieves a clearer picture than composite video connection by separating color and luminance when transmitting signals. Use commercially available S-video cable. Receiver (and TV) with S-video input is required.

Composite Video terminal (1, 2) <C>

Use RCA video cable supplied with the player when connecting the player to a TV. VIDEO 1, 2 jacks of VIDEO OUT output the same signal. You can connect one to your receiver's input using supplied RCA cable, and the other to another receiver or a TV.

NTSC/PAL Settings

You can switch the NTSC/PAL setting of the player to match the video signal of your TV. This setting only affects the television's on-screen display that shows the stop and setup modes. You may select either NTSC or PAL. To change the player setting to PAL or NTSC, follow the steps below.

- 1 Press the POWER button on the front panel of the player to turn off the player.
- 2 Press and hold ■ and ►►I on the front of the player. While holding ■ and ►►I, press POWER.
- 3 After PAL or NTSC appears on the player display, release ■ and ►►I at the same time. The PAL or NTSC indicator that appears on the player display indicates the current setting.
- 4 To change the setting, press ►►I within three seconds. The new setting (PAL or NTSC) will appear on the player display.

NTSC/PAL Conversion

The player is equipped with a NTSC/PAL conversion feature to convert the video output of the disc to match your TV system. The conversions supported are as below:

Type	Disc Format	Output format Selected mode		
		NTSC	PAL	AUTO
DVD	NTSC	NTSC	PAL60	NTSC
	PAL	Not Supported	PAL	PAL
VCD	NTSC	NTSC	PAL60	NTSC
	PAL	NTSC	PAL	PAL

Select among NTSC, PAL and AUTO. See 'Personal Preferences' for operational procedure.

Notes:

- AUTO can only be selected when using a TV that has both the NTSC and PAL systems.
- Slight picture distortions may occur due to this conversion. This is normal. Thus, the AUTO format is most suitable for the best picture quality.

General Explanation

About this manual

This manual gives the basic instructions for operating the player. Some DVDs require specific operation or allow only limited operation during playback. When this occurs, the symbol  appears on the screen, indicating that the operation is not permitted by the player or the disc.

Remote control operation

- Unless stated, all operations can be performed by the remote control. Always point the remote control directly at the player, making sure there are no obstructions between the remote and the player. Corresponding buttons on the front panel of the player can also be used.





Menu bar operation

- A number of operations can be done with the menu bar on the screen. The menu bar can be accessed by pressing the cursor buttons on the remote control.
- Pressing ON SCREEN while the menu bar is displayed will clear the menu bar from the screen.
- The selected item will be highlighted, and the appropriate cursor buttons to operate it will be displayed below the icon.
- The symbols < or > indicate more items are available at the left/right of the menu bar. Press ◀ or ▶ to select these items.



Menu Bar/Status Window

As there are multiple menu bars, the items on the menu bar are arranged according to usage and availability of direct access buttons. Pressing the ON SCREEN buttons repeatedly will toggle through menu bar 1, menu bar 2, menu bar 3 and OFF.





Menu bar 1

-  User Preference Settings
-  Current Subtitle Language
-  Current Audio Language
-  Smart Color
-  Sound mode















Menu bar 2

-  Frame by Frame
-  Slow Motion
-  Scan Speeds
-  Camera Angle
-  Enlarge Picture

Menu bar 3

-  Title
-  Chapter
-  Time Search
-  Favorite Track Selection

Temporary Feedback Field Icons

-  scan Scan
-  repeat Repeat All
-  title Repeat Title
-  track Repeat Track
-  chapter Repeat Chapter
-  shuffle Shuffle
-  shuffle Shuffle Repeat
-  A- Repeat A to end
-  A-B Repeat A-B
-  Angle
-  locked Child Lock On
-  safe Child Safe
-  resume Resume
-  Action prohibited

Personal Preferences

You can set your own personal preferences on the player.

General operation:

- Press ON SCREEN on the remote control.
- Select **TA** in the menu bar and press **▼**.
→ The Personal Preferences menu appears.
- Use the **◀ ▶ ▲ ▼** buttons to toggle through the menus, submenus and submenu options.
→ When a menu item is selected, the cursor buttons (on the remote control) to operate the item are displayed next to the item.
- Press ENTER/OK to confirm and return to the main menu. The following items can be adapted:

Picture

– TV Shape

If you have a wide screen (16:9) TV, select 16:9.
If you have a regular (4:3) TV, select 4:3.
If you have a 4:3 TV, you can also select between: Letterbox for a 'wide-screen' picture with black bars at the top and bottom of the screen, or Pan Scan, for a full-height picture with the sides trimmed. If a disc supports the format, the picture will be shown accordingly.

– Black level shift (NTSC users only)

Select ON for adapting the color dynamics to obtain richer contrasts.

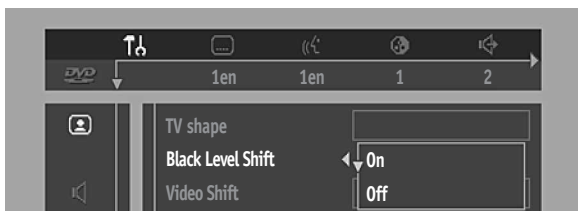

– Video shift

The factory centers the video on the screen. Use this setting to personalize the position of the picture on the screen by moving it to the left or right.

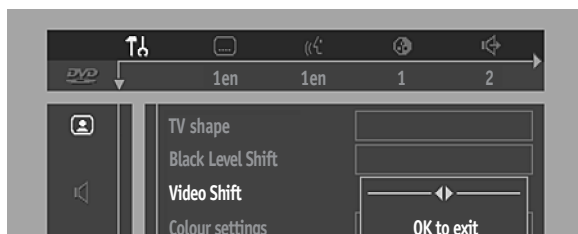

– Color settings

You can select one of five predefined sets of color settings and one set (Personal) which you can define yourself.

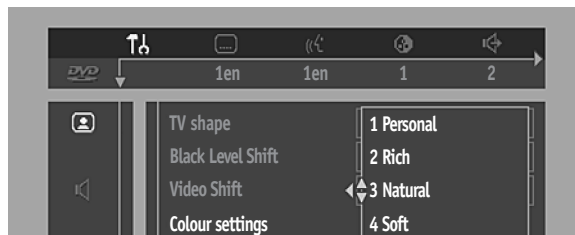

– Personal color

Allows you to fine-tune the selected color settings saturation, brightness and contrast.

– TV System

Usually you don't have to change the default setting, See 'NTSC/PAL Conversion' for detailed information.

Sound

– Digital output

Factory setting: ALL. This means coaxial and optical outputs are on. If you are not connecting to equipment with a digital input, change the setting to OFF.

If your equipment doesn't include a digital multi-channel decoder, set the digital output to PCM only (Pulse Code Modulation).

Note:

– When the setting is ALL, make sure that the selected audio format of the disc you play matches the connected equipment's capability. If a digital signal which the equipment cannot handle is output, there may be a noise and that could damage your ears and your speakers.

– When CDs were put on the market in the early stage, high tones from some of them would be heard as punch lacked.

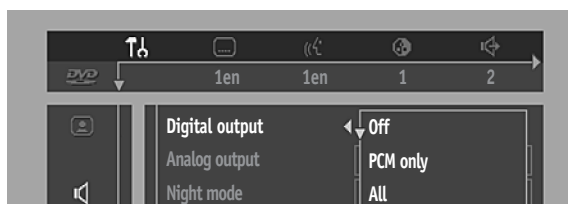

– Analog output

Select Stereo, Dolby Surround or 3D Sound (TruSurround) to match your system's playback capability.

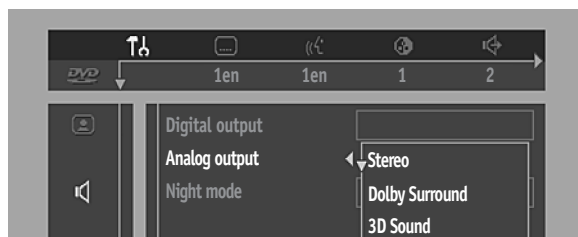

– Night Mode

Optimizes the dynamics of the sound for low volume playback.

– Karaoke vocal

Put this setting to ON only when a multi-channel karaoke DVD is being played. The karaoke channels on the disc will then be mixed into a normal stereo sound.

– Subwoofer cut-off

The frequency of the subwoofer output can be set to HIGH (200Hz) or LOW (100Hz) to match your system's playback sound quality.

– PCM Output

Allows to select PCM digital output between 48kHz and 96kHz. Some 96kHz DVD discs are copyright protected. If your selection is 96kHz, the digital output is muted to comply the standards. Please select 48kHz to enable the output.

Language

Select the required Menu, Audio and Subtitle language. Audio language and Subtitle language can also be adapted using the Menu bar.

Features

– Access Control

Access Control contains the following features:
 Child Lock - When Child Lock is set to ON, a 4-digit code must be entered in order to play discs.
 Parental control - Allows the conditional viewing of DVDs containing Parental Control information.

– Status Window

Displays the current status of the player and appears with the menu bar. When disc playback is stopped, it is displayed with the 'Temporary Feedback Field' in the default screen. The factory setting is ON. Select OFF to suppress display of the Status Window.



– Low Power Standby

This setting is effective for Europe and U.K. models, when the DVD player is connected between your TV and VCR with SCART cables. If you use TV and VCR while the DVD player is turned off, set Low Power Standby to OFF. Otherwise VCR does not function.

– PBC

Some Video CDs have PBC(Playback control). When activated, a menu screen included on the disc appears soon after playback starts.

– Help text

When set to ON, help text describes the icons selected. Select OFF if you no longer require the help text.

Operation

Loading Discs

- 1 Press OPEN/CLOSE on the front of the player to open the disc tray.
- 2 Load your chosen disc in the tray, label side up.
- 3 Press OPEN/CLOSE again to close the tray.
→ **reading** appears in the status window and **READING** on the player display, and playback starts automatically.

Note:

– If 'Child Lock' is set to ON and the disc inserted is not authorized, the 4-digit code must be entered and/or the disc must be authorized (see 'Access Control').

Playing a DVD Video and Video CD

Playing a disc

- After inserting the disc and closing the tray, playback starts automatically. The status window of the player display shows the type of disc loaded, as well as the disc's information and playing time.
- The disc may invite you to select an item from a menu. If the selections are numbered, press the appropriate numeric button; if not, use the ▼▲◀▶ buttons to highlight your selection, then press ENTER/OK.
- The number of the current title and chapter are displayed on the player display.
- Playback may stop at the end of the Title and you may return to the DVD disc menu.
- To stop playback, press ■.
→ The default screen will appear, giving information about the current status.
- You can resume playback from the point at which you stopped playback. Press ▶; when you see the Resume icon |▶ on the screen, press ▶ again.
→ The RESUME feature applies not only to the disc in the player, but also to the last four discs you have played. Simply reload the disc and press RETURN/RESUME on the remote control. Or, press ▶ when you see the Resume icon |▶ on the screen, then press ▶ again.

Note:

– DVDs may have a region code. The player will not play discs that have a region code different from the region code of the player.



General Features

Note:

– Unless stated, all operations described are based on remote control use. Some operations can be carried out using the menu bar on the screen.

Moving to another title/chapter

When a disc has more than one title or chapter, you can move to another title/chapter as follows:

- Press ON SCREEN, then select **T** or **C** in the menu bar.
- Press ▲ or ▼ to select a title/chapter.

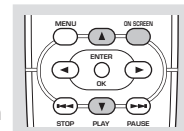

Slow Motion

- Select **S** (SLOW MOTION) in the menu bar.
- Use the ▼ buttons to enter the SLOW MOTION menu.
→ Playback will pause.
- Use the cursor buttons ◀▶ to select the required speed: -1, -1/2, -1/4 or -1/8 (backward), or +1/8, +1/4, +1/2 or +1 (forward).
- Select 1 or press ▶ to play the disc at normal speed again.
- If || is pressed, the speed will be set to zero (PAUSE).
- To exit slow motion mode, press ▲.
(Playback continues at the selected speed.)

Still Picture and Frame-by-frame playback

- Select **STP** (STEP) in the menu bar.
- Use the ▼ button to enter the step by step menu.
→ Playback will pause.
- Use the cursor buttons ◀▶ to select the previous or next picture frame.
- To exit step by step playback, press ▲.

You can also step forward by pressing || repeatedly on the remote control.

- To resume playback, press ▶.

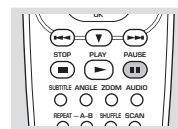

Scan

Scanning plays the first 10 seconds of each chapter/track on the disc.

- Press SCAN.
- To continue playback at your chosen chapter/track, press SCAN again or press ▶.

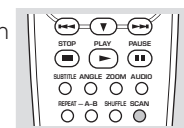

Note: This feature may not be available with some DVDs.

Search

- Select **SEARCH** (FAST MOTION) in the menu bar.
- Use the **DOWN** buttons to enter the FAST MOTION menu.
- Use the **LEFT/RIGHT** buttons to select the required speed: -32, -8 or -4 (backward), or +4, +8, +32 (forward).
- Select 1 or press **PLAY** to play the disc at normal speed again.
- To exit fast motion mode, press **UP**. (Playback continues at the selected speed.)

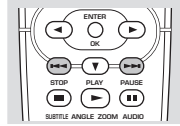

To search forward or backward through different speeds, you can also hold down **LEFT/LEFT** or **RIGHT/RIGHT**.

Repeat

DVD Video Discs

Repeat chapter/title/disc

- To repeat the current chapter, press REPEAT.
 - **REPEAT CHPT** appears on the player display.
- To repeat the current title, press **REPEAT** a second time.
 - **REPEAT TITL** appears on the player display.
- To repeat the entire disc, press **REPEAT** a third time. (This feature may not be available with some discs.)
 - **REPEAT DISC** appears on the player display.
- To exit Repeat mode, press **REPEAT** a fourth time.

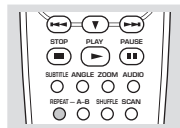

Video CDs

Repeat track/disc

- To repeat the current track, press REPEAT.
 - **REPEAT TRK** appears on the player display.
- To repeat the entire disc, press REPEAT a second time.
 - **REPEAT DISC** appears on the player display and the screen.
- To exit Repeat mode, press REPEAT a third time.

Repeat A-B

To repeat a specific portion of a title:

- Press A-B at your chosen starting point.
 - **A-** appears briefly on the screen.
- Press A-B again at your chosen end point.
 - **A-B** appears briefly on the screen, and the repeat sequence begins. (**REPEAT A-B** is displayed on the player display)
- To cancel the sequence and continue playback, press A-B.

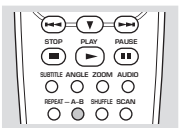

Random-sequence play

DVD Video discs

This shuffles the playing order of chapters within a title, if the title has more than one chapter:

- Press SHUFFLE during playback.
 - **SHUFFLE** appears on the screen and the player display for about two seconds.
- To return to normal playback, press SHUFFLE again.

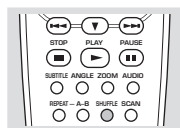

Video CDs

- Press SHUFFLE during playback.
 - **SHUFFLE** appears on the screen for about two seconds.
- To return to normal playback, press SHUFFLE again.

Time search

The Time Search function allows you to start playing at any chosen time on the disc.

- Select **TIME SEARCH** in the menu bar.
- Press **DOWN**.
 - Playback will pause.
 - A time edit box appears on the screen, showing the elapsed playing time of the current disc.
- Use the numeric buttons to enter the required start time. Enter hours, minutes and seconds from left to right in the box.
 - Each time an item has been entered, the next item will be highlighted.
- Press ENTER/OK to confirm the start time.
 - The time edit box will disappear and playback starts from the selected time on the disc.

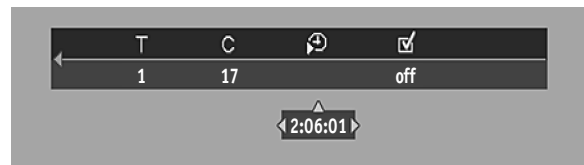

Zoom

The Zoom function allows you to enlarge the video image and to pan through the enlarged image.

- Select **Zoom** (ZOOM).
- Press **UP/DOWN** to activate the **ZOOM** function and select the required zoom factor: 1.33 or 2 or 4.
 - Playback will pause.
 - The selected zoom factor appears below the Zoom icon in the menu bar, and 'Press OK to pan' appears below the menu bar.
 - The picture will change accordingly.
- Press ENTER/OK to confirm the selection.
 - The panning icons appear on the screen.
- Use the **LEFT/RIGHT/UP/DOWN** buttons to pan across the screen.
- When ENTER/OK is pressed only the zoomed picture will be shown on the screen.
- To exit **ZOOM** mode:
 - Press **PLAY** to resume playback.



FTS-Video

- The FTS-Video function allows you to store your favorite titles and chapters (DVD) and favorite tracks and indexes (VCD) for a particular disc in the player memory.
- FTS program can contain 20 items (titles, chapters etc.).

Storing an FTS-Video Program

- While playback is stopped, select **VIDEO FTS** in the menu bar.
- Press **▼** to open the menu.
→ The **VIDEO FTS** menu appears.

Storing titles/tracks

- Press **▼** to select **TITLES**.
- Use **▶** and **◀** to select the required title.
- Press ENTER/OK if you wish to store the entire title.
→ The title number will be added to the list of selections.

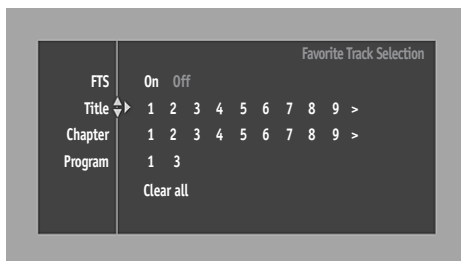

Storing chapters/indexes

- Press **▼** on the selected title number.
→ The title number will be marked and the highlight moves to the first available chapter number for this title.
- Use **▶** and **◀** to select the required chapter number.
- Press ENTER/OK to confirm the selection.
→ The title/chapter selection will be added to the list of selections.
- To start FTS playback, press **▶** when FTS is On.
- Press ON SCREEN to exit the **VIDEO FTS** menu.

Erasing an FTS-Video Program

- Select **VIDEO FTS** in the menu bar.
- Use **▼** to select **PROGRAM**.
- Use **▶** and **◀** to select the required number.
- Press ENTER/OK to erase the selection.
- Press ON SCREEN to exit.

Erasing all selections

- While playback is stopped, select **VIDEO FTS** in the menu bar.
- Use **▼** to select **CLEAR ALL**.
- Press ENTER/OK.
→ All selections will be erased.
- Press ON SCREEN to exit.

Switching FTS ON/OFF

- 1 Use **▲** to move to FTS.
- 2 Use **▶** or **◀** to select either On or Off.

Special DVD Features

Checking the contents of DVD Video discs: Menus

DVDs may contain menus to navigate the disc and access special features. To use the menu, press the appropriate numeric button or use the **▼**, **▲**, **▶**, **◀** to highlight your selection, then press ENTER/OK.

Title/Disc menu

- Press MENU.
→ If the current title has a menu, the menu will appear on the screen. Otherwise, the disc menu will be displayed.
- The menu can list camera angles, spoken language and subtitle options, and chapters for the title.

Camera Angle

If the disc contains sequences recorded from different camera angles, the angle icon appears, showing the number of available angles and the angle being shown currently. You can then change the camera angle if you wish.

- Press ANGLE or **▲/▼** to select the required angle.
→ After a while, playback changes to the selected angle. The angle icon remains displayed until multiple angles are no longer available.



Changing the audio format and/or language

- Select **[[[(AUDIO)** in the menu bar.
- Press **AUDIO** or **▲/▼** repeatedly to see the different format and/or languages.



Subtitles

- Select **[...] (SUBTITLE)** in the menu bar.
- Press **SUBTITLE** or **▲/▼** repeatedly to see the different subtitles.



Note:

With some discs, you cannot change angles, audio formats and/or Languages, or subtitles in the way described above. In that case, go to the disc menu to change them.

Special Video CD & SVCD Features

Playback Control (PBC)

- Load a Video CD with PBC and press ►.
- Go through the menu with the buttons indicated on the screen until your chosen passage starts to play. If a **PBC** menu consists of a list of titles, you can select a title directly.
- Enter your choice with the numeric buttons (0-9).
- Press RETURN/RESUME to go back to the previous menu.
- You may also select **PBC OFF** under Personal Preferences.

Note: When PBC is on, you cannot operate random, repeat, A-B repeat, scan time search and FTS video with video CD's version 2.0.

Playing an Audio CD

- After loading the disc, playback starts automatically.
- If the TV is on, the Audio CD screen appears.
- The number of tracks and the total playing time of the disc will be shown on the screen.
- During playback, the current track number and its elapsed playing time will be shown on the screen and on the player display.
- Playback will stop at the end of the disc.
- To stop playback at any other time, press ■.

Audio Disk Mode									
Play	Track	Time	Total tracks	Total time					
▶	1	0.00.39	15	1.17.02					
FTS ▶ On Off									
Track	1	2	3	4	5	6	7	8	>
Program	11	14							
Clear all									

Pause

- Press **II** during playback.
- To return to playback, press ►.

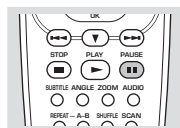

Search

- To search forward or backward through the disc at four times the normal speed, hold down **◀◀** or **▶▶** for about one second during playback.
 - Search begins, and sound is partially muted.
- To step up to eight times the normal speed, press **◀◀◀** or **▶▶▶** again.
 - Search goes to eight times the speed, and the sound is muted.
- To return to four times the normal speed, press **◀◀** or **▶▶** again.
- If the TV is on, search speed and direction are indicated on the screen each time **◀◀** or **▶▶** is pressed.
- To end the search, press **▶** to resume playback or press **II** to pause or press **■** to stop playback.

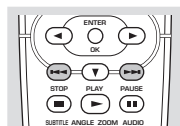

Moving to another track

- Press **◀◀** or **▶▶** briefly during playback to go to the next track or to return to the beginning of the current track.
- Press **◀◀** twice briefly to step back to the previous track.
- To go directly to any track, enter the track number using the numeric buttons (0-9).

Random-sequence play

- Press **SHUFFLE** during playback.
 - The playing order of the tracks is changed.
- To return to normal playback, press **SHUFFLE** again.

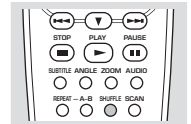

Repeat track/disc

- To repeat the current track, press **REPEAT**.
 - **REPEAT TRK** appears on the player display.
- To repeat the entire disc, press **REPEAT** a second time.
 - **REPEAT DISC** appears on the player display.
- To exit Repeat mode, press **REPEAT** a third time.

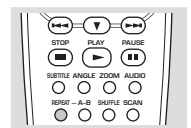

Repeat A-B

- To repeat a specific portion of a track:
 - Press **A-B** at your chosen starting point.
 - **repeat A-** appears on the screen.
 - Press **A-B** again at your chosen end point.
 - **repeat A-B** appears on the screen, and the sequence begins to play repeatedly.
- To cancel the sequence and continue playback, press **A-B**.

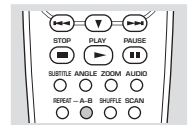

Scan

- Scanning plays the first 10 seconds of each track on the disc.
- Press **SCAN**.
- To continue playback at your chosen track, press **SCAN** again or press **▶**.

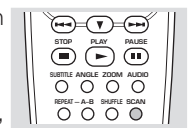

Favorite Track Selection (FTS) Program

- The FTS Program allows you to store your favorite tracks for a particular disc in the player memory.
- Each FTS Program can contain 20 tracks.

Audio Disk Mode									
Stop	Track	Time	Total tracks	Total time					
■	--	-.--	15	1.17.02					
FTS ▶ On Off									
Track	1	2	3	4	5	6	7	8	>
Program	11	14							
Clear all									

Storing an FTS Program

- 1 Load a disc and stop playback.
- 2 Use ▼ to go to the list of available tracks.
- 3 Use ► or ◀ to select tracks from the list.
To go directly to any track, enter the track number using the numeric buttons (0-9).
- 4 Store each track by pressing ENTER/OK.
→ The track numbers will be added to the list.
→ The number of tracks and the playing time of the program will be shown on the screen and the player display.

When your FTS Program is complete, press ► to start playback or; press ▲ to go back to Stop mode. In either case, the FTS Program will be automatically memorized.

Switching FTS ON/OFF

- 1 Use ▲ to move to FTS.
- 2 Use ► or ◀ to select either On or Off.

Erasing a track from an FTS Program

- 1 Use ▼ to go to the list of selected tracks.
- 2 Use ► and ◀ to select the track number you wish to erase.
- 3 Press ENTER/OK.
→ The track number will be erased from the list of selected tracks.

Erasing the complete program

- 1 Use ▼ to select **CLEAR ALL**, then press ENTER/OK.
→ The complete FTS Program for the disc will be erased.

MP3 Disc Features

Support following MP3-CD formats (ISO9660 format):

- Max. 30 characters (filename or directory)
- Max. nested directory is 8 levels
- The max. album (directory) number is 32
- Supported variable bit-rate
- Supported sampling frequencies for MP3 disc are: 32 kHz, 44.1 kHz, 48 kHz
- Supported Bit-rates of MP3 disc are: 32, 64, 96, 128, 192, 256 (kbps)

Following formats can't be supported

- The files like *.WMA, *.AAC, *.DLF, *.M3U, *.PLS
- Chinese filename
- The non-session closed discs
- The discs recorded under UDF format

Downloading MP3 files from the Internet or copying songs from your own legal discs is a delicate process.

Sound Quality	Bit Rate	Approximate Reduction Ratio	Approximate total MP3-CD time	Comment
AM radio	32 kbps	40 : 1	40 hrs	Sound quality significantly affected – not recommended.
FM radio	64 kbps	20 : 1	20 hrs	
Near-CD	96 kbps	15 : 1	15 hrs	Balanced sound quality – compression rate
CD-like	128 kbps	10 : 1	10 hrs	
CD*	256 kbps	5 : 1	5 hrs	Compression rate low – suggest to play CDs instead
CD*	320 kbps	3 : 1	3 hrs	

You may experience an occasional “skip” while listening to your MP3 files. This is normal.

Additional note for MP3 disc Playback:

- In compliance with the SDMI, digital-out is muted while playing MP3 discs.
- Due to the recording nature of Digital Audio MP3 (DAM), only Digital Audio music will play.
- The disc reading time may exceed 10 seconds due to the large number of songs compiled into one disc.
- Only the first session of multisession discs is supported.
- Some MP3 discs cannot be played depending on the disc characteristics or recording conditions.

Album/Title

This feature allows you to view and select the next or previous MP3 disc Album/Title.

- 1 Press ▲/▼ to scroll through the previous or next Album.
- 2 Press ◀► to scroll through the previous or next Track.

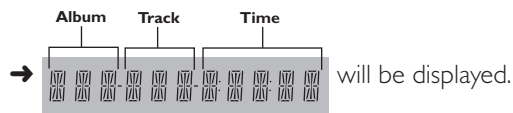

- 3 You can also select the desired album/track number directly using the numeric buttons on the remote control.

Note:

- **In STOP mode:** numbers are used for ALBUM selection.
- **In PLAY mode:** numbers are used for TRACK selection.
- Only the following functions are possible for MP3 discs:
 - STOP / PLAY / PAUSE
 - SKIP NEXT / PREVIOUS
 - REPEAT (TRACK / ALBUM / DISC)

MP3 Discs - Album/Track/Disc

- To repeat a track, press REPEAT.
→ **REPEAT TRK** appears on the player display.
- To repeat an album, press REPEAT a second time.
→ **REPEAT ALBM** appears on the player display.
- To repeat the entire disc, press REPEAT a third time.
→ **REPEAT DISC** appears on the player display.

Deciding the PIN number

When changing Access control settings, first decide your PIN number. You need to enter the number whenever you change the settings.

- 1 Select **ACCESS CONTROL** in the features menu using ▲/▼, and then press ►.
- 2 Enter your 4-digit code of your own choice.
- 3 Enter the code a second time.

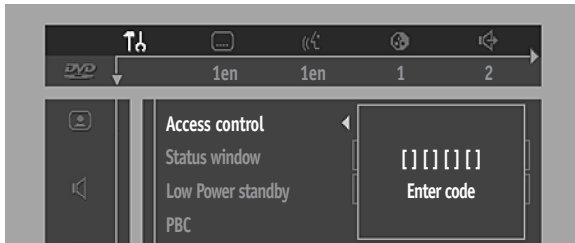

Access Control: Child Lock (DVD Video and Video CD)

Activating/deactivating the Child Lock

- 1 Select **ACCESS CONTROL** in the features menu using the ▲/▼, and then press ►.
- 2 Enter your 4-digit code of your own choice.
- 3 Move to **"CHILD LOCK"** using the ▲/▼.
- 4 Move to **LOCK/UNLOCK** using the ►.
- 5 Select **LOCK** using the ▲/▼.
- 6 Press ENTER/OK or ◀ to confirm, then press ◀ again to exit the menu.
→ Now unauthorized discs will not be played unless the 4-digit code is entered.
- 7 Select **UNLOCK** to deactivate the **CHILD LOCK**.

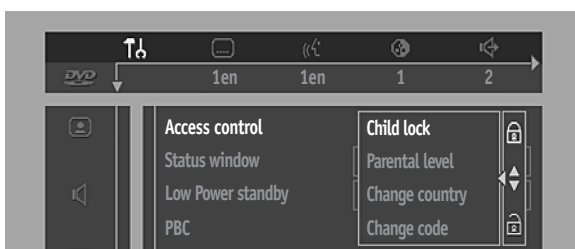

Authorizing discs

- Insert the disc. See 'Loading discs'.
→ The 'child protect' dialog will appear. You will be asked to enter your secret code for 'Playback Once' or 'Playback Always'. If you select 'Playback Once', the disc can be played as long as it is in the player and the player is ON. If you select 'Playback Always', the disc will become child safe (authorized) and can always be played, even if the Child Lock is set to ON.

Notes:

- The player memory maintains a list of 80 authorized ('Child safe') disc titles. A disc will be placed in the list when 'Playback Always' is selected in the 'child protect' dialog.
- Each time a 'child safe' disc is played, it will be placed on top of the list. When the list is full and a new disc is added, the last disc in the list will be removed from the list.
- Double-sided DVDs may have a different ID for each side. In order to make the disc 'child safe', each side has to be authorized.
- Multi-volume VCDs may have a different ID for each volume. In order to make the complete set 'child safe', each volume has to be authorized.

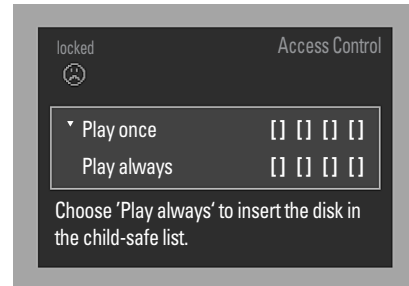

Deauthorizing discs

- Insert the disc. See 'Loading discs'.
→ Playback starts automatically.
- Press ■ while 😊 is visible.
→ The 😞 will appear and the disc is now deauthorized.

Note:

Playback continues even after you have deauthorized the disc. Press ■ if you want to stop it.

Access Control: Parental Control (DVD Video only)

Movies on DVDs may contain scenes not suitable for children. Therefore, discs may contain 'Parental Control' information which applies to the complete disc or to certain scenes on the disc. These scenes are rated from 1 to 8, and alternative, more suitable scenes are available on the disc. Ratings are country dependent. The 'Parental Control' feature allows you to prevent discs from being played by your children or to have certain discs played with alternative scenes.

Activating/Deactivating Parental Control

- 1 Select **ACCESS CONTROL** in the features menu using the ▲/▼, and then press ►.
- 2 Enter your 4-digit code. If necessary, enter the code a second time.
- 3 Move to **Parental Control** using the ▲/▼.
- 4 Move to **VALUE ADJUSTMENT** (0-8) using the ►.
- 5 Then use the ▲/▼ or the numeric buttons on the remote control to select a rating from 0 to 8 for the disc inserted.

Rating 0 (displayed as '—'):

Parental Control is not activated. The Disc will be played in full.

Ratings 1 to 8:

The disc contains scenes not suitable for children. If you set a rating for the player, all scenes with the same rating or lower will be played. Higher rated scenes will not be played unless an alternative is available on the disc. The alternative must have the same rating or a lower one. If no suitable alternative is found, playback will stop and the 4-digit code has to be entered.

- 6 Press ENTER/OK or ◀ to confirm, then press ◀ again to exit the menu.

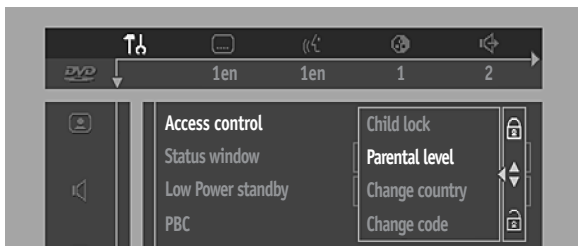

Country

- 1 When disc playback is stopped, select **ACCESS CONTROL** in the features menu using the ▲/▼, and then press ►.
- 2 Enter the 4-digit code.
- 3 Move to **CHANGE COUNTRY** using the ▼.
- 4 Press the ►.
- 5 Select a country using ▲/▼.
- 6 Press ENTER/OK or ◀ to confirm, then press ◀ again to exit the menu.

Changing the 4-digit code

- 1 Select **ACCESS CONTROL** in the features menu using the ▲/▼, and then press ►.
- 2 Enter the old code.
- 3 Move to **CHANGE CODE** using the ▼.
- 4 Press the ►.
- 5 Enter the new 4-digit code.
- 6 Enter the code a second time and reconfirm by pressing ENTER/OK.
- 7 Press ◀ to exit the menu.

If you forget your 4 digit code

- 1 Press ■ to exit the 'Child Protect' screen.
- 2 Select **ACCESS CONTROL** in the features menu using the ▲/▼, and then press ►.
- 3 The 4-digit code can be cancelled by pressing ■ four times in the 'Access Control' dialog.
- 4 You can then enter a new code (twice!) as described above (Changing the 4 digit code).

Parental Control Disclaimer

This player features the **PARENTAL CONTROL** system which is intended to activate when playing DVD discs furnished with certain software coding. This is according to technical standards adopted by the set maker and disc content industries.

Please note that the **PARENTAL CONTROL** system will not operate a DVD disc which is not furnished with the appropriate software coding. Also note that at the time of release of the player, certain aspects of the technical standards had not been settled between set makers and the disc industries.

On this basis, Yamaha cannot guarantee the functioning of the **PARENTAL CONTROL** system and denies any liability associated with unintended watching of disc content.

If in doubt, please make sure the disc plays according to your **PARENTAL CONTROL** settings before you allow children access to the player.

Before Requesting Service

If it appears that the player is faulty, first consult this checklist. Something may have been overlooked. Under no circumstances should you attempt to repair the system yourself.

Look for the specific symptom(s). Then perform only the actions listed to remedy the specific symptom(s).

Symptom	Remedy
No power	<ul style="list-style-type: none">– Make sure the power cord is properly connected.– Check if there is power at the AC outlet by plugging in another appliance.
No picture	<ul style="list-style-type: none">– Check if the TV is switched on.– Check the video connection.
Distorted picture	<ul style="list-style-type: none">– Check the disc for fingerprints and clean the disc with a soft cloth, wiping from the center to the edge in a straight line.– Sometimes a small amount of picture distortion may appear. This is not a malfunction.
Completely distorted picture or no color with the player menu	<ul style="list-style-type: none">– If the picture is distorted completely or if the picture rolls vertically, make sure the NTSC/PAL setting at the player matches the video signal of your television.– If your TV video signal is NTSC, select the NTSC setting at the player.– If your video signal is PAL, select the PAL setting. - See NTSC/PAL SETTINGS.
Distorted or black/white picture with DVD or Video CD	<ul style="list-style-type: none">– The disc format does not match your TV's video signal (PAL/NTSC).
No sound	<ul style="list-style-type: none">– Check audio connections.– If you are using a HiFi amplifier, try another sound source.
Distorted sound from HiFi amplifier	<ul style="list-style-type: none">– Check to make sure that no audio connections are made to the amplifier's phono input.
No audio at digital output	<ul style="list-style-type: none">– Check the digital connections.– Check the settings menu to make sure the digital output is set to ALL or PCM only.– Check if the selected audio format matches your receiver capabilities.
Disc can't be played	<ul style="list-style-type: none">– Ensure the disc label is facing up.– Clean the disc.– Check if the disc is defective by trying another disc.– Check to see if the disc is defective, badly scratched or warped (not flat).
No return to start-up screen when disc is removed	<ul style="list-style-type: none">– Reset the unit by switching the player off, then on again.– Check to see if the program requires another disc to be loaded.
The player does not respond to the remote control	<ul style="list-style-type: none">– Aim the remote control directly at the sensor on the front of the player.– Remove any obstacles between the player and the remote control.– Inspect or replace the batteries in the remote control.
Buttons do not work	<ul style="list-style-type: none">– In order to completely reset the player, unplug the AC cord from the AC outlet. (Please ensure that the set is not in Initial Setup mode.)
The player does not respond to some operating commands during playback	<ul style="list-style-type: none">– Operations may not be permitted by the disc. Refer to the instructions of the disc.

Specifications

PLAYBACK SYSTEM

DVD Video
Video CD & SVCD
CD (CD-Recordable and CD-Rewritable)
DVD+RW
MP3

OPTICAL READOUT SYSTEM

Lasertype	Semiconductor AlGaAs	
Numerical Aperture	0.60 (DVD)	
	0.45 (VCD/CD)	
Wavelength	650 nm (DVD)	
	780 nm (VCD/CD)	

DVD DISC FORMAT

Medium	Optical Disc	
Diameter	12cm (8cm)	
Playing time (12cm)	One layer	2.15 h*
	Dual layer	4 h*
	Two side	4.30 h*
	Single layer	
	Two side	8 h*
	Dual layer	

VIDEO FORMAT

DA Converter	10 bits
Signal handling	Components
Digital Compression	MPEG2 for DVD, MPEG1 for VCD

TV STANDARD

	(PAL/50Hz)	(NTSC/60Hz)
Number of lines	625	525
Playback	Multistandard	(PAL/NTSC)

DVD

Horizontal Resolution	720 pixels	720 pixels
Vertical Resolution	576 lines	480 lines

VCD

Horizontal Resolution	352 pixels	352 pixels
Vertical Resolution	288 lines	240 lines

VIDEO PERFORMANCE

Video output	1 Vpp into 75 ohm
S-Video output	Y: 1 Vpp into 75 ohm C: 0.3 Vpp into 75 ohm
Component video output	Y: 1 Vpp into 75 ohm Pb/Cb Pr/Cr: 0.7 Vpp into 75 ohm
Black Level Shift	On/Off
Video Shift	Left/Right

AUDIO FORMAT

Digital	MPEG	Compressed Digital
	DTS/Dolby Digital	
	PCM	
	16, 20, 24 bits	
	fs, 44.1, 48, 96 kHz	

Analog Sound Stereo
Dolby Pro Logic downmix from Dolby Digital multi-channel sound
3D Sound (TruSurround) for virtual 5.1 channel sound on 2 speakers

AUDIO PERFORMANCE

DA Converter	24 bits	
DVD	fs 96 kHz	2 Hz - 44 kHz
	fs 48 kHz	2 Hz - 22 kHz
	fs 44.1 kHz	2 Hz - 20 kHz
Video CD	fs 44.1 kHz	
CD	fs 44.1 kHz	
Signal-Noise (1kHz)	95dB	
Dynamic Range (1kHz)	95dB	
Distortion and Noise (1kHz)	0.0035%	
MPEG MP3	MPEG Audio L3	

CONNECTIONS

Y Output	Cinch (green)
Pb/Cb Output	Cinch (blue)
Pr/Cr Output	Cinch (red)
S-Video Output	Mini DIN, 4 pins
Video Output	Cinch (yellow)
Audio L+R output	Cinch (white/red)
Subwoofer output	Cinch (black)
Digital Output	1 coaxial, 1 optical
	IEC958 for CDDA / LPCM
	IEC1937 for MPEG1/2, Dolby Digital and DTS

GENERAL

Dimensions (w x h x d)	435 x 91 x 314 mm (17.12 x 3.64 x 12.56 inch)
Weight	Approximately 3.3 Kg (7.3 pounds)
Power Supply	
U.S.A. and Canada model	120V, 60Hz
Australia model	240V, 50Hz
Power Consumption	
U.S.A. and Canada model	20W (2.4W in standby mode)
Australia model	20W (4.3W in standby mode)

GENERAL FUNCTIONALITY

Stop / Play / Pause
Fast Forward / Backward
Time Search
Step Forward / Backward
Slow Motion
Title / Chapter / Track Select
Skip Next / Previous
Repeat (Chapter / Title / All) or (Track / All)
A-B Repeat
Random
Scan
New enhanced user graphical interface
Zoom (x1.33, x2, x4) with picture enhancement
Smart Picture for convenient personal color setting
NTSC/PAL Conversion
Screen Saver (Dim 75% after 15 minutes)
3D Sound (TruSurround)
Audio and video bit rate indicator

DVD FUNCTIONALITY

Multi-angle Selection
Audio Selection (one out of maximum eight languages)
Subtitles Selection (one out of maximum 32 languages)
Aspect Ratio conversion (16:9, 4:3 Letterbox, 4:3 Pan Scan)
Parental Control and Child Lock
Disc Menu support (Title Menu and Access Control)
Resume (5 discs) after stop / standby
Programming Titles/chapters with Favorite Track Selection

VIDEO CD FUNCTIONALITY

Playback Control for VCD 2.0 discs
Child Lock
Resume (5 discs) after stop / standby
Programming Tracks with Favorite Track Selection

AUDIO CD FUNCTIONALITY

Time Display (Total / Track)
Full audio functionality with remote control
Programming with Favorite Track Selection

MP3 FUNCTIONALITY

Time Display (Track)
Album and Track Selection
Repeat (Disc / Album / Track)

* typical playing time for movie with 2 spoken languages and 3 subtitle languages

Specifications subject to change without prior notice



YAMAHA ELECTRONICS CORPORATION, USA 6660 ORANGETHORPE AVE., BUENA PARK, CALIF. 90620, U.S.A.
YAMAHA CANADA MUSIC LTD. 135 MILNER AVE., SCARBOROUGH, ONTARIO M1S 3R1, CANADA
YAMAHA ELECTRONIK EUROPA G.m.b.H. SIEMENSSTR. 22-34, 25462 RELLINGEN BEI HAMBURG, F.R. OF GERMANY
YAMAHA ELECTRONIQUE FRANCE S.A. RUE AMBROISE CROIZAT BP70 CROISSY-BEAUBOURG 77312 MARNE-LA-VALLEE CEDEX02, FRANCE
YAMAHA ELECTRONICS (UK) LTD. YAMAHA HOUSE, 200 RICKMANSWORTH ROAD WATFORD, HERTS WD1 7JS, ENGLAND
YAMAHA SCANDINAVIA A.B. J A WETTERGRENS GATA 1, BOX 30053, 400 43 VÄSTRA FRÖLUNDA, SWEDEN
YAMAHA MUSIC AUSTRALIA PTY, LTD. 17-33 MARKET ST., SOUTH MELBOURNE, 3205 VIC., AUSTRALIA

YAMAHA CORPORATION
3139 246 11392 Printed in China