



MUSIC SYNTHESIZER
SYNTHÉTISEUR MUSICAL
SINTETIZADOR MUSICAL

MODX6 +
MODX7 +
MODX8 +

Owner's Manual
Mode d'emploi
Manual de instrucciones

English

Français

Español

EN
FR
ES

The model number, serial number, power requirements, etc., may be found on or near the name plate, which is at the bottom of the unit. You should note this serial number in the space provided below and retain this manual as a permanent record of your purchase to aid identification in the event of theft.

Model No.

Serial No.

(1003-M06 plate bottom en 01)

Le numéro de modèle, le numéro de série, l'alimentation requise, etc., se trouvent sur ou près de la plaque signalétique du produit, située dans la partie inférieure de l'unité. Notez le numéro de série dans l'espace fourni ci-dessous et conservez ce manuel en tant que preuve permanente de votre achat afin de faciliter l'identification du produit en cas de vol.

N° de modèle

N° de série

(1003-M06 plate bottom fr 01)

El número de modelo, el número de serie, los requisitos de alimentación, etc. pueden encontrarse en la placa de identificación o cerca de ella. Esta placa se encuentra en la parte inferior de la unidad. Debe anotar dicho número en el espacio proporcionado a continuación y conservar este manual como comprobante permanente de su compra para facilitar la identificación en caso de robo.

N° de modelo

N° de serie

(1003-M06 plate bottom es 01)

FCC INFORMATION (U.S.A.)

1. IMPORTANT NOTICE: DO NOT MODIFY THIS UNIT!

This product, when installed as indicated in the instructions contained in this manual, meets FCC requirements. Modifications not expressly approved by Yamaha may void your authority, granted by the FCC, to use the product.

2. IMPORTANT:

When connecting this product to accessories and/or another product use only high quality shielded cables. Cable/s supplied with this product MUST be used. Follow all installation instructions. Failure to follow instructions could void your FCC authorization to use this product in the USA.

3. NOTE:

This product has been tested and found to comply with the requirements listed in FCC Regulations, Part 15 for Class "B" digital devices. Compliance with these requirements provides a reasonable level of assurance that your use of this product in a residential environment will not result in harmful interference with other electronic devices. This equipment generates/uses radio frequencies and, if not installed and used according to the instructions found in the users manual, may cause interference harmful to the operation of other electronic devices. Compliance with FCC regulations does not guarantee that interference will not occur in all installations. If this product is found to be the source of interference, which can be determined by turning the unit "OFF" and "ON", please try to eliminate the problem by using one of the following measures:

- Relocate either this product or the device that is being affected by the interference.
- Utilize power outlets that are on different branch (circuit breaker or fuse) circuits or install AC line filter/s.
- In the case of radio or TV interference, relocate/reorient the antenna. If the antenna lead-in is 300 ohm ribbon lead, change the lead-in to co-axial type cable.

If these corrective measures do not produce satisfactory results, please contact the local retailer authorized to distribute this type of product. If you cannot locate the appropriate retailer, please contact Yamaha Corporation of America, 6600 Orangethorpe Ave., Buena Park, CA90620, USA.

The above statements apply ONLY to those products distributed by Yamaha Corporation of America or its subsidiaries.

(529-M04 FCC class B YCA 01)

COMPLIANCE INFORMATION STATEMENT (Supplier's declaration of conformity procedure)

Responsible Party: Yamaha Corporation of America
Address: 6600 Orangethorpe Ave., Buena Park, Calif. 90620
Telephone: 714-522-9011
Type of Equipment: MUSIC SYNTHESIZER
Model Name: MODX6+, MODX7+, MODX8+

This device complies with Part 15 of the FCC Rules.

Operation is subject to two following conditions:

- 1) this device may not cause harmful interference, and
- 2) this device must accept any interference received including interference that may cause undesired operation.

(529-M02 FCC sdoc YCA 01)

For AC adaptor

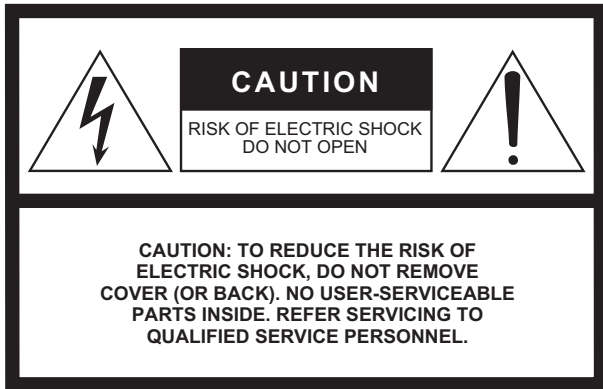

Explanation of Graphical Symbols

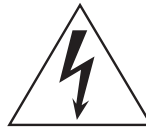

The lightning flash with arrowhead symbol within an equilateral triangle is intended to alert the user to the presence of uninsulated “dangerous voltage” within the product’s enclosure that may be of sufficient magnitude to constitute a risk of electric shock to persons.



The exclamation point within an equilateral triangle is intended to alert the user to the presence of important operating and maintenance (servicing) instructions in the literature accompanying the product.

IMPORTANT SAFETY INSTRUCTIONS

- 1 Read these instructions.
- 2 Keep these instructions.
- 3 Heed all warnings.
- 4 Follow all instructions.
- 5 Do not use this apparatus near water.
- 6 Clean only with dry cloth.
- 7 Do not block any ventilation openings. Install in accordance with the manufacturer’s instructions.
- 8 Do not install near any heat sources such as radiators, heat registers, stoves, or other apparatus (including amplifiers) that produce heat.
- 9 Do not defeat the safety purpose of the polarized or grounding-type plug. A polarized plug has two blades with one wider than the other. A grounding type plug has two blades and a third grounding prong. The wide blade or the third prong are provided for your safety. If the provided plug does not fit into your outlet, consult an electrician for replacement of the obsolete outlet.
- 10 Protect the power cord from being walked on or pinched particularly at plugs, convenience receptacles, and the point where they exit from the apparatus.
- 11 Only use attachments/accessories specified by the manufacturer.
- 12 Use only with the cart, stand, tripod, bracket, or table specified by the manufacturer, or sold with the apparatus. When a cart is used, use caution when moving the cart/apparatus combination to avoid injury from tip-over.
- 13 Unplug this apparatus during lightning storms or when unused for long periods of time.
- 14 Refer all servicing to qualified service personnel. Servicing is required when the apparatus has been damaged in any way, such as power-supply cord or plug is damaged, liquid has been spilled or objects have fallen into the apparatus, the apparatus has been exposed to rain or moisture, does not operate normally, or has been dropped.



WARNING

TO REDUCE THE RISK OF FIRE OR ELECTRIC SHOCK, DO NOT EXPOSE THIS APPARATUS TO RAIN OR MOISTURE.

(UL60065_03)

Adaptateur secteur



Explication des symboles graphiques



L'éclair avec une flèche à l'intérieur d'un triangle équilatéral est destiné à attirer l'attention de l'utilisateur sur la présence d'une « tension dangereuse » non isolée à l'intérieur de l'appareil, pouvant être suffisamment élevée pour constituer un risque d'électrocution.



Le point d'exclamation à l'intérieur d'un triangle équilatéral est destiné à attirer l'attention de l'utilisateur sur la présence d'instructions importantes sur l'emploi ou la maintenance (réparation) de l'appareil dans la documentation fournie.

PRÉCAUTIONS CONCERNANT LA SÉCURITÉ

- 1 Lisez les instructions ci-après.
- 2 Conservez ces instructions.
- 3 Tenez compte des avertissements.
- 4 Suivez toutes les instructions.
- 5 N'utilisez pas cet instrument dans un milieu humide.
- 6 Employez uniquement un chiffon sec pour nettoyer l'instrument.
- 7 N'obstruez pas les ouvertures prévues pour la ventilation. Installez l'instrument conformément aux instructions du fabricant.
- 8 N'installez pas l'instrument près d'une source de chaleur, notamment un radiateur, une bouche de chaleur, un poêle ou autres (y compris les amplificateurs).
- 9 Ne modifiez pas les caractéristiques de la fiche avec mise à la terre polarisée. Une fiche polarisée est dotée de deux broches (l'une est plus large que l'autre). Une fiche avec mise à la terre comprend deux broches, ainsi qu'une troisième qui relie l'instrument à la terre. La broche la plus large (ou troisième broche) permet de sécuriser l'installation électrique. Si vous ne pouvez pas brancher le cordon d'alimentation dans la prise d'alimentation, demandez à un électricien de la remplacer.
- 10 Protégez le cordon d'alimentation. Cela permet d'éviter de marcher dessus ou de le tordre au niveau de la fiche, de la prise d'alimentation et des points de contact sur l'instrument.
- 11 N'employez que les dispositifs/accessoires indiqués par le fabricant.
- 12 Utilisez uniquement le chariot, le socle, le trépied, le support ou le plan indiqués par le fabricant ou livrés avec l'instrument. Si vous utilisez un chariot, soyez prudent si vous le déplacez avec l'instrument posé dessus pour éviter de le renverser.
- 13 Débranchez l'instrument en cas d'orage ou lorsque vous ne l'utilisez pas pendant des périodes prolongées.
- 14 Confiez toutes les réparations à des techniciens qualifiés. Des réparations sont nécessaires lorsque l'instrument est endommagé, notamment dans les cas suivants : cordon d'alimentation ou fiche défectueuse, liquides ou objets projetés sur l'appareil, exposition aux intempéries ou à l'humidité, fonctionnement anormal ou chute.



AVERTISSEMENT

N'UTILISEZ PAS L'INSTRUMENT SOUS LA PLUIE OU DANS UN ENVIRONNEMENT HUMIDE, FAUTE DE QUOI VOUS RISQUEZ DE PROVOQUER UN INCENDIE OU DE VOUS ÉLECTROCUTER.

(502-M01 UL 60065-1 fr 01)

PRECAUTIONS

PLEASE READ CAREFULLY BEFORE PROCEEDING

Please keep this manual in a safe and handy place for future reference.

For AC adaptor



WARNING

- This AC adaptor is designed for use with only Yamaha electronic instruments. Do not use for any other purpose.
- Indoor use only. Do not use in any wet environments.



CAUTION

- When setting up, make sure that the AC outlet is easily accessible. If some trouble or malfunction occurs, immediately turn off the power switch of the instrument and disconnect the AC adaptor from the outlet. When the AC adaptor is connected to the AC outlet, keep in mind that electricity is flowing at the minimum level, even if the power switch is turned off. When you are not using the instrument for a long time, make sure to unplug the power cord from the wall AC outlet.

For MODX+



WARNING

Always follow the basic precautions listed below to avoid the possibility of serious injury or even death from electrical shock, short-circuiting, damages, fire or other hazards. These precautions include, but are not limited to, the following:

Power supply/AC adaptor

- Do not place the power cord near heat sources such as heaters or radiators. Also, do not excessively bend or otherwise damage the cord, or place heavy objects on it.
- Only use the voltage specified as correct for the instrument. The required voltage is printed on the name plate of the instrument.
- Use the specified adaptor (page 71) only. Using the wrong adaptor can result in damage to the instrument or overheating.
- Check the electric plug periodically and remove any dirt or dust which may have accumulated on it.

Do not open

- This instrument contains no user-serviceable parts. Do not open the instrument or attempt to disassemble or modify the internal components in any way. If it should appear to be malfunctioning, discontinue use immediately and have it inspected by qualified Yamaha service personnel.

Water warning

- Do not expose the instrument to rain, use it near water or in damp or wet conditions, or place on it any containers (such as vases, bottles or glasses) containing liquids which might spill into any openings. If any liquid such as water seeps into the instrument, turn off the power immediately and unplug the power cord from the AC outlet. Then have the instrument inspected by qualified Yamaha service personnel.
- Never insert or remove an electric plug with wet hands.

Fire warning

- Do not put burning items, such as candles, on the unit. A burning item may fall over and cause a fire.

If you notice any abnormality

- When one of the following problems occur, immediately turn off the power switch and disconnect the electric plug from the outlet. Then have the device inspected by Yamaha service personnel.
 - The power cord or plug becomes frayed or damaged.
 - It emits unusual smells or smoke.
 - Some object has been dropped into the instrument.
 - There is a sudden loss of sound during use of the instrument.

CAUTION

Always follow the basic precautions listed below to avoid the possibility of physical injury to you or others, or damage to the instrument or other property. These precautions include, but are not limited to, the following:

Power supply/AC adaptor

- Do not connect the instrument to an electrical outlet using a multiple-connector. Doing so can result in lower sound quality, or possibly cause overheating in the outlet.
- When removing the electric plug from the instrument or an outlet, always hold the plug itself and not the cord. Pulling by the cord can damage it.
- Remove the electric plug from the outlet when the instrument is not to be used for extended periods of time, or during electrical storms.

Location

- Do not place the instrument in an unstable position where it might accidentally fall over.
- Do not place the instrument against a wall (allow at least 3 cm/ one-inch from the wall), since this can cause inadequate air circulation, and possibly result in the instrument overheating.
- When transporting or moving the instrument, always use two or more people. Attempting to lift the instrument by yourself may damage your back, result in other injury, or cause damage to the instrument itself.
- Before moving the instrument, remove all connected cables, to prevent damage to the cables or injury to anyone who might trip over them.
- When setting up the product, make sure that the AC outlet you are using is easily accessible. If some trouble or malfunction occurs, immediately turn off the power switch and disconnect the plug from the outlet. Even when the power switch is turned off, electricity is still flowing to the product at the minimum level. When you are not using the product for a long time, make sure to unplug the power cord from the wall AC outlet.

Connections

- Before connecting the instrument to other electronic components, turn off the power for all components. Before turning the power on or off for all components, set all volume levels to minimum.
- Be sure to set the volumes of all components at their minimum levels and gradually raise the volume controls while playing the instrument to set the desired listening level.

Handling caution

- Do not insert a finger or hand in any gaps on the instrument.
- Never insert or drop paper, metallic, or other objects into the gaps on the panel or keyboard. This could cause physical injury to you or others, damage to the instrument or other property, or operational failure.
- Do not rest your weight on, or place heavy objects on the instrument, and do not use excessive force on the buttons, switches or connectors.
- Do not use the instrument/device or headphones for a long period of time at a high or uncomfortable volume level, since this can cause permanent hearing loss. If you experience any hearing loss or ringing in the ears, consult a physician.

Yamaha cannot be held responsible for damage caused by improper use or modifications to the instrument, or data that is lost or destroyed.

Always turn the power off when the instrument is not in use.

Even when the [] (Standby/On) switch is in standby status (display is off), electricity is still flowing to the instrument at the minimum level.

When you are not using the instrument for a long time, make sure you unplug the power cord from the wall AC outlet.

NOTICE

To avoid the possibility of malfunction/ damage to the product, damage to data, or damage to other property, follow the notices below.

■ Handling

- Do not use the instrument in the vicinity of a TV, radio, stereo equipment, mobile phone, or other electric devices. Otherwise, the instrument, TV, or radio may generate noise. When you use the instrument along with an application on your iPad, iPhone or iPod touch, we recommend that you set "Airplane Mode" to "ON" on that device in order to avoid noise caused by communication.
- Do not expose the instrument to excessive dust or vibrations, or extreme cold or heat (such as in direct sunlight, near a heater, or in a car during the day) to prevent the possibility of panel disfiguration, damage to the internal components or unstable operation.
- Do not place vinyl, plastic or rubber objects on the instrument, since this might discolor the panel or keyboard.
- When cleaning the instrument, use a soft and dry/slightly damp cloth. Do not use paint thinners, solvents, alcohol, cleaning fluids, or chemical-impregnated wiping cloths.

■ Saving data

• Edited Performance Data

Edited Performance data is lost when you turn off the power to the instrument without storing. This also occurs when the power is turned off by the Auto Power Off function (page 19).

• MIDI and System Settings

MIDI setting data and System setting data are automatically stored when those corresponding setting displays are switched to another display. Data is lost when you turn off the power to the instrument without switching displays. This also occurs when the power is turned off by the Auto Power Off function.

- Always save important data to the instrument, or to USB flash drive (page 60). Keep in mind, however, that data saved to the instrument may occasionally be lost due to some failure, an operation mistake, etc. For this reason, you should save your important data onto USB flash drive (page 60). Before using a USB flash drive, make sure to refer to page 61.

Information

■ About copyrights

- Copying of the commercially available musical data including but not limited to MIDI data and/or audio data is strictly prohibited except for your personal use.
- This product incorporates and bundles contents in which Yamaha owns copyrights or with respect to which Yamaha has license to use others' copyrights. Due to copyright laws and other relevant laws, you are NOT allowed to distribute media in which these contents are saved or recorded and remain virtually the same or very similar to those in the product.
 - * The contents described above include a computer program, Accompaniment Style data, MIDI data, WAVE data, voice recording data, a score, score data, etc.
 - * You are allowed to distribute medium in which your performance or music production using these contents is recorded, and the permission of Yamaha Corporation is not required in such cases.

■ About functions/data bundled with the instrument

- This device is capable of using various types/formats of music data by optimizing them to the proper format music data for use with the device in advance. As a result, this device may not play them back precisely as their producers or composers originally intended.

■ About this manual

- In this manual, MODX6+, MODX7+, and MODX8+ are collectively referred to as "MODX+."
- The illustrations and LCD screens as shown in this manual are for instructional purposes only, and may appear somewhat different from those on your instrument.
- Square brackets indicate on-screen buttons, connectors, and buttons from the control panel.
- Windows is a registered trademark of Microsoft® Corporation in the United States and other countries.
- Apple, macOS, Mac, iPhone, iPad, iPod touch and Logic are trademarks of Apple Inc., registered in the U.S. and other countries.
- Ableton is a trademark of Ableton AG.
- IOS is a trademark or registered trademark of Cisco in the U.S. and other countries and is used under license.
- The company names and product names in this manual are the trademarks or registered trademarks of their respective companies.

Yamaha may from time to time update firmware of the product without notice for improvement in functions and usability. To take full advantage of this instrument, we recommend that you upgrade your instrument to the latest version. The latest firmware can be downloaded from the website below:

<https://download.yamaha.com/>

After accessing the Support website (and clicking on "Firmware/Software"), enter the appropriate model name.

Information for users on collection and disposal of old equipment:



This symbol on the products, packaging, and/or accompanying documents means that used electrical and electronic products should not be mixed with general household waste.

For proper treatment, recovery and recycling of old products, please take them to applicable collection points, in accordance with your national legislation.

By disposing of these products correctly, you will help to save valuable resources and prevent any potential negative effects on human health and the environment which could otherwise arise from inappropriate waste handling.

For more information about collection and recycling of old products, please contact your local municipality, your waste disposal service or the point of sale where you purchased the items.

For business users in the European Union:

If you wish to discard electrical and electronic equipment, please contact your dealer or supplier for further information.

Information on Disposal in other Countries outside the European Union:

This symbol is only valid in the European Union. If you wish to discard these items, please contact your local authorities or dealer and ask for the correct method of disposal.

(58-M02 WEEE en 01)

A message from the MODX+ Development Team

Thank you for purchasing the Yamaha MODX+ Music Synthesizer. We have designed this instrument so that all of the amazing new ways of the sound expression made possible with the flagship synthesizer MONTAGE are made even more widely accessible to many players.

Sounds

The MODX+ is equipped with the Motion Control Synthesis engine, the same sound processing system installed on the MONTAGE. It provides high-definition AWM2 sounds, as well as dynamic FM-X sounds-and allows them to be controlled seamlessly and flawlessly with various controllers.

Also, the MODX+ has a new feature for instantly adding rhythm patterns so that the players can take their music creation forward with dynamic rhythm parts. With this feature, creating rhythmic changes in the “Motion Controls” is easier than ever!

Design

The MODX+ has been designed to be lightweight and portable, yet full-featured-with the Super knob, a large-sized color LCD and other controllers that allow the same operability and appearance as those of the MONTAGE. With the MODX+, you can take the MONTAGE sounds virtually anywhere for performing.

We really hope that the MODX+ will help your creativity and musical work grow by leaps and bounds.
Enjoy!

Sincerely,
The Yamaha MODX+ Development Team

Thank you for purchasing this Yamaha product.

This instrument is a synthesizer designed for use in both live performance and music production.

We recommend that you read this manual carefully so that you can fully take advantage of the advanced and convenient functions of the instrument.

We also recommend that you keep this manual in a safe and handy place for future reference.

About This Manual

Owner's Manual (this book)

Provides overall explanations of the basic functions of the instrument. Please use this Owner's Manual for an overview of the fundamental operations of the MODX+. If you need more detailed information or instructions on specific functions, use the Reference Manual described below.

PDF documentation

■ Reference Manual

Explains in detail about the internal structure and connection examples. Use this manual if you need more detailed information which is not covered in the Owner's Manual.

■ Synthesizer Parameter Manual

This general, cross-product document explains parameters, effect types, effect parameters, and MIDI messages that are used for all synthesizers. Read the Owner's Manual and Reference Manual first and then use this parameter manual if necessary to learn more about parameters and terms that relate to Yamaha synthesizers in general.

■ Data List

This contains various important lists such as the Performance List, Waveform List, Effect Type List, Arpeggio Type List, and MIDI Implementation Chart.

How to use the PDF manuals

The Reference Manual, the Synthesizer Parameter Manual, and the Data List are provided as data documents in PDF. The PDF manuals listed above can be obtained from the Yamaha Downloads web page. To do so, go to the web page using the following URL, select your country, select "Manual Library," and then enter "MODX+" into the "Model Name" field, and then click "Search."

Yamaha Downloads:

<https://download.yamaha.com/>

These PDF files can be viewed and read on a computer. When using Adobe® Reader® to view a PDF file, you can search for specific words, print a specific page or link to open a desired section in the manual. The term search and link functions are especially convenient methods of navigating through a PDF file, and we recommend that you use them. The latest version of Adobe Reader can be downloaded from the following URL.

<https://www.adobe.com/products/reader/>

Accessories

- AC adaptor
- Owner's Manual (this book)
- Cubase AI Download Information

Main Features

■ High-quality, enhanced sounds covering a wide range of music styles

The MODX+ has built-in AWM2 and FM-X tone generators which can be used alone or in combination.

- The AWM2 (Advanced Wave Memory) tone generator is loaded with a total of 5 GB (in 16-bit linear format) of preset sounds—the same size as that of MONTAGE. This means that the MODX+ has a huge variety of high-quality sounds, including highly realistic Piano sounds. The MODX+ features 1.75 GB of built-in User flash memory for storing various sound libraries, and the stored sounds can be used in the same way as presets.
- The FM-X tone generator provides a wide expressive range, giving you both standard FM and new-generation FM sounds.

→ Selecting Performances (page 22)

■ Extensive effect processing

The MODX+ has comprehensive effect systems giving you a wide array of signal processing options.

- Features independent effects for each part (max. 12 parts plus A/D part), including an Insertion Effect, three-band EQ before the Insertion effect, and two-band EQ after it. The Insertion Effect contains a wide variety of sound processing options, including a VCM (Virtual Circuit Modeling) effect and a special Vocoder effect.
- An overall Master Effect including multi-band compression, and five-band Master EQ.

→ Editing the Settings (page 37)

■ Motion Control System for new musical possibilities

The Motion Control System is a completely new feature for variably controlling Motions (rhythmical, multidimensional sound changes) in real time.

The Motion Control System has three main functions:

1) Super Knob:

For creating multi-dimensional sonic changes, and enhancing those changes with colorful, continually shifting lighting changes.

2) Motion Sequencer:

For continually variable sound changes.

3) Envelope Follower:

Synchronizes the Motions with tempo and volume of audio input and other Parts.

■ The Rhythm Pattern Function

The MODX+ has a powerful Rhythm Pattern function, with which you can dynamically create sounds using the Rhythm Parts. It allows you to assign Rhythm Parts instantly and create rhythmic changes in Motion Control using the Envelope Follower.

■ Expanded, enhanced Arpeggio function and Motion Sequence

The MODX+ enhances your musical expressiveness by combining the various Arpeggio types—more than 10,000—with the Motion Sequence function that creates dynamic sound variability over time. You can store all contents—Arpeggio Type, Motion Sequence, and other parameters such as Part volume—together as a “Scene,” and the stored Scenes are assigned to eight buttons, letting you conveniently and powerfully call up them as desired while you perform.

→ Playing the Keyboard (page 26)

■ Exceptionally convenient live performance functions

The MODX+ has a Live Set function for easily calling up Performances as you play on stage. Once you’ve stored Performances in the desired order, you can concentrate fully on your playing and never be at a loss on which to choose. The MODX+ also has SSS (Seamless Sound Switching) function^{*1} for switching between Performances smoothly without any notes being cut off.

*1: The SSS function is effective for Performances of up to four Parts.

→ Creating Your Own Live Sets (page 35)

■ Enhanced user interface

The enhanced user interface provides greater creative control and effective operation. Depending on the intended use, two different interface types are available: the touch panel for intuitive operations, or the switches for more secure and quick control. The switches light in three different ways, letting you instantly understand the current status of the switches.

■ Compact design with authentic, expressive keyboard

The MODX+ is compact in size and weight making it convenient for easy carrying. Despite its convenient portability, the MODX+ provides an authentic, natural keyboard that’s truly a pleasure to perform on: The MODX6+ has 61 keys and the MODX7+ features a semi-weighted keyboard of 76 keys, while the MODX8+ has 88 keys with a high-quality GHS keyboard.

■ Comprehensive system connectivity

The MODX+ features a built-in 4-channel in/10-channel out USB audio interface for recording the high-quality sound of the MODX+ (at 44.1 kHz sampling frequency) on a Mac or Windows PC—without the need for a separate device! The connections are also compatible with iOS devices.

Contents

PRECAUTIONS	2	Using as a Master Keyboard	49
A message from the MODX+ Development Team	6	Making settings for use as a master keyboard—Zone	49
About This Manual	7	Connecting a Microphone or Audio Equipment	50
Accessories	7	Playing the keyboard along with the sound input from the	
Main Features	8	A/D INPUT [L/MONO]/[R] jacks	50
Controls and Functions	10	Making Global System Settings	51
Top Panel	10	Setting automatic power-on tasks	51
Rear Panel	16	Setting button lamp behavior	51
Setting Up	18	Turning various functions on/off	51
Power Supply	18	Changing the Master Tuning	52
Connecting Speakers or Headphones	18	Changing the Velocity Curve	52
Powering Up the System	18	Changing the font size of the Live Set	53
Auto Power Off function	19	Connecting External MIDI Instruments	54
Restoring the initial factory settings (Initialize All Data)	19	Connecting to an external MIDI device with the MIDI [IN], [OUT]	
Basic Operation and Displays	20	terminals	54
Selecting Performances	22	Connecting to an external MIDI device with the [USB TO DEVICE]	
Selecting a Performance from the Live Set	23	terminal	54
Switching Performances	23	Using a Connected Computer	55
Using the Category Search function	24	Connecting to a computer	55
Playback Audition phrase	25	Creating a Song with a computer	57
Playing the Keyboard	26	Saving/Loading Data	60
Performance Play display	26	Saving the settings to a USB flash drive	60
Switching a Part on/off	27	Loading the settings from a USB flash drive	60
Using the Arpeggio function	28	Precautions when using the [USB TO DEVICE] terminal	61
Using the Motion Sequencer function	28	Using USB flash drives	61
Using controllers to change the sound	29	Shift Function List	62
Using the Knobs to change the sound	30	Display Messages	63
Using the Super Knob to change the sound	31	Troubleshooting	66
Mixing	33	Specifications	71
Using the Scene function	34	Index	73
Creating Your Own Live Sets	35		
Registering a Performance to a Live Set	35		
Sorting registered Performances in a Live Set	35		
Editing the Settings	37		
Performance Editing	37		
Part Editing	38		
Part Effect Editing	39		
How Parts are assigned to a Performance	40		
Creating a Performance by combining Parts	41		
Recording and Playback	45		
Terminology	45		
MIDI (Song) Recording	45		
Playing a Song	47		
Recording your performance as audio	48		
Playing an audio file	48		

Controls and Functions

Top Panel

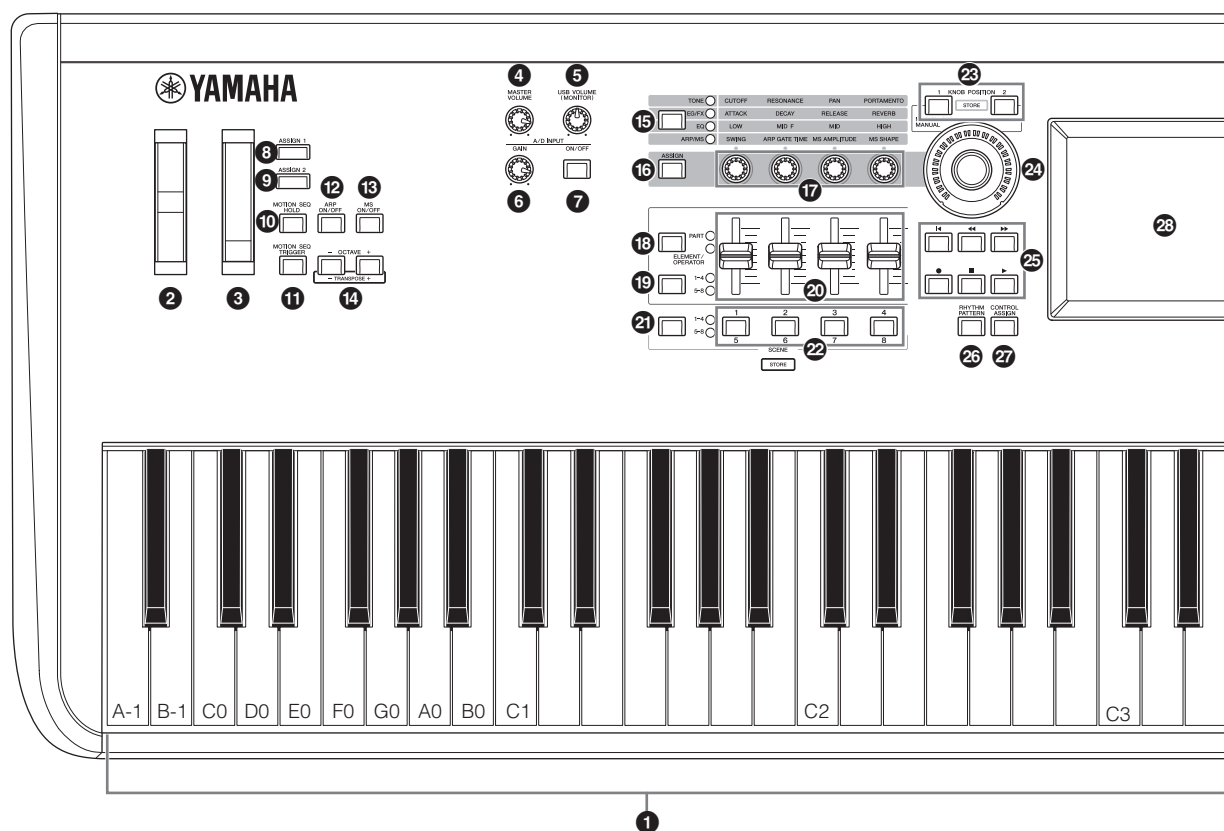

1 Keyboard

The MODX6+ features a 61-key keyboard, while the MODX7+ has 76 keys and the MODX8+ has 88 keys. With initial touch, the instrument senses how strongly or softly you play the keys, and uses that playing strength to alter the sound in various ways, depending on the selected Performance.

2 Pitch Bend wheel

Controls the pitch bend effect. You can also assign other functions to this controller.

3 Modulation wheel

Controls the modulation effect. You can also assign other functions to this controller.

4 [MASTER VOLUME] knob

Turn the knob clockwise or counterclockwise to control the output level from the OUTPUT [L/MONO]/[R] jacks and the [PHONES] jack.



CAUTION

Do not listen with the headphones at high volume for long periods of time. Doing so may cause hearing loss.

5 [USB VOLUME (MONITOR)] knob

Controls the volume of the audio input from the [USB TO HOST] jack to OUTPUT [L/MONO] and [R] jacks, and [PHONES] jack.

6 A/D INPUT [GAIN] knob (page 50)

Use this to adjust the input gain of the audio signals at the A/D INPUT [L/MONO]/[R] jacks. Turning the knob clockwise increases the gain level.

NOTE

You may need to change the setting depending on the input level of the external equipment connected to the A/D INPUT [L/MONO]/[R] jacks, in the following order: [UTILITY] → [Settings] → [Audio I/O] → [A/D Input]. When the output level of the connected equipment (such as a microphone, guitar or bass) is low, set this parameter to "Mic." When the output level of the connected equipment (such as a synthesizer keyboard or CD player) is high, set this parameter to "Line."

7 A/D INPUT [ON/OFF] button (page 50)

Switches whether or not this instrument accepts the audio signal input via the A/D INPUT [L/MONO]/[R] jacks. When A/D Input is enabled, the button lights; when disabled, it turns off.

The illustration shows the MODX8+, but the information applies to all models.

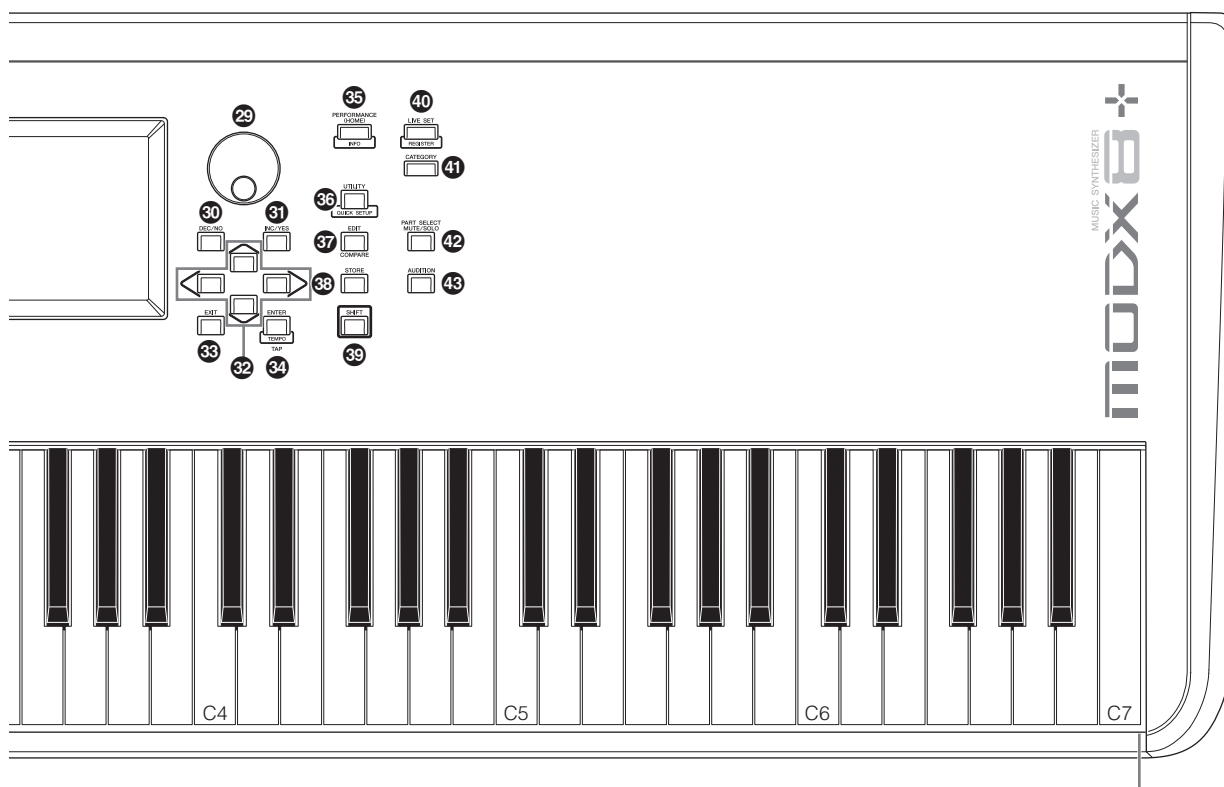

8 [ASSIGN 1] and 9 [ASSIGN 2] buttons (Assignable switches 1 and 2)

You can call up the specific Element/Operator of the selected Performance by pressing each of these buttons during your keyboard performance. In addition, you can assign other functions to these switches. When one of these effects is turned on, the corresponding button will light up and vice-versa.

10 [MOTION SEQ HOLD] (Motion Sequencer hold) button

Pressing this button while the Motion Sequencer is playing, results in the sound being held or frozen at the exact point in the sequence when the button was pressed. When the hold effect is turned on, the button lights.

11 [MOTION SEQ TRIGGER] (Motion Sequencer trigger) button

When the Trigger Receive parameter of the Motion Sequencer is set to ON, pressing this button starts Motion Sequence playback. The button lights fully when pressed.

12 [ARP ON/OFF] (Arpeggio on/off) button

Press this button to enable or disable playback of the Arpeggio. If the Arpeggio Switch of the selected Part is set to off, however, pressing this button has no effect. When Arpeggio is enabled, the button lights; when disabled, it turns off.

13 [MS ON/OFF] (Motion Sequencer on/off) button

Determines whether the Motion Sequencer is active or not. If the Motion Sequencer switch of the selected Part or Lane is set to off, however, pressing this button has no effect. When the Motion Sequencer is active, the button lights.

14 OCTAVE [-] and [+] buttons

Use these buttons to change the octave range of the keyboard. These buttons also function as Transpose [-] and [+] buttons. To lower or raise the pitch of the note in semitone steps, hold down the [SHIFT] button and press the corresponding [-]/[+] button. To restore the normal octave setting, press both buttons simultaneously. The buttons light or flash in different ways depending on the octave setting. For details, see the Reference Manual PDF document.

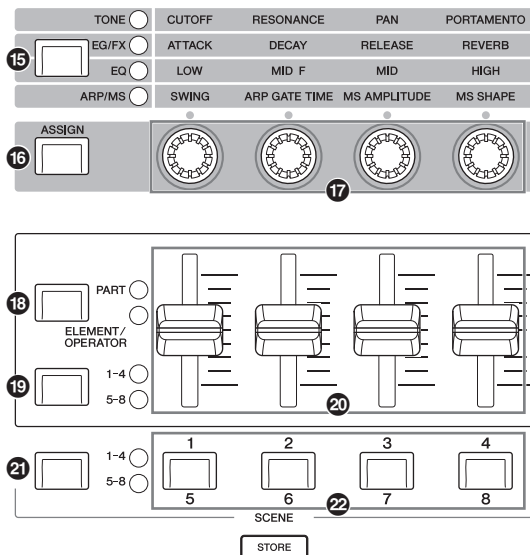

15 Knob Function [TONE]/[EG/FX]/[EQ]/[ARP/MS] button

Use this button to select functions to be assigned to Knobs. The lamp next to the currently active parameters will light. While the instrument is in the Performance Control status (page 30), the function is applied commonly to all Parts, while in the Part Control status (page 30), the function is applied to the selected Part. The lamp for the selected function will light.

16 [ASSIGN] button

Switches Knobs to function as Assign 1–4 or as Assign 5–8. While the instrument is in the Performance Control status (page 30), the function is applied commonly to all Parts, while in the Part Control status (page 30), the function is applied to the selected Part. The button lights when Assign 1–4 is selected, and the button flashes when Assign 5–8 is selected.

17 Knobs 1–4 (5–8)

These four highly versatile knobs on the panel let you adjust various important parameters, such as the current Part, Arpeggio tempo, and the Motion Sequencer. Pressing the Knob Function [TONE]/[EG/FX]/[EQ]/[ARP/MS] button on the upper left, or the [ASSIGN] button on the left changes the functions assigned to these knobs. These knobs function as Assignable Knobs when the [ASSIGN] button is lit or flashing.

18 Slider Function [PART]/[ELEMENT/OPERATOR] button

Sets four Control Sliders on the panel to use for controlling Parts or for controlling Elements. Each time you press this button, the slider function alternates between PART and ELEMENT/OPERATOR. The lamp for the selected function lights up.

19 Slider Select [1–4] [5–8] button

Selects four Control Sliders on the panel to use as 1–4 or 5–8. Each time you press this button, the setting alternates between 1–4 and 5–8. When the setting is 1–4 or 5–8, the lamp for the selected setting lights up. When you press the Slider Select button while holding down the [SHIFT] button, you can set the Control Sliders to function as 9–12 or 13–16. When the setting is 9–12 or 13–16, the lamp for the selected setting flashes.

20 Control Sliders 1–4 (5–8 / 9–12 / 13–16)

These sliders control the volume balance of the sound, by letting you adjust the individual levels of the 16 Parts (1–4 / 5–8 / 9–12 / 13–16), the eight Elements for Normal Parts (AWM2), the eight FM Operators for a Normal Part (FM-X), and eight Keys of the Drum Part, in different ways depending on the conditions of the various buttons.

NOTE

- If all of the Control Sliders are set to the minimum, you may not hear any sound from the instrument, even when playing the keyboard or a Song. If this is the case, raise all the sliders to a suitable level.
- The [MASTER VOLUME] knob controls the overall audio output level of this instrument. On the other hand, the Control Sliders control the level of each Element/Key/Operator of the Parts and the volume for each Part of the Performance as a parameter. Accordingly, the values set via the Control Sliders can be stored as Performance data.

21 Scene Select [1–4] [5–8] button

Selects four SCENE buttons on the panel to use as Scenes 1–4 or Scenes 5–8. Each time you press this button, the setting alternates between 1–4 and 5–8. The lamp for the selected function lights up.

22 SCENE [1/5] [2/6] [3/7] [4/8] buttons

You can assign different “snapshots” of important Part-related parameters such as track mute status and the basic Mixing setup to each of the SCENE buttons. You can switch these buttons to function as Scenes 1–4 or as Scenes 5–8 by pressing the Scene Select button.

When Scene-related parameters are edited and any of the SCENE [1/5]–[4/8] buttons is pressed while holding down the [SHIFT] button, the edit is stored for the currently selected [SCENE] button. The stored information is restored by pressing the selected button. The currently selected button fully lights, the button stored information lights dimly, and the button without stored information is turned off.

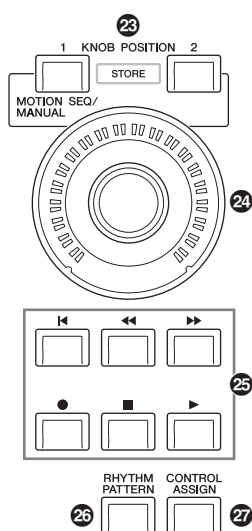

23 KNOB POSITION [1] and [2] buttons

Stores the parameter values of Assign 1–8. You can instantly switch between the two buttons.

Pressing the KNOB POSITION [1] button while holding down the [SHIFT] button, lets you store Value 1, and pressing the KNOB POSITION [2] button while holding down the [SHIFT] button, lets you store Value 2. Simultaneously pressing the KNOB POSITION [1] and [2] switches the Super Knob Motion Seq ON or OFF.

24 Super Knob

Simultaneously controls the parameters (Assign 1–8) assigned to the Knobs.

NOTE

You can also control the Super Knob by using the foot controller (FC7). For details, refer to page 33.

25 SEQ TRANSPORT button

These buttons control recording and playback of the Song sequence data.

[◀] (Top) button

Instantly returns to the beginning of the current Song (i.e., the first beat of the first measure).

[◀◀] (Reverse) button

Press briefly to move back one measure at a time.

[▶▶] (Forward) button

Press briefly to move forward one measure at a time.

[●] (Record) button

Press this to call up the Record setup display. (The button flashes.) Press the [▶] (Play) button to start recording. (The [●] (Record) button lights.)

[■] (Stop) button

Press to stop recording or playback. This button can also be used when you want to stop Arpeggio playback, even when Arpeggio is set to continue playback even after the note is released (Arpeggio hold switch is ON). You can also use this button to stop a Motion Sequence that receives Trigger signals.

[▶] (Play) button

Press to start playback or recording of a Song. During recording and playback, the button flashes at the current tempo.

26 [RHYTHM PATTERN] button

Use this button to call up the Rhythm Pattern display. You select the Rhythm Pattern you want to use, and then press [PERFORMANCE (HOME)] button or [EXIT] button to set the selection.

Pressing this button again cancels the selection and closes the Rhythm Pattern display.

27 [CONTROL ASSIGN] button

While the parameter assignable to controllers is selected on the display, press this button and operate the desired controller for assignment. The controller setting display appears.

28 Touch panel LCD

The LCD indicates the parameters and values related to the currently selected operation. You can operate by touching the display.

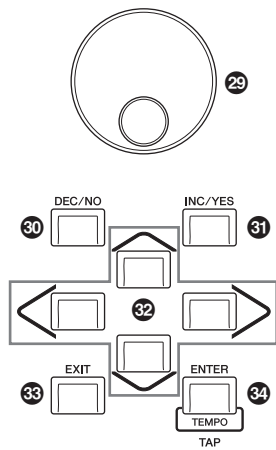

29 Data dial

For editing the currently selected parameter. To increase the value, turn the dial right (clockwise); to decrease the value, turn the dial left (counter-clockwise). If a parameter with a wide value range is selected, you can change the value in broader strokes by quickly turning the dial.

30 [DEC/NO] button

For decreasing the value of the currently selected parameter (DEC: decrement). This button can also be used to cancel a Job or Store operation.

Simultaneously hold down the [SHIFT] button and press the [DEC/NO] button to quickly decrease the parameter value in 10-step jumps.

31 [INC/YES] button

For increasing the value of the currently selected parameter (INC: increment). This button can also be used to execute a Job or Store operation.

Simultaneously hold down the [SHIFT] button and press the [INC/YES] button to quickly increase the parameter value in 10-step jumps.

32 Cursor buttons

The cursor buttons move the “cursor” around the display, highlighting and selecting the various parameters.

33 [EXIT] button

The menus and displays of the MODX+ are organized according to a hierarchical structure. Press this button to exit from the current display and return to the previous level in the hierarchy.

34 [ENTER] button

Use this button to call up the display of the selected menu, or to execute a Job or Store operation. Simultaneously hold down the [SHIFT] button and press the [ENTER] button to call up the Tempo Settings display.

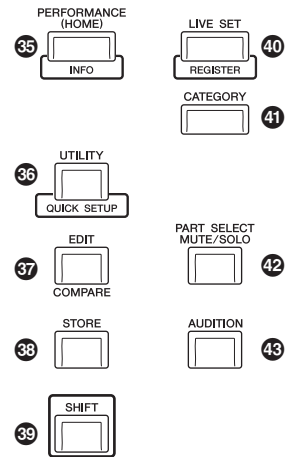

35 [PERFORMANCE (HOME)] button

Use this button to return to the Performance Play display. The button fully lights when the Performance Play display is shown. This button lights dimly when the Utility display is shown.

When the Performance Play display is shown and the cursor is on the Performance Name, pressing this button shows or hides the detailed information, which is the same information you can access by touching the [View] button on the Screen. Simultaneously hold down the [SHIFT] button and press the [PERFORMANCE (HOME)] button to call up the Overview display.

36 [UTILITY] button

Use this button to call up the Utility display for making overall system settings. The button fully lights when the Utility display is shown and the button lights dimly when other displays are shown.

Simultaneously hold down the [SHIFT] button and press the [UTILITY] button to call up the Quick Setup display. Pressing this button while holding down the [PART SELECT MUTE/SOLO] button opens the Touch Panel Calibration display.

37 [EDIT] button

Use this button to call up the display for editing Performances (page 22) and Live Sets (page 35). Also, pressing this button while editing Performance parameters lets you switch between the just-edited sound and its original, unedited condition, allowing you to hear how your edits affect the sound (Compare function). The button lights when the edit display is shown and the button flashes while Compare is active.

38 [STORE] button

Use this button to call up the Store display. The button fully lights when the Store display is shown and the button lights dimly when other displays are shown.

39 [SHIFT] button

Pressing this button along with another button enables you to execute various commands. For details, refer to the “Shift Function List” (page 62).

40 [LIVE SET] button

Use this button to store all your favorite, often-used Performances in a single, easy-to-access location and call them up.

Simultaneously hold down the [SHIFT] button and press the [LIVE SET] button to call up the Live Set display for storing the currently selected Performance to the Live Set. This is one more useful way you can quickly switch among Performances you need in live performance situations.

The button fully lights when the Live Set display is shown. If the Live Set display is not shown, the button lights dimly when the Live Set function is active and the button's lamp is off when the function is NOT active.

41 [CATEGORY] button

The Category Search function (page 24) can be accessed by using this button.

Use this button while the Performance Play display is shown to call up the Performance Category Search display for selecting the entire Performance. When the cursor is on the Part name in the Performance Play display, simultaneously hold down the [SHIFT] button and press the [CATEGORY] button to call up the Part Category Search display, allowing you to select a sound type for the currently selected Part. The button fully lights when the Category Search display is shown. If the Category Search display is not shown, the button lights dimly when the Category Search function is active and the button's lamp is off when the function is NOT active.

42 [PART SELECT MUTE/SOLO] button

Use this button to select a Part or to turn Mute or Solo ON or OFF. Pressing this button while in the Performance Play display opens the Part Select window.

Button	Operations
1-8	Shows Parts 1-8
9-16	Shows Parts 9-16
Select	Switches to the Part Selection display
Mute	Switches to the Mute Setting display
Solo	Switches to the Solo Setting display

The letter "M" is shown for the Muted Part, and the letter "S" is shown for the Soloed Part.

To close the Part Select window, press the button again or touch the "x" mark on the Screen.

The button lights up fully while the Part Select window is shown on the screen, and the button lights dimly when the Part Select window is not shown. The button is turned off in the Utility display or Live Set display, or any other displays that do not require Part Select.

43 [AUDITION] button

Use this button (in the Performance Play, Live Set, or Category Search displays) to play back or stop a sample phrase showcasing the selected Performance sound. This sample phrase of the Performance is called the "Audition phrase." The button fully lights when it is ON and the button lights dimly when the Audition function is active such as in the Category Search display.

This button also lets you lock/unlock the panel control to prevent accidental or unwanted operations during performance. To use this function, hold down the [SHIFT] button and press this button simultaneously, while the Performance Play display or the Live Set display is shown.

NOTE

While panel control is locked, only certain operations (keyboard, pedals, MASTER VOLUME, Super knob, Pitch Bend wheel, panel unlock) are possible. All other operations, including touch panel operations, are disabled.

Rear Panel

Left side of Rear Panel

The illustration shows the MODX8+, but the information applies to all models.

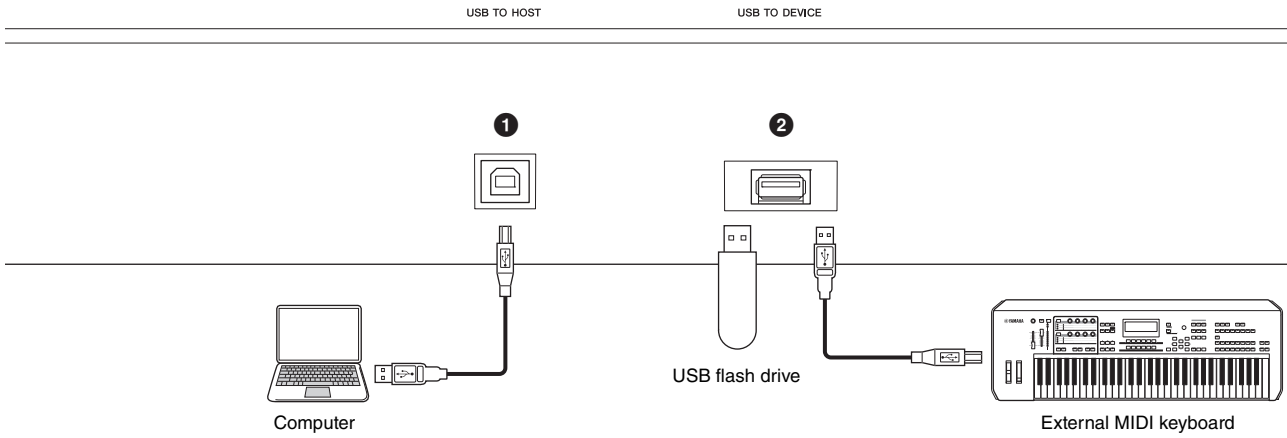

Right side of Rear Panel

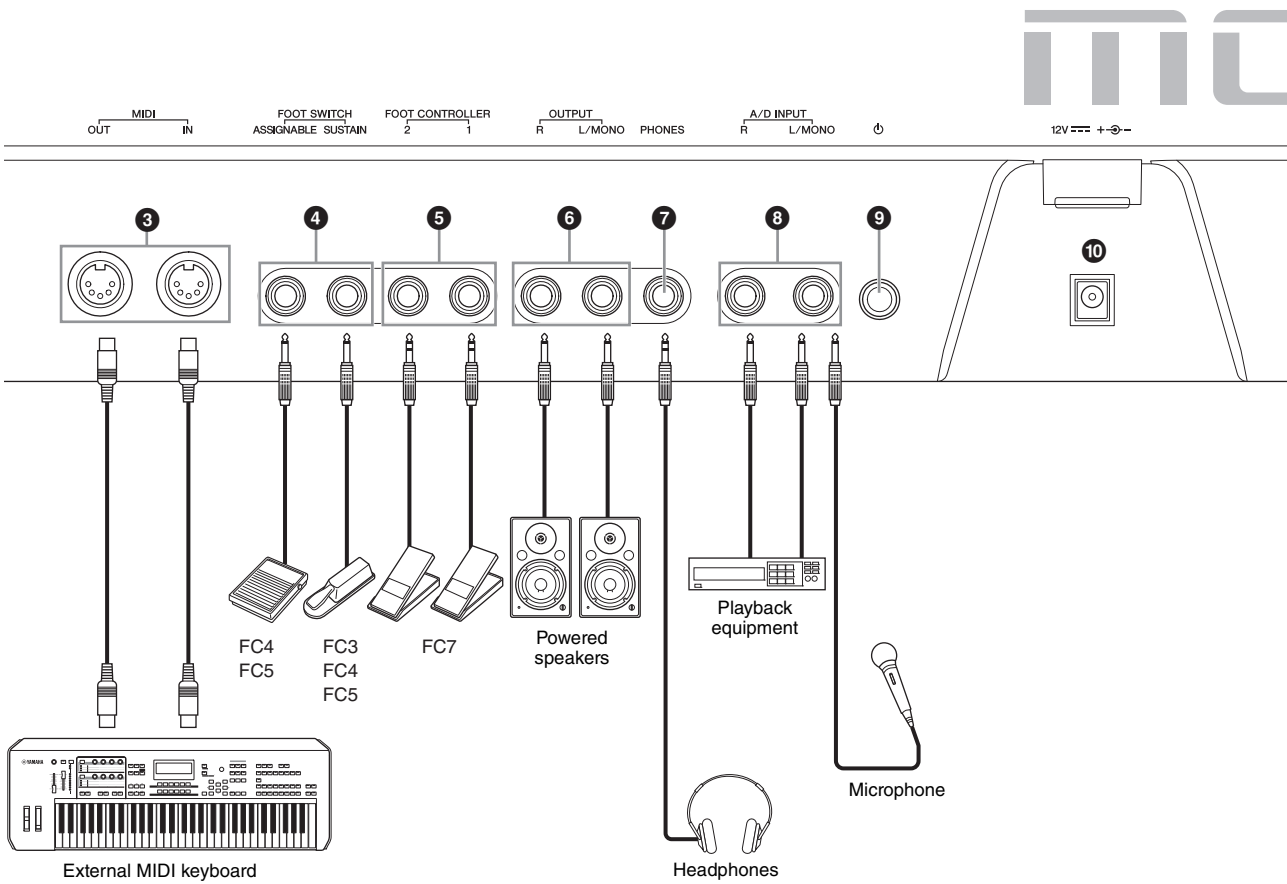

■ Left side of Rear Panel

❶ [USB TO HOST] terminal

Used to connect this instrument to a computer via a USB cable, and allows you to transfer MIDI data and audio data between the devices. Unlike MIDI, USB can handle multiple ports via a single cable (page 56). For information about how the MODX+ handles Ports, see page 56.

NOTE

Audio data sending capability for this instrument is a maximum 10 channels (5 stereo channels). Audio data receiving capability is a maximum 4 channels (2 stereo channels).

❷ [USB TO DEVICE] terminal

Used to connect this instrument to a USB flash drive (page 61), or an external MIDI device (page 54). Connecting a USB flash drive lets you save data created on this instrument to the drive and load data from the drive to the instrument. Save/Load operations can be performed: [UTILITY] → [Contents] → [Store/Save] or [Load].

NOTE

- No other USB devices (such as a hard disk drive, CD-ROM drive and USB hub) can be used.
- The instrument supports the USB 1.1 to 3.0 standard. However, note that the transfer speed differs depending on the data type and the condition of this instrument.

■ Right side of Rear Panel

❸ MIDI [IN], [OUT] terminals

MIDI [IN] is for receiving control or performance data from another MIDI device, such as an external sequencer, letting you control this instrument from the connected separate MIDI device.

MIDI [OUT] is for transmitting all control, performance and playback data from this instrument to another MIDI device, such as an external sequencer.

When the "MIDI IN/OUT" setting (page 54) is "USB," these terminals can be used for connecting an external MIDI device to your computer (page 56).

❹ FOOT SWITCH [ASSIGNABLE]/[SUSTAIN] jacks

For connection of a separately sold FC3/FC4/FC5 Footswitch to the [SUSTAIN] jack and a FC4/FC5 Footswitch to the [ASSIGNABLE] jack. When connected to the [SUSTAIN] jack, the Footswitch controls sustain. When connected to [ASSIGNABLE], it can control one of various assignable functions.

NOTE

- The term "FC3" in this Owner's Manual refers collectively to the FC3 and other footswitches compatible with the FC3, such as the FC3A.
- The term "FC4" in this Owner's Manual refers collectively to the FC4 and other footswitches compatible with the FC4, such as the FC4A.

❺ FOOT CONTROLLER [1]/[2] jacks

For connection of a separately sold foot controller (FC7, etc.). This jack lets you continuously control one of various different assignable functions for Part edit—such as volume, tone, pitch, or other aspects of the sound (see the Reference Manual PDF document).

❻ OUTPUT [L/MONO] and [R] jacks

Line level audio signals are output via these standard phone jacks. For monophonic output, use only the [L/MONO] jack.

❼ [PHONES] (Headphone) jack

This standard stereo phones jack is for connection to a set of stereo headphones. This jack outputs audio signals identical to those from the OUTPUT [L/MONO] and [R] jacks.

❽ A/D INPUT [L/MONO]/[R] jacks

External audio signals can be input via these phone jacks (1/4" mono phone plug). Various devices such as a microphone, CD player or synthesizer can be connected to these jacks and their audio input signal can be sounded as the Audio Part.

In addition, you can use the special Vocoder feature by connecting a microphone to this [L/MONO] jack and inputting your voice to the microphone.

You can also use the Envelope Follower and ABS (Audio Beat Sync) features. Envelope Follower is a function for detecting the volume envelope of the input signal waveform and modifying sounds dynamically.

NOTE

- A guitar or bass having active pickups can be directly connected. However, when using passive pickups, connect the instrument via an effect device.
- The Vocoder/Envelope Follower can be controlled from all Part outputs, and not just the A/D INPUT [L/MONO]/[R] jacks.

ABS (Audio Beat Sync) is a function for detecting the beat of the audio signal input from these jacks and synchronizing the beat with the Motion Sequencer or Arpeggio. Use 1/4" mono phone plugs. For stereo signals (such as from audio equipment), use the [L/MONO]/[R] jacks. For mono signals (such as from a microphone or guitar), use only the [L/MONO] jack.

For details about the Envelope Follower and ABS features, see the Reference Manual PDF document.

❾ [⏻] (Standby/On) switch

Press to set the power to On or Standby.

❿ [DC IN]

Plug the AC adaptor supplied with this instrument.

Setting Up

Power Supply

Connect the supplied AC adaptor in the following order.

- 1 Make sure the [⏻] (Standby/On) switch on the instrument is set to the Standby (■) position.
- 2 Wrap the DC output cable of the AC adaptor around the cable clip (as shown below), and then connect the plug of the adaptor to the DC IN jack on the rear panel.

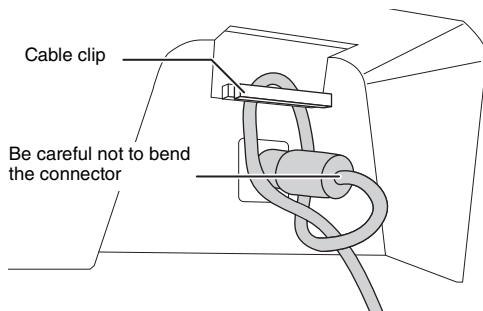

NOTE

Use of the cable clip prevents accidental unplugging of the cable during operation. Make sure to avoid tightening the cord more than necessary or pulling on the cord strongly while it is wrapped around the cable clip to prevent wear on the cord or possible breakage of the clip.

- 3 Connect the other end of the AC adaptor to an AC outlet.

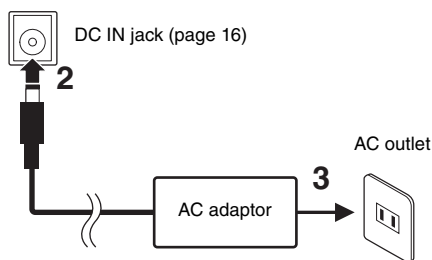

NOTE

Reverse the order of the instruction steps above when disconnecting the AC adaptor.



WARNING

- Use the specified AC adaptor (page 71) only. Using the wrong AC adaptor can result in damage to the instrument or overheating.
- When using the AC adaptor with a removable plug, make sure to keep the plug attached to the AC adaptor. Using the plug alone can cause electric shock or fire.
- Never touch the metallic section when attaching the plug. To avoid electric shock, short circuit or damage to avoid electric shock, short circuit or damage. Also, be careful that there is no dust between the AC adaptor and plug.

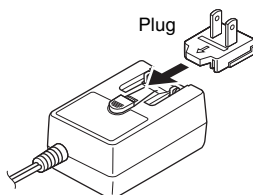

The shape of the plug differs depending on your area.



CAUTION

- When setting up the product, make sure that the AC outlet you are using is easily accessible. If some trouble or malfunction occurs, immediately turn the power off and disconnect the plug from the outlet.
- The instrument remains charged and draws a small amount of power even when the [⏻] (Standby/On) is set to the Standby position. For this reason, if you intend not to use it for an extended period of time, make sure to unplug the power cord from the wall outlet.

Connecting Speakers or Headphones

Since the instrument has no built-in speakers, you will need to monitor the sound of the instrument by using external equipment. Connect a set of headphones, powered speakers, or other playback equipment as illustrated below. When making connections, be sure that your cables have the appropriate ratings.

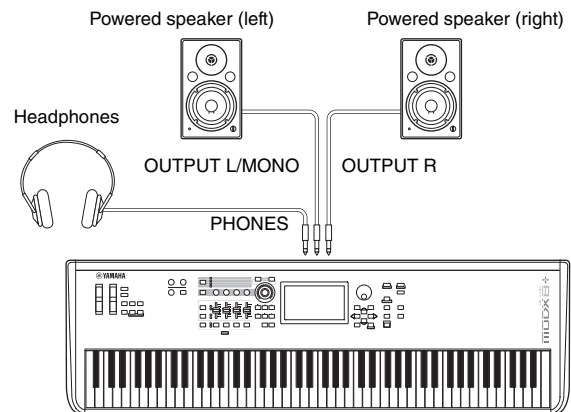

Powering Up the System

Make sure the volume settings of the instrument and external devices such as powered speakers are turned to the minimum before turning the power on. When connecting the instrument to powered speakers, turn on the power switch of each device in the following order.

When turning the power on:

First, the instrument (the display will turn on and the buttons will light), then the connected powered speakers.

When turning the power off:

First, the connected powered speakers, then the instrument (the display will turn off and the buttons will turn off).

Keep in mind that the [⏻] (Standby/On) switch is located at the left side (from the view of the keyboard) of the DC IN socket on the rear panel of the instrument.

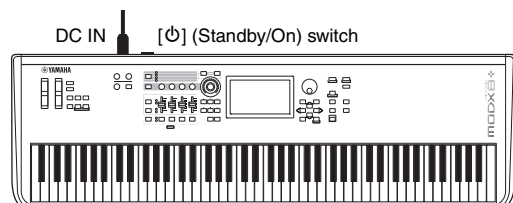

Auto Power Off function

To prevent unnecessary power consumption, this instrument features an Auto Power Off function that automatically turns the power off if the instrument is not operated for a specified period of time.

Auto Power Off Setting

The amount of time that elapses before the power is automatically turned off can be set.

Instructions:	[UTILITY] → [Settings] → [System] → [Auto Power Off]
Setting Value (min.):	off (disables Auto Power Off), 5, 10, 15, 30, 60, 120
Default Setting (min.):	off

Disabling Auto Power Off (simple method)

Turn the power on while holding down the lowest key on the keyboard. An “Auto power off disabled” message appears briefly and Auto Power Off is disabled. The setting is retained even if the power is turned off.

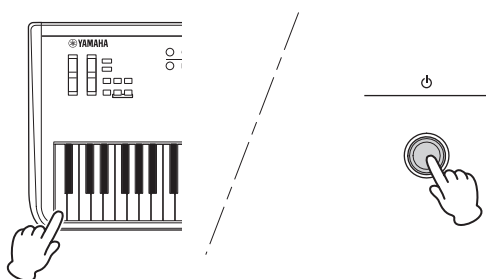

NOTICE

- Even when the power is turned off, electricity is still flowing to the instrument at the minimum level. To shut off the electricity completely, make sure you unplug the power cord from the wall AC outlet.
- Depending on the instrument status, the power may not turn off automatically, even after the elapse of the specified period of time. Always turn off the power manually when the instrument is not in use.
- When the instrument is not operated for a specified period of time while connected to an external device such as an amplifier, speaker or computer, make sure to follow the instructions in the Owner's Manual to turn off the power to the instrument and the connected devices in the proper sequence, in order to protect the devices from damage. If you do not want the power to turn off automatically when a device is connected, disable Auto Power Off.
- The setting will revert to its default value if not backed up before the power is turned off.
- When Auto Power Off is set to “off,” the value will be retained even if the backup data saved on another device is loaded to the instrument. When Auto Power Off is set to something other than “off,” the value will be overwritten with loaded data.

NOTE

- The setting time is approximate.
- To turn the power on after Auto Power Off has been executed, press the [⏻] (Standby/On) switch to set the switch to the Standby (■) position and press it again to turn ON.
- When the factory settings are restored, the setting is changed to the default value (off).

Restoring the initial factory settings (Initialize All Data)

NOTICE

When the Initialize All Data operation is executed, all the Performance, Song, and any system settings you created on the Utility display will be erased. Make sure you are not overwriting any important data. Be sure to save all important data to your USB flash drive before executing this procedure (page 60).

- 1 Press the [UTILITY] button or touch the UTILITY icon in the upper right of the screen to call up the Utility display.
- 2 Touch the [Settings] tab in the left of the screen and then touch the [System] tab.
The entire system setting display appears.
- 3 Touch [Initialize All Data] in the lower right of the screen.
The display prompts you for confirmation. To cancel this operation, touch the [Cancel No] in the screen or press the [DEC/NO] button on the panel.
- 4 Touch [Yes] in the screen or press the [INC/YES] button to execute the Initialize All Data operation.

Basic Operation and Displays

The MODX+ features a convenient touch panel display. You can operate various settings and select desired parameters by directly touching the screen. Furthermore, you can use the data dial and other buttons for display operations.

Display (touch panel) configuration

This section explains the navigation bar and the display selecting tabs which are common to all types of displays. For the purpose of illustration, the Live Set display which MODX+ appears when the MODX+ is turned on and the Performance Play display (Home display) are used as examples.

NOTE

You can change the start-up display (the display that first appears when the power is turned on). For details about the setting, see page 51.

Live Set display



1 HOME icon

Moves to the Performance Play display.

2 EXIT icon

Functions same as the [EXIT] button on the panel. Press this icon to exit from the current display and return to the previous level in the hierarchy.

3 INFORMATION area

Displays helpful information, including the currently selected display name.

4 EFFECT icon

Touch the icon to call up the Effect switch display. The icon turns off when any of the Effect blocks (Insertion, System or Master) is off.

5 QUICK SETUP icon

Displays the settings of Local Control ON/OFF and MIDI IN/OUT.

The keyboard-shaped icon lights up when Local Control is set to ON and turns off when Local Control is set to OFF.

When MIDI is set as the MIDI IN/OUT setting, a MIDI connector-shaped icon appears. When USB is set as the MIDI IN/OUT setting, a USB connector-shaped icon appears.

Touch the desired icon to call up the corresponding quick setup display.

6 TEMPO SETTINGS icon

Displays the tempo of the currently selected Performance. Touch the icon to call up the Tempo settings display.

7 UTILITY icon

Touch the icon to call up the last opened display among the Utility displays.

Performance Play display (Home display)



8 LIVE SET icon

Touch the icon to call up the Live Set display.

9 Display selecting tabs

Touch the desired tab to call up the corresponding display.

10 View button

Determines whether the detailed information of each Part is displayed (On) or not displayed (Off). The displayed information differs depending on the cursor position or the Slider function settings.

Moving the cursor

Use these four buttons to navigate the display, moving the cursor around the various selectable items and parameters in the screen. When selected, the relevant item is highlighted (the cursor appears as a dark block with inverse characters). You can change the value of the item (parameter) at which the cursor is located by using the data dial, [INC/YES] and [DEC/NO] buttons.

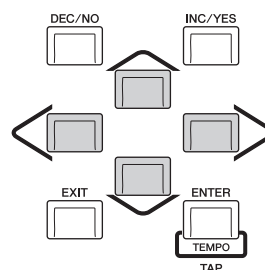

Changing (editing) parameter values

Rotating the Data dial to the right (clockwise) increases the value, while rotating it to the left (counter-clockwise) decreases it.

Pressing the [INC/YES] button increases a parameter value by one step, and pressing [DEC/NO] button decreases it. For parameters with large value ranges, you can increase the value by 10 by simultaneously holding down the [SHIFT] button and pressing the [INC/YES] button. To decrease by 10, simultaneously hold down the [SHIFT] button and press the [DEC/NO] button.

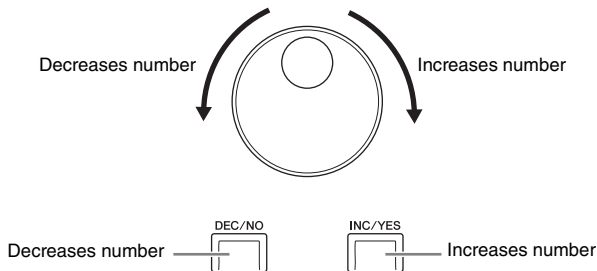

Naming (inputting characters)

You can freely name the data you've created, such as Performances, Songs, and files saved to a USB storage device. Touch the Naming parameter or move the cursor to the Naming parameter and press the [ENTER] button to call up the input character display.

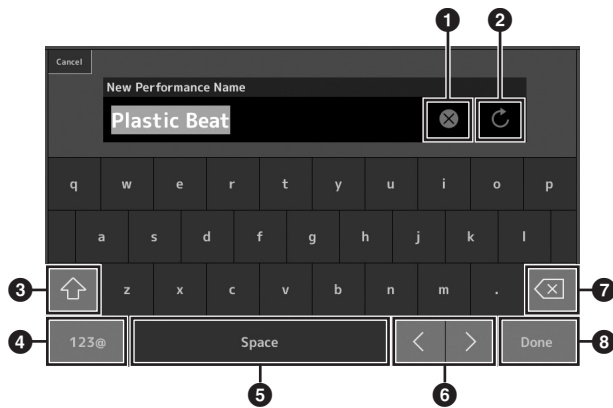

- 1 Deletes all characters.
- 2 Reverts to the default name.
- 3 Switches between uppercase and lowercase alphabetical characters.
- 4 Calls up the display for entering numbers, punctuation marks and miscellaneous characters.
- 5 Inserts a space (blank) at the cursor position. (You can also use the [INC/YES] button for the same operation.)
- 6 Moves the cursor position.
- 7 Deletes the previous character (backspace). (You can also use the [DEC/NO] button for the same operation.)
- 8 Completes the text input and closes the display.

Inputting using the keys on the keyboard and numeric keypad display

For some parameters, you can also enter the value directly, using the LCD as a numeric keypad or using keys on the keyboard. Input via the keys is activated for the parameters where the numerical values should be entered. Input via the numeric keypad display is activated when inputting values. Touch the desired parameter or move the cursor to the parameter and press the [ENTER] button to call up the display having the two menus (shown below).

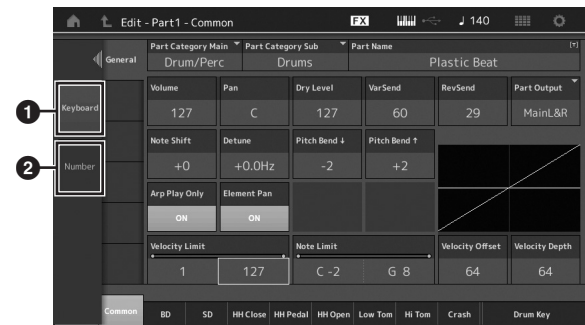

- 1 Enables keyboard input.
You can play any note on the keyboard and the note or velocity are input.
- 2 Enables numeric keypad input.
You can input a number directly by using the numeric keypad. You can also use the data dial, the [INC/YES] button, and the [DEC/NO] button to increase and decrease the input number.

Numeric keypad display

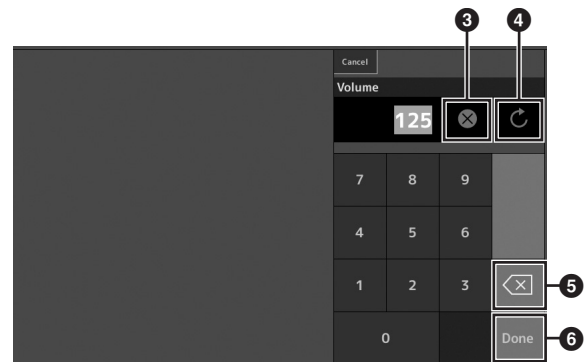

- 3 Erases all numbers.
- 4 Restores the value to the last setting.
- 5 Deletes the last digit of the number.
- 6 Completes the input operation and closes the numeric keypad display.

Selecting Performances

The MODX+ has 16 Parts and basic musical instrument sounds are assigned to each Part. A single set of these sounds is called a "Performance." You can change sounds as desired by selecting the appropriate Performance.

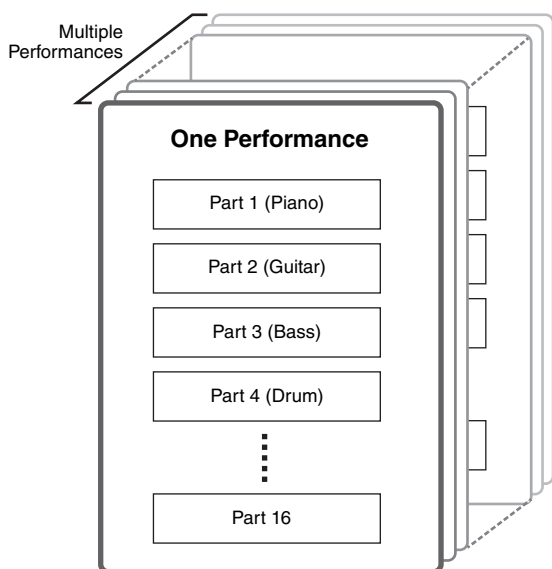

There are three Part types as follows.

Normal Parts (AWM2)

Normal Parts (AWM2) are mainly pitched musical instrument type sounds (piano, organ, guitar, synthesizer, etc.) that can be played over the full range of the keyboard.

Normal Parts (FM-X)

Normal Parts (FM-X) are powerful FM Synthesis system sounds. This sound is played conventionally from the keyboard, with standard pitches sounding for each key.

Drum Parts

Drum Parts are mainly percussion/drum sounds that are assigned to individual notes.

Performances can also be divided into two groups as follows.

Single Part Performances

A Single Part Performance contains only one Part. Select this if you want to play a single instrument.

Multi Part Performances

A Multi Part Performance contains multiple Parts. Select this if you want to play sounds of multiple instruments by using layering and splitting functions.

This instrument features Banks for memorizing Performances. There are basically four different types of Banks: Preset, User, Library, and GM. The contained Performances and features depend on the Bank as described below.

Preset Banks

The Preset Banks contain a full set of specially programmed Performances. Performances you've edited yourself cannot be saved in the Preset Banks.

User Banks

The User Banks contain the Performances you have edited and stored. The User Banks are initially empty.

NOTICE

If a Performance in a User Bank (User Performance) is overwritten or replaced, that User Performance will be lost. When you store an edited Performance, be careful not to overwrite any important User Performances.

Library Banks

The Library Banks contain the Performances you have added as Libraries. The Library Banks are initially empty. (A Library can be added by importing a library file.)

GM Bank

The GM Bank contains the Parts allocated according to the GM standard.

GM

GM (General MIDI) is a worldwide standard for Voice organization and MIDI functions of synthesizers and tone generators. It was designed primarily to ensure that any song data created with a specific GM device would sound virtually the same on any other GM device—no matter the manufacturer or the model. The GM bank on this synthesizer is designed to appropriately play back GM song data. However, keep in mind that the sound may not be exactly the same as played by the original tone generator.

Each of these Banks include Performances organized according to the Performance type.

NOTE

- For details about Performances, refer to "Basic Structure" in the Reference Manual PDF document.
- For lists of the Performances, refer to the separate Data List PDF.

When you turn on your instrument for the first time, a Live Set of the Preset Banks will be displayed in the top display. The Live Set is a list in which Performances can be freely arranged. Up to 16 Performances can be arranged over a single page. You can play various Performances selected from the Preset Live Sets.

Selecting a Performance from the Live Set

1 Press the [LIVE SET] button.

This calls up the Live Set display.

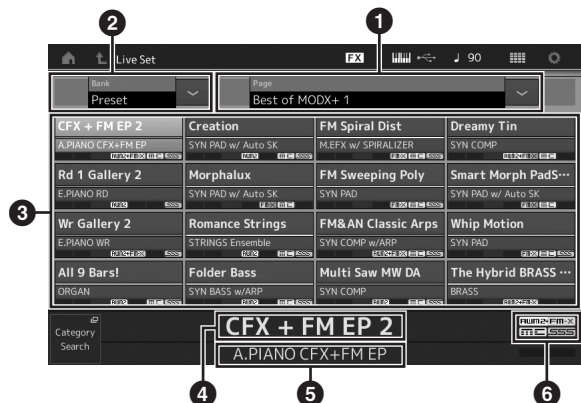

1 Page (switched by pressing [Λ] [V] in the screen)

NOTE

You can also use [SHIFT] and [INC/DEC] or [SHIFT] and [DEC/NO] for switching pages.

2 Preset Set Bank/User Bank (switched by pressing the [Λ] [V] in the screen)

3 Performance list

4 Active Performance names

5 Slot name

6 Flag (see chart below)

Flag	Definition
AWM2	Performance comprised only of AWM2 Parts
FM-X	Performance comprised only of FM-X Parts
AWM2+FM-X	Performance comprised of both AWM2 and FM-X Parts
MC	Performance featuring Motion Control
SSS	Performance featuring Seamless Sound Switching

NOTE

- “Seamless Sound Switching” is a feature that lets you switch Performances smoothly without any notes being cut off. The SSS feature is available for all Preset Bank Performances in this instrument. However, SSS is available only for the Performance containing Parts 1–4, not for the Performance with using Parts 5–16.
- When the background of “FM-X” flag display is a gradient, it indicates that the Performance has the Smart Morph information. The Smart Morph is a function that allows you to smoothly morph the FM-X sound between multiple FM-X sounds, using machine learning. For details, refer to the Reference Manual.

2 Touch the desired Performance on the screen.

NOTE

To rearrange the order of the Performances registered in the Live Set, see page 35.

3 Play the keyboard.

Switching Performances

1 Press the [PERFORMANCE (HOME)] button.

The Performance Play display appears, and the current Performance name is shown.



2 Move the cursor to the Performance name and select the desired Performance by using the data dial, the [INC/YES] button, or the [DEC/NO] button.

NOTE

- To quickly move forward through the Performance numbers in 10-step jumps, simultaneously hold down the [SHIFT] button and press the [INC/YES] button.
- To decrease by 10, do the opposite; simultaneously hold down the [SHIFT] button and press the [DEC/NO] button.

3 Play the keyboard.

Using the Category Search function

The Performances are conveniently divided into specific Categories, irrespective of their bank locations. The categories are divided based on the general instrument type or sound characteristics. The Category Search function gives you quick access to the sounds you want.

1 Press the [CATEGORY] button while the Performance Play display is shown.

This calls up the Category Search display.

NOTE

You can open the Category Search display by selecting [Category Search] from the menu that is called up when the Performance name is touched.

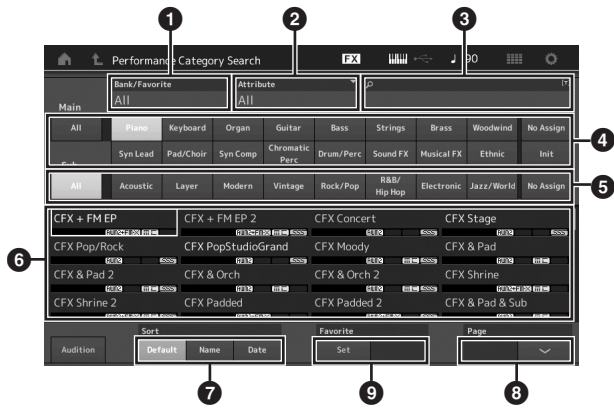

- 1 Bank
- 2 Attribute
- 3 Keyword search
- 4 Main categories
- 5 Sub categories
- 6 Performance list of the selected category

NOTE

The selected Performance is displayed in white, Performances with a single part are in green, and Performances with multi parts are in blue.

- 7 For changing the sorting order
- 8 For changing the Performance list page
- 9 Adding to or deleting from the Favorite List

2 Touch and select the desired main category (4).

NOTE

- You can filter the Performance lists by touching [Bank] (1) and selecting the desired bank type from the list.
- You can also filter the Performance lists by touching [Attribute] (2) and selecting the desired attribute type from the list.
- You can also call up your own favorite Performances instantly. To enable this, touch [Set] (9) on the screen and bookmark your favorite Performances beforehand.

3 Touch and select the desired sub category (5).

This calls up the Performance lists of the selected category (6).

4 Touch the desired Performance.

5 Touch the HOME icon or EXIT icon to actually call up the selected Performance.

This closes the Category Search display.

NOTE

You can also use the [ENTER] button, the [EXIT] button, or the [PERFORMANCE (HOME)] button to finalize the selection.

Below is a list of the Categories and their panel abbreviations.

Abbreviation	Category
Piano	Piano
Keyboard	Keyboard instruments (Harpsichord, Clav, etc.)
Organ	Organ
Guitar	Guitar
Bass	Bass
Strings	Strings
Brass	Brass
Woodwind	Woodwind instruments
Syn Lead	Synth Lead
Pad/Choir	Synth Pad
Syn Comp	Synth Comp
Chromatic Perc	Chromatic Percussion (Marimba, Glockenspiel, etc.)
Drum/Perc	Drum/Percussion
Sound FX	Sound Effect
Musical FX	Musical Effect
Ethnic	Ethnic
No Assign	No Assign
Init	Initialize

6 Play the keyboard.

Selecting an Initialized Performance

Follow the steps below to select an Initialized Performance.

- 1 Touch [Init] of the main category in the Category Search display.
- 2 Only initialized Performances are displayed in the Performance list.

The Initialized Performances are divided into three categories: [Init Normal (AWM2)] for the normal Parts (AWM2), [Init Normal (FM-X)] for the normal Parts (FM-X), and [Init Drum] for the Drum Parts.

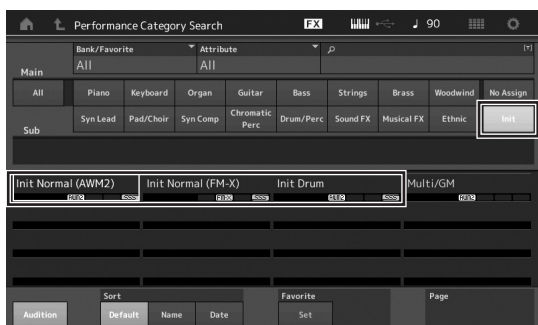

- 3 Select the desired Performance.

Selecting only Single Part Performances

You can filter out the Single Part Performances by using the Attribute function.

- 1 Touch [Attribute] in the Category Search display.
- 2 Touch [Single] from the menu in the left of the screen.

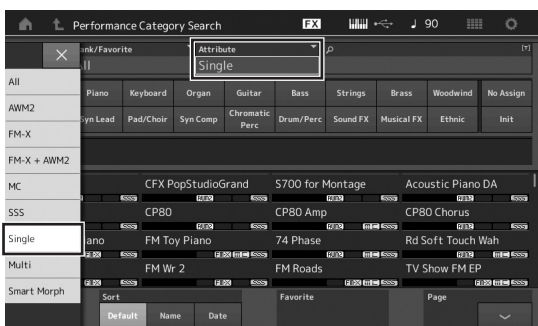

- 3 Only Single Part Performances are displayed in the Performance list, letting you select the desired one.

Playback Audition phrase

You can hear a sample of Performance sounds. The sample sound is referred to as "Audition phrase."

- 1 Touch [Audition] in the Category Search display.

The sample of the currently selected Performance plays.

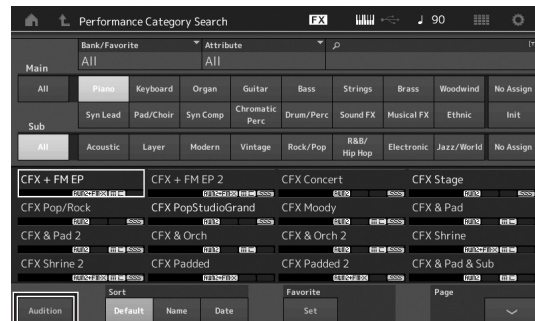

[Audition]

If you select a different Performance during Audition phrase playback, the audition phrase switches to that of the newly selected Performance.

- 2 Touch [Audition] again to stop playback.

NOTE

- You can also playback/stop the Audition phrase by pressing the [AUDITION] button on the front panel.
- You can playback/stop the Audition phrase by pressing the [AUDITION] button on the front panel while the Performance display or the Live Set display is shown.

Playing the Keyboard

You can mix several different parts together in a layer, or split them across the keyboard, or even set up a combination layer/split. Each Performance can contain up to eight different Parts. Press the [PERFORMANCE (HOME)] button before playing the keyboard.

Performance Play display

In this condition, playing the keyboard sounds the Performance indicated in the display. The parameters shown in the Performance Play display are briefly explained below. You can operate the icons by touching on the display.



- ❶ Performance name
- ❷ Flag
- ❸ Functions assigned to knobs
- ❹ Part names
- ❺ Switching Motion Sequencer on/off for Parts
- ❻ Switching Arpeggio on/off for Parts
- ❼ Note Limit for Parts
- ❽ Switching Keyboard Control on/off for Parts
- ❾ Switching Mute on/off for Parts
- ❿ Switching Solo on/off for Parts
- ⓫ Volume of Parts 1–8
- ⓬ Meter (Audio Output Level)
- ⓭ Showing or hiding detailed information on each Part

Switching a Part on/off

You can turn the eight Parts of the current Performance on or off as desired.

Turning specific Parts on/off (Mute function)

You can turn individual Parts on/off by using the Mute function.

1 Press the [PERFORMANCE (HOME)] button.

The button lamp lights, indicating that each Part can be turned on/off.

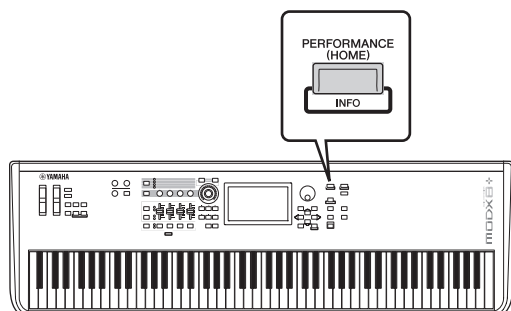

2 Touch the [MUTE] button on the screen to mute the Part.

Touch the same button again to turn the button off and disengage the mute function for that Part. You can turn multiple Parts on/off by touching their buttons.

You can also mute parts by using the [PART SELECT MUTE/SOLO] button with the operation below.

1 While the Performance display is shown, press the [PART SELECT MUTE/SOLO] button.

The Part Select Windows appears on the display.

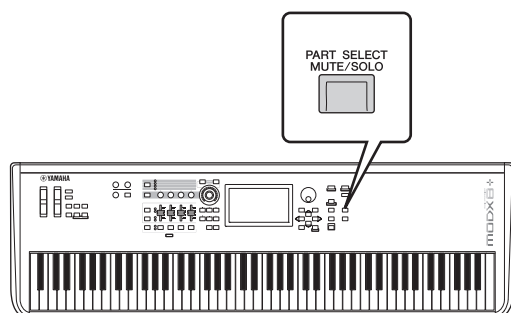

2 Touch the [MUTE] button on the Part Select Window to turn the button on.

3 Touch the number button for the Part you wish to mute. The letter “M” appears on the button, and the corresponding Part will be muted.

You can turn multiple Parts on/off by pressing multiple buttons.

4 To disengage the mute function, with “MUTE” selected, touch the button with the letter “M” shown on it.

The “M” indication disappears and the Mute function is disengaged.

Soloing a specific Part (Solo function)

The Solo function is the opposite of Mute, and lets you instantly solo a specific Part and mute all others.

1 Press the [PERFORMANCE (HOME)] button.

2 Touch the [SOLO] button on the screen to solo the Part.

The [SOLO] button lights, indicating that Solo is enabled. Touch the same button again turns off the button to disengage the solo function.

You can also solo a part by using the [PART SELECT MUTE/SOLO] button with the operation below.

1 While the Performance display is shown, press the [PART SELECT MUTE/SOLO] button.

The Part Select Windows appears on the display.

2 Touch the number button for the Part you wish to solo.

3 Touch the [SOLO] button on the Part Select Window to turn the button on.

The letter “S” appears on the currently selected Part, and the corresponding Part will be soloed.

4 To disengage the solo function, with “SOLO” selected, touch the button with the letter “S” shown on it.

The “S” indication disappears and the Solo function is disengaged.

Using the Arpeggio function

This function lets you trigger rhythm patterns, riffs and phrases using the current Part by simply playing notes on the keyboard.

It not only provides inspiration and full rhythmic passages in your live performances, but it gives you fully formed instrumental backing parts of various music genres for ease in creating songs.

You can assign the desired eight Arpeggio Types to each Part and play back the Arpeggios of up to eight Parts simultaneously.

You can also set the Arpeggio playback method, Note range, Velocity range and Play Effects to create your own original grooves.

NOTE

For details about Arpeggio, see the Reference Manual PDF document.

Turning the Arpeggio on/off

To turn Arpeggio playback on or off, press the [ARP ON/OFF] button on the panel.

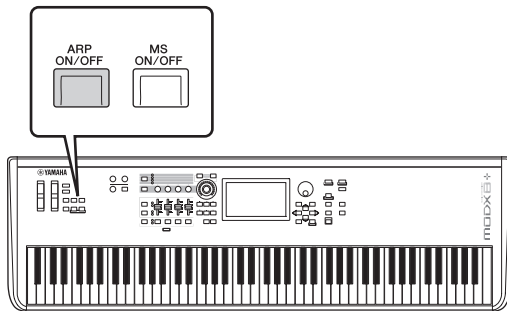

For information on selecting a different Arpeggio type during preparation or switching Arpeggios in the middle of your performance, see "Using the Scene function" (page 34).

Using the Motion Sequencer function

The powerful Motion Sequencer feature lets you dynamically change sounds by operating Parameters depending on sequences created in advance.

It provides real time control for changing sounds depending on various sequences such as Tempo, Arpeggio, or the rhythm of external connected devices.

You can assign up to eight desired Sequence types for one Lane.

You can also set up to four Lanes corresponding to the Motion Sequencer function for one Part. Up to eight Lanes can be used at the same time for the entire Performance.

For the Motion Sequencer function, in addition to being able to set the Arpeggio playback method, you can also set the Velocity range, Play Effects, the amount of steps, and so on, to create your own original grooves.

NOTE

For details about the Motion Sequencer, see the Reference Manual PDF document.

Turning Motion Sequencer on/off

Press the [MS ON/OFF] button on the front panel to turn the Motion Sequencer on/off.

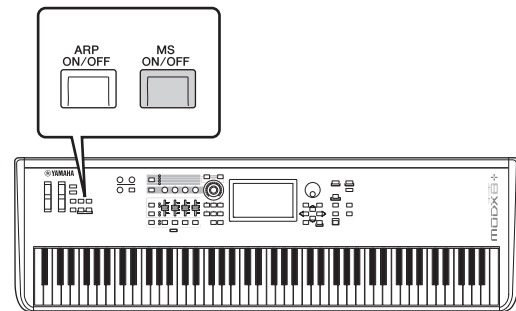

For information on selecting a different Motion Sequence type during preparation or switching Motion sequences in the middle of your performance, see "Using the Scene function" (page 34).

Using controllers to change the sound

The MODX+ gives you an amazing amount of control options. In addition to the conventional Pitch Bend and Modulation Wheels, it also features an extensive array of special real time controls—including the Knobs, Super Knob, Control Sliders, and Assignable Switch buttons.

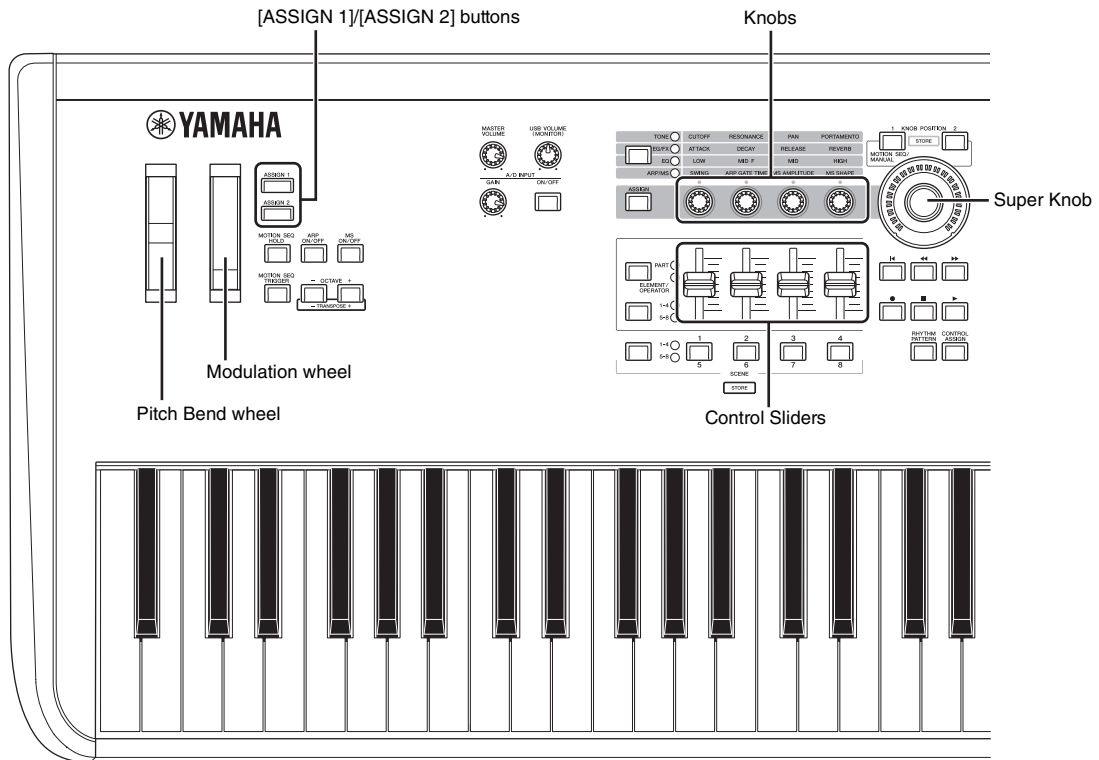

Using the Knobs to change the sound

Knobs 1–4 (5–8) let you adjust a variety of parameters for the current Performance or Part, such as effect depth, attack/release characteristics, timbre, and others. The functions assigned to each Knob can be alternatively selected via the Knob Function button or the [ASSIGN] button. There are basically two ways in which the sound can be controlled: controlling the entire Performance or controlling the specific Part.

■ For controlling the entire Performance

Move the cursor to the desired Performance name from the Performance Play display. Or turn the [PART SELECT MUTE/SOLO] button and select “Common” to enable the Performance Control status, and operate Knobs 1–4 (5–8).

■ For controlling the desired Part

Move the cursor to the desired Part name from the Performance Play display. Or turn the [PART SELECT MUTE/SOLO] button and select any of the “1” to “16” buttons to enable the Part Control status, and operate Knobs 1–4 (5–8).

1 Press the Knob Function [TONE]/[EG/FX]/[EQ]/[ARP/MS] button or the [ASSIGN] button, so that the button corresponding to the function you want to switch is lit.

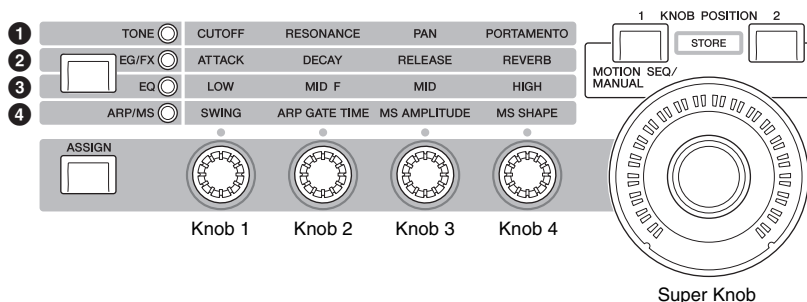

- 1 [TONE]: Switches to functions related to sound settings
- 2 [EG/FX]: Switches to functions related to Envelope Generator (EG) and Effect settings
- 3 [EQ]: Switches to functions related to Equalizer (EQ) settings
- 4 [ARP/MS]: Switches to functions related to Arpeggio and Motion Sequencer settings

The functions currently assigned to the Knobs 1–4 (5–8) and the parameter values of the functions are shown.

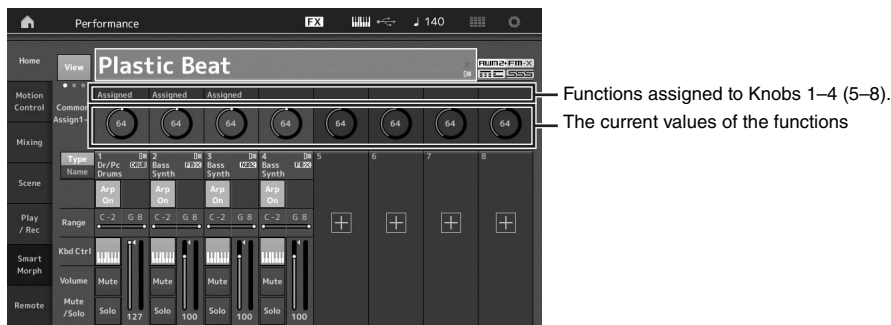

2 Turn a desired knob while playing the keyboard.

The value of the corresponding parameter changes and the function/effect is applied to the sound.

Using the Super Knob to change the sound

The Super Knob lets you simultaneously control all parameter values of the functions assigned to Knobs 1–4 (5–8). You can create complex sounds by using the Super Knob together with the Motion Sequencer.

The Super Knob is always active for use. You don't have to press the Knob Function button or the [ASSIGN] button before using the Super Knob.

Setting Example for Super Knob

Here is an example of a Super knob setting for adding a layer of a morphing sound to the preset Super Knob sound. For the layer, select from two preset Performances—an acoustic piano and a pad sound, for example—and create the sound morph. This allows you to add even more complexity to the preset Super Knob sounds.

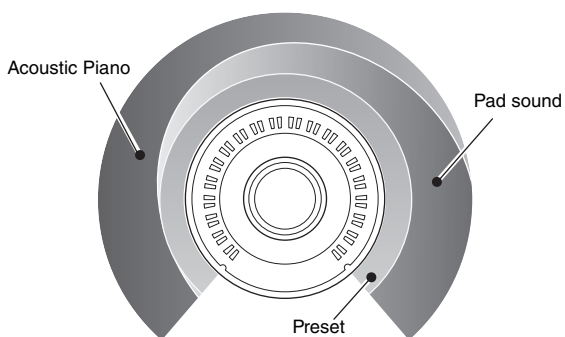

Selecting Performances for the layer

1 Select the Performance for Part 1.

1-1 Press the [CATEGORY] button, and select “CFX PopStudioGrand.”

2 Select the Performance for Part 2.

2-1 In the Performance Play display, select Part 2. Press the [CATEGORY] button while holding down the [SHIFT] button, and select “Ethereal.”

3 Check the current settings.

3-1 Touch the [Motion Control] tab and then the [Overview] tab.
The Motion Control Overview display appears.

3-2 Touch Part [Common], then [1] and [2] to make sure that no green lines are connected (in other words, nothing is assigned) to Assignable Knobs 6 and 7. To see the status of Knobs 5 to 8, press the [ASSIGN] button as needed.

3-2

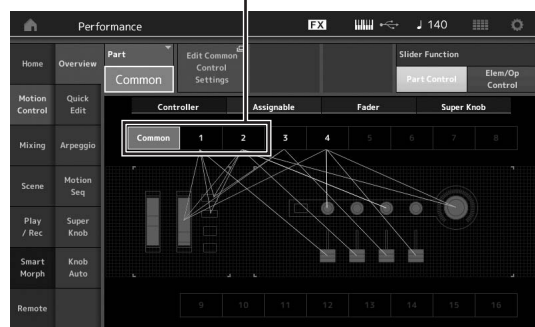

4 Set the instrument parameters for Part 1.

4-1 Touch the [Super Knob] tab.

The Motion Control Super Knob display appears.

4-2 Touch the [Edit Super Knob] button.

The Control Assign display for Common/Audio Edit appears.

4-3 Touch the [+] button.

When the [+] button is not shown, touch the [>] button to go to Page 2, and touch the [+] button.

4-3

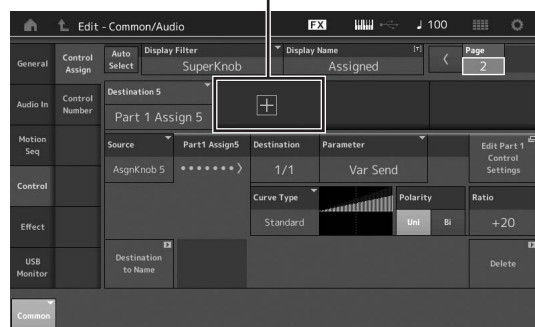

Destination 6 is added.

4-4 On the [Destination 6] tab, set Source to “Asgn Knob 6,” and [Destination6] to “Part 1 Assign 6.”

4-4

4-4

4-5

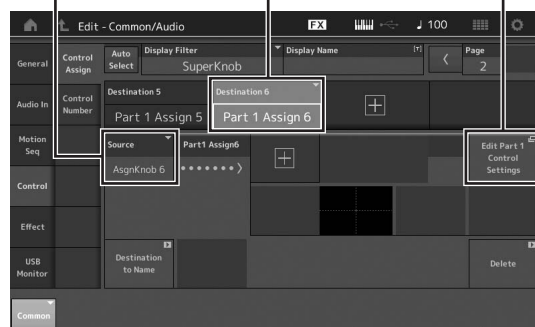

4-5 Touch the [Edit Part1 Control Settings] button.

The Control Assign display for Element Common Edit appears.

4-6 Touch the [+] button.

When the [+] button is not shown, touch the [>] button to go to Page 2, and touch the [+] button.

4-7 Touch the [Destination 10] tab, and select Volume from Part Param.

- 4-8** Adjust other parameters if necessary.
Here, set the Curve Polarity (Polarity) to “Bi,” and the Curve Ratio (Ratio) to “+63.”

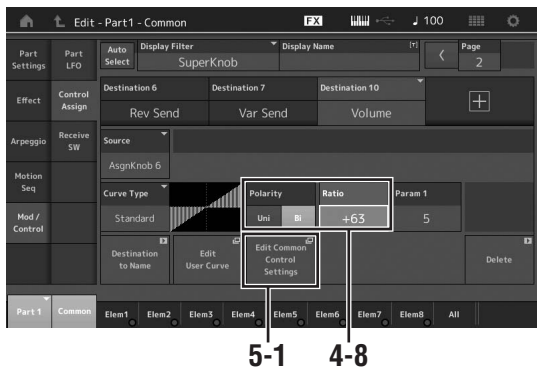

5-1 4-8

5 Set the instrument parameters for Part 2.

- 5-1** Touch the [Edit Common Control Settings] button.
The Control Assign display for Common/Audio Edit appears.
- 5-2** Touch the [+] button.
Destination 7 is added.
- 5-3** On the [Destination 7] tab, set Source to “Asgn Knob 7,” and [Destination 7] to “Part 2 Assign 7.”
- 5-4** Touch the [Edit Part 2 Control Settings] button.
Set the parameters the same as the ones for Part 1.
Here, set the Curve Polarity (Polarity) to “Bi,” and the Curve Ratio (Ratio) to “-64.”

This completes the setting.

■ **When further adjustments are needed**

- Touch the [Edit Common Control Settings] button, and switch between Destination 6 and 7, and adjust the Curve Type or Ratio.
- or
- Press KNOB POSITION [1], turn Knobs 6 and 7 to make a setting for when the Super Knob is turned all the way to the left, and simultaneously press [SHIFT] and KNOB POSITION [1] to store the settings. Next, press the KNOB POSITION [2], turn the knobs again to make a setting for when the Super Knob is turned all the way to the right, and simultaneously press [SHIFT] and KNOB POSITION [2] to store the setting.

Checking the Super Knob settings

This section covers the procedure to check the parameter values changed by operation of the Super Knob.

- 1 Press the [PERFORMANCE (HOME)] button.**
The button lights, indicating that you can make common settings for all Parts.
- 2 With the [View] button off, press the [ASSIGN] button to select Common Assign 1–4 or Common Assign 5–8.**

The button lights when Assign 1–4 is selected, and the button flashes when Assign 5–8 is selected.

The functions currently assigned to Knobs 1–4 (5–8) and the parameter values are shown.

- 3 Turn the Super Knob while playing the keyboard.**

All relevant parameter values are simultaneously changed and all assigned functions are applied to the sound.

NOTE

For details about Knob assignments and Super Knob settings, see the Reference Manual PDF document.

Checking parameters assigned to the Super Knob

To confirm the parameters assigned to Super Knob, open the Super Knob display.

- 1 While the Performance Play display is shown, touch the [Motion Control] tab on the left side of the display.**
- 2 Touch the [Super Knob] tab on the left side of the display.**
The Super Knob display appears.
- 3 On the Super Knob display, touch the [Edit Super Knob].**

The Control Assign display appears.

You can see detailed information for the Super Knob settings within one page. Make adjustments if necessary.

NOTE

The Control Assign display can be opened from the Performance Edit display, by first touching the [Control] tab on the left side of the display, and then touching the [Control Assign] tab.

Controlling the Super Knob by using a foot controller

You can control the Super Knob by using a foot controller (FC7).

- 1 Connect the foot controller (FC7) to the FOOT CONTROLLER [1]/[2] jack.
- 2 Move the cursor to the Performance name on the Performance Play display and then press the [EDIT] button.
- 3 Touch the [Control] tab in the left of the screen → [Control Number] tab.
- 4 Set “Foot Ctrl 1” or “Foot Ctrl 2” to “Super Knob”—depending on which jack you connected the foot controller (FC7).

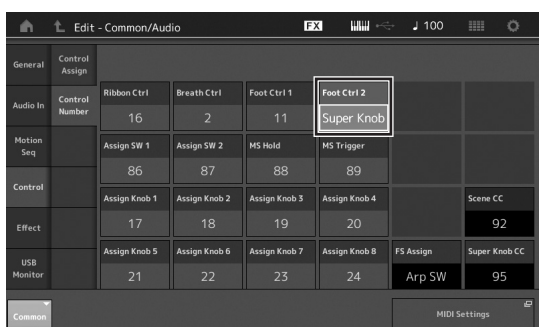

Mixing

Each Mixing can contain up to 16 Parts and a separate Mixing can be created for each Part. You can adjust the various mixing related parameters for each Part: volume, pan, etc.

Basic procedure for Mixing

- 1 Touch the [Mixing] tab on the left side of the Performance Play display.

The Mixing display appears.

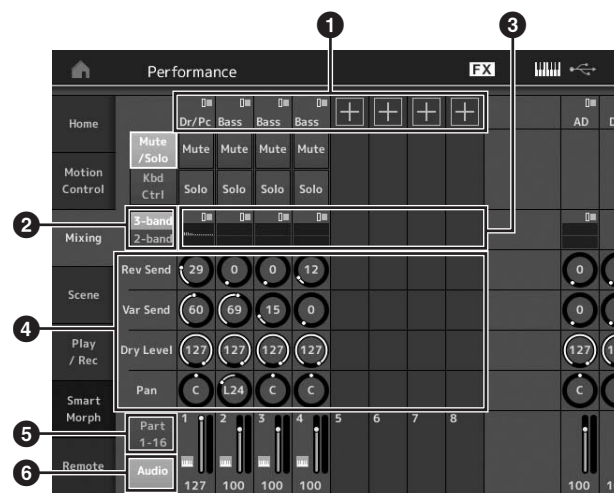

- 1 Main category for each Part
- 2 Switching displays between 3-band EQ / 2-band EQ
- 3 EQ setting for each Part
- 4 Parameter values for each Part
- 5 Changing the display for Parts 1–16
- 6 Changing the display for the audio Parts (Parts 9–16 are not displayed)

- 2 Press the [PART SELECT MUTE/SOLO] button → [1]–[16] buttons to select the desired Part for which you want to adjust the parameter values.

NOTE

By touching [Audio] (6) on the screen, the audio Part are shown. You can set the parameters relating to the audio data (AD Part) input from the A/D INPUT [L/MONO]/[R] jacks and the audio data (Digital Part)* input from the [USB TO HOST] terminal.

*The audio data which is set as “Digital L/R” among device ports

- 3 Move the cursor to the parameters for each Part and change the parameter values by turning the Data dial.

NOTE

- For more detailed parameter settings, press the [EDIT] button in the Mixing display to open the Edit display.
- For details about the Mixing parameters and Mixing Edit, see the Reference Manual PDF document.

Using the Scene function

You can store all parameter settings such as Arpeggio type, Motion Sequencer type, and the Part parameter values together as a “Scene.” There are eight Scenes and you can select them by pressing the [SCENE] button.

This is useful for simultaneously and drastically changing the Arpeggio type and the Motion Sequencer type while you are playing a single Performance.

Changing Scene settings

1 Touch the [Scene] tab on the left side of the Performance Play display.

The Scene display appears.

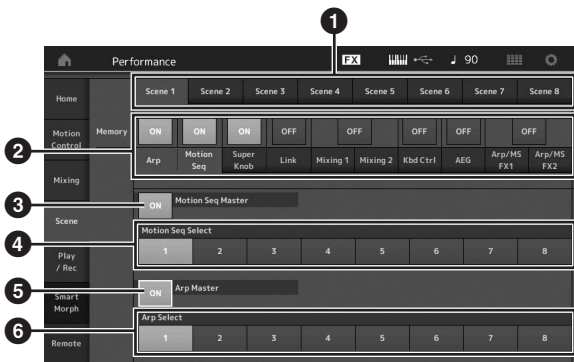

- 1 Switching among Scenes 1–8
- 2 Turning functions for each Scene on/off
- 3 Turning the Motion Sequencer for All Parts on/off
- 4 Motion Sequencer type of the currently selected Scene
- 5 Turning the Arpeggio for all Parts on/off
- 6 Arpeggio type of the currently selected Scene

NOTE

Sections 3 to 6 (see illustration above) are displayed only when “Arp” and “Motion Seq” are selected in section 2.

2 Set Scenes 1–8 as desired.

When [Memory] is turned on for the function, the Motion Sequencer type, or the Arpeggio type, the corresponding function information is automatically memorized to the currently selected [SCENE] button. By pressing one of the SCENE [1]–[8] buttons, the Scenes 1–8 are switched and stored information for each Scene is restored.

NOTE

You can also change Scene Settings from other setting displays. After changing the parameters from other setting displays using Knobs or Control Sliders to which you have previously assigned parameters from the Scene Settings display, press one of the SCENE [1]–[8] buttons while holding down the [SHIFT] button to store the settings.

3 Store the Performance as necessary (page 37).

NOTICE

If you select a different Performance or turn off the power without storing your edited Performance, all the edits you’ve made for the Scene will be erased.

Creating Your Own Live Sets

The Live Set is ideal for live performance situations since it lets you instantly switch among desired Performances. You can create your own Live Set by simply grouping together your favorite Performances.

Registering a Performance to a Live Set

Follow the instructions below to store Performances to Live Sets.

NOTICE

- Before storing the currently editing Performance to the Live Set, store the Performance itself (page 37).
- If you select a different Performance or turn off the power without storing your edited Performance, all the edits you've made will be erased.

- 1 Select the Performance you want to use.
- 2 Hold down the [SHIFT] button and press the [LIVE SET] button.

The Live Set display appears.

Live Set display

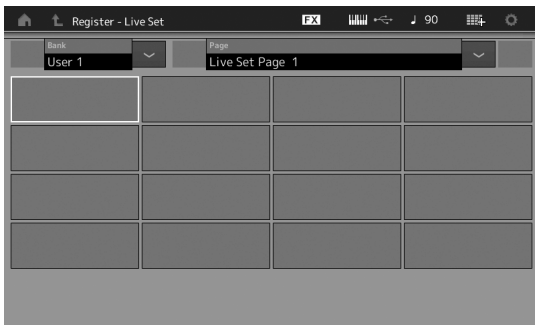

- 3 Touch one of the slots. The currently selected Performance will be registered in the slot.

The performance registered in the slot

An empty slot



Sorting registered Performances in a Live Set

You can change the order of the Performances registered to a Live Set on the Live Set Edit display.

- 1 Press the [EDIT] button while the Live Set display is shown.

The Live Set Edit display appears.

(The Live Set Edit display will not be shown if a Live Set of the preset bank/library bank is open.)

- 2 Select the slot containing the Performance you want to move and touch [Swap] on the screen.

The [Swap] lights up and now the slot can be changed.



- 3 Select the desired destination slot.

The original slot and the destination slot are switched with each other.

Switching Performances stored in a Live Set by using the footswitch

You can switch the Performances by using a connected footswitch (FC4 or FC5). The setting for this operation is as follows.

- 1 Connect the footswitch (FC4 or FC5) to the FOOT SWITCH [ASSIGNABLE] jack.**
- 2 Press the [UTILITY] button to call up the Utility display, and then touch [Settings] tab → [MIDI I/O] tab at the left side of the screen.**
- 3 Set “FS Assign” to “Live Set +” or “Live Set -.”**

When “Live Set +” is selected, the Performances are switched in forward order. When “Live Set -” is selected, the Performances are switched in reverse order.

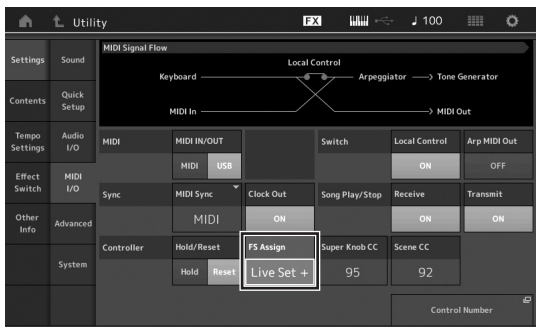

Editing the Settings

This instrument has various edit displays for Parts, Performances, effects, and Arpeggios. This chapter explains how to create an original Performance by combining multiple Parts.

Performance Editing

“Performance Editing” refers to the process of creating a Performance by changing the parameters that make up the Performance. This can be done in the Performance Edit display.

Basic operations for editing a Performance

- 1 Move the cursor to the Performance name on the Performance Play display, then press the [EDIT] button.
- 2 Touch the [General] tab at the left side of the screen to edit the Performance.

Performance Edit display

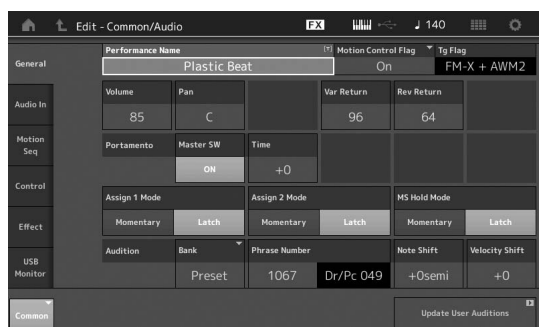

Storing the Performance (Store)

After editing, store the Performance to internal memory. Press the [STORE] button to store the Performance.

NOTICE

- The edited Performance will be lost when selecting a different Performance or turning the power off.
- If you overwrite a Performance in the User bank, it will be permanently deleted. When you store the edited Performance, be careful not to overwrite any important User Performances. Important data should always be saved to a USB flash drive connected to the [USB TO DEVICE] terminal. For detailed instructions on saving, see page 60.

NOTE

You can select any desired Part by using the [PART SELECT MUTE/SOLO] buttons during editing of the Performances, and edit the selected Part.

- 1 Press the [STORE] button to call up the Store display.

Storing a new Performance

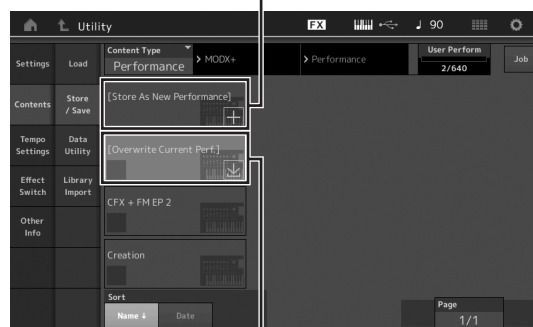

Performance previously stored

- 2 Set the destination for storing the Performance.

To store the newly edited Performance, touch “+” in the [Store As New Performance] section.

NOTE

To overwrite the previously stored Performance, touch [Overwrite Current Perf.] or the Performance to be overwritten.

- 3 The Text Input display appears. Input the name of the stored Performance.

For detailed instructions on inputting characters, see “Naming (character inputting)” in “Basic Operation and Displays” (page 21).

- 4 Select “Done” on the Text Input display to actually execute the Store operation.

NOTE

If you are overwriting the previously stored file, a confirmation display appears after Step 2. Select “YES” to execute the Store operation.

Part Editing

“Part Editing” refers to the process of creating a Part by changing the parameters that make up the Part. This can be done in the Element Common/Key Common/Operator Common Edit display and the Element/Key/Operator Edit display. The actual parameters that are available differ depending on the Part type.

Normal Part (AWM2) Edit

A Normal Part (AWM2) (having pitched musical instrument sounds) can consist of up to eight Elements. An Element is the basic, smallest unit for a Part. There are two types of Normal Part (AWM2) Edit displays: Element Common Edit display, for editing settings common to all eight Elements; and Element Edit display, for editing individual Elements.

An Element is created by applying various parameters (Effect, EG, etc.) to the waveform of the instrument sound. A Normal Part of this instrument (AWM2) consists of up to eight Elements.

Normal Part (FM-X) Edit

A Normal Part (FM-X) (assigned FM-X sounds) can consist of up to eight Operators. There are two types of Normal Part (FM-X) Edit displays: Operator Common Edit display, for editing settings common to all eight Operators; and Operator Edit display, for editing individual Operators.

The abbreviation “FM” of FM-X stands for “frequency modulation,” which is special tone generation system that uses one waveform’s frequency to modulate another waveform, to produce a completely new one. Waveforms are generated by “operators,” of which the MODX+ has eight. An operator that generates a fundamental waveform is a “carrier,” and an operator that modulates these waveforms is a “modulator.” Each of the eight operators can be used as either a carrier or a modulator. By changing the way operators are combined and controlling the modulation with other parameters such as levels and envelopes, you can create richly textured sounds that change in a highly complex fashion.

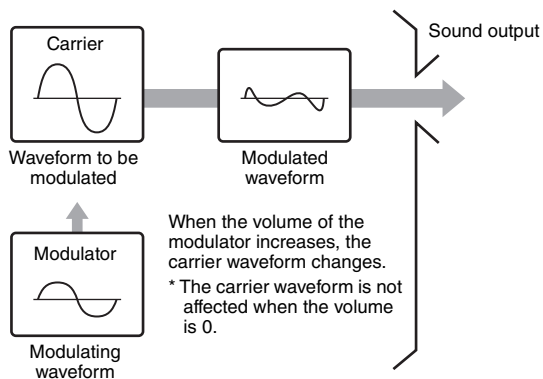

Drum Part Edit

There are two types of Drum Part Edit displays: Key Common Edit display, for editing the settings that apply to all Drum keys; and Key Edit display, for editing individual keys.

Drum Parts are mainly percussion/drum sounds that are assigned to individual Keys. You can create various drum Parts by changing assigned sound types and adjusting the pitch and EQ.
Drum Parts of this instrument consist of up to 73 Keys.

Basic operation of Part Edit

1 Move the cursor to the Part you want to edit in the Performance Play display, then press the [EDIT] button.

You can also use [PART SELECT MUTE/SOLO] button to select a Part.

2 Touch the [Part Settings] tab at the left side of the screen → [General] tab to edit the desired Part.

■ For Normal Parts (AWM2)

For Element Common Editing, touch the Element [Common] tab.

For Element Editing, press the corresponding Number button of the element to be edited from among the [Elem1]-[Elem8] tabs.

■ For Drum Parts

For Key Common Editing, touch the Drum Key [Common] tab.

For Key Editing, press the tab corresponding to the Drum Part you want to edit (BD, SD, etc.).

You can switch the Keys of each instrument sound (assigned to C1 to C#2) by using the [BD]-[Crash] tabs. For selecting Keys other than the Keys assigned to C1 to C#2, turn on “Keyboard Select” on the display and play the note assigned the Key to be edited.

■ For Normal Parts (FM-X)

For Operator Common Editing, touch the Operator [Common] tab.

For Operator Editing, press the corresponding Number button of the operator to be edited from among the [OP1]-[OP8] tabs.

NOTE

For details about the Part parameters, see the Reference Manual PDF document.

■ Element Common Edit display

Indicates that the Element Common Edit display is active.

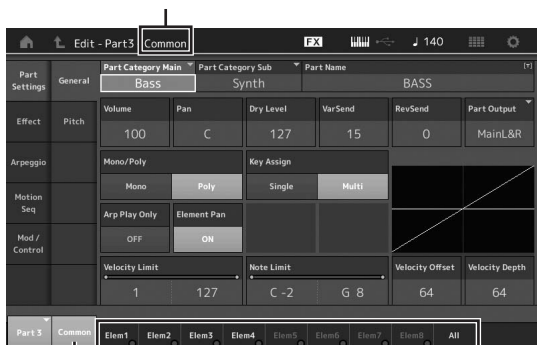

Switches between Element Common Edit and Element Edit.

The structure of the display is the same as for the Key/Operator Common Edit display.

■ Element Edit display

Indicates that the Element Edit display is active.

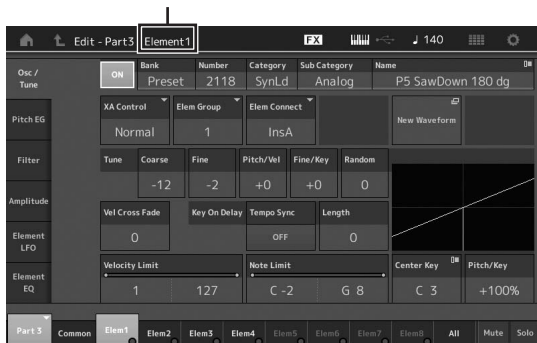

The structure of the display is the same as for the Key/Operator Edit display.

3 Store the Performance as necessary.

Part Effect Editing

This instrument features a wide variety of Effects, letting you add Variation and Reverb processing to the selected Part for your keyboard performance. Simply changing the Effect type applied to the preset Part lets you instantly come up with different sounds. The instructions below explain how to set the Effect type and the related parameters applied to the Part, and then store the settings as a User Performance.

- 1 Move the cursor to the Part to be edited on the Performance Play display, and then press the [EDIT] button.
- 2 Touch the Element [Common] button.
- 3 Touch the [Effect] tab in the left of the screen → [Routing] tab.
The Effect display for Element Common Edit appears.

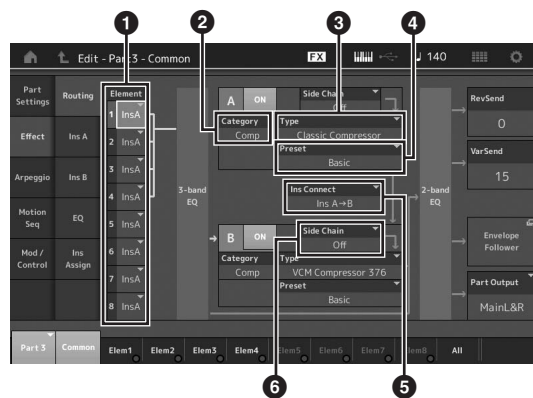

- 1 Output of each Element/Key
 - 2 Category of Insertion Effect A
 - 3 Type of Insertion Effect A
 - 4 Preset of Insertion Effect A
 - 5 Connection method between Insertion Effects A and B
 - 6 Selection of Side Chain/Modulator
- 4 Set the output of each Element/Key (1).
 - 5 Select the parameters (Effect category (2), Effect type (3), and Effect preset (4)) corresponding to Insertion Effect A.
 - 6 Set the connection method between Insertion Effects A and B (5).
 - 7 Set the Side Chain/Modulator of Insertion Effect B (6).

NOTE

The Side Chain/Modulator uses the output from one track to control an effect in a different track. You can specify the Effect type for activating the feature so that input signals for Parts other than the selected Part or the audio input signal can control the specified Effect. This trigger is called "Side Chain" or "Modulator" depending on the Effect Type.

8 Touch the [Ins A] tab at the left side of the screen.

The display for editing effect parameters selected in Step 4 appears.

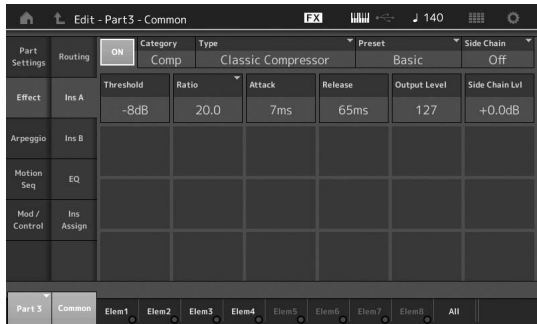

9 Set the parameters as necessary.

Try narrowing in on your desired sound by finely editing the parameters provided for each Effect Type.

Compare function

The Compare function lets you switch between the just-edited sound and its original, unedited condition, allowing you to hear how your edits affect the sound.

Press the [EDIT] button while the Edit display is shown, so that the [EDIT] button flashes. In this status, the sound settings prior to editing will temporarily be reinstated for comparison purposes. Press the [EDIT] button again to return to the original status.

10 Edit Insertion Effect B by using the same operation.

11 Store the Performance as necessary.

How Parts are assigned to a Performance

By default (when shipped from the factory), various types of Performances are provided in the Preset Banks. For some of these Performances, it may not be immediately obvious how to play them or use them, since they are quite complicated. In this section, you'll learn the typical ways in which Performances are created, and thus better understand how to play and use them. This section covers the typical four Part assignments.

Performance Structure

Layer

This method lets you play multiple (two or more) Parts simultaneously by pressing any notes.

For example, you can create a thicker sound by combining two similar Parts—for example, two different Strings Parts, each with a different attack speed.

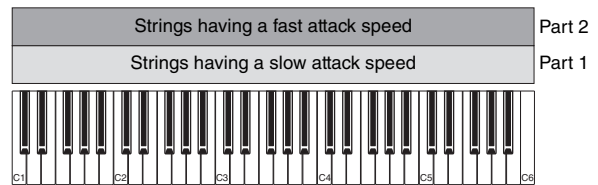

Performance Structure

Split by Note range

This method lets you play different Parts with your left hand and right hand. By assigning a Strings Part to the lower range and assigning a Flute to the higher range separately as illustrated below, you can play Strings accompaniment with your left hand and while playing Flute melody with your right hand.

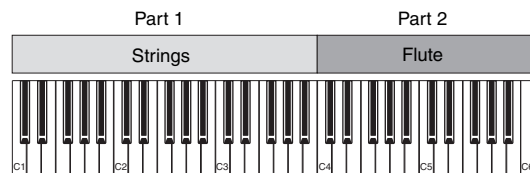

Performance Structure

Split by Velocity range

This method lets you trigger different Parts depending on your playing strength (velocity). In this example below, playing notes at low velocities triggers Strings sounds with a slow attack speed. Playing notes at middle velocities triggers Strings sounds with a fast attack speed. Playing notes at high velocities triggers Orchestra Hits.

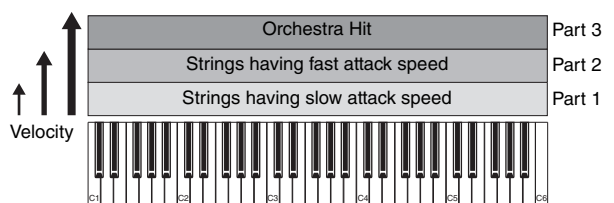

Performance Structure

Using Arpeggios

With this method, you can play all the parts of a band by yourself. With the MODX+, you can assign different Arpeggio types to each of the eight Parts in a Performance. For example, you could assign four different Arpeggio types to four Parts, as shown below, so that Bass Arpeggios are played on the lower range of the keyboard, Guitar and Piano Arpeggios on the upper range, and Drum Arpeggios on all ranges of the keyboard. Then, by simply playing the appropriate ranges of the keyboard, you can add full, dynamic accompaniment to your performance. In addition, you can change the Arpeggio Type assignment from [Motion Control] → [Arpeggio] on the display, allowing you to set different Arpeggio Types for the intro, verse, chorus, and ending of your song.

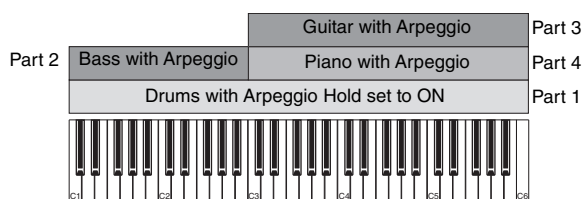

Using or combining the four methods described above gives you the ability to create a rich variety of Performances. By default, many Performances stored in the Preset Banks have been created via the above methods. Try out various Performances and see which method is used for each.

Creating a Performance by combining Parts

After checking out the pre-programmed Performances in the Preset Banks, try creating your own original Performance. In this section, we'll create a Performance by combining two Parts.

Selecting a Performance

For demonstration purposes, we'll assign a piano sound to Part 1.

- 1 Move the cursor to the Part name of the Part 1 on the Performance Play display and press the [CATEGORY] button while holding down the [SHIFT] button.**

The Part Category Search display appears.

- 2 Select [Full Concert Grand] from the Performance list.**

- 3 Press the [EXIT] button.**

Playing several Parts together (Layer)

Try combining two Parts by assigning a favorite Part to Part 2.

- 1 Move the cursor to the Part name of the Part 2 on the Performance Play display and select the desired sound by pressing the [CATEGORY] button while holding down the [SHIFT] button.**

- 2 Play the keyboard.**

The Part 1 (Piano) and Part 2 (the sound you have selected above) are sounded simultaneously in a layer.

- 3 Press the [EXIT] button.**

Next, let's play different Parts with the left and right hands.

Split

You can play different Parts with the left and right hands by assigning one Part to Part 1, with a note range in the lower section of the keyboard, and a different Part to Part 2, with a note range in the higher section of the keyboard.

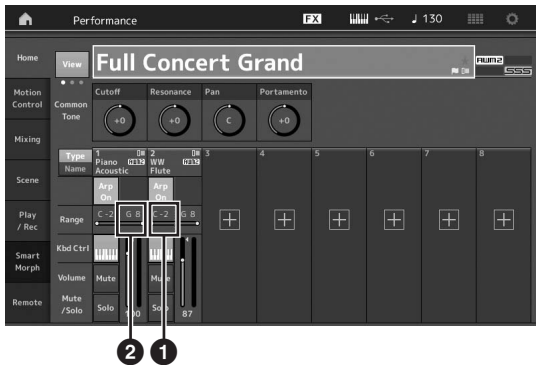

- ❶ Note Limit Low (the lowest note of the range for the Part)
- ❷ Note Limit High (the highest note of the range for the Part)

- 1 Touch the Note Limit High (❷) of Part 1 or move the cursor to ❷ and press the [ENTER] button.
- 2 Touch the [Keyboard] menu at the left side of the screen to turn it on.
- 3 Set the highest note of Part 1 by pressing the corresponding key.
The note number in the Range section of Part 1 changes.
- 4 Touch the Note Limit Low (❶) of Part 2 or move the cursor to ❶ and press the [ENTER] button.
- 5 Set the lowest note of Part 2 by pressing the corresponding key.
The note number in the Range section of Part 2 changes.
- 6 Touch the [Keyboard] menu at the left side of the screen to turn it off.
- 7 Play the keyboard.

The notes you play with your left hand sound the Piano Part (Part 1), while the notes you play with your right hand sound the different Part (Part 2) you have selected.

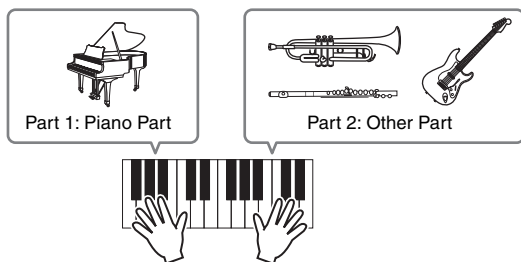

- 8 Press the Slider Function [PART]/[ELEMENT/OPERATOR] button to select “PART.”
- 9 Use the Control Sliders 1 and 2 to adjust the volume for Parts 1 and 2.

Changing the note range of the split Part to one octave lower

Change the note range of Part 2 to one octave lower.

- 1 Move the cursor to Part 2 and press the [EDIT] button for Part edit.
- 2 Touch the [Part setting] tab at the left side of the screen → [Pitch] tab.

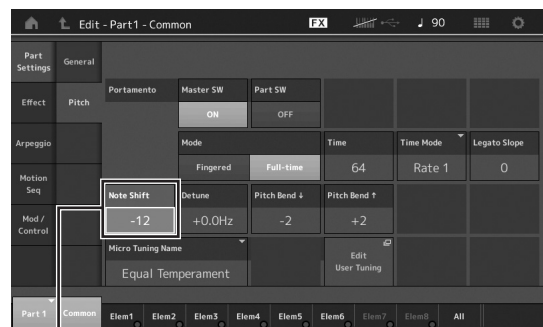

Note Shift

- 3 Select “Note Shift” to adjust the Pitch.
The pitch is shifted in semitone steps. Set “-12” to make the note range one octave lower.
- 4 Play the keyboard.

Changing the Arpeggio settings for each Part

Try changing the Arpeggio settings for each Part. You can assign the rhythm or backing pattern that best matches the desired style of music to the Performance.

- 1 Move the cursor to Part 1 and press the [EDIT] button to call up the Element Common Edit display.

- 2 Touch the [Arpeggio] tab at the left side of the screen → [Common] tab (near the top of the display).

The display for setting common Arpeggio parameters for all Arpeggio type appears.

Note that the Arpeggio Hold parameter is useful as well as the Arpeggio type selection. When this parameter is set to “on,” the Arpeggio playback continues even if the note is released. This parameter should be set to “on” when a Drum sound is assigned to the Part and you wish to have playback of the Arpeggio (rhythm pattern) continue regardless of whether you hold the note or not.

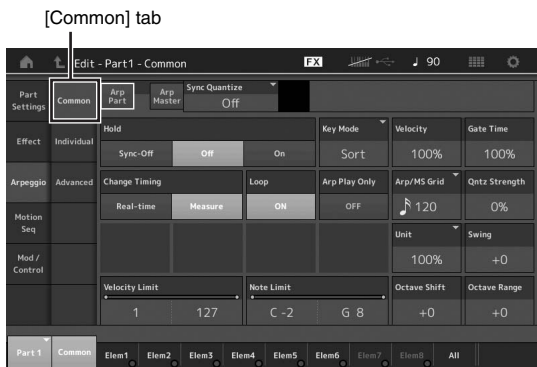

- 3 Touch the [Individual] tab to call up the setting display for each Arpeggio Type.
- 4 Touch the Arpeggio type and select the [Category Search] menu at the left side of the screen. (Alternately, you can press the [CATEGORY] button.)

The Category determines the instrument type and the Sub Category determines the music type. The Arpeggio types include variations for each section of the song, such as intro, verse, refrain, chorus, and bridge. Play the keyboard to hear the arpeggios to select one you like.

Setting of Arpeggio type

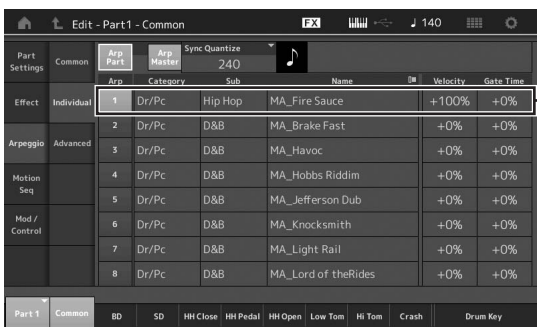

Go on and assign other Arpeggio types in the same way as desired.

- 5 Store the Performance as necessary.

Using the Rhythm Patterns

The [Rhythm Pattern] button provides a simple way to add a rhythm part to the current Performance. By combining rhythm patterns and the Envelope Follower, you can modify the patterns even further.

Here, as an example, we explain how to add the rhythm pattern “8Z Trance Basics 1” to the Performance “Supertrance,” and then modify the sound with the Envelope Follower.

Adding a Rhythm Part (simple way)

- 1 Select the desired Performance for adding the rhythm part.

Here, select “Supertrance.”

- 2 Press the [RHYTHM PATTERN] button.

The Rhythm Pattern display appears.

When all of the parts in Part 1 to 8 are already in use, the message “Part Full” appears and the rhythm pattern cannot be added.

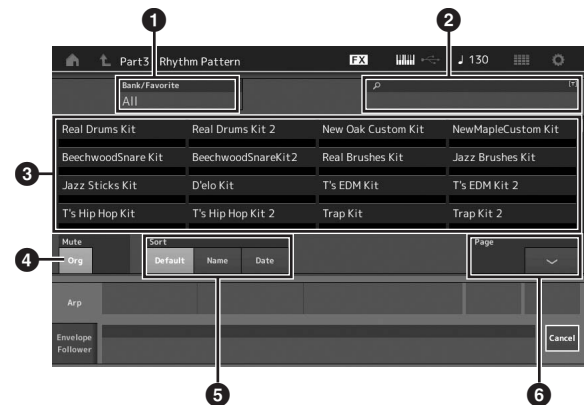

- 1 Bank/Favorite
- 2 Name Search
- 3 Kit Selection
- 4 Mute
- 5 Sort
- 6 Switching pages

- 3 From the Rhythm Pattern List, touch the Rhythm Pattern kit you want to use.

Here, touch “8Z Trans Basics1.”

A rhythm part is added.

- 4 Play the keyboard and the rhythm pattern starts playing.

5 Press the [PERFORMANCE (HOME)] button or [EXIT] button to set the Rhythm Pattern.

The Rhythm Pattern display closes.

NOTE

You can also touch the HOME icon to confirm the selection.

6 To stop the rhythm pattern, press the [ARP ON/OFF] button or the [■] (Stop) button.

NOTE

You can also stop the rhythm pattern by touching the [Arp Hold On] button on the display.

Setting the Envelope Follower

Envelope Follower is a feature that extracts the envelope (or amplitude envelope) of a waveform from the input signals, and then lets you use that envelope as a controller for modifying sounds. For example, by assigning a rhythm pattern to a Part and setting the Envelope Follower of the Part as a “Source,” the sound of other Parts are modified accordingly. This is especially useful for automatic “ducking,” where you want to lower the volume of other instruments while a certain instrument sound is being played.

1 Touch the [Envelope Follower] tab at the bottom of the Rhythm Pattern display.

The Envelope Follower display appears.

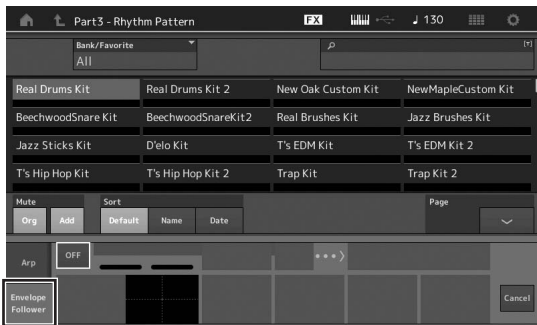

2 Turn the Envelope Follower switch “ON.”

Here, you can play the keyboard to hear the sound with the Envelope Follower enabled.

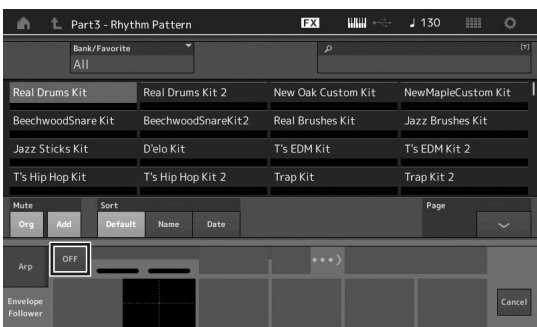

3 Adjust settings as needed.

Here, in this example, set the Curve Polarity (Polarity) to “Bi,” the Curve Ratio (Ratio) to “-63,” and the Gain (Gain) to “-12dB.”



For setting other parameters, touch the [EDIT] button on the screen, and open the Envelope Follower Setting display.

When you want to change the Rhythm Pattern kit or the Arpeggio Type, press the [RHYTHM PATTERN] button to go back to the Rhythm Pattern display. The Envelope Follower settings are retained even after the new kit or the Arpeggio type is selected.

Recording and Playback

You can record your performance on the MODX+ as MIDI data (Songs or Patterns) to the internal storage, or as audio data to a USB flash memory plugged into the instrument.

Terminology

Song

A Song on this instrument is effectively the same as a song on a MIDI sequencer, and playback automatically stops at the end of the recorded data. The MODX+ can store up to 128 Songs.

Track

This is a memory location on the sequencer where your musical performances (made up of MIDI events) are stored. The MODX+ provides 16 tracks, which correspond to the 16 Mixing Parts.

Realtime Recording

The instrument records the performance data as it is played along with a metronome. Realtime Recording features three available methods: Replace, Overdub and Punch In/Out.

- Replace lets you overwrite an already recorded Track with new data, erasing the previously recorded data.
- Overdub lets you add more data to a Track that already contains data—in other words, recording new notes on top of the previous ones.
- Punch In/Out lets you re-record selectively over a specific area of the Track.

Pattern

A Pattern is a set of sequences for repeating the same performance on each Scene (such as intro, verse, bridge, and ending). By recording the performances of each Scene and then combining them, you can efficiently create songs, and play them flexibly during live performances. For MODX+, you can record up to 8 Scenes with 16 tracks per Pattern, and you can save up to 128 Patterns.

MIDI (Song) Recording

This instrument features two sequencer types (Song and Pattern) for recording your keyboard performance as MIDI data. This function allows you to instantly store phrases that you improvise, create and perform. You can create full, complex multi-instrument arrangements and complete songs, using DAW software.

The Song sequencer lets you record an entire song, and the Pattern sequencer lets you create entire songs by combining the individual 'building-block' performances recorded for each Scene.

This section explains how to record a Song using the Song sequencer. For more information on Pattern recording and Pattern sequencers, please refer to the Reference Manual.

Recording to a track

In this section, you'll learn how to record your keyboard performance, by recording a part to Track 1. However, you'll first need to set up the MODX+ for recording.

1 Touch the [Play/Rec] tab in the left of the Performance Play display.

The recording display appears.

2 Touch the [MIDI] tab in the left of the screen.

3 Press the [●] (Record) button.

The Record Setup display appears.

NOTE

Alternately, you can simply press the [●] (Record) button in the Performance display, to perform Steps 1–3 at once.

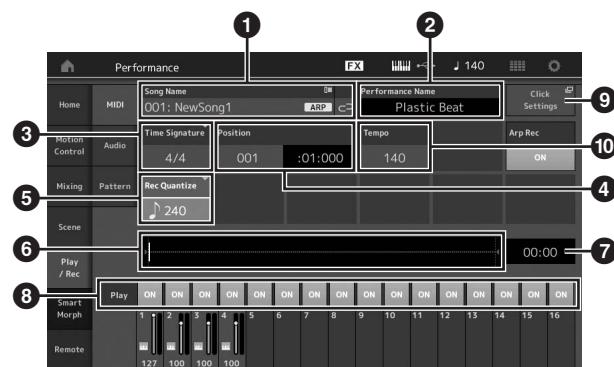

- 1 Song name
- 2 Currently selected Performance name
- 3 Time Signature (Meter)
- 4 Position (starting position of Recording/Playback)
- 5 Quantize
- 6 Position corresponding to the entire sequence
- 7 Recorded time of the entire sequence
- 8 Playback on/off for each track
- 9 Shortcut to the Tempo Settings display
- 10 Changing the tempo

4 Set the following parameters on the Record Setup display.

- 4-1** Move the cursor to Time Signature (Meter) (3), and then set the value. For this example, set this to “4/4.”
- 4-2** Set Quantize to “240 (8th note)” in Record Quantize (5). This convenient feature lets you automatically quantize (or “clean up” the timing of) the notes in real time, as you record. Quantize aligns the timing of note events to the nearest beat. Normally, the smallest note value in the notation (if you’re playing from sheet music) should be set.

5 After completing recording setup, press the [▶] (Play) button to start recording.

Press the [▶] (Play) button, then actually start recording after the count-in.

6 When you’ve finished playing, press the [■] (Stop) button to stop recording.

If you’ve played any wrong notes, press the [■] (Stop) button, then try recording again.

Recording with the click

Follow the steps below to use the click during MIDI recording.

- 1 Press the [UTILITY] button and touch [Tempo Settings] (or Touch the [Click Settings] button where available) on the screen to call up the Tempo settings display. Set the Click “Mode” to “Rec.”**

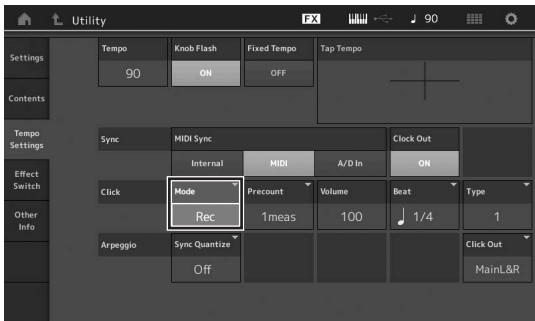

NOTE

When “Rec/Play” is set, the click sounds during MIDI recording and playback. When “Always” is set, the click will always sound.

Re-recording a specific part of a Song (Punch In/Out)

Use the Punch In/Out recording method to record over only a specific portion of the Track. If you set the start point (Punch In) and end point (Punch Out), and then start recording from the top of the Song, the actual recording will be done only between the Punch In and Punch Out points. In the eight-measure example below, only the third through the fifth measures are re-recorded.

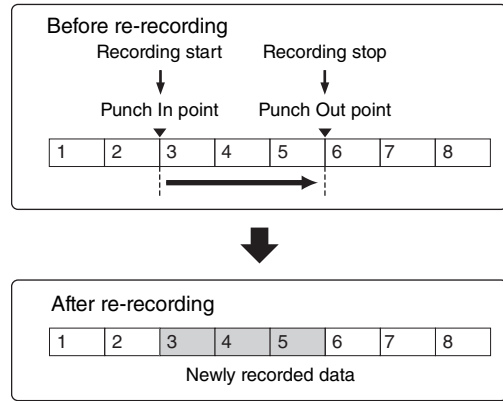

NOTE

Note that the Punch In/Out method always replaces (destroys) the original data over the specified area.

To execute Punch In/Punch Out recording in the above condition, set the following parameters beforehand on the Record Setup display.

- 1** “Record Type”: “punch”
- 2** Punch In: 003:01
Playback of the recording Track is turned off from this point, and your keyboard performance will be recorded to the Track.
- 3** Punch Out: 006:01
Recording ends at this point and normal playback of the recording Track starts.

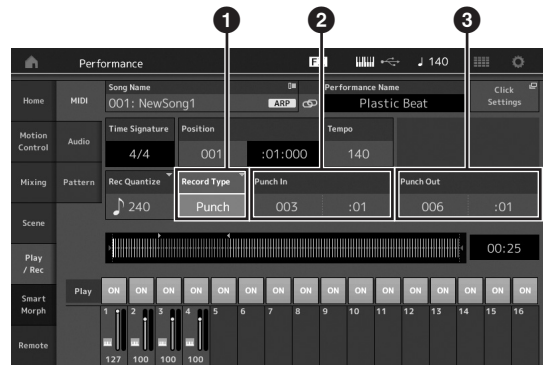

Cancelling your most recent recording (Undo/Redo)

The Undo Job cancels the changes you made in your most recent recording session and restores the data to its previous state. Redo is available only after using Undo, and lets you restore the changes you made before undoing them.

- 1 Undo (This display is not available if nothing has been recorded.)
When [Undo] is touched, the display prompts you for confirmation. Selecting Undo cancels the previous recording.



- 2 Redo (This display is not available if Undo has not been operated.)
When [Redo] is touched, the display prompts you for confirmation. Selecting Redo restores the change you made.



Playing a Song

In this section, you'll learn how to use convenient mute/solo functions while playing back a recorded song.

Song playback

- 1 Press the [▶] (Play) button to start the Song.

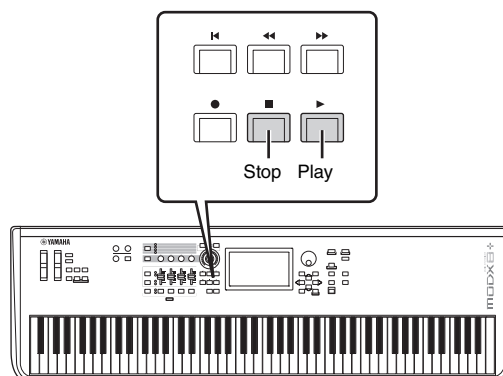

NOTE

To adjust the volume level of the Songs, use the [MASTER VOLUME] knob.

- 2 Press the [■] (Stop) button to stop the Song.

Adjusting the volume of each Part

You can adjust the volume for each of four Parts, using the Control Sliders.

[PART]/[ELEMENT/OPERATOR] button

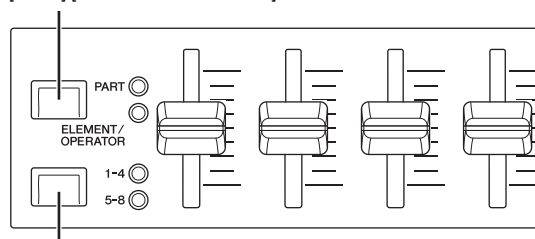

Slider Select [1-4] [5-8] buttons

You can change the volume for Parts 5-8 by first pressing the [PART]/[ELEMENT/OPERATOR] button to select PART, and then pressing the Slider Select [1-4] [5-8] button.

In addition to sliders, the Knobs 1-4 (5-8) can be used to affect the Part setting of the Song playback in real time. For details, refer to the Reference Manual PDF document.

Recording your performance as audio

Your performances on the MODX+ can be recorded as WAV format (44.1-kHz, 24-bit, stereo) audio files to a USB flash drive. The recording level is fixed, and it is possible to record continuously for up to 74 minutes (assuming that the USB storage device has sufficient free memory).

NOTICE

The MODX+ should never be turned off during recording, playback, or while the recorded audio file is being saved. Turning off the MODX+ at that time may make it impossible to subsequently access the USB flash drive.

- 1 **Connect a USB flash drive to the [USB TO DEVICE] terminal of the MODX+.**
- 2 **Touch the [Play/Rec] tab in the left of the Performance Play display.**
The recording display appears.
- 3 **Touch the [Audio] tab in the left of the screen.**
- 4 **Press the [●] (Record) button to setup the audio recording.**
The Record Setup display appears.

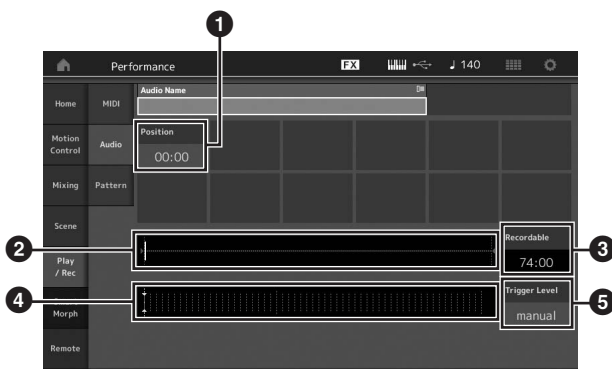

- 1 Play position
- 2 Current play position in the entire audio data
- 3 Available recording time
- 4 Level meter
- 5 Trigger level

5 Set the required trigger level (5).

If you set the trigger level to “manual,” recording will begin whenever you press the [▶] (Play) button. Alternatively, if you set a value between 1 and 127, recording will begin automatically whenever the playback volume exceeds that level. The level set here will be indicated by blue triangles in the level meter (4). For best results, set this parameter as low as possible to capture the entire signal, but not so low as to record unwanted noise.

6 Press the [▶] (Play) button.

If you have set the trigger level to “manual,” recording will begin immediately right after you press the [▶] (Play) button. While the recording, the [●] (Record) button will light red and the [▶] (Play) button will light green. If you have set a value between 1 and 127 as the trigger level, the recording will begin automatically whenever the playback volume exceeds that level.

7 Play the keyboard.

If you set the trigger level to a value between 1 and 127, recording will begin automatically whenever the playback volume exceeds that level.

8 When you have finished playing, press the [■] (Stop) button.

The recorded audio file will be saved on the selected device.

Playing an audio file

As described below, the MODX+ can play audio files (.wav) from a USB flash drive, regardless of whether they have been created by the instrument itself or come from another source.

- 1 **Connect a USB flash drive to the [USB TO DEVICE] terminal of the MODX+.**
- 2 **Touch the [Play/Rec] tab → [Audio] tab at the left side of the Performance display.**
- 3 **Touch “Audio Name” and then select [Load] menu at the left side of the screen.**
- 4 **Select the source USB flash drive and folder.**
- 5 **Select the desired file (.wav) on the USB flash drive to execute the Load operation.**

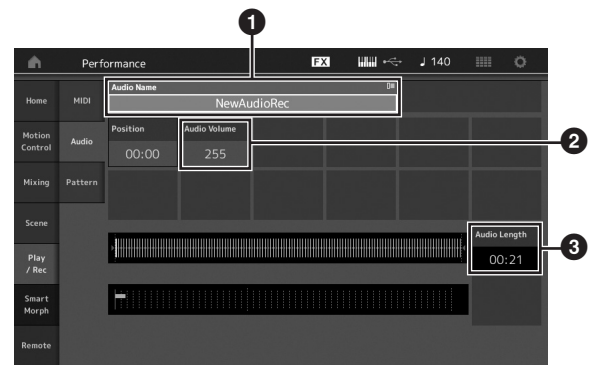

- 1 Audio name
- 2 Audio volume
- 3 Audio length

6 Press the [▶] (Play) button.

The audio file will begin playing.

7 Move the cursor to “Audio Volume” (2), and then adjust the playback volume by using the data dial.

8 Press the [■] (Stop) button to stop playback.

NOTE

Keep in mind that you can also play a selected Performance on the keyboard during audio playback.

Using as a Master Keyboard

The Master Keyboard function lets you assign up to eight separate Zones in each Performance for use as a master keyboard controller.

You can call up the settings for controlling an external MIDI device instantly anytime you need by combining with the Live Sets. Accordingly, you can change and control the connected external MIDI tone generator in sequence while performing live.

Making settings for use as a master keyboard—Zone

When you use the MODX+ as a master keyboard, you can divide the keyboard into a maximum of eight independent areas (called “Zones”). Different MIDI channels and different functions of the Knobs and Control Sliders can be assigned to each Zone. This makes it possible to control several Parts of the internal multi-timbral tone generator simultaneously by a single keyboard, or control Performances of an external MIDI instrument over several different channels in addition to the internal Performances of this synthesizer itself—letting you use the MODX+ to effectively do the work of several keyboards. You can set the parameters related to the eight Zones and store the settings.

First, set the MODX+ as a master keyboard by activating the Zone settings.

- 1 Press the [UTILITY] button to call up the Utility display.
- 2 Touch the [Settings] tab → [Advanced] tab at the left side of the screen.
- 3 Touch [Zone Master] to turn it on.

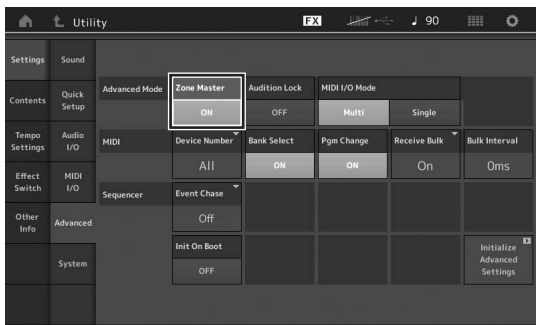

- 4 Press the [EXIT] button. This stores the setting and returns to the previous display.

Next, make settings according to the Master Keyboard (Zone) for each Performance.

- 1 Press the [PERFORMANCE (HOME)] button to call up the Performance Play display.
- 2 Move the cursor to the desired Part of the currently selected Performance and press the [EDIT] button to edit the Part.
- 3 Touch the [Part Settings] tab → [Zone Settings] tab at the left side of the screen.
- 4 Touch [Zone] to turn it on.
- 5 Set the Zone related parameters such as MIDI transmit channel and Note Limit.

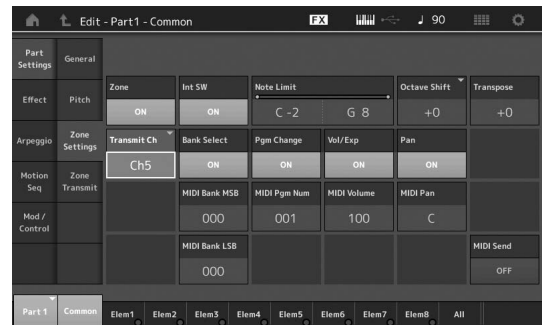

- 6 Touch the [Zone Transmit] tab to set the transmit switches as desired.



After completing these settings, press the [STORE] button to store the Performances.

For details about Zone settings, see the Reference Manual PDF document.

Connecting a Microphone or Audio Equipment

Playing the keyboard along with the sound input from the A/D INPUT [L/MONO]/[R] jacks

You can have the A/D input sound—such as your voice through a microphone, a CD player, or a synthesizer—assigned as an Audio Input Part. Various parameters such as volume, pan, and effects can be set to this Part and the sound is output together with the sound of your keyboard performance.

- 1 Make sure to turn off the power of this instrument and set the A/D INPUT [GAIN] knob to the minimum.**
- 2 Connect the audio equipment or the microphone to the A/D INPUT [L/MONO]/[R] jack(s) on the rear panel.**

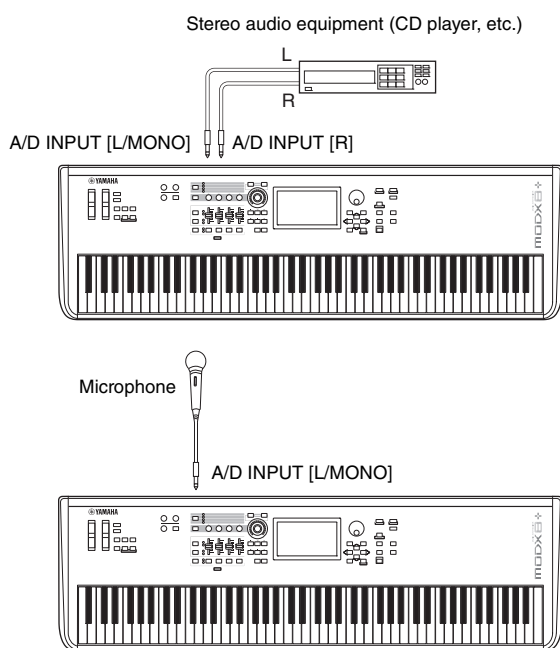

NOTE

A standard dynamic microphone is recommended. (This instrument does not support phantom-powered condenser microphones.)

- 3 Turn on the connected audio equipment, then turn on the MODX+.**
- 4 Press the [UTILITY] button to call up the Utility display, and touch the [Settings] tab → [Audio I/O] tab at the left side of the screen.**

- 5 Set the “Mic/Line” parameter according to the particular equipment connected to the A/D INPUT [L/MONO]/[R] jacks.**

When connecting equipment of low output level such as a microphone, set this parameter to “Mic.” When connecting equipment of high output level (such as a synthesizer keyboard, CD player, portable music player), set this parameter to “Line.”

- 6 Press the A/D INPUT [ON/OFF] button so that its lamp lights.**

This setting enables audio signals to be input from the connected audio device.

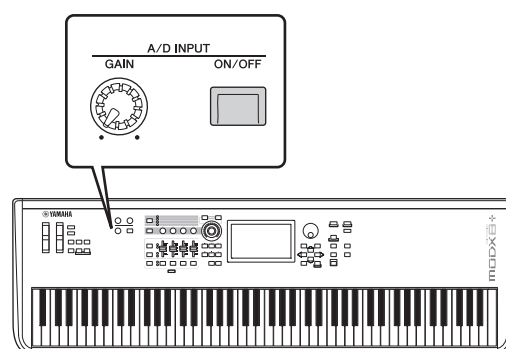

- 7 Adjust the input level by using the [GAIN] knob.**

NOTE

Adjust the input level with the [GAIN] knob so that the PEAK LED lights briefly only at the loudest input sounds.

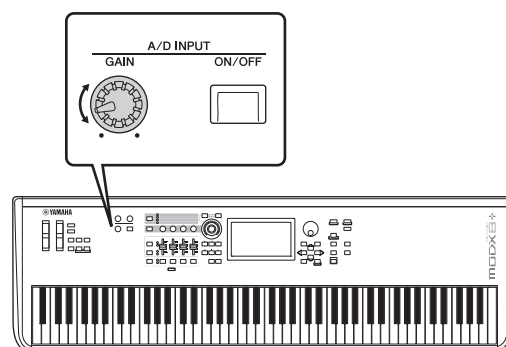

- 8 Press the [PERFORMANCE (HOME)] button, and then select the desired Performance.**

Play the keyboard while you sing into the microphone or play back the audio equipment.

Making Global System Settings

You can set various parameters in the Utility display. In particular, you can set the parameters that apply to the entire system of this instrument by touching the [Settings] tab. The changes you make in the Utility display are activated once you press the [EXIT] button to return to the original display. This section describes some useful functions related to the entire system settings.

Setting automatic power-on tasks

You can determine which display is automatically called up when power is turned on: the Live Set display or the Performance Play display.

- 1 Press the [UTILITY] button to call up the Utility display, then touch [Settings] tab → [System] tab.
- 2 In [Power on Mode], select “Live Set” (Live Set display) and the slot number, or “Perform” (Performance Play display) as the start-up display.



- 3 Press the [EXIT] button.
This stores the setting and returns to the previous display.

Setting button lamp behavior

You can control the dimming of the button lamps.

- 1 Press the [UTILITY] button to call up the Utility display, then touch [Settings] tab → [System] tab.
- 2 Set “Half Glow” to “Off,” “1/4,” or “1/2.”
When “Off” is selected, the dimming function is turned off.
When “1/4” is selected, the brightness of the button in the dimly lit condition is reduced to 25% of the fully lit condition. This lighting level is suitable for dark surroundings, such as a stage.
When “1/2” is selected, the brightness of the button in the dimly lit condition is reduced to 50% of the fully lit condition. This lighting level is useful in bright surroundings (such as outdoors) when it is hard to distinguish whether the button is dimly lit or off.
- 3 Press the [EXIT] button.
This stores the setting and returns to the previous display.

Turning various functions on/off

You can set various functions by touching the [System] tab on the Utility display.

Turning animation on/off

You can turn the animation of screen transition on/off as follows.

- 1 Press the [UTILITY] button to call up the Utility display, then touch [Settings] tab → [System] tab.
- 2 Select “ON” or “OFF” in “Animation” to turn the animation on or off.



- 3 Press the [EXIT] button.
This stores the setting and returns to the previous display.

Turning display blur effect on/off

When any display is selected, the display previously selected is blurred. You can turn the function on/off as follows.

- 1 Press the [UTILITY] button to call up the Utility display, then touch [Settings] tab → [System] tab.
- 2 Set “Blur” to “ON” or “OFF” to turn the blur effect on or off.
- 3 Press the [EXIT] button.
This stores the setting and returns to the previous display.

Turning the beep sound on/off

You can turn the beep sound (that confirms operations, menu/parameter selection, etc.) on/off as follows.

- 1 Press the [UTILITY] button to call up the Utility display, then touch [Settings] tab → [System] tab.
- 2 Set “Beep” to “ON” or “OFF” to turn the beep on or off.
- 3 Press the [EXIT] button.
This stores the setting and returns to the previous display.

Turning the flashing of the Super Knob on/off

In the default setting, the Super Knob flashes at the current beat. You can turn this flashing on/off as follows. When the function is turned off, the Super Knob remains lit continuously.

- 1 Press the [UTILITY] button to call up the Utility display, then touch [Settings] tab → [System] tab.
- 2 Select “ON” or “OFF” in “Knob Flash” to turn the flashing on or off.

Touch panel calibration

Calibration of the touch panel may be necessary if the touch panel seems occasionally unresponsive or the response is erratic.

- 1 Hold down the [UTILITY] button and press the [PART SELECT MUTE/SOLO] button.
The Utility display appears, with the [Calibrate Touch Panel] selected.
- 2 Press the [ENTER] button.
- 3 A white square appears. Touch the square to calibrate the touch panel, and continue with subsequent white squares until the operation is finished.

NOTE

Alternately, you can touch [UTILITY] → [Settings] → [System] to call up the System setting display and touch [Calibrate Touch Panel].

Changing the Master Tuning

You can adjust the tuning of the MODX+. This is useful when playing in an ensemble to match the pitch of other instruments which cannot be easily tuned (such as a piano).

- 1 Press the [UTILITY] button to call up the Utility display, then touch [Settings] tab → [Sound] tab.

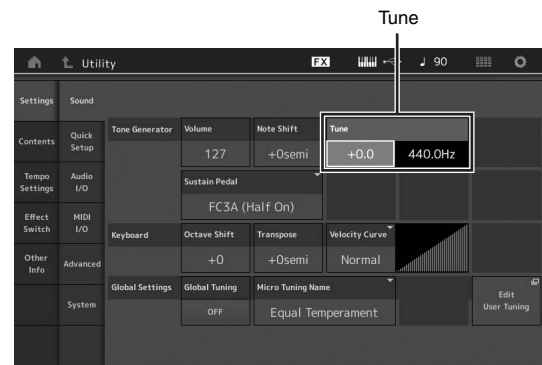

- 2 Select “Tune” and change the parameter by using the Data dial.

In this example, we'll change the value from “440 Hz” to “442 Hz.” Since the Tune parameter is actually adjusted in cents (1 cent = 1/100th of a semitone), the corresponding value in Hertz is shown at right. Turn the data dial to change the value to “+8.0.” Use a tuner for the more accurate tuning as necessary.

- 3 Press the [EXIT] button.

This stores the setting and returns to the previous display.

Changing the Velocity Curve

These five curves determine how the actual velocity will be generated and transmitted according to the velocity (strength) with which you play notes on the keyboard. The graph shown in the display indicates the velocity response curve. (The horizontal line represents the received velocity values (strength of your playing), while the vertical line represents the actual velocity values transmitted to the internal/external tone generators.)

- 1 Press the [UTILITY] button to call up the Utility display, then touch [Settings] tab → [Sound] tab.

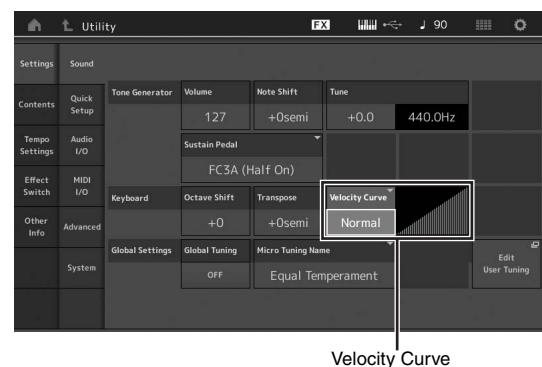

2 Select “Velocity Curve” and change the curve setting as desired, from the pop-up menu at the left of the display.

Normal	This linear “curve” produces one-to-one correspondence between the strength of your keyboard playing (velocity) and the actual sound change.
Soft	This curve provides increased response, especially for lower velocities.
Hard	This curve provides increased response, especially for higher velocities.
Wide	This curve accentuates your playing strength by producing lower velocities in response to softer playing and louder velocities in response to harder playing. As such, you can use this setting to expand your dynamic range.
Fixed	This setting produces the same amount of sound change (set in Fixed Velocity below), no matter what your playing strength.

When the parameter of the Velocity Curve is set to “Fixed”

The velocity of the note you play is fixed at the value set here.

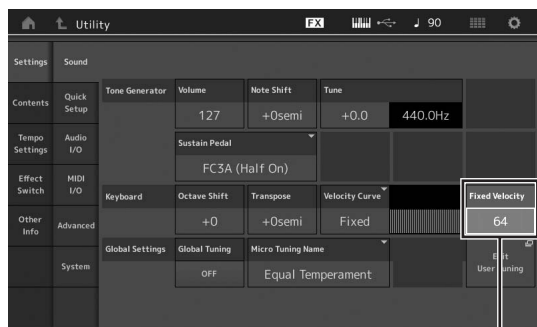

Setting the Fixed Velocity value

3 Press the [EXIT] button.

This stores the setting and returns to the previous display.

Setting Local Control on/off

Local Control is usually set to on; however, in some cases (when using with a computer and sequencer program), you may want to turn it off so that the keyboard does not play the internal Parts, but the appropriate MIDI information is still transmitted via the MIDI OUT terminal when notes are played on the keyboard. Also, the input MIDI information is appropriately processed in this instrument.

1 Press the [UTILITY] button to call up the Utility display and touch the [Settings] tab at the left side of the screen → [MIDI I/O] tab.

2 Set “Local Control” to either “ON” or “OFF.”

3 Press the [EXIT] button.

This stores the setting and returns to the previous display.

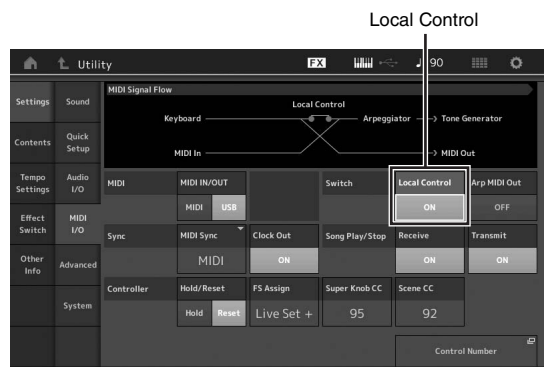

Changing the font size of the Live Set

If the characters on the Live Set display or the Category Search display are small and difficult to read, you can increase the size of the displayed characters.

The setting display is called up via the [Utility] button → [Settings] tab → [System] tab → “Live Set Font.”

For details, refer to the Reference Manual.

Connecting External MIDI Instruments

You can connect to an external MIDI device using a commercially available MIDI cable or USB cable. This allows you to control an external MIDI device from MODX+, or play the tone generator of the MODX+ with an external MIDI keyboard or sequencer. This section describes the settings required to use the device as intended while connecting an external MIDI device. For details on specific connection examples, refer to the Reference Manual.

Connecting to an external MIDI device with the MIDI [IN], [OUT] terminals

When connecting to an external MIDI device using the MIDI [IN] and [OUT] terminals, the following two settings related to MIDI transmission/reception must be set correctly to operate the device as intended.

MIDI IN/OUT

Determines whether MIDI communication with an external device is handled through the MIDI [IN], [OUT] terminals or the [USB TO HOST] terminal.

The setting display is called up by the [UTILITY] button → [Settings] tab → [MIDI I/O] tab → "MIDI IN/OUT."

MIDI	For using the MIDI [IN], [OUT] terminals.
USB	For using the [USB TO HOST] terminal.

NOTE

For an external MIDI device connected via the [USB TO DEVICE] terminal, MIDI communication is always possible regardless of this setting.

MIDI I/O Mode

Determines the rules by which channels transmit the data of each Part and which Part receives the data received by each channel, when communicating with an external MIDI device. The setting display is called up by the [UTILITY] button → [Settings] tab → [Advanced] tab → "MIDI I/O Mode."

Multi	This is one-to-one correspondence between each Part and each channel. For example, Part 1 data is sent and received on channel 1 and Part 16 data is sent and received on channel 16.
Single	Data of all Parts with Keyboard Control set to on is sent and received on one specified channel. Data of Parts with Keyboard Control set to off is not sent or received. To specify which channel is used to send and receive data, set the "MIDI I/O Ch."
Hybrid	Data for all Parts with Keyboard Control set to on is sent and received in the same way as when "Single" is set. Data on the Part where Keyboard Control set to off is sent and received in the same way as when "Multi" is set.

Connecting to an external MIDI device with the [USB TO DEVICE] terminal

You can connect an external MIDI device (such as a MIDI keyboard) to the [USB TO DEVICE] terminal and treat it as if it were a keyboard built into the MODX+ itself.

MIDI devices available

- **USB class compliant MIDI devices**
USB MIDI keyboard, etc.
- **Yamaha MIDI devices whose compatibility has been confirmed**
CP1, CP4/40 STAGE, CP88/73, MODX, MONTAGE, MOTIF XF, MOXF, MX, reface, YC

NOTICE

The rating of the [USB TO DEVICE] terminal is a maximum of 5V/500mA. Do not connect USB devices having a rating above this, since this can cause damage to the instrument itself.

Special notes concerning MIDI communication

MIDI communication with a device connected via the [USB TO DEVICE] terminal follows special rules that allow the device to behave like a built-in keyboard.

- MIDI communication is one-way only (sent from the external MIDI device and received by the MODX+).
- All MIDI data is received regardless of the "MIDI IN/OUT," "MIDI I/O Mode," and "MIDI I/O Ch" settings.
- For Parts with Keyboard Control set to on, data received on all corresponding channels is shared. For example, when Keyboard Control for Parts 1 to 3 are set to on, data received from any of channels 1 to 3 will be delivered to all Parts 1 to 3.
- Each Part with Keyboard Control set to off receives the data of only the corresponding channel for the Part.
- Only when "MIDI I/O Mode" is "Single," some particular Control Change messages sent to the channel specified by "MIDI I/O Ch" setting are not relayed to each Part but be received as Common parameters. In this regard, this is the same way as communication via the MIDI [IN], [OUT] terminals and the [USB TO HOST] terminal. For details on the applicable Control Change messages, refer to the "MIDI I/O Mode" section of the Reference Manual.

Using a Connected Computer

By connecting the MODX+ to your computer, you can use a DAW or sequence software on the computer to create your own original songs.

NOTE

The acronym DAW (digital audio workstation) refers to music software for recording, editing and mixing audio and MIDI data. The main DAW applications are Steinberg Cubase, Ableton Live, and Apple Logic.

Connecting to a computer

A USB cable and the Yamaha Steinberg USB Driver are necessary to connect the MODX+ to the computer. Follow the instructions below. Note that both audio data and MIDI data can be transmitted through a USB cable.

1 Download the latest Yamaha Steinberg USB Driver from our website.

After clicking the Download button, extract the compressed file.

<https://download.yamaha.com/>

After accessing the Support website (and clicking on "Firmware/Software"), enter the appropriate model name.

NOTE

- Information on system requirements is also available at the above website.
- The Yamaha Steinberg USB Driver may be revised and updated without prior notice. Make sure to check and download the latest version from the above site.

2 Install the Yamaha Steinberg USB Driver to the computer.

For instructions on installing, refer to the online Installation Guide included in the downloaded file package. When connecting this instrument to a computer, connect the USB cable to the [USB TO HOST] terminal of this instrument and the USB terminal of the computer as shown below.

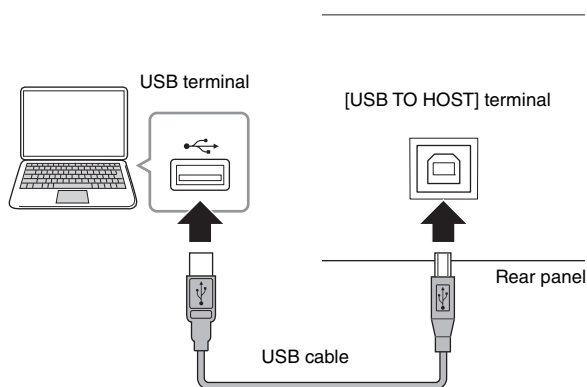

3 Press the [UTILITY] button to call up the Utility display.

4 Touch [Settings] tab → [MIDI I/O] tab at the left side of the display.

5 Set "MIDI IN/OUT" to "USB."

Make sure that the [USB TO HOST] terminal of this instrument is enabled.

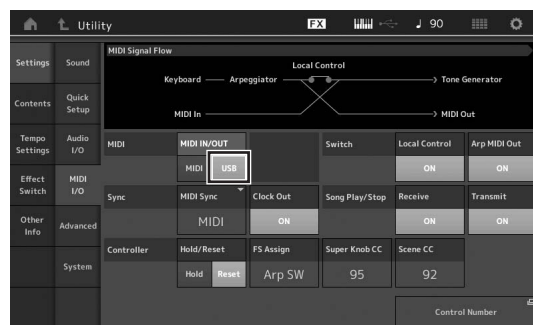

6 Set the input and output settings for audio data as desired to suit your personal preferences.

The change can be made from [UTILITY] → [Settings] → [Audio I/O].

Using the Quick Setup function to change parameters related to audio and MIDI data, lets you instantly reconfigure the MODX+ for different computer/sequencer related applications by simply calling up specially programmed presets.

To do this, touch [Settings] tab → [Quick Setup] tab at the left side of the display to call up the Quick Setup display.

Touch [Store Current Settings] to store the desired setting in any of the 1 to 3 Quick Setups.

NOTE

For details on the parameters available for setting with the Quick Setup function, see the Reference Manual PDF document.

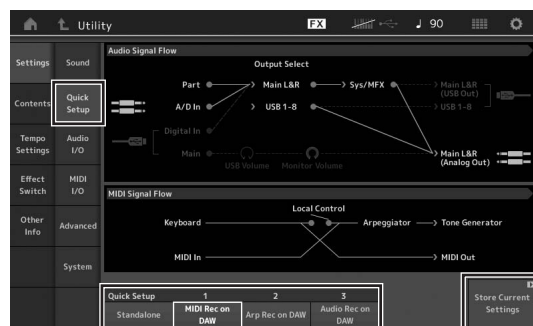

Quick Setups 1 to 3

Precautions when using the [USB TO HOST] terminal

When connecting the computer to the [USB TO HOST] terminal, make sure to observe the following points to avoid freezing the computer and corrupting or losing the data.

NOTICE

- Use an AB type USB cable. USB 3.0 cables cannot be used.
- Execute the following before turning the power to the instrument on/off or plugging/unplugging the USB cable to/from the [USB TO HOST] terminal.
 - Quit any open application software on the computer.
 - Make sure that data is not being transmitted from the instrument. (Data is transmitted only by playing notes on the keyboard or playing back a song.)
- While the computer is connected to the instrument, you should wait for six seconds or more between these operations: (1) when turning the power of the instrument off then on again, or (2) when alternately connecting/disconnecting the USB cable.

If the computer or the instrument freezes, restart the application software or the computer OS, or turn the power to the instrument off then on again.

Audio channels

The audio signals of the MODX+ can be output to the [USB TO HOST] terminal and the OUTPUT [L/MONO]/[R] jacks. When connecting to a computer, use the [USB TO HOST] terminal. In this case, up to 10 audio channels (5 stereo channels) are available. The output-to-channel assignments are made as follows: [EDIT] → [Part Settings] → "Part Output" in the [General] display.

The audio signals of the MODX+ can be input from the [USB TO HOST] terminal and the A/D INPUT [L/MONO]/[R] jacks.

Up to four channels (two stereo channels) of audio can be input to the [USB TO HOST] terminal. Set the output level in the Mixing display or the Performance edit display. The signals are output to the OUTPUT [L/MONO]/[R] jacks (two channels.) Also, up to two audio channels (one stereo channel) can be input to the A/D INPUT [L/MONO]/[R] jacks. The signal is sent to the A/D input part of the MODX+. For more details, see the Reference Manual PDF document.

Usage of each MIDI port

When this instrument is connected to a computer with the [USB TO HOST] terminal, the computer recognizes three MIDI ports for different usages.

For the MODX+, the usage of each port is as follows. Select the appropriate port on the computer side, according to the application.

Port 1: For communication between the tone generator section of this instrument and the computer

If you want to play the tone generator of this instrument from your computer, or if you want your computer to receive performance information from this instrument, select Port 1 on your computer.

Port 2: For DAW remote function

If you want to use this instrument to remotely control your DAW software, select Port 2 on your computer. For details on how to set and use the DAW remote function, refer to the Reference Manual.

Port 3: For using this instrument as a USB-MIDI interface

If you want to connect an external MIDI device that does not have a USB terminal to a computer via the MIDI [IN]/[OUT] terminals of this instrument, select Port 3 on the computer.

When "MIDI IN/OUT" (page 54) is set to "USB," the MIDI [IN]/[OUT] terminals of this instrument are directly connected to Port 3, and are disconnected from the tone generator section.

NOTE

- These Ports are only valid when "MIDI IN/OUT" (page 54) is set to "USB."
- Each Port can handle 16 channels of MIDI data.

Creating a Song with a computer

By using the MODX+ with DAW software on a computer connected to the MODX+, you can take advantage of the following functions and applications.

- MIDI recording and audio recording of your MODX+ performance to the DAW software.
- Playing back a song from the DAW software by using the MODX+ tone generator.

This section contains an overview on how to use DAW software on the computer with the MODX+ after connecting (page 55).

Recording your performance on the MODX+ to computer as MIDI data (no Arpeggio playback recorded)

In this method, you record your performance on the MODX+ to DAW simply as MIDI data. Keep in mind that Arpeggio playback cannot be recorded.

Setting up the MODX+

- 1 Press the [UTILITY] button to call up the Utility display.
- 2 Touch [Settings] tab → [Quick Setup] tab at the left side of the display to call up the Quick Setup display.
- 3 Select “1 (MIDI Rec on DAW)” of “Quick Setup.”

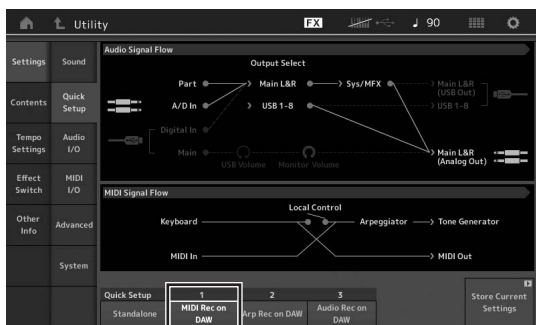

- 4 Press the [EXIT] button to select the Performance you want to record.

Setting up the DAW software

- 1 Set MIDI Thru to “on” on the DAW software.
By setting MIDI Thru to “on,” the MIDI data generated by playing the keyboard and transmitted to the computer will be returned back to the MODX+. As shown in the example below, the MIDI data transmitted from the MODX+ then recorded to the computer via MIDI channel 1 will be returned back from the computer to the MODX+ via MIDI channel 3 according to the setting of the recording Track. As a result, the tone generator of the

MODX+ will sound the MIDI data generated by playing the keyboard as MIDI data from channel 3.

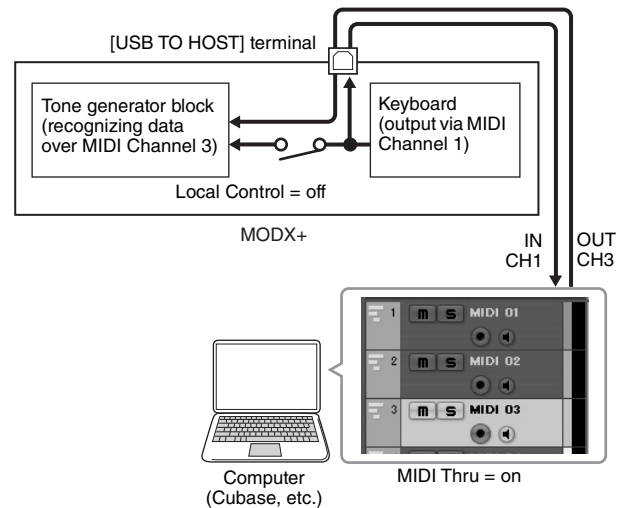

- 2 Record your MODX+ performance on the DAW software.

Recording your performance on the MODX+ to computer as MIDI data (with Arpeggio playback recorded)

In this method you can record Arpeggio playback on the MODX+ to DAW as MIDI data.

Setting up the MODX+

- 1 Press the [UTILITY] button to call up the Utility display.
- 2 Touch [Settings] tab → [Quick Setup] tab at the left side of the display to call up the Quick Setup display.
- 3 Select “2 (Arp Rec on DAW)” of “Quick Setup.”

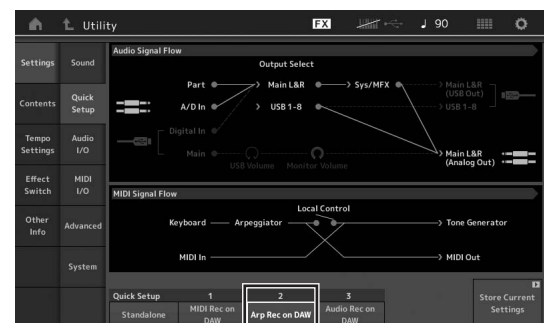

- 4 Press the [EXIT] button to select the Performance you want to record.

Setting up the DAW software

Follow the same operations in “Recording your performance on the MODX+ to computer as MIDI data (no Arpeggio playback recorded).”

Song playback from a computer using the MODX+ as a tone generator

The instructions below show how to use this instrument as a MIDI tone generator. In this case, actual MIDI sequence data is transmitted from DAW software on the computer, letting you take advantage of the dynamic sounds of the MODX+, while giving you the added benefit of saving processing power on your computer by avoiding the use of software synths.

Setting up the MODX+

- 1 Select the Performance to be edited.**
- 2 Touch the [Mixing] tab on the Performance Play display to call up the Mixing display.**
- 3 Set up the Mixing for Parts 1–16 as necessary.**

Setting up the DAW software

- 1 Set the MIDI output port of the Tracks for playing the MODX+ to Port 1 of the MODX+.**
- 2 Enter the MIDI data to each Track of the DAW software on the computer.**

The tone generator settings of the part corresponding to the MIDI Track will be set in the Mixing display on the MODX+.

Controlling your DAW software from the MODX+ (DAW remote function)

When the MODX+ is connected to your computer by a USB cable, you can use the MODX+ to remotely control the DAW software on your computer.

For details on how to set and use, refer to the Reference Manual.

MEMO



Saving/Loading Data

The Utility display provides tools for transferring the entire system setting and data (such as Performances and Live Sets) between the MODX+ and a USB flash drive connected to the [USB TO DEVICE] terminal. This section explains how to save/load all the data on the user memory of this instrument as a “User” file.

Saving the settings to a USB flash drive

- 1 Connect a USB flash drive to the [USB TO DEVICE] terminal of this instrument.
- 2 Press the [UTILITY] button to call up the Utility display, and then touch the [Contents] tab → [Store/Save] tab in the left of the display.
- 3 Set “Content Type” to “User File.”

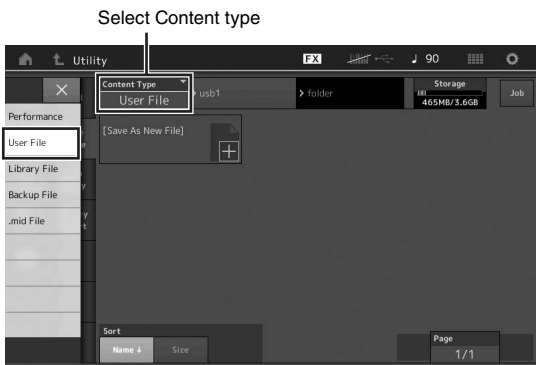

- 4 Select the desired directory of the USB flash drive.

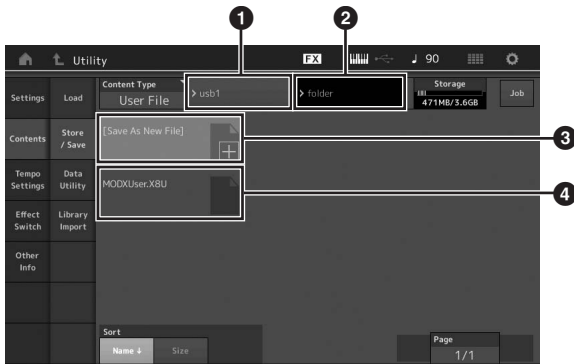

- 1 Parent folder
- 2 Store-destination folder in the USB flash drive
- 3 New store destination
- 4 Existing files

- 5 Touch “+” in [Save As New File].

NOTE

To overwrite the existing file, touch the file name.

- 6 The Text input display appears. Input the file name to be stored.

For detailed instructions on entering a name, see “Naming (inputting characters)” in “Basic Operation and Displays” (page 21).

- 7 Touch [Done] on the Text input display to actually execute the Store operation.

NOTE

To overwrite the existing file, select “YES” on the display which prompts you for confirmation.

Loading the settings from a USB flash drive

NOTICE

The Load operation overwrites the existing data in this instrument. Important data should always be saved to a USB flash drive connected to the [USB TO DEVICE] terminal.

- 1 Connect a USB flash drive to the [USB TO DEVICE] terminal of this instrument.
- 2 Press the [UTILITY] button to call up the Utility display, and then touch [Contents] tab → [Load] tab at the left side of the display.
- 3 Set “Content Type” to “User File.”
- 4 Select the desired folder of the USB flash drive.
- 5 Select the file (extension: .X8U) of the memory to execute the Load operation.

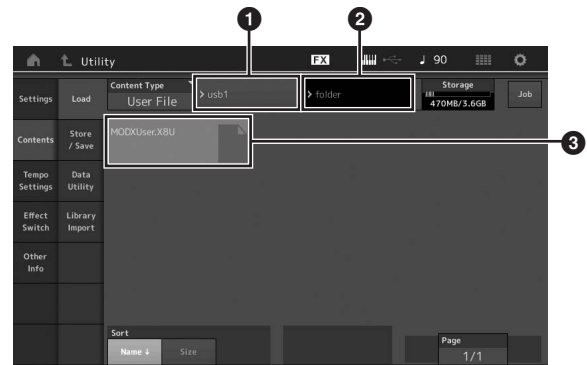

- 1 Source USB flash drive
- 2 Source folder in the USB flash drive
- 3 Existing files

Precautions when using the [USB TO DEVICE] terminal

This instrument features a built-in [USB TO DEVICE] terminal. When connecting a USB device to the terminal, be sure to handle the USB device with care. Follow the important precautions below.

NOTE

For more information about the handling of USB devices, refer to the owner's manual of the USB device.

Compatible USB devices

- USB flash drive (*1)
- USB class compliant MIDI devices (*2)
- Yamaha MIDI devices whose compatibility has been confirmed (*2)

Other USB devices such as a USB hub, computer keyboard or mouse cannot be used.

Although USB devices 1.1 to 3.0 can be used on this instrument, the amount of time for saving to or loading from the USB device may differ depending on the type of data or the status of the instrument.

*1) The instrument does not necessarily support all commercially available USB flash drives. Also, Yamaha cannot guarantee operation of USB flash drives that you purchase. Before purchasing a USB flash drive for use with this instrument, confirm the compatibility of the device with compatible device list on the following web page:

<https://download.yamaha.com/>

After accessing the Support website and clicking on "Documents and Data," enter the model name of the instrument and click "Search."

*2) For details on the MIDI devices that can be used and related settings and how the devices work when connected, refer to the "Connecting External MIDI Instruments" (page 54).

NOTICE

The rating of the [USB TO DEVICE] terminal is a maximum of 5V/500mA. Do not connect USB devices having a rating above this, since this can cause damage to the instrument itself.

Connecting a USB device

When connecting a USB device to the [USB TO DEVICE] terminal, make sure that the connector on the device is appropriate and that it is connected in the proper direction.

NOTICE

- **Avoid connecting or disconnecting the USB device during playback/recording and file management operations (such as Save, Copy, Delete and Format), or when accessing the USB device. Failure to observe this may result in "freezing" of the operation of the instrument or corruption of the USB device and the data.**
- **When connecting then disconnecting the USB device (and vice versa), make sure to wait a few seconds between the two operations.**

Using USB flash drives

By connecting the instrument to a USB flash drive, you can save data you've created to the connected device, as well as read data from the connected device.

Maximum number of USB flash drives that can be used

Only one USB flash drive can be connected to the [USB TO DEVICE] terminal.

Formatting USB flash drive

You should format the USB flash drive only with this instrument (page 61). A USB flash drive formatted on another device may not operate properly.

NOTICE

The format operation overwrites any previously existing data. Make sure that the USB flash drive you are formatting does not contain important data.

NOTE

For details on how to format the USB flash drive, see the Reference Manual PDF document.

To protect your data (write-protect)

To prevent important data from being inadvertently erased, apply the write-protect provided with each USB flash drive. If you are saving data to the USB flash drive, make sure to disable write-protect.

Turning off the instrument

When turning off the instrument, make sure that the instrument is NOT accessing the USB flash drive by playback/recording or file management (such as during Save, Copy, Delete and Format operations). Failure to do so may corrupt the USB flash drive and the data.

Shift Function List

Some of the important functions and operations on the instrument can be executed with convenient panel control shortcuts. Simply hold down the [SHIFT] button and press the indicated button (as described below).

Operation	Function
[SHIFT] + KNOB POSITION [1]	Stores Assign 1–8 assigned to Knobs in Value 1.
[SHIFT] + KNOB POSITION [2]	Stores Assign 1–8 assigned to Knobs in Value 2.
[SHIFT] + OCTAVE [-]	Decreases the transpose value by 1.
[SHIFT] + OCTAVE [+]	Increases the transpose value by 1.
[SHIFT] + OCTAVE [-] + OCTAVE [+]	Resets the transpose value to 0.
[SHIFT] + [DEC/NO]	Decreases the selected parameter value by 10. In the Live Set display, this operation calls up the previous page.
[SHIFT] + [INC/YES]	Increases the selected parameter value by 10. In the Live Set display, this operation calls up the next page.
[SHIFT] + [ENTER]	Calls up the Tempo Settings display.
[SHIFT] + [PERFORMANCE (HOME)]	Calls up the Overview display.
[SHIFT] + [LIVE SET]	Calls up the Live Set Register display.
[SHIFT] + [UTILITY]	Calls up the Quick Setup display.
[SHIFT] + [CATEGORY]	Calls up the Part Category Search display for the currently selected Part.
[SHIFT] + Slider Select [1–4] [5–8]	Selects Part 9 or Part 13 when the Slider Function [PART]/[ELEMENT/OPERATOR] button is set to "PART."
[SHIFT] + [EDIT]	Opens the Copy/Exchange dialog.
[SHIFT] + SCENE [1]–[8]	Stores SCENE 1–8 in SCENE [1]–[8] buttons.
[UTILITY] + [PART SELECT MUTE/SOLO]	Calls up the Touch Panel Calibration Setting display.
[SHIFT] + [AUDITION]	Panel lock/unlock if the Performance Play display or Live Set display is shown.
[SHIFT] + cursor buttons	Changes categories on the Category Search display (page 24): <ul style="list-style-type: none"> • [SHIFT] + Left/Right: Changes main category to next/previous. • [SHIFT] + Left + Right: Sets main category to "All." • [SHIFT] + Up/Down: Changes sub category to next/previous. • [SHIFT] + Up + Down: Sets sub category to "All."

Display Messages

LCD indication	Description
** will be deleted.	This message appears when the specified operation you are about to execute will cause the specified data to be deleted.
** will be overwritten.	This message appears when a file/folder having the same name as the one you are about to save already exists.
Activate the source controller to assign.	You can assign the parameter to the controller you are about to activate.
Advanced settings will be initialized.	All settings executed in [Advanced] tab will be initialized.
All data and libraries will be initialized. Unsaved user data will be lost.	All data and libraries will be initialized. Unsaved user data will be lost.
All data is initialized upon power-on.	All data is initialized upon power-on.
All settings will be initialized. User data is kept.	All settings will be initialized. User data is kept.
All sound will be stopped during optimization.	This message appears before the internal memory is restored. All sound will be stopped during the optimization.
All user data will be initialized. Unsaved user data will be lost.	All user data will be initialized. Unsaved user data will be lost.
Are you sure?	Confirms whether you want to execute a specified operation or not.
Arpeggio full.	Appears when there are no more Arpeggio Part Switches to turn ON.
Assignable Knob Full.	Appears when all of the Assignable Knobs are in use and no more Super Knob settings can be added.
Audio Rec stopped due to lack of memory space.	The USB flash drive is full and no more audio recording data can be saved. Use a new USB flash drive, or make space by erasing unwanted data from the USB flash drive.
Auto power off disabled.	This message appears before Auto Power Off is disabled.
Bulk data protected.	Bulk data cannot be received because of the setting.
Can't process.	The MODX+ cannot process a requested operation.
Completed.	The specified load, save, format, or other Job has been completed.
Connecting to USB device...	Currently recognizing the USB flash drive connected to the [USB TO DEVICE] terminal.
Control Assign Full.	All Control Assigns are in use.
Copy protected.	You have attempted to export or save a copy-protected digital audio source.
Current user data will be overwritten by **.	This message appears when saving a file, and user data under that name already exists.
Data memory full.	The internal memory is full, preventing storing of the recorded data in the Library.
Device number is off.	Bulk data cannot be transmitted/received since the device number is off.
Device number mismatch.	Bulk data cannot be transmitted/received since the device numbers do not match.
File is not found.	The specified file was not found during a Load operation.
File or folder already exists.	A file/folder having the same name as the one you are about to save already exists.
File or folder path is too long.	The file or folder you tried to access cannot be accessed because the maximum amount of characters indicating the path has been exceeded.
Folder is not empty.	You have attempted to delete a folder that contains data.
Illegal bulk data.	An error occurred while receiving a Bulk data or Bulk Request message.
Illegal file name.	The specified file name is invalid. Try entering a different name.
Illegal file.	The specified file is unusable by this synthesizer or cannot be loaded.
Keybank full.	The maximum overall number of Key Banks has been exceeded when executing a Load operation.

LCD indication	Description
Library full.	The maximum overall number of Libraries has been exceeded when executing the related operations.
MIDI buffer full.	Failed to process the MIDI data because too much data was received at one time.
MIDI checksum error.	An error occurred when receiving bulk data.
Modified: Common AsgnKnob?	Appears when the Control Assign settings for Common/Audio Edit are automatically added or modified when you add or modify the settings for the Assignable knobs that are associated to the Super Knob in the Control Assign display for the Part Edit.
No data.	This message appears when the selected track or range contains no data. Select an appropriate track or range.
No read/write authority to the file.	Indicates that you do not have the authority to read/write the file.
Now initializing all data...	Indicates this synthesizer is restoring the factory-programmed settings.
Now initializing...	Indicates that the specified data is being initialized.
Now loading...	Indicates that a file is being loaded.
Now receiving MIDI bulk data...	Indicates this synthesizer is receiving MIDI bulk data.
Now saving...	Indicates that a file is being saved.
Now transmitting MIDI bulk data...	Indicates this synthesizer is transmitting MIDI bulk data.
Part Full.	All Parts are in use.
Please connect USB device.	Connect the USB device to the [USB TO DEVICE] terminal for audio recording.
Please keep power on.	The data is being written to Flash ROM. Never attempt to turn off the power while data is being written to Flash ROM. Turning the power off while this message is shown results in loss of all user data and may cause the system to freeze (due to corruption of data in the Flash ROM). This may also result in the MODX+ being unable to properly start up the next time the power is turned on.
Please reboot to enable the new Audio I/O Mode.	Please reboot this synthesizer to activate the change of the input/output settings for audio data.
Please reboot to maintain internal memory.	Please reboot this synthesizer to restore the internal memory.
Please stop audio play/rec.	The operation you have attempted to execute cannot be done during audio recording or playback.
Please stop sequencer.	The operation you have attempted to execute cannot be done during Song playback.
Please wait...	Indicates this synthesizer is executing the specified operation.
Recall latest edits.	If you are editing a Performance and select a different Performance without storing your edited one, all the edits you've made will be erased. If this happens, you can use Recall to restore the Performance with your latest edits intact.
Redo last recording.	Confirms whether you want to redo the operation you have undone.
Sample is protected.	The sample data cannot be overwritten.
Sample is too long.	The Sample size is too large and the Load operation cannot be executed.
Sample memory full.	The Sample memory is full and further Load operations cannot be executed.
Scene stored.	The Scene has been stored to one of the [SCENE] buttons.
Song data overload.	The Song size is too large for playback.
Song full.	The maximum overall number of Songs has been exceeded when executing the related operations.
Touch the white square.	This message appears when you need to touch the displayed white rectangle during touch panel calibration.
Turn on Memory Switch to memorize ** into this scene.	When the [Memory] (Memory Switch) is turned on for the function, the corresponding function information is automatically stored in the currently selected [SCENE] button.
Undo last recording.	Confirms whether you want to undo the most recent recording.
Unsupported USB device.	This message appears when an unsupported USB device has been connected.
USB connection terminated.	A break in the connection with the USB flash drive has occurred because of an abnormal electric current. Disconnect the USB flash drive from the [USB TO DEVICE] terminal, and then press any of the panel buttons.

LCD indication	Description
USB device is full.	The USB flash drive is full and no more data can be saved. Use a new USB flash drive, or make space by erasing unwanted data from the storage device.
USB device is write-protected.	This message appears when you have attempted to write to a protected USB flash drive.
USB device read/write error.	An error occurred while reading or writing to/from a USB flash drive.
USB device will be formatted.	This message appears before the USB device is formatted.
Waveform full.	The maximum overall number of Waveforms has been exceeded when executing the related operations.

Troubleshooting

No sound? Wrong sound? When a problem like this occurs, please check the following points before assuming that the product is faulty. Many problems can be solved by executing Data Initialization (page 19), after backing up your data to a USB flash drive (page 60). If the problem persists, consult your Yamaha dealer.

Touch panel does not respond correctly.

- Is the point you touch on the touch panel lined up properly with the target item in the display underneath?
Calibrate the touch panel.

[UTILITY] + [PART SELECT MUTE/SOLO] → [ENTER]

[UTILITY] → [Settings] → [System] → [Calibrate Touch Panel]

No Sound.

- Are all sliders set to appropriate levels (other than zero or minimum)?
- Is the MODX+ properly connected to related external equipment (e.g., amplifier, speaker, headphones) via audio cables?
Since the MODX+ has no built-in speakers, you will need an external audio system or a set of stereo headphones to properly monitor it (page 18).
- Is the power of this synthesizer and any external equipment connected to this synthesizer turned on?
- Have you made all the appropriate level settings—including the Master Volume on this synthesizer and the volume settings on any connected external equipment?
When the Foot Controller is connected to the [FOOT CONTROLLER] jack, press the Foot Controller down.
- Is the Local Control parameter set to off?
When the Local Control parameter is set to off, no sound is produced even if you play the keyboard.

[UTILITY] → [Settings] → [MIDI I/O] → "Local Control"

- Is a blank Part selected?
If so, assign any sound to the Part or select another Part.

- Is the Mute switch for each Part turned on?
When the Mute switch is turned on, no sound is produced even if you play the keyboard.

[PERFORMANCE (HOME)] → Part "Mute"

[PART SELECT MUTE/SOLO] → "Mute" → Part selection

- Is the Keyboard Control of each Part turned off?

[PERFORMANCE (HOME)] → Part "Kbd Ctrl"

- Is the "Arp Play Only" parameter of each Part turned on?
When this parameter is turned on, the corresponding Part produces sound only via Arpeggio playback.

[PERFORMANCE (HOME)] → Part selection → [EDIT] → [Part Settings] → [General] → "Arp Play Only"

[PERFORMANCE (HOME)] → Part selection → [EDIT] → [Arpeggio] → [Common] → "Arp Play Only"

- Are the MIDI volume or MIDI expression settings too low when using the external controller?
- Are the effect and filter settings appropriate?
If you are using a filter, try changing the cutoff frequency. Some cutoff settings may filter out all of the sound.

[PERFORMANCE (HOME)] → [EDIT] → [Effect]

[PERFORMANCE (HOME)] → Part selection → [EDIT] → [Effect]

- In case of Normal Part (AWM2) and Drum Part

[PERFORMANCE (HOME)] → Part selection → [EDIT] → Element/Key selection → [Filter]

- In case of Normal Part (FM-X)

[PERFORMANCE (HOME)] → Part selection → [EDIT] → Operator selection → [Pitch/Filter]

- Is "Vocoder" selected as the Insertion Effect Type of the Part?
If so, set the parameters related to the A/D INPUT [L/MONO]/[R] jacks to the appropriate values then play the keyboard while inputting your voice into the microphone connected to the MODX+. Check whether or not the A/D INPUT [GAIN] Knob on the rear panel is set to the minimum position.

[EDIT] → Part selection → Element/Key/Operator [Common] → [Effect] → [Routing]

- Are the volume or expression settings too low?

[UTILITY] → [Settings] → [Sound] → Tone Generator "Volume"

[EDIT] → [General] → "Volume"

[EDIT] → Part selection → Element/Key/Operator [Common] → [Part Settings] → [General] → "Volume"

[EDIT] → Part selection → Element/Key/Operator [Common] → [Part Settings] → [General] → "Dry Level"

- In case of Normal Part (AWM2) and Drum Part

[EDIT] → Part selection → Element/Key selection → [Amplitude] → [Level/Pan] → "Level"

- In case of Normal Part (FM-X)

[EDIT] → Part selection → Operator selection → [Level] → "Level"

- Are the parameter settings such as Element Switch, Note Limit, Velocity Limit, and Velocity Offset appropriate?

- In case of Normal Part (AWM2) and Drum Part

[EDIT] → Part selection → Element/Key/Operator [Common] → [Part Settings] → [General]

[EDIT] → Part selection → Element/Key selection → [Osc/Tune]

- In case of Normal Part (FM-X)

[EDIT] → Part selection → Element/Key/Operator [Common] → [Part Settings] → [General]

- Is the Mute switch for each Element/Operator of Part turned on?

[EDIT] → Part selection → Mute Switch of each Element/Operator

- In case of Normal Part (FM-X), is the Carrier Level is set to "0"?

[EDIT] → Part selection → Operator selection → [Level] → "Level"

- Is the output parameter of each Part turned off?

[EDIT] → Part selection → Element/Key/Operator [Common] → [Part Settings] → [General] → "Part Output"

No sound from the A/D INPUT jacks.

- Is the switch of the microphone turned on?
- Check the microphone type. Make sure to use a dynamic microphone.
- Is the cable between the microphone or audio equipment and this instrument properly connected?
- Is the A/D INPUT [GAIN] knob turned to the minimum?
- Is the A/D INPUT [ON/OFF] button turned on?
- Check whether or not the connection status of the A/D INPUT [L/MONO]/[R] matches the "Mono/Stereo" parameter.

[EDIT] → [Audio In] → [Mixing] → A/D In "Input Mode"

- Check whether or not the "Mic/Line" parameter is set to the appropriate value.

When the output level of the connected equipment (such as a microphone) is low, set this parameter to "Mic." When the output level of the connected equipment (such as a synthesizer keyboard, CD player) is high, set this parameter to "Line."

[UTILITY] → [Settings] → [Audio I/O] → "A/D Input"

- Are the volume settings of the A/D Input Part too low?

[EDIT] → [Audio In] → [Mixing] → A/D In "Volume"

- Are the effect settings appropriate?

[EDIT] → [Audio In] → [Routing]

- Is the output setting of the A/D Input Part set appropriately?

[UTILITY] → [Settings] → [Audio I/O] → Output

- Check whether or not the Vocoder Effect is selected.

When Vocoder is selected as the Insertion Effect for the current Part, the audio signal input from the A/D INPUT [L/MONO]/[R] jacks may not produce any sound depending on the parameter settings.

[EDIT] → Part selection → Element/Key/Operator [Common] → [Effect] → [Routing]

Playback continues without stopping.

- When the [ARP ON/OFF] button is turned on, press it so that the button is turned off.
- When in the Song display, press the [■] (Stop) button.
- When the effect sound such as Delay continues, check the effect setting or select the Performance again.
- When the click sound continues, check the following parameter setting. Set this parameter to something other than “always,” since this setting always plays back the click sound regardless of the sequencer status.

[UTILITY] → [Tempo Settings] → Click “Mode”

Distorted sound.

- Are the effect settings appropriate?
Use of an effect at certain settings may produce distortion.

[EDIT] → Part selection → Element/Key/Operator [Common] → [Effect]

- Are the filter settings appropriate?
Excessively high filter resonance settings can cause distortion.

- In case of Normal Part (AWM2) and Drum Part

[EDIT] → Part selection → Element/Key selection → [Filter]

- In case of Normal Part (FM-X)

[EDIT] → Part selection → Element/Key/Operator [Common] → [Pitch/Filter]

- Are any of the following volume parameters set so high that clipping is occurring?

[UTILITY] → [Settings] → [Sound] → Tone Generator “Volume”

[UTILITY] → [Settings] → [Audio I/O] → “Output”

[EDIT] → [General] → “Volume”

[EDIT] → Part selection → Element/Key/Operator [Common] → [Part Settings] → [General] → “Volume”

- In case of Normal Part (AWM2) and Drum Part

[EDIT] → Part selection → Element/Key selection → [Amplitude] → [Level/Pan] → “Level”

- In case of Normal Part (FM-X)

[EDIT] → Part selection → Operator selection → [Level] → “Level”

Sound is cut off.

- Is the entire sound (via your keyboard playback and Song/Part/Arpeggio playback) exceeding the maximum polyphony (128 for AWM2 and 128 for FM-X) of the MODX+?

Only one note sounds at a time.

- When this situation occurs, the Mono/Poly parameter in the current mode is set to “mono.”
If you wish to play chords, set this parameter to “poly.”

[EDIT] → Part selection → Element/Key/Operator [Common] → [Part Settings] → [General] → “Mono/Poly”

Pitch or intervals are wrong.

- Is the Master Tune parameter of each Part set to a value other than “0”?

[UTILITY] → [Settings] → [Sound] → Tone Generator “Tune”

- Is the Note Shift parameter of each Part set to a value other than “0”?

- In case of Normal Part (AWM2) and Drum Part

[EDIT] → Part selection → Element/Key/Operator [Common] → [Part Settings] → [Pitch] → “Note Shift”

[EDIT] → Part selection → Element/Key/Operator [Common] → [Part Settings] → [Pitch] → “Detune”

- In case of Normal Part (FM-X)

[EDIT] → Part selection → Element/Key/Operator [Common] → [Pitch/Filter] → [Pitch] → “Note Shift”

[EDIT] → Part selection → Element/Key/Operator [Common] → [Pitch/Filter] → [Pitch] → “Detune”

■ When the Part produces a wrong pitch, is the appropriate tuning system selected from the Micro Tuning parameter?

- In case of Normal Part (AWM2)

[EDIT] → Part selection → Element/Key/Operator [Common] → [Part Settings] → [Pitch] → “Micro Tuning Name”

- In case of Normal Part (FM-X)

[EDIT] → Part selection → Element/Key/Operator [Common] → [Pitch/Filter] → [Pitch] → “Micro Tuning Name”

■ When the Part produces a wrong pitch, is the LFO Pitch Modulation Depth set too high?

- In case of Normal Part (AWM2)

[EDIT] → Part selection → Element selection → [Element LFO] → “Pitch Mod”

- In case of Normal Part (FM-X)

[EDIT] → Part selection → Element/Key/Operator [Common] → [Mod/Control] → [2nd LFO] → “Pitch Modulation”

■ When a Part produces a wrong pitch, are Coarse tune and Fine tune settings appropriate?

- In case of Normal Part (AWM2) and Drum Part

[EDIT] → Part selection → Element/Key selection → [Osc/Tune] → “Coarse”

[EDIT] → Part selection → Element/Key selection → [Osc/Tune] → “Fine”

- In case of Normal Part (FM-X)

[EDIT] → Part selection → Operator selection → [Form/Freq] → “Coarse”

[EDIT] → Part selection → Operator selection → [Form/Freq] → “Fine”

■ When the Part seems to produce the wrong pitch, is the destination of the controller set to “Pitch”?

[EDIT] → Part selection → [Mod/Control] → [Control Assign] → “Destination”

No effect is applied.

■ Is the Effect Switch turned off?

[UTILITY] → [Effect Switch]

■ Is the Variation Send or Reverb Send set to a value other than “0”?

[EDIT] → Part selection → Element/Key/Operator [Common] → [Effect] → [Routing] → “Var Send”

[EDIT] → Part selection → Element/Key/Operator [Common] → [Effect] → [Routing] → “Rev Send”

■ Is the Variation Return or Reverb Return set to a value other than “0”?

[EDIT] → [Effect] → [Routing] → “Var Return”

[EDIT] → [Effect] → [Routing] → “Rev Return”

■ Have any or all of the Element/Keys' Insertion Effect Output parameters been set to “thru” in the effect setting?

[EDIT] → Part selection → Element/Key/Operator [Common] → [Effect] → [Routing] → “Element 1–8”

■ In case of System Effect, have any or all of the effect types been set to “No Effect”?

■ In case of Insertion Effect, have any or all of the effect types been set to “Thru”?

■ Check whether the Insertion Switch parameters are set properly or not.

[EDIT] → Part selection → Element/Key/Operator [Common] → [Effect] → [Ins A]/[Ins B]

■ Have you exceed the number of Parts for applying Insertion Effect?

For Parts 9 -16, you can apply Insertion Effects to up to 4 Parts.

[EDIT] → Part selection → Element/Key/Operator [Common] → [Effect] → [Ins Assign]

Cannot start the Arpeggio.

■ Check whether the [ARP ON/OFF] button is turned on or off.

■ Count the number of Parts whose Arpeggio switches are turned on.
You can play back the Arpeggios of up to eight Parts simultaneously.

■ Are the Arpeggio related parameters such as Note Limit and Velocity Limit set appropriately?

[EDIT] → Part selection → Element/Key/Operator [Common] → [Arpeggio] → [Common]

- Is the Arpeggio Type parameter set to “off”?

[EDIT] → Part selection → [Arpeggio] → [Individual] → “Name”

- Check the Arpeggio Switch parameter.

If this parameter for the current Part is set to off, Arpeggio playback will not be triggered by your keyboard performance even if the [ARP ON/OFF] button is turned on.

[PERFORMANCE (HOME)] → Part selection → “Arp On”

- Is the [Arp Bypass] button set to “on”?

[UTILITY] → [Effect Switch]

Cannot stop the Arpeggio.

- When Arpeggio playback does not stop even if you release the key, set the Arpeggio Hold parameter to “off.”

[EDIT] → Part selection → Element/Key/Operator [Common] → [Arpeggio] → [Common] → “Hold”

The Song cannot be started even when pressing the [▶] (Play) button.

- Does the selected Song actually contain data?

Song cannot be recorded.

- Is there enough free memory for recording?

MODX+ memory can record up to 128 Songs. If the memory becomes full, no more recording is possible.

Data communication between the computer and the MODX+ does not work properly.

- Check whether the Port settings on the computer are appropriate or not.
- Check whether or not the MIDI IN/OUT parameter is set to the appropriate value.

[UTILITY] → [Settings] → [MIDI I/O] → MIDI “MIDI IN/OUT”

MIDI bulk data transmission/reception does not work properly.

- Is the Receive Bulk parameter set to off?

Set the Receive Bulk parameter to on.

[UTILITY] → [Settings] → [Advanced] → MIDI “Receive Bulk”

- When receiving MIDI bulk data transmitted via the Bulk Dump function and recorded to the external MIDI device, you need to set the MIDI Device Number to the same value as when transmitting.

[UTILITY] → [Settings] → [Advanced] → MIDI “Device Number”

When transmission does not work properly, is the device number of the MIDI instrument connected to the MODX+ set to match the Device Number parameter?

[UTILITY] → [Settings] → [Advanced] → MIDI “Device Number”

Cannot save data to the USB flash drive.

- Is the USB flash drive being used write protected? (Write-protect should be set to off for saving data.)

- Is there enough free space on the USB flash drive?

In the Contents display, set the device to the USB flash drive. Check the amount of currently available (unused) memory of the USB flash drive indicated at the right top of the display.

[UTILITY] → [Contents] → [Load]/[Store/Save]

- Is operation of the particular USB flash drive guaranteed by Yamaha?

For details, see page 61.

In the display, there are some black points (unlit) or white points (always lit).

- These are the result of defective pixels and occasionally occur in LCD; they do not indicate a problem in operation.

Specifications

Keyboards		MODX8+: 88 keys, GHS Keyboard (Initial Touch) MODX7+: 76 keys, Semi-weighted Keyboard (Initial Touch) MODX6+: 61 keys, Semi-weighted Keyboard (Initial Touch)	
Tone Generator block	Tone Generator	Motion Control Synthesis Engine AWM2: 8 Elements FM-X: 8 Operators, 88 Algorithms	
	Polyphony	AWM2: 128 (max.; stereo/mono waveforms) FM-X: 128 (max.)	
	Multi Timbral Capacity	16 Parts (internal), Audio Input Parts (A/D ^{*1} , USB ^{*1}) *1 stereo Part	
	Waveforms	Preset: 5.67 GB (when converted to 16-bit linear format), User: 1.75 GB	
	Performances	2,227	
	Filters	18 types	
	Effect System	Reverb x 12 types, Variation x 88 types, Insertion (A, B) x 88 types ^{*2} , Master Effect x 26 types *2 A/D part insertion x 83 types <Preset settings for parameters of each effect type are provided as templates> Master EQ (5 bands), 1st part EQ (3 bands), 2nd part EQ (2 bands)	
	Sequencer block	Note Capacity	Approx. 130,000 notes (per Pattern or Song)
Storage Size		Approx. 520,000 notes (for Patterns) and approx. 520,000 notes (for Songs)	
Note Resolution		480 ppq (parts per quarter note)	
Tempo (BPM)		5–300	
Patterns		Max. quantity	128 Patterns
		Tracks	16 Sequence tracks
		Recording type	Real time replace, Real time overdub
Songs		Max. quantity	128 Songs
		Tracks	16 Sequence tracks, Tempo track, Scene track
		Recording type	Real time replace, Real time overdub, Real time punch in/out
Sequence Format		MODX original format, SMF formats 0, 1	
Arpeggio		Part	8 Parts simultaneous (max.)
		Preset	10,239 types
		User	256 types
Motion Sequencer	Lane	8 + 1 Lanes (max.)	
Others	Live Sets	Preset: 256 and more, User: 2,048	
	Controllers	Master Volume, AD Input Gain knob, USB Volume, Pitch Bend wheel, Modulation wheel, Control Sliders x 4, Knobs x 4, Super Knob, Data dial	
	Display	7" TFT Color Wide VGA LCD touch screen	
	Connectors	[USB TO DEVICE], [USB TO HOST], MIDI [IN]/[OUT], FOOT CONTROLLER [1]/[2], FOOT SWITCH [ASSIGNABLE]/[SUSTAIN], OUTPUT [L/MONO]/[R] (6.3 mm, standard phone jacks), [PHONES] (6.3 mm, standard stereo phone jack), A/D INPUT [L/MONO]/[R] (6.3 mm, standard phone jacks)	
	USB Audio Interface	Sampling Frequency	44.1 kHz
		Channels	In: 4 channels (2 stereo channels) Out: 10 channels (5 stereo channels)
	AC Adaptor	PA-150 or an equivalent recommended by Yamaha (Output: DC 12 V, 1.5 A)	
	Power Consumption	16 W (when using PA-150B AC adaptor)	
	Standby Power Consumption	0.3 W	
	Dimensions, Weight	MODX8+: 1,333 (W) × 404 (D) × 160 (H) mm (52-1/2" × 15-7/8" × 6-1/16"), 13.8 kg (30 lbs 7 oz) MODX7+: 1,144 (W) × 331 (D) × 134 (H) mm (45-1/16" × 13-1/16" × 5-1/4"), 7.4 kg (16 lbs 5 oz) MODX6+: 937 (W) × 331 (D) × 134 (H) mm (36-7/8" × 13-1/16" × 5-1/4"), 6.6 kg (14 lbs 9 oz)	

Others	Accessories	AC adaptor (PA-150B or an equivalent recommended by Yamaha*), Owner's Manual (this book), Cubase AI Download Information * May not be included depending on your area. Check with your Yamaha dealer.
--------	-------------	---

* The contents of this manual apply to the latest specifications as of the publishing date. To obtain the latest manual, access the Yamaha website then download the manual file. Since specifications, equipment or separately sold accessories may not be the same in every locale, please check with your Yamaha dealer.

GNU GENERAL PUBLIC LICENSE

GNU LESSER GENERAL PUBLIC LICENSE

Note on source code distribution

For three years after the final factory shipment, you may request from Yamaha the source code for any portions of the product which are licensed under the GNU General Public License or GNU Lesser General Public License by writing to the following address:

DMI Strategy Planning Group, DMI Division
Digital Musical Instruments Division
YAMAHA Corporation
10-1 Nakazawa-cho, Chuo-ku, Hamamatsu, 430-8650, JAPAN

The source code will be provided at no charge; however, we may require you to reimburse Yamaha for the cost of delivering the source code to you.

- Note that we shall bear no responsibility whatsoever for any damage arising from changes (additions/ deletions) made to the software for this product by a third party other than Yamaha (or party authorized by Yamaha).
- Note that re-use of source code released to the public domain by Yamaha is unguaranteed, and Yamaha shall not bear any responsibility whatsoever for the source code.
- The source code can be downloaded from the following address:
<https://download.yamaha.com/sourcecodes/synth/>

Index

A

A/D INPUT [GAIN] knob	10
A/D INPUT [L/MONO]/[R] jacks	17
A/D INPUT [ON/OFF] button	10
ABS (Audio Beat Sync)	17
[ARP ON/OFF] (Arpeggio on/off) button	11
Arpeggio	28
Arpeggio type	43
[ASSIGN 1] and [ASSIGN 2] buttons (Assignable switches 1 and 2)	11
[ASSIGN] button	12
Audio channel	56
[AUDITION] button	15
Audition phrase	25
Auto Power Off	19

C

Carrier	38
[CATEGORY] button	15
Category Search	24
Compare function	40
[CONTROL ASSIGN] button	13
Control Sliders 1–4 (5–8/9–12/13–16)	12
Controllers	29
Cursor buttons	14, 20

D

Data dial	14
DAW (digital audio workstation)	55
[DC IN]	17
[DEC/NO] button	14
Display Messages	63
Drum Part	22

E

[EDIT] button	14
Effect	39
Element Common Edit	38
Element Edit	38
[ENTER] button	14
Envelope Follower	17, 44
[EXIT] button	14

F

Flag	23
FM	38
FOOT CONTROLLER [1]/[2] jacks	17
FOOT SWITCH [ASSIGNABLE]/[SUSTAIN] jacks	17
Formatting	61
Frequency modulation	38

G

GM	22
GM Bank	22

H

Headphones	18
------------------	----

I

[INC/YES] button	14
Initial factory settings	19
Initialized Performance	25
Inputting on the keyboard	21
Inputting on the numeric keypad	21

K

Key Common Edit	38
Key Edit	38
Keyboard	10
Knob Function [TONE]/[EG/FX]/[EQ]/[ARP/MS] button	12
KNOB POSITION [1] and [2] buttons	13
Knobs	30
Knobs 1–4 (5–8)	12

L

Layer	41
Library Bank	22
Live Set	23, 35
[LIVE SET] button	15
Live Set display	20
Loading	60
Local Control	53

M

Master Tuning	52
MASTER VOLUME	10
[MASTER VOLUME] knob	10
Microphone	50
MIDI [IN], [OUT] terminals	17
MIDI port	56
MIDI Recording	45
Mixing	33
Modulation wheel	10
Modulator	38
[MOTION SEQ HOLD] (Motion Sequencer hold) button	11
[MOTION SEQ TRIGGER] (Motion Sequencer trigger) button	11
Motion Sequencer	28
[MS ON/OFF] (Motion Sequencer on/off) button	11
Multi Part Performance	22
Mute function	27

N

Normal Part (AWM2)	22
Normal Part (FM-X)	22

O

OCTAVE [-] and [+] buttons	11
Operator	38
Operator Common Edit	38
Operator Edit	38
OUTPUT [L/MONO] and [R] jacks	17

P

Panel Lock	62
Part Control status	30
Part Editing	38
[PART SELECT MUTE/SOLO] button	15
Performance	22
[PERFORMANCE (HOME)] button	14
Performance Control status	30
Performance Edit display	37
Performance Editing	37
Performance Play	26
Performance Play display	20
[PHONES] (Headphone) jack	17
Pitch Bend wheel	10
Power	18
Power-on tasks	51
Preset Bank	22
Punch In/Out	46

Q

Quick Setup	55
-------------------	----

R

Realtime Recording	45
Redo	47
Rhythm Part	43
Rhythm Pattern	43
[RHYTHM PATTERN] button	13

S

Saving	60
SCENE [1/5] [2/6] [3/7] [4/8] buttons	12
Scene function	34
Scene Select [1–4] [5–8] button	12
SEQ TRANSPORT button	13
[SHIFT] button	14
Single Part Performance	22
Slider Function [PART]/[ELEMENT/OPERATOR] button	12
Slider Select [1–4] [5–8] button	12
Solo function	27
Song	45, 47
Split	42
SSS (Seamless Sound Switching)	23
[⏻] (Standby/On) switch	17
Store	37
[STORE] button	14
Super Knob	13, 31

T

Touch panel LCD	13
Track	45

U

Undo	47
[USB TO DEVICE] terminal	17, 61
[USB TO HOST] terminal	17, 56
[USB VOLUME (MONITOR)] knob	10
User Bank	22
[UTILITY] button	14

Y

Yamaha Steinberg USB Driver	55
-----------------------------------	----

Z

Zone	49
------------	----

MEMO

Important Notice: Power management information for customers in European Economic Area (EEA), Switzerland and Turkey

Remarque importante : Informations sur la gestion de l'alimentation pour les clients de l'Espace économique européen (EEE), de Suisse et de Turquie

Yamaha products are equipped with a power management function. Some products allow you to disable that function, or to extend the amount of time that elapses before the power is turned off or set to standby. In these cases, energy consumption will increase.	English
Yamaha-Produkte sind mit einer Power-Management-Funktion ausgestattet. Bei einigen Produkten können Sie diese Funktion ausschalten oder die Zeitdauer, die verstreicht, bis das Instrument ausgeschaltet oder in Bereitschaft versetzt wird, verlängern. In diesen Fällen erhöht sich der Energieverbrauch.	Deutsch
Les produits Yamaha sont équipés d'une fonction de gestion de l'alimentation. Certains produits vous permettent de désactiver cette fonction ou d'allonger le délai avant la mise hors tension ou la mise en veille. Dans ces cas, la consommation d'énergie augmente.	Français
Yamaha-producten zijn uitgerust met een energiebeheerfunctie. Bij sommige producten kunt u die functie uitschakelen of de tijd verlengen die verstrijkt voordat de stroom wordt uitgeschakeld of in stand-by wordt gezet. In deze gevallen zal het energieverbruik toenemen.	Nederlands
Los productos Yamaha están equipados con una función de administración de energía. Algunos productos permiten desactivar esa función o ampliar el tiempo que transcurre antes de apagar la alimentación o poner el producto en modo de espera. En estos casos, el consumo de energía aumentará.	Español
I prodotti Yamaha sono dotati di una funzione di gestione dell'alimentazione. Alcuni prodotti consentono di disattivare tale funzione o di estendere il periodo di tempo che trascorre prima che l'alimentazione venga spenta o impostata in standby. In questi casi, il consumo energetico aumenterà.	Italiano
Os produtos Yamaha são equipados com uma função de gerenciamento de energia. Alguns produtos permitem desativar essa função ou estender o tempo decorrido antes de se desligar ou entrar em standby. Nesses casos, o consumo de energia aumentará.	Português
Τα προϊόντα της Yamaha είναι εξοπλισμένα με μια λειτουργία διαχείρισης ισχύος. Ορισμένα προϊόντα σας δίνουν τη δυνατότητα να απενεργοποιείτε αυτή τη λειτουργία ή να επεκτείνετε το χρονικό διάστημα μέχρι την απενεργοποίηση ή τη θέση σε κατάσταση αναμονής. Σε αυτές τις περιπτώσεις, η κατανάλωση ενέργειας θα αυξηθεί.	Ελληνικά
Yamaha-produkterna är utrustade med en energihanteringsfunktion. För vissa produkter kan du inaktivera den funktionen eller för att förlänga tiden som förflutit innan strömmen stängs av eller ställs i vänteläge. I dessa fall ökar energiförbrukningen.	Svenska
Yamahas produkter har en strømstyringsfunktion. På nogle produkter er det muligt at deaktivere denne funktion eller at forlænge den tid, der går, før der slukkes for strømmen, eller sættes på standby. I disse tilfælde vil strømforbruget stige.	Dansk
Yamaha-tuotteet on varustettu virranhallintatoiminnolla. Joissakin tuotteissa voit poistaa toiminnon käytöstä tai pidentää aikaa, joka kuluu ennen virran katkaisemista tai valmiustilaan asettamista. Näissä tapauksissa energiankulutus kasvaa.	Suomi
Produkty Yamaha są wyposażone w funkcję zarządzania energią. Niektóre produkty umożliwiają wyłączenie tej funkcji lub wydłużenie czasu, jaki upływa do wyłączenia zasilania lub przejścia w tryb gotowości. W takich przypadkach zużycie energii wzrośnie.	Polski
Produkty Yamaha jsou vybaveny funkcí správy napájení. Některé produkty umožňují tuto funkci zakázat nebo prodloužit dobu, která má uběhnout před vypnutím napájení nebo pohotovostním režimem. V těchto případech se zvýší spotřeba elektřiny.	Čeština
A Yamaha termékek energiamedzszment funkcióval vannak ellátva. Egyes termékek lehetővé teszik, hogy letiltsa ezt a funkciót, vagy meghosszabbítsa a kikapcsolás vagy készenléti állapotba helyezés előtt eltelt időt. Ezekben az esetekben az energiafogyasztás növekedni fog.	Magyar
Yamaha tooted on varustatud toitehalduse funktsiooniga. Mõned tooted võimaldavad teil selle funktsiooni keelata või pikendada aega, mis möödub enne toite väljalülitamist või ooterežiimi seadmist. Sellistel juhtudel suureneb energiatarbimine.	Eesti
Yamaha izstrādājumi ir aprīkoti ar barošanas pārvaldības funkciju. Dažiem izstrādājumiem šo funkciju var atspējot vai paildzināt laiku, kam jāpauz pirms barošanas atslēgšanas vai pāriešanas gaidstāves režīmā. Šādā gadījumā palielināsies enerģijas patēriņš.	Latviešu
„Yamaha“ gaminiuose yra energijos sąnaudų valdymo funkcija. Kai kurie gaminiai leidžia išjungti šią funkciją arba pratęsti laiką, praėjusį prieš išjungiant maitinimą arba įjungiant budėjimo režimą. Tokiais atvejais energijos suvartojimas padidės.	Lietuvių
Produkty společnosti Yamaha sú vybavené funkciou správy napájania. Niektoré produkty vám umožňujú túto funkciu vypnúť alebo predĺžiť čas, po uplynutí ktorých sa napájanie vypne alebo nastaví do pohotovostného režimu. V takýchto prípadoch sa zvýši spotreba energie.	Slovenčina
Yamahini izdelki imajo funkcijo upravljanja z napajanjem. Nekateri izdelki vam omogočajo, da onemogočite to funkcijo ali podaljšate čas, ki mora preteči, preden se napajanje izklopi ali nastavi v stanje pripravljenosti. V teh primerih se bo poraba energije povečala.	Slovenščina
Продуктите на Yamaha са снабдени с функция за управление на захранването. Някои продукти ви позволяват да забраните тази функция или да удължите времето, което ще изтече, преди захранването да се изключи или да се настрои в режим на готовност. В тези случаи консумацията на енергия ще се увеличи.	Български
Produsele Yamaha sunt echipate cu o funcție de gestionare a energiei. Unele produse vă permit să dezactivați această funcție sau să prelungiți perioada de timp care trece înainte ca alimentarea să fie oprită sau setată în standby. În aceste cazuri, consumul de energie va crește.	Română
Yamaha proizvodi opremljeni su funkcijom upravljanja potrošnjom energije. Neki vam proizvodi omogućuju onemogućavanje te funkcije ili produženje vremena koje protekne prije isključivanja napajanja ili postavljanja u stanje pripravnosti. U tim će se slučajevima povećati potrošnja energije.	Hrvatski
Yamaha ürünlerinde güç yönetimi işlevi vardır. Bazı ürünler, bu işlevi devre dışı bırakmanıza veya güç kapatılmadan ya da bekleme moduna alınmadan önce geçen süreyi uzatmanıza olanak tanır. Bu gibi durumlarda, enerji tüketimi artacaktır.	Türkçe



**Important Notice:
U.S. LIMITED WARRANTY for Customers in the United States**

For detailed information about this Yamaha product and warranty service, please either visit the following website address (printable file is available at our website) or contact Customer Service at the address or telephone number identified below.

Website Address:

Yamaha.io/SynthAndStageWarranty

Customer Service:

Yamaha Corporation of America
6600 Orangethorpe Avenue, Buena Park, CA 90620-1273
Telephone: 800-854-1569

Important Notice: Guarantee Information for customers in European Economic Area (EEA) and Switzerland

Important Notice: Guarantee Information for customers in EEA* and Switzerland For detailed guarantee information about this Yamaha product, and Pan-EEA* and Switzerland warranty service, please either visit the website address below (Printable file is available at our website) or contact the Yamaha representative office for your country. * EEA: European Economic Area	English
Wichtiger Hinweis: Garantie-Information für Kunden in der EWR* und der Schweiz Für nähere Garantie-Information über dieses Produkt von Yamaha, sowie über den Pan-EWR*- und Schweizer Garantieservice, besuchen Sie bitte entweder die folgend angegebene Internetadresse (eine druckfähige Version befindet sich auch auf unserer Webseite), oder wenden Sie sich an den für Ihr Land zuständigen Yamaha-Vertrieb. *EWR: Europäischer Wirtschaftsraum	Deutsch
Remarque importante: informations de garantie pour les clients de l'EEE et la Suisse Pour des informations plus détaillées sur la garantie de ce produit Yamaha et sur le service de garantie applicable dans l'ensemble de l'EEE ainsi qu'en Suisse, consultez notre site Web à l'adresse ci-dessous (le fichier imprimable est disponible sur notre site Web) ou contactez directement Yamaha dans votre pays de résidence. * EEE : Espace Economique Européen	Français
Belangrijke mededeling: Garantie-informatie voor klanten in de EER* en Zwitserland Voor gedetailleerde garantie-informatie over dit Yamaha-product en de garantieservice in heel de EER* en Zwitserland, gaat u naar de onderstaande website (u vindt een afdrukbaar bestand op onze website) of neemt u contact op met de vertegenwoordiging van Yamaha in uw land. * EER: Europese Economische Ruimte	Nederlands
Aviso importante: información sobre la garantía para los clientes del EEE* y Suiza Para una información detallada sobre este producto Yamaha y sobre el soporte de garantía en la zona EEE* y Suiza, visite la dirección web que se incluye más abajo (la versión del archivo para imprimir esta disponible en nuestro sitio web) o póngase en contacto con el representante de Yamaha en su país. * EEE: Espacio Económico Europeo	Español
Avviso importante: informazioni sulla garanzia per i clienti residenti nell'EEA* e in Svizzera Per informazioni dettagliate sulla garanzia relativa a questo prodotto Yamaha e l'assistenza in garanzia nei paesi EEA* e in Svizzera, potete consultare il sito Web all'indirizzo riportato di seguito (è disponibile il file in formato stampabile) oppure contattare l'ufficio di rappresentanza locale della Yamaha. * EEA: Area Economica Europea	Italiano
Aviso importante: informações sobre as garantias para clientes da AEE* e da Suíça Para obter uma informação pormenorizada sobre este produto da Yamaha e sobre o serviço de garantia na AEE* e na Suíça, visite o site a seguir (o arquivo para impressão está disponível no nosso site) ou entre em contato com o escritório de representação da Yamaha no seu país. * AEE: Área Económica Europeia	Português
Σημαντική σημείωση: Πληροφορίες εγγύησης για τους πελάτες στον ΕΟΧ* και Ελλάδα Για λεπτομερείς πληροφορίες εγγύησης σχετικά με το παρόν προϊόν της Yamaha και την κάλυψη εγγύησης σε όλες τις χώρες του ΕΟΧ και την Ελλάδα, επισκεφτείτε την παρακάτω ιστοσελίδα (Εκτυπώσιμη μορφή είναι διαθέσιμη στην ιστοσελίδα μας) ή απευθυνθείτε στην αντιπροσωπεία της Yamaha στη χώρα σας. * ΕΟΧ: Ευρωπαϊκός Οικονομικός Χώρος	Ελληνικά
Viktigt: Garantiinformation för kunder i EES-området* och Schweiz För detaljerad information om denna Yamahaprodukt samt garantiservice i hela EES-området* och Schweiz kan du antingen besöka nedanstående webbadress (en utskriftsvänlig fil finns på webbplatsen) eller kontakta Yamahas officiella representant i ditt land. * EES: Europeiska Ekonomiska Samarbetsområdet	Svenska
Viktig merknad: Garantiinformasjon for kunder i EØS* og Sveits Detaljert garantiinformasjon om dette Yamaha-produktet og garantiservice for hele EØS-området* og Sveits kan fås enten ved å besøke nettstedene nedenfor (utskriftsversjon finnes på våre nettsider) eller kontakte Yamahas kontoret i landet der du bor. *EØS: Det europeiske økonomiske samarbeidsområdet	Norsk
Vigtig oplysning: Garantioplysninger til kunder i EØO* og Schweiz De kan finde detaljerede garantioplysninger om dette Yamaha-produkt og den fælles garantiserviceordning for EØO* (og Schweiz) ved at besøge det websted, der er angivet nedenfor (der findes en fil, som kan udskrives, på vores websted), eller ved at kontakte Yamahas nationale repræsentationskontor i det land, hvor De bor. * EØO: Det Europæiske Økonomiske Område	Dansk
Tärkeä ilmoitus: Takuutiedot Euroopan talousalueen (ETA)* ja Sveitsin asiakkaille Tämän Yamaha-tuotteen sekä ETA-alueen ja Sveitsin takuuta koskevat yksityiskohtaiset tiedot saatte alla olevasta nettiosoitteesta. (Tulostettava tiedosto saatavissa sivustollamme.) Voitte myös ottaa yhteyttä paikalliseen Yamaha-edustajaan. *ETA: Euroopan talousalue	Suomi
Ważne: Warunki gwarancyjne obowiązujące w EOG* i Szwajcarii Aby dowiedzieć się więcej na temat warunków gwarancyjnych tego produktu firmy Yamaha i serwisu gwarancyjnego w całym EOG* i Szwajcarii, należy odwiedzić wskazaną poniżej stronę internetową (Plik gotowy do wydruku znajduje się na naszej stronie internetowej) lub skontaktować się z przedstawicielem firmy Yamaha w swoim kraju. * EOG — Europejski Obszar Gospodarczy	Polski
Důležité oznámení: Záruční informace pro zákazníky v EHS* a ve Švýcarsku Podrobné záruční informace o tomto produktu Yamaha a záručním servisu v celém EHS* a ve Švýcarsku naleznete na níže uvedené webové adrese (soubor k tisku je dostupný na našich webových stránkách) nebo se můžete obrátit na zastoupení firmy Yamaha ve své zemi. * EHS: Evropský hospodářský prostor	Česky
Fontos figyelemzetetés: Garancia-információk az EGT* területén és Svájcban élő vásárlók számára A jelen Yamaha termékre vonatkozó részletes garancia-információk, valamint az EGT*-re és Svájcra kiterjedő garanciális szolgáltatás tekintetében keresse fel webhelyünket az alábbi címen (a webhelyen nyomtatható fájl is talál), vagy pedig lépjen kapcsolatba az országában működő Yamaha képviselői irodával. * EGT: Európai Gazdasági Térség	Magyar
Oluline märkus: Garantiiteave Euroopa Majanduspiirkonna (EMP)* ja Šveitsi klientidele Täpsema teabe saamiseks selle Yamaha toote garantii ning kogu Euroopa Majanduspiirkonna ja Šveitsi garantiiteeninduse kohta, külastage palun veebisaiti alljärgneval aadressil (meie saidil on saadaval prinditav fail) või pöörduge Teie regiooni Yamaha esinduse poole. * EMP: Euroopa Majanduspiirkond	Eesti keel
Svarīgs paziņojums: garantijas informācija klientiem EEZ* un Šveicē Lai saņemtu detalizētu garantijas informāciju par šo Yamaha produktu, kā arī garantijas apkalpošanu EEZ* un Šveicē, lūdzu, apmeklējiet zemāk norādīto tīmekļa vietnes adresi (tīmekļa vietnē ir pieejams drukājams fails) vai sazinieties ar jūsu valsti apkalpojošo Yamaha pārstāvniecību. * EEZ: Eiropas Ekonomikas zona	Latviešu
Dėmesio: informacija dėl garantijos pirkėjams EEE* ir Šveicarijoje Jei reikia išsamios informacijos apie šį „Yamaha“ produktą ir jo techninę priežiūrą visoje EEE* ir Šveicarijoje, apsilankykite mūsų svetainėje toliau nurodytu adresu (svetainėje yra spausdintinas failas) arba kreipkitės į „Yamaha“ atstovybę savo šaliai. *EEE – Europos ekonominė erdvė	Lietuvių kalba
Dôležité upozornenie: Informácie o záruke pre zákazníkov v EHP* a Švajčiarsku Podrobné informácie o záruke týkajúce sa tohto produktu od spoločnosti Yamaha a garančnom servise v EHP* a Švajčiarsku nájdete na webovej stránke uvedenej nižšie (na našej webovej stránke je k dispozícii súbor na tlač) alebo sa obráťte na zástupcu spoločnosti Yamaha vo svojej krajine. * EHP: Európsky hospodársky priestor	Slovenčina
Pomembno obvestilo: Informacije o garanciji za kupce v EGP* in Švici Za podrobnejše informacije o tem Yamahinem izdelku ter garancijskem servisu v celotnem EGP in Švici, obiščite spletno mesto, ki je navedeno spodaj (natisljiva datoteka je na voljo na našem spletnem mestu), ali se obrnite na Yamahinega predstavnika v svoji državi. * EGP: Evropski gospodarski prostor	Slovenščina
Важно съобщение: Информация за гаранцията за клиенти в ЕИП* и Швейцария За подробна информация за гаранцията за този продукт на Yamaha и гаранционното обслужване в паневропейската зона на ЕИП* и Швейцария или посетете посочения по-долу уеб сайт (на нашия уеб сайт има файл за печат), или се свържете с представителния офис на Yamaha във вашата страна. * ЕИП: Европейско икономическо пространство	Български език
Notificare importantă: Informații despre garanție pentru clienții din SEE* și Elveția Pentru informații detaliate privind acest produs Yamaha și serviciul de garanție Pan-SEE* și Elveția, vizitați site-ul la adresa de mai jos (fișierul imprimabil este disponibil pe site-ul nostru) sau contactați biroul reprezentanței Yamaha din țara dumneavoastră. * SEE: Spațiul Economic European	Limba română
Važna obavijest: Informacije o jamstvu za države EGP-a i Švicarske Za detaljne informacije o jamstvu za ovaj Yamahin proizvod te jamstvenom servisu za cijeli EGP i Švicarsku, molimo Vas da posjetite web-stranicu navedenu u nastavku ili kontaktirate ovlaštenog Yamahinog dobavljača u svojoj zemlji. * EGP: Evropski gospodarski prostor	Hrvatski

<https://europe.yamaha.com/warranty/>

Yamaha Worldwide Representative Offices

English

For details on the product(s), contact your nearest Yamaha representative or the authorized distributor, found by accessing the 2D barcode below.

Deutsch

Wenden Sie sich für nähere Informationen zu Produkten an eine Yamaha-Vertretung oder einen autorisierten Händler in Ihrer Nähe. Diese finden Sie mithilfe des unten abgebildeten 2D-Strichodes.

Français

Pour obtenir des informations sur le ou les produits, contactez votre représentant ou revendeur agréé Yamaha le plus proche. Vous le trouverez à l'aide du code-barres 2D ci-dessous.

Español

Para ver información detallada sobre el producto, contacte con su representante o distribuidor autorizado Yamaha más cercano. Lo encontrará escaneando el siguiente código de barras 2D.

Português

Para mais informações sobre o(s) produto(s), fale com seu representante da Yamaha mais próximo ou com o distribuidor autorizado acessando o código de barras 2D abaixo.

Italiano

Per dettagli sui prodotti, contattare il rappresentante Yamaha o il distributore autorizzato più vicino, che è possibile trovare tramite il codice a barre 2D in basso.

Nederlands

Neem voor meer informatie over de producten contact op met uw dichtstbijzijnde Yamaha-vertegenwoordiger of de geautoriseerde distributeur, te vinden via de onderstaande 2D-barcode.

Polski

Aby uzyskać szczegółowe informacje na temat produktów, skontaktuj się z najbliższym przedstawicielem firmy Yamaha lub autoryzowanym dystrybutorem, którego znajdziesz za pośrednictwem poniższego kodu kreskowego 2D.

Русский

Чтобы узнать подробнее о продукте (продуктах), свяжитесь с ближайшим представителем или авторизованным дистрибьютором Yamaha, воспользовавшись двухмерным штрихкодом ниже.

Dansk

Hvis du vil have detaljer om produktet/produkterne, kan du kontakte den nærmeste Yamaha-repræsentant eller autoriserede Yamaha-distributør, som du finder ved at scanne 2D-stregkode nedenfor.

Svenska

Om du vill ha mer information om produkterna kan du kontakta närmaste Yamaha-representant eller auktoriserade distributör med hjälp av 2D-streckkoden nedan.



https://manual.yamaha.com/dmi/address_list/

Čeština

Podrobnosti o produktu(ech) získáte od nejbližšího zástupce společnosti Yamaha nebo autorizovaného distributora, který byl nalezen při použití 2D čárového kódu níže.

Slovenčina

Podrobné informácie o produkte(-och) vám poskytne najbližší zástupca spoločnosti Yamaha alebo autorizovaný distribútor, ktorého nájdete pomocou nižšie uvedeného 2D čiarového kódu.

Magyar

A termék(ek)re vonatkozó részletekért forduljon a legközelebbi Yamaha képviselőhöz vagy a hivatalos forgalmazóhoz, amelyet az alábbi 2D vonalkód segítségével találhat meg.

Slovenščina

Če želite podrobnejše informacije o izdelkih, se obrnite na najbližjega Yamahinega predstavnika ali pooblaščenega distributerja, ki ga najdete prek 2D-kode v nadaljevanju.

Български

За подробности относно продукта/ите се свържете с най-близкия представител на Yamaha или оторизиран дистрибутор, който можете да откриете, като използвате 2D баркода по-долу.

Română

Pentru detalii privind produsele, contactați cel mai apropiat reprezentant Yamaha sau distribuitorul autorizat, pe care îl puteți găsi accesând codul de bare 2D de mai jos.

Latviešu

Lai iegūtu plašāku informāciju par izstrādājumiem, sazinieties ar tuvāko Yamaha pārstāvi vai pilnvaroto izplatītāju, kuru atradīsiet, izmantojot tālāk pieejamo 2D svītrkodu.

Lietuvių

Norėdami gauti daugiau informacijos apie gaminį (-ius), kreipkitės į artimiausią „Yamaha“ atstovą arba įgaliotąjį platintoją, kurį rasite nuskaityę toliau pateiktą 2D brūkšninį kodą.

Eesti

Toodete kohta täpsema teabe saamiseks võtke ühendust lähima Yamaha esindaja või autoriseeritud levitajaga, kelle leiate allpool asuva 2D-võõtkoodi kaudu.

Hrvatski

Za detalje o proizvodima obratite se lokalnom predstavku ili ovlaštenom distributeru tvrtke Yamaha, kojeg možete pronaći skeniranjem 2D crtičnog koda u nastavku.

Türkçe

Ürünler hakkında ayrıntılar için, aşağıdaki 2D kodlu motora erişerek bulunan size en yakın Yamaha temsilcisine veya yetkili bayiye başvurun.

