

YAMAHA GE-60

*Natural Sound Stereo Graphic Equalizer
10 Bands of ± 15 dB EQ per Channel
Independent Left/Right Output Level Controls
Continuously Variable Subsonic Filter Frequencies
10-Band Frequency Spectrum Analyzer
Built-in Pink Noise Generator
Electret Condenser Microphone Supplied*

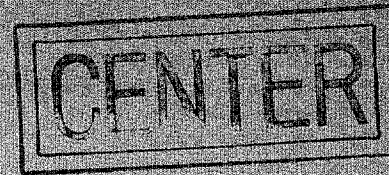

OWNER'S MANUAL



Thank you for purchasing the YAMAHA GE-60 stereo graphic equalizer.

CONTENTS

SAFETY INSTRUCTIONS	1
CAUTION	2
CONNECTION DIAGRAM	3/4
FRONT PANEL PARTS AND FUNCTIONS	5/6/7
OPERATING METHOD	8/9/10/11
TROUBLESHOOTING	12
BLOCK DIAGRAM	13
SPECIFICATIONS	14

IMPORTANT

Please record the serial number of your unit in the space below.

Model: **GE-60**

Serial No. _____

The serial number is located on the rear of the unit.

Retain this Owner's Manual in a safe place for future reference.

WARNING

To prevent fire or shock hazard, do not expose this appliance to rain or moisture.

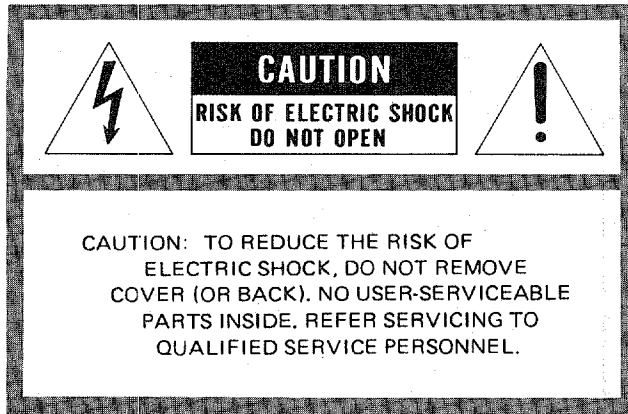

• Explanation of Graphical Symbols

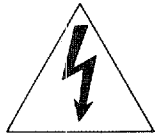

The lightning flash with arrowhead symbol, within an equilateral triangle, is intended to alert you to the presence of uninsulated "dangerous voltage" within the product's enclosure that may be of sufficient magnitude to constitute a risk of electric shock to persons.

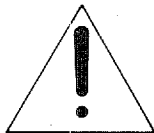

The exclamation point within an equilateral triangle is intended to alert you to the presence of important operating and maintenance (servicing) instructions in the literature accompanying the appliance.

SAFETY INSTRUCTIONS

- 1** Read Instructions — All the safety and operating instructions should be read before the appliance is operated.
- 2** Retain Instructions — The safety and operating instructions should be retained for future reference.
- 3** Heed Warnings — All warnings on the appliance and in the operating instructions should be adhered to.
- 4** Follow Instructions — All operating and other instructions should be followed.
- 5** Water and Moisture — The appliance should not be used near water — for example, near a bathtub, washbowl, kitchen sink, laundry tub, in a wet basement, or near a swimming pool, etc.
- 6** Carts and Stands — The appliance should be used only with a cart or stand that is recommended by the manufacturer.
- 7** Wall or Ceiling Mounting — The appliance should be mounted to a wall or ceiling only as recommended by the manufacturer.
- 8** Ventilation — The appliance should be situated so that its location or position does not interfere with its proper ventilation. For example, the appliance should not be situated on a bed, sofa, rug, or similar surface that may block the ventilation openings; or placed in a built-in installation, such as a bookcase or cabinet that may impede the flow of air through the ventilation openings.
- 9** Heat — The appliance should be situated away from heat sources such as radiators, stoves, or other appliances that produce heat.
- 10** Power Sources — The appliance should be connected to a power supply only of the type described in the operating instructions or as marked on the appliance.
- 11** Power-Cord Protection — Power-supply cords should be routed so that they are not likely to be walked on or pinched by items placed upon or against them, paying particular attention to cords at plugs, convenience receptacles, and the point where they exit from the appliance.
- 12** Cleaning — The appliance should be cleaned only as recommended by the manufacturer.
- 13** Nonuse Periods — The power cord of the appliance should be unplugged from the outlet when left unused for a long period of time.
- 14** Object and Liquid Entry — Care should be taken so that objects do not fall into and liquids not spilled into the inside of the appliance.
- 15** Damage Requiring Service — The appliance should be serviced by qualified service personnel when:
 - A. The power-supply cord or the plug has been damaged; or
 - B. Objects have fallen, or liquid has been spilled into the appliance; or
 - C. The appliance has been exposed to rain; or
 - D. The appliance does not appear to operate normally or exhibits a marked change in performance; or
 - E. The appliance has been dropped, or the cabinet damaged.
- 16** Servicing — The user should not attempt to service the appliance beyond those means described in the operating instructions. All other servicing should be referred to qualified service personnel.

**CAUTION: READ THIS BEFORE
OPERATING YOUR GE-60**

1

The GE-60 is a sophisticated stereo graphic equalizer. To ensure proper operation for the best possible sound reproduction, please read this manual carefully.

2

Choose the installation location of your GE-60 carefully. Avoid placing it in direct sunlight or close to a source of heat. Also avoid locations subject to vibration and excessive dust, heat, cold or moisture. Keep away from such sources of hum as transformers or motors.

3

Do not open the cabinet as this might result in damage to the set or electrical shock. If a foreign object should get into the set, contact your dealer.

4

When removing the power plug from the wall outlet, always pull directly on the plug; never yank the cord.

5

Do not use force when using the switches and knobs.

6

When moving the unit be sure to first pull out the power plug and remove cords connecting to other equipment.

7

Do not attempt to clean the GE-60 with chemical solvents as this might damage the finish. Use a clean, dry cloth.

8

Be sure to read the "troubleshooting" section for advice on common operating errors before concluding that your GE-60 is faulty.

9

Keep this manual in a safe place for future reference.

10

Do not connect audio equipment to the AC outlets on the rear panel if that equipment requires more power than the outlets are rated to provide.

GE-60

CONNECTION DIAGRAM

- When connecting your equipment, turn the power to each unit off and make sure that you have correctly connected the Left (L) and Right (R) channels.

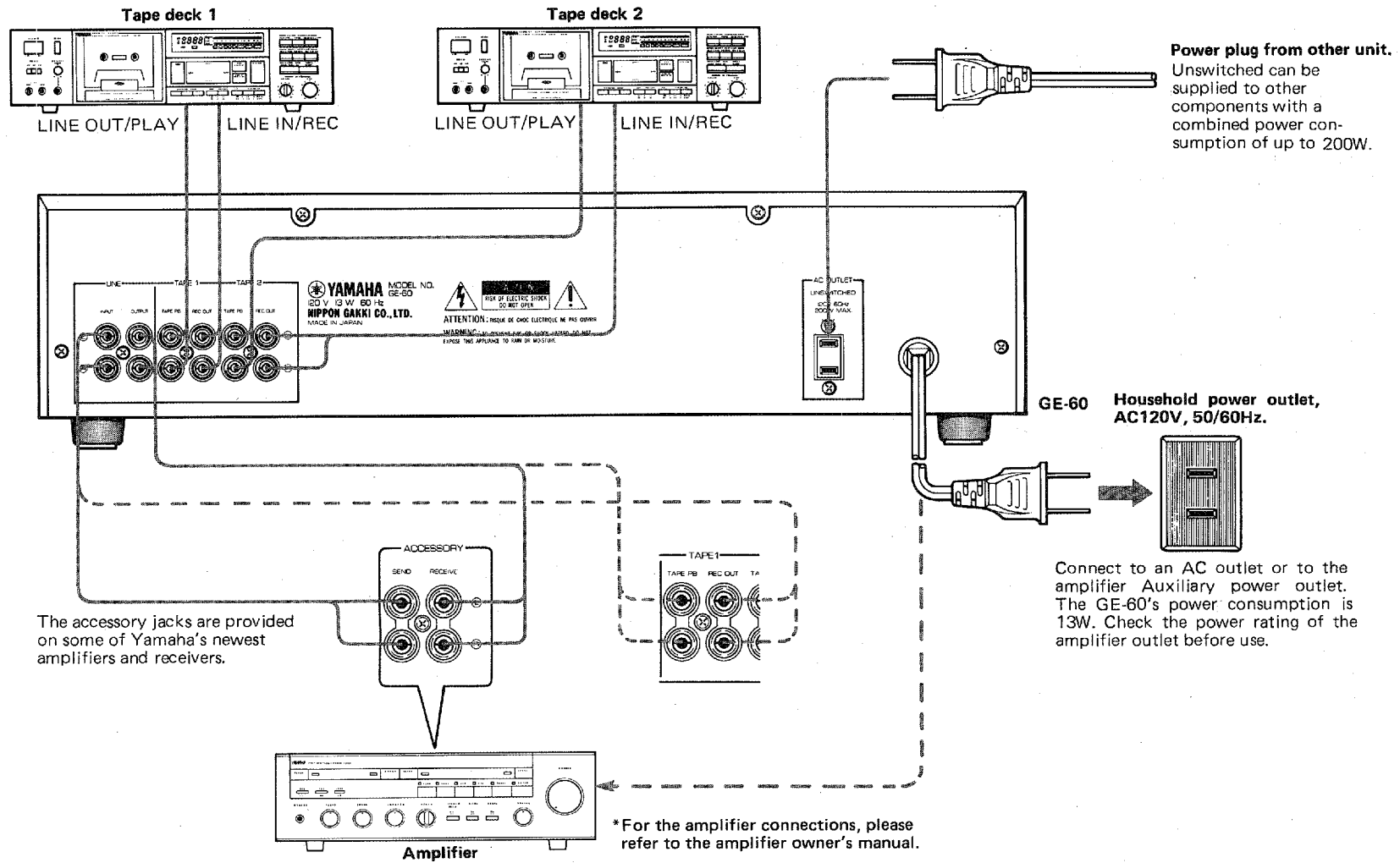

GE-60

■ CONNECTING AN AMPLIFIER

Check from the connection diagram that you have made the correct connections. Please note that input procedures and program source selection may vary according to the capabilities of the amplifier and the connections between it and the GE-60.

● To connect an integrated amplifier using the ACCESSORY jacks:

The ACCESSORY jacks are provided on some of Yamaha's newest amplifiers and receivers.

1. Connect the SEND jacks of the ACCESSORY jacks to the LINE INPUT of the GE-60.
2. Connect the RECEIVE jacks of the ACCESSORY jacks to the LINE OUTPUT of the GE-60.

The program source selected with the integrated amplifier's input selector can be equalized.

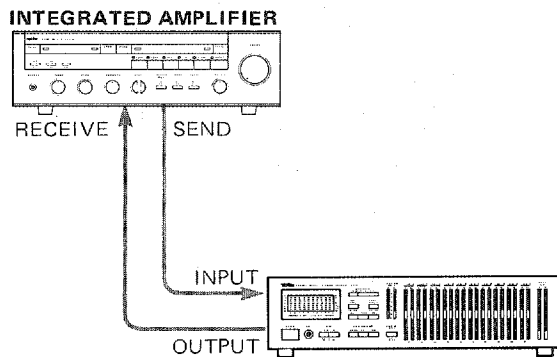

● To connect an integrated amplifier without using the ACCESSORY jacks:

1. Connect the REC OUT jacks of the TAPE jacks to the LINE INPUT of the GE-60.
2. Connect the TAPE PB jacks of the TAPE jacks to the LINE OUTPUT of the GE-60.

The following operations can be carried out via the amplifier:

Amp	Program Source	Setting
With a REC OUT selector	Selected with the REC OUT Selector	Set the INPUT SELECTOR to TAPE
With a TAPE MONITOR switch	Selected with the input selector	Turn the TAPE MONITOR switch ON

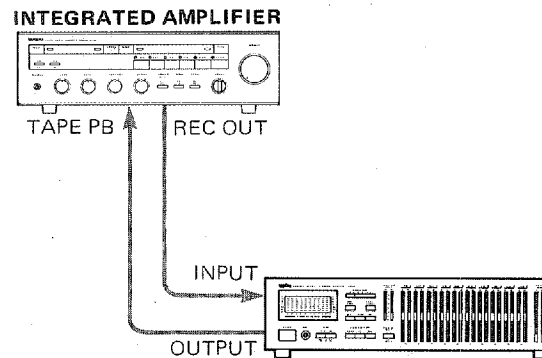

● To connect a separate amplifier:

1. Connect the PRE OUT jacks of the PRE-AMPLIFIER to the LINE INPUT jacks of the GE-60.
2. Connect the MAIN IN jacks of the POWER AMPLIFIER to the LINE OUTPUT jacks of the GE-60.

In this way, you will be able to equalize the program source selected with the PRE-AMPLIFIER'S input selector.

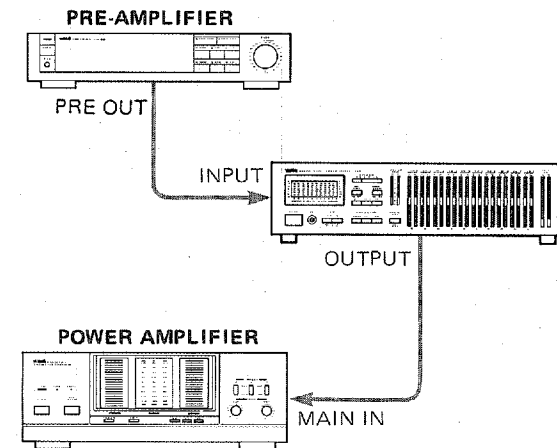

■ CONNECTING A TAPE DECK

Connect the tape deck to the TAPE 1 or TAPE 2 jacks. Connect the TAPE PB jacks to the tape deck's LINE OUT terminal, and the REC OUT jacks to the tape deck's LINE IN jacks.

■ AUXILIARY POWER OUTLET (AC OUTLET)

This is an unswitched auxiliary outlet which can be used to supply power to other audio equipment. The other equipment must have a power consumption rating less than 200W. Power will be supplied even if the GE-60 is turned off.

CAUTION: Always be sure to check that the power consumption of the unit you are connecting is less than 200W.

GE-60

FRONT PANEL PARTS AND FUNCTIONS

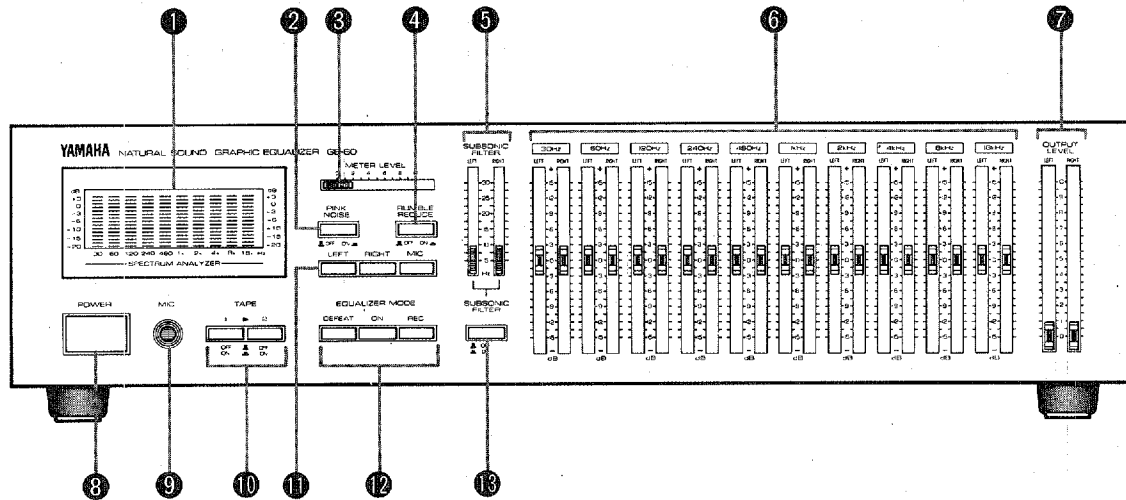

① FREQUENCY SPECTRUM ANALYZER

This frequency spectrum analyzer divides a 30Hz ~ 16kHz frequency range into 10 bands and displays the relative signal level of each band. Since the frequency of each band corresponds to an equalizing control frequency, you can check the equalizing effect directly.

② PINK NOISE Switch

Pink noise, which is emitted by a built-in generator, is a random noise signal which is distributed at an even level at all frequencies, and when monitored through the supplied microphone, allows you to measure the acoustic response characteristics of the listening environment.

③ METER LEVEL Control

This is used to control the level displayed by the spectrum analyzer. No display will appear when the knob is at the "0" position. The variable level display it provides facilitates monitoring a wide range of relative output levels with ease.

④ RUMBLE REDUCE Switch

This switch converts stereo signals below 100Hz to mono signals. By converting the audio signal below a 100Hz level to a mono signal, out-of-phase rumble components in the audio signal are greatly eliminated. Elimination of these low-frequency noise components from the audio signal also improves amplifier operating efficiency.

⑤ SUBSONIC FILTER Controls

These controls permit continuously variable control of the subsonic filter cut-off frequency. They permit both left and right channel control of cut-off frequencies between 5Hz and 30Hz.

This switch lets you cut out ultra-low-frequency signals caused by turntable rumble or warped records without affecting the quality of audible sounds. These subsonic interference signals can sap vital power from the amplifier or even harm speakers if not attenuated.

⑥ EQUALIZATION LEVEL CONTROLS

Independent level controls for both the left and right channels are provided for each of the ten frequency bands. These are sliding type controls, and in the center position provide no level boost or cut. A $\pm 15\text{dB}$ range of equalization is available on each frequency band. Red LED indicators on each control light when the EQUALIZER MODE switches are set to ON, providing visual confirmation of level settings at a glance. When the EQUALIZER MODE switches are set to DEFEAT, these controls will have no effect, regardless of their settings.

● 30 Hz Slide Control

Moving this slide control down reduces very low frequency rumble, or compensates a warped disc. Moving the slide control up emphasizes the very low frequencies.

● 60 Hz Slide Control

Moving the slide control down reduces AC line hum and (reduces) the lower tone. Moving slide control up emphasizes low tones such as pipe organ, drums, bass, etc.

● 120 Hz Slide Control

This range supports the lower end of the music and controls overall depth. The slide control may be moved down to eliminate "boomy bass" caused by room acoustics.

● 240 Hz Slide Control

This is the middle-to-lower tone range, but it has an effect on the overall sound. Mainly, the richness of the strings can be controlled. When strings are overly warm under actual listening conditions, moving the slide control down may help.

● **480 Hz Slide Control**

This range is the foundation of music including both instruments and the human voice and it controls the overall power of the sound. As the slide control is moved up, midrange sounds will become more forward.

● **1 kHz Slide Control**

This range affects the presence of the music (depth of tone), and is especially effective when playing back vocals. Moving the slide control up and down will cause the vocals to be more "up front" or more reserved.

● **2 kHz Slide Control**

This is the frequency range where the human ear is most sensitive. Boosting the level slightly will add brilliance, crispness, etc. to instruments. Cutting the level slightly makes for easy listening.

● **4 kHz Slide Control**

The human ear is also highly sensitive in this range. Mainly effective for increasing/decreasing the harmonics of the primary tone. Boosting this range a bit makes strings more intense. Over-intense, tiresome music becomes easy listening when the slide control is moved down.

● **8 kHz Slide Control**

High frequency range. Strings, horns, etc. will be emphasized and this gives a slight difference in tone glaze and quality. Moving the slide control down reduces over-emphasized consonants in vocals and objectionable tape hiss. Moving the slide control up, on the other hand, improves the sharpness of such instruments as cymbals.

● **16 kHz Slide Control**

Super-high frequency range. This affects higher harmonics rather than the fundamental tones of the instruments themselves, and has an effect on the delicacy and atmosphere of the music. Moving the slide control up adds a delicate, fresh sound to cymbals, triangles, etc.

⑦ **OUTPUT LEVEL Controls**

These control the GE-60's LINE OUTPUT level, with independent control over both left and right channel output. Independent control over left and right channel output level allows you to compensate for left/right level

imbalances either in the source, or due to speaker placement.

*The REC OUT level cannot be changed.

⑧ **POWER Switch**

This switch turns the power to the GE-60 ON and OFF. The switch is pressed once to turn the power on, and a second time to turn the power off.

⑨ **MIC Jack**

This is the input terminal for the microphone to be used with the spectrum analyzer to measure the acoustic response characteristics of the listening environment.

⑩ **TAPE Monitor Selectors**

These are used to select a tape deck for tape monitoring, or to initiate tape dubbing between the two decks.

Program Source Selection	TAPE 1	TAPE 2
To monitor playback of a Tape 1 source	ON	OFF
To monitor playback of a Tape 2 source	OFF	ON
To copy a tape from Tape 1 to Tape 2	ON	ON
To monitor a Non-Tape source	OFF	OFF

⑪ **Meter Select Switches**

This switch is used to select the SPECTRUM ANALYZER display mode.

LEFT, RIGHT: These buttons allow you to independently select a spectrum analyzer display of output level on the left and right channels, respectively. When both buttons are pressed, the spectrum analyzer displays a combined output level of both channels.

MIC: Displays the input signal when the supplied microphone is connected to the MIC jack.

*When the PINK NOISE switch is ON, the LEFT and RIGHT switches can be used to display the pink noise level.

⑫ **EQUALIZER MODE Switches**

Selects the equalization mode.

DEFEAT: No equalization—flat response is achieved.

ON: The equalizer control indicators light up and equalization can be effected.

REC: The signal routed to the Rec Out terminals is equalized.

⑬ **SUBSONIC FILTER Switch**

This switches the subsonic filter on and off to cut frequencies in the 5Hz ~ 30Hz range as selected by the SUBSONIC FILTER controls.

● **SUBSONIC FILTER CHARACTERISTICS**

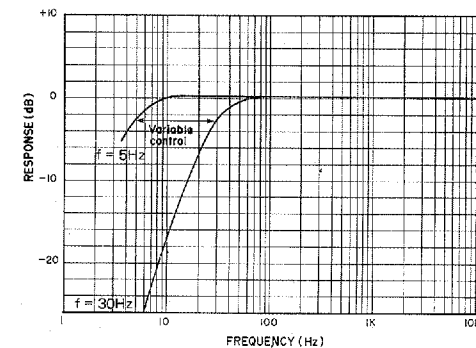

● **EQUALIZATION CHARACTERISTICS**

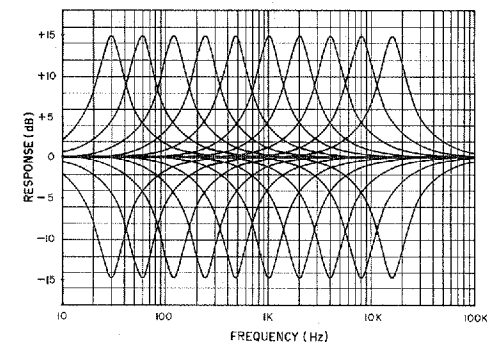

GE-60

• THE MM-60 ELECTRET CONDENSER MICROPHONE

An electret condenser microphone for use in measuring the acoustic response characteristics of the listening environment is provided with the GE-60. Microphone input will be displayed on the spectrum analyzer when the microphone is connected to the front panel MIC jack, the MIC switch is turned on, and a signal of level high enough to be measured is output through the speakers.

*Remove the battery from the microphone if you do not expect to be using it for some time.

Microphone switch

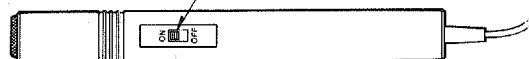

Changing the battery

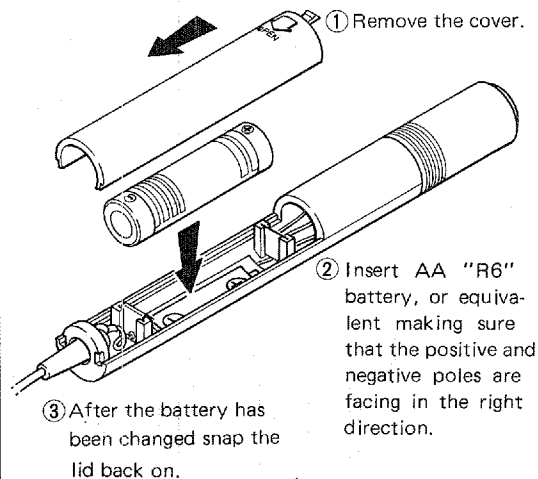

If the battery runs down, the sensitivity of the microphone will decrease. Change the battery as soon as it starts to run down.

THE SPECTRUM ANALYZER

The spectrum analyzer displays the frequency dispersion of signals for direct monitoring. Monitor levels can be adjusted with the METER LEVEL controls for enhanced readability of the level adjustment.

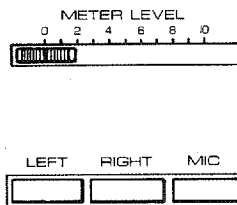

Enhancing Sound Quality

As the equalizer control frequencies are in agreement with the frequency divisions of the spectrum analyzer, equalization effects can be verified visually.

Frequency Dispersion Differs According to the Program Source

- Frequency dispersion in a source with numerous low frequency components

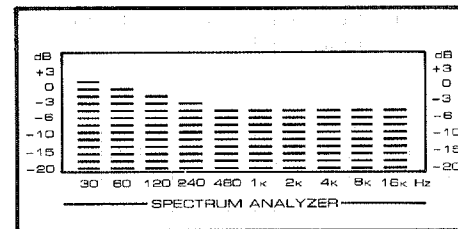

- Frequency dispersion in a source with numerous middle frequency components

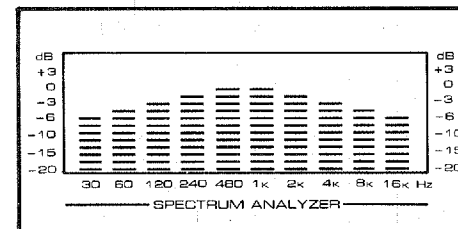

- Frequency dispersion in a source with numerous high frequency components

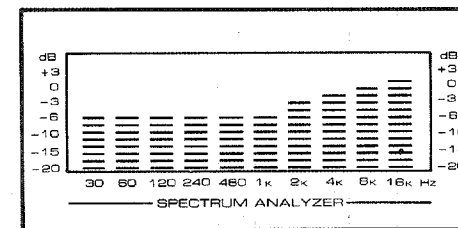

GE-60

OPERATING METHOD

The GE-60 provides control of 10 bands for a total range of 30Hz to 16kHz. Thus, the EQUALIZATION LEVEL controls can be used to finely adjust each frequency as desired.

In addition, by using the built-in pink noise generator and the spectrum analyzer together, the acoustic characteristics of the listening room can be measured and compensated for.

<Before operating:>

- Refer to the respective owner's manuals on how to operate the amplifier, tape deck, and so on.
- Set the tone controls of the connected amplifiers to FLAT or DEFEAT.

■ START PLAY BACK OF THE PROGRAM SOURCE WHICH IS TO BE EQUALIZED

1. Press the POWER switch.
2. Press the EQUALIZER MODE ON switch.

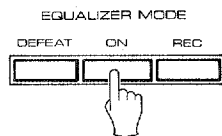

3. Select the program source.

When playing back a program source which is connected to the amplifier, turn the GE-60's TAPE monitor switch OFF. (The procedure for selecting a program source from the amplifier will differ according to the amplifier. Refer to the section on "Connecting the Amplifier.") When using a tape deck connected to the GE-60, set the TAPE monitor selector 1 or 2 to ON.

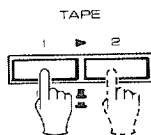
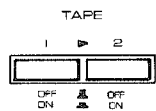

4. Start playback of the program source, and adjust the volume with the amplifier's volume control.
5. Operate the EQUALIZATION LEVEL CONTROLS while listening to the sound in order to obtain the optimum frequency response of the signal.

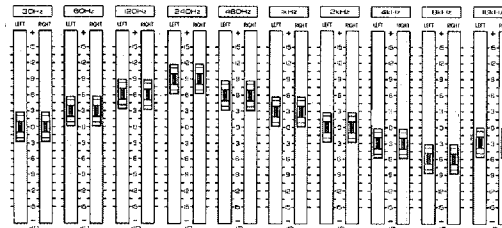

- * Check the effect by alternately pressing the EQUALIZER MODE switch ON and DEFEAT positions.

★ Equalizing record play, etc.

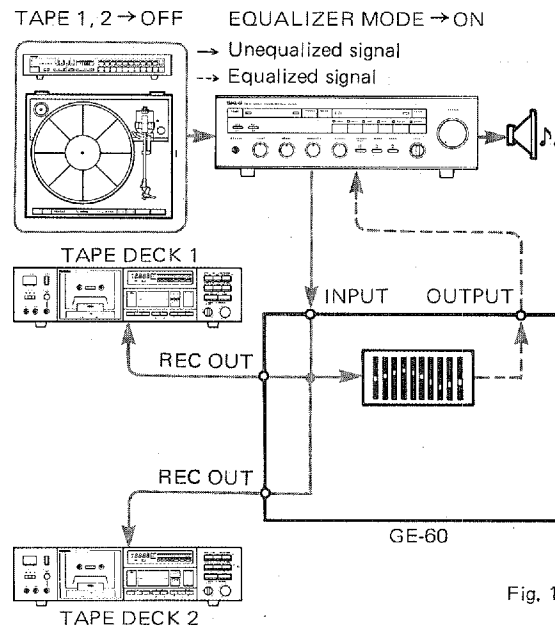

Fig. 1

★ Equalizing a playback from tape deck 1

- TAPE 1 → ON TAPE 2 → OFF → Unequalized signal
 EQUALIZER MODE → ON → Equalized signal

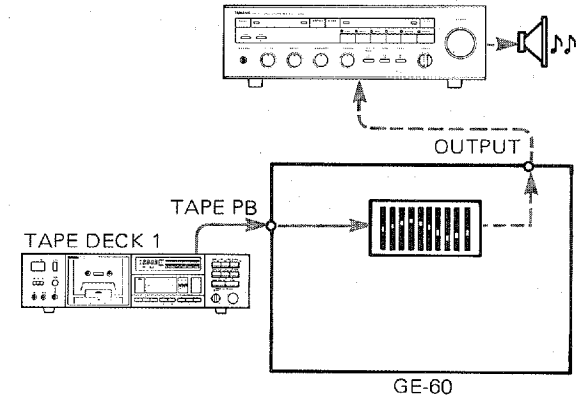

Fig. 2

★ Equalizing a playback from tape deck 2

- TAPE 1 → OFF TAPE 2 → ON → Unequalized signal
 EQUALIZER MODE → ON → Equalized signal

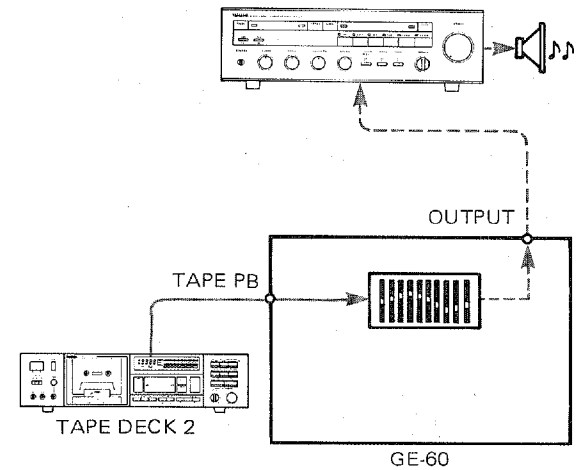

Fig. 3

GE-60

RECORDING AN EQUALIZED PROGRAM SOURCE

An equalized program source can be recorded on a tape deck connected to the TAPE REC jacks of the GE-60.

1. Press the POWER switch.
2. Press the EQUALIZER MODE ON switch.

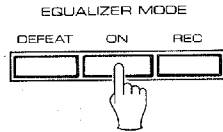

3. Turn the TAPE monitor switches 1 and 2 OFF.

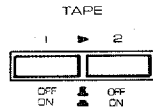

4. Operate the amplifier and select the program source to be recorded.
5. Operate the EQUALIZATION LEVEL CONTROLS to obtain the optimum equalization of the signal.

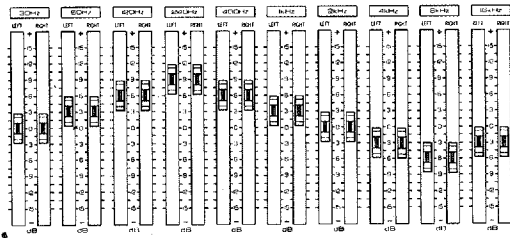

6. Press the EQUALIZER MODE REC switch.

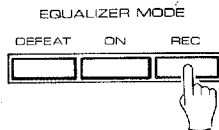

*To record without equalization, turn the REC switch OFF.

7. Adjust the recording level on the tape deck and then begin recording.

Recording an Equalized Program Source

EQUALIZER MODE → ON, REC TAPE 1, 2 → OFF
 → Unequalized signal
 → Equalized signal

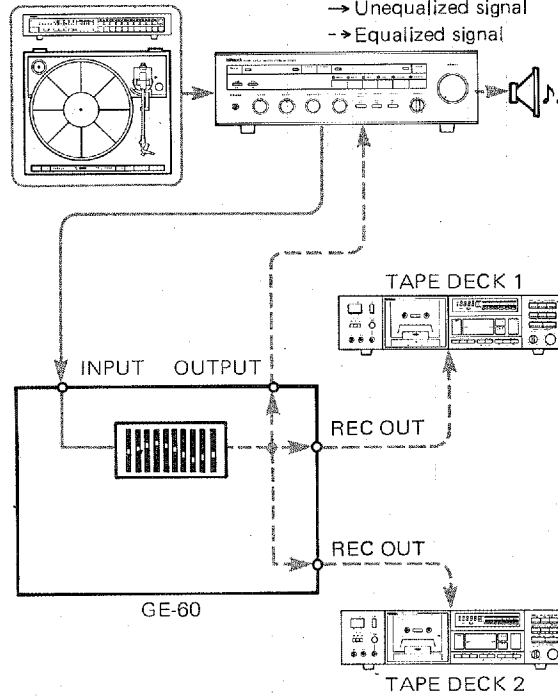

Fig. 4

Tape Monitoring

If you are using a 3-head tape deck, it will be possible to monitor the result of an equalized recording in real time. Set the tape deck's monitor selector to Tape, and the GE-60 Tape 1 or Tape 2 selector to ON.

EQUALIZER MODE → ON, REC TAPE 1 → OFF
 TAPE 2 → ON

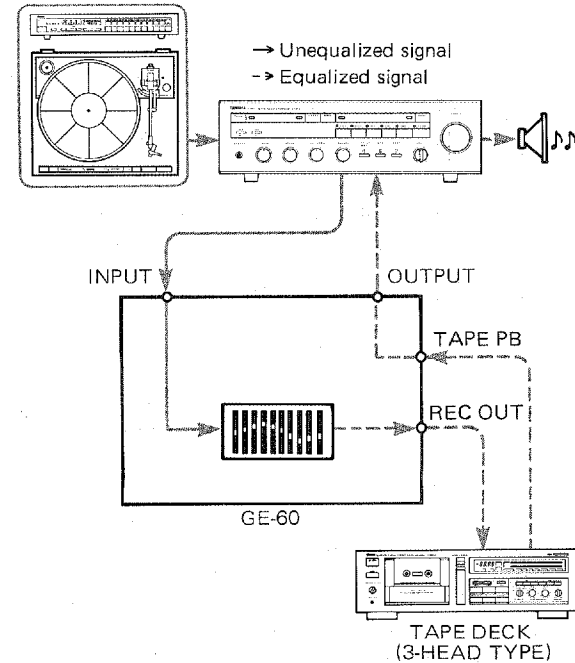
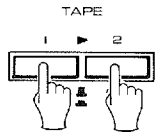

Fig. 5

■ TAPE TO TAPE DUBBING

If you have two tape decks, you can add equalization to an already recorded tape, and copy it to a separate tape.

1. Press the POWER switch.
2. Turn the TAPE monitor switches 1 and 2 ON.



3. Press the EQUALIZER MODE ON switch.

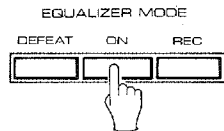

4. Start playback on tape deck 1 and use the EQUALIZATION LEVEL CONTROLS to obtain the optimum equalization of the signal.

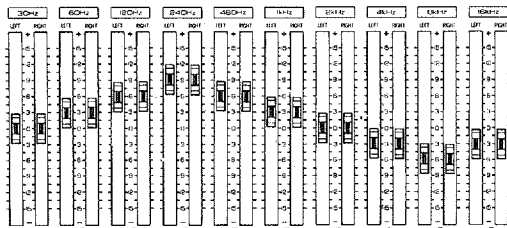

5. Press the EQUALIZER MODE REC switch.
*To record without equalization, turn the REC switch OFF.

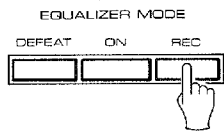

6. Adjust the recording level of tape deck 2 and start tape dubbing copying.

* It is not possible to tape dub from tape deck 2 to tape deck 1.

★ Copying Tapes

TAPE 1, 2 → ON
EQUALIZER MODE → ON, REC
→ Unequalized signal
→ Equalized signal

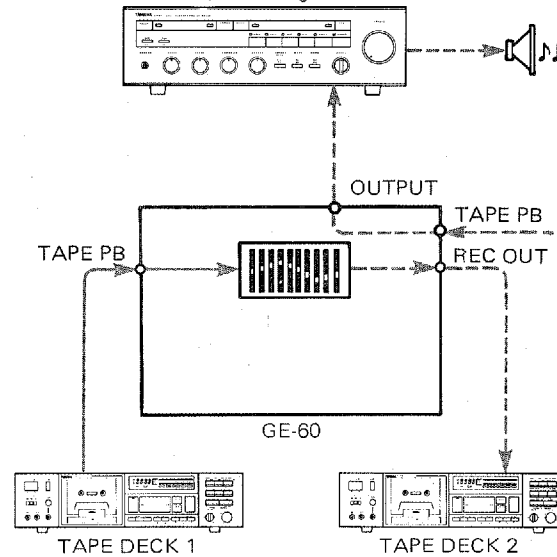

Fig. 6

■ MEASURING AND ENHANCING THE CHARACTERISTICS OF A SOUND ENVIRONMENT

Every room has its own, unique acoustic response characteristics, and your listening environment does influence the sound you are hearing. The GE-60 lets you boost or cut the output level of your music signal at different points of the frequency spectrum, before it reaches your speakers, in anticipation of what the room is going to do it, so the effect of room acoustics on the output signal will be effectively negated.

GE-60

● How to Measure the Acoustic Characteristics of the Listening Room:

1. Connect the microphone supplied as an accessory. Microphone placement is crucial to proper equalization. The microphone position should correspond as closely as possible to where your ears will be when listening. Height of the microphone is thus also a factor.

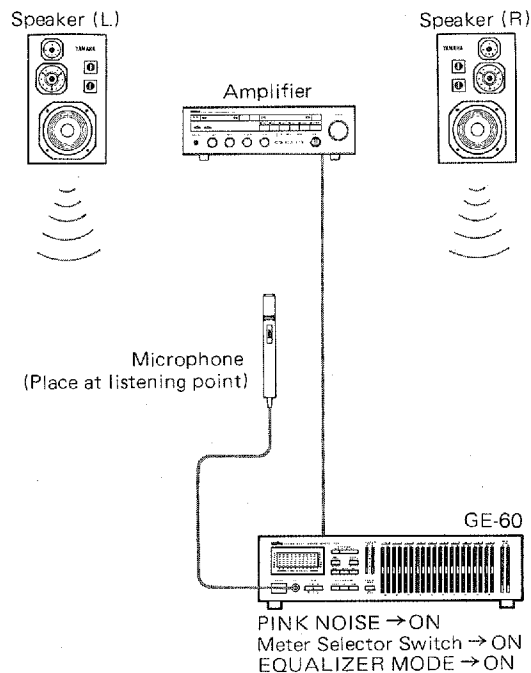

2. Set the control knobs to the following positions:

Amp	Volume control	→ Lowest
	Tone Control	→ Flat
GE-60	OUTPUT LEVEL	→ Maximum (10)
	EQUALIZER CONTROLS	→ Center (0)
	SUBSONIC FILTER	→ OFF
	EQUALIZER MODE	→ DEFEAT
	Meter Select Switch	→ MIC, LEFT, RIGHT
	RUMBLE REDUCE	→ OFF
	PINK NOISE	→ ON
	METER LEVEL	→ Maximum (10)
	TAPE Monitor Switch	→ OFF
Mic	Mic Switch	→ ON

3. When the volume of the amplifier is gradually raised, a buzz will be heard from the speakers. This is pink noise. Set the volume at an acceptable listening level. At this point, if the level indicated by the spectrum analyzer is too high, turn the METER LEVEL knob down bit by bit, and adjust until all displayed levels are a little above the center.

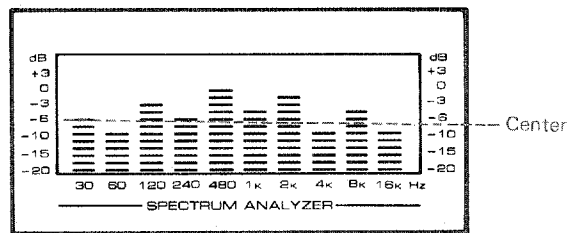

● Compensating for deficiencies in the Listening Environment

1. Press the EQUALIZER MODE ON switch.
2. Turn the LEFT meter select switch off. (Equalizing adjustment is carried out channel by channel with a final overall adjustment.)
3. Start playback through the RIGHT channel. The spectrum analyzer will indicate the response of that channel.
4. Operate the EQUALIZE CONTROL knobs for the RIGHT channel, adjusting them until the spectrum analyzer display is flat.
5. Turn the RIGHT meter select switch off and the LEFT switch on. Proceed as for the RIGHT channel adjustment in step 4.
6. Turn the Meter Select Switches for both channels on.
7. Start playback through both channels simultaneously, and recheck and readjust the spectrum analyzer. This completes the overall sound enhancement procedure.

TROUBLESHOOTING

Before assuming that your amplifier is faulty, check by following troubleshooting list which details corrective action which you can take yourself. If the fault persists, or is not mentioned in the list, turn off and disconnect your GE-60 immediately, and get in touch with your nearest Yamaha dealer.

Fault	Cause	Cure
Power is not supplied even though the Power switch is turned on.	<ul style="list-style-type: none"> • The power plug is not securely plugged in. 	<ul style="list-style-type: none"> • Plug it in securely.
No sound is heard.	<ul style="list-style-type: none"> • The TAPE monitor switch is not set correctly. • The OUTPUT LEVEL controls are set too low. • Improper connections to INPUT jacks. 	<ul style="list-style-type: none"> • Set the switch correctly. • Move the OUTPUT LEVEL controls. • Make sure all connections are properly done.
There is no sound from one speaker.	<ul style="list-style-type: none"> • The left or right OUTPUT LEVEL control are set too low. 	<ul style="list-style-type: none"> • Adjust the OUTPUT LEVEL control correctly.
	<ul style="list-style-type: none"> • The pin plug is not properly connected. 	<ul style="list-style-type: none"> • Check the connections.
Sound quality cannot be enhanced.	<ul style="list-style-type: none"> • The EQUALIZER MODE switch is in the DEFEAT position. 	<ul style="list-style-type: none"> • Set the switch to ON.
Spectrum analyzer will not light up.	<ul style="list-style-type: none"> • The METER LEVEL control is set to 0. 	<ul style="list-style-type: none"> • Slide the METER LEVEL control to the right.
	<ul style="list-style-type: none"> • The spectrum analyzer switch is not set properly. 	<ul style="list-style-type: none"> • Set the switch correctly.

GE-60

BLOCK DIAGRAM

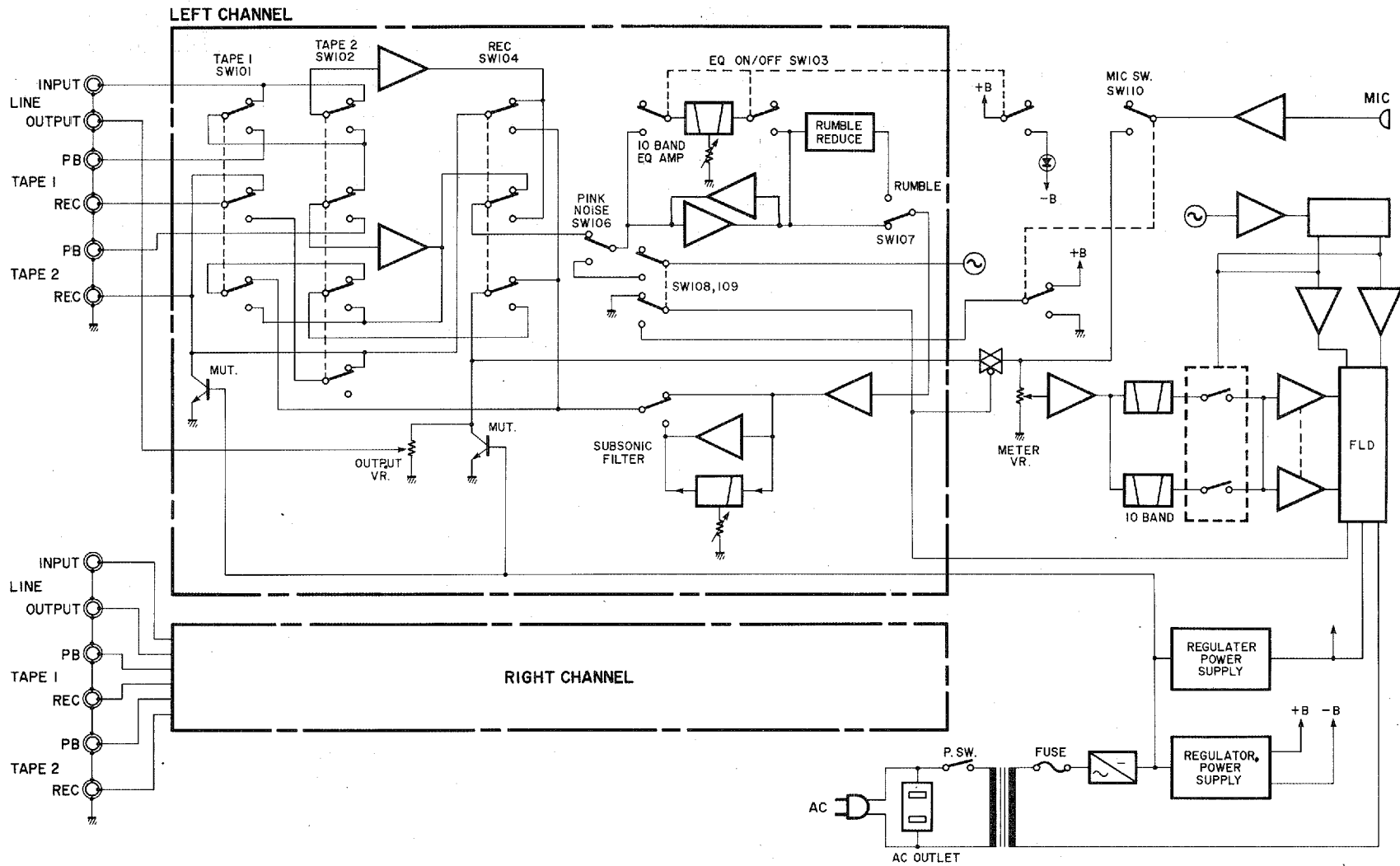

SPECIFICATIONS

Input Sensitivity/Impedance

LINE IN, TAPE 1V/47k-ohms
 MIC 0.3mV/47k-ohms

Rated Output/Impedance

LINE OUT, REC OUT . . . 1V/600-ohms
 (OUTPUT LEVEL → Max.)

Frequency Response 10Hz ~ 100kHz, +0.5 - 1dB

Center Frequencies 30Hz, 60Hz, 120Hz,
 240Hz, 480Hz, 1kHz,
 2kHz, 4kHz, 8kHz,
 16kHz.

Equalizer Control Range . . ±15dB

Signal-to-Noise Ratio (Input short, IHF A Network)

At 1V output 110dB

Total Harmonic Distortion

(20Hz ~ 20kHz,
 1V output) 0.005%

Maximum Output (0.1%) . . . 10V

Subsonic Filter Cutoff

Frequency 5Hz ~ 30Hz (Continuous-
 ly variable) 12dB/Oct

Rumble Reduce Converts stereo signals
 below 100Hz to mono

Pink Noise Output 150mV RMS

Display 10 bands
 Switchable between L or
 R, L + R, MIC

Power Supply AC120V 60Hz

Power Consumption 13W

Dimensions (W x H x D) 435 x 112 x 275 mm
 (17-1/8" x 4-7/16" x 10-13/16")

Weight 4.4 kg (9 lbs. 11 oz.)

Accessories Pin plug cords (2)
 MM-60 Electret Condenser Mic
 Mic stand
 Dry battery "AA", "R-6" type (1)

**Specifications subject to change without notice.*

■ ATTACHING THE RACK MOUNTING ADAPTORS (Optional)

- 1) Remove the screws on each side of the unit as shown in the diagram and take off the covers which conceal the adaptor mounting holes.
- 2) Verify that the resulting mounting centers of the adaptors will match the width of your rack, then attach the adaptors firmly with screws.

* Using these adaptors allows the unit to be used with EIA standard racks.

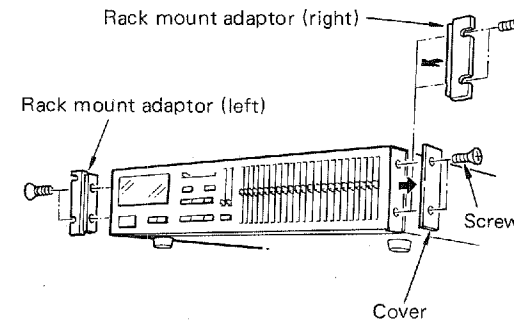

YAMAHA

SINCE 1887  **YAMAHA**
NIPPON GAKKI CO., LTD. HAMAMATSU, JAPAN