

---

DIGITAL KEYBOARD

# REFERENCE MANUAL

---

## EZ-310

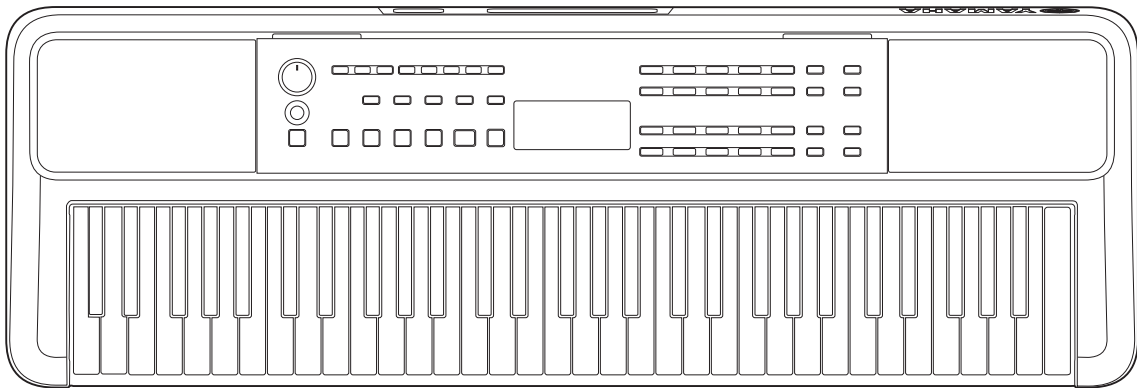

## About the Manuals

---

The following manuals are provided for the instrument.



- **Owner's Manual (printed manual included in the package)**

Explains the basic operations of the instrument. The manual also includes a Precautions section that you must read before use.

- **Reference Manual (this document)**

Explains all functions of the instrument are provided.

### General contents of the notes

 <b>WARNING</b>	Important information to avoid the possibility of serious injury or even death from electrical shock, short-circuiting, damages, fire or other hazards.
 <b>CAUTION</b>	Important information to avoid the possibility of physical injury to you or others, or damage to the instrument or other property.
<b>NOTICE</b>	Important information to avoid the possibility of malfunction or damage to the product, damage to data, or damage to other property.
 <b>NOTE</b>	Helpful information and tips.

- **Data List**

Contains various important preset content lists such as Voices, Songs, Styles, etc., as well as MIDI-related information of this instrument.

- **Smart Device Connection Manual**

Explains how to connect the instrument to smart devices, such as smartphones, tablets, etc.

### Downloadable Song Book



**SONG BOOK**

This contains music scores for the preset Songs (excluding some Songs) of this instrument. This is available as a free download from the following website.

<https://manual.yamaha.com/mi/kb-ekb/ez-310/downloads/>



- **Video Manual**

Video manuals explaining how to use this instrument are available.



Scan the QR code to the left or access the website below.

<https://manual.yamaha.com/mi/kb-ekb/ez-310/videos/>

## Included Accessories

---

- Owner's Manual (this book) ×1
- Music rest ×1
- AC adaptor\* ×1
- Online Member Product Registration ×1

\* May not be included depending on your particular locale. Check with your Yamaha dealer.

# Contents

---

About the Manuals .....	2
Included Accessories .....	2
Information.....	5
Formats and Functions .....	5
<b>Setting Up</b> .....	<b>6</b>
Power Requirements .....	6
Turning the Power On/Off.....	7
Auto Power Off function.....	7
Using the Music Rest .....	7
<b>Panel Control and Terminals</b> .....	<b>8</b>
<b>Basic Operations</b> .....	<b>12</b>
Selecting a Voice/Song/Style.....	13
Lighting Keyboard (Light Guide Function) .....	15
Changing the Tempo .....	15
Using the Metronome .....	16
<b>Display Items</b> .....	<b>17</b>
<b>Playing a Variety of Instrument Voices</b> .....	<b>18</b>
Selecting a Main Voice .....	18
Calling up the Grand Piano Voice.....	18
Layering another Voice over the entire keyboard (Dual) .....	19
Playing Different Voices with Your Left and Right Hands (Split) .....	20
Changing the Touch Response of the Keyboard .....	21
Adding Articulation Effects .....	22
Adding Harmony or Arpeggio .....	23
Synchronizing an Arpeggio to Song/Style Playback (Arpeggio Quantize) .....	25
<b>Adding Effects to Performances and playback</b> .....	<b>26</b>
Adding DSP Effects.....	26
Selecting a Reverb Type .....	27
Selecting a Chorus Type .....	27
Selecting an EQ setting for your favorite sound .....	28
Adding Sustain.....	28
<b>Playing the keyboard with Two People (Duo)</b> .....	<b>29</b>
<b>Playing with Rhythm and Auto Accompaniment (Styles)</b> .....	<b>30</b>
Specify the Chords Automatically (Auto Chord Play) .....	30
Setting the Fingering Type.....	31
Setting the Style Key .....	31
Playing while Specifying the Chords.....	32
Style Variations (Sections) .....	33
How to play Chords for Style Playback .....	35
Chords Produced When Smart Chord is Selected .....	36
Using the Music Database .....	37
Registering a Style File.....	37

<b>Playing Back Songs</b>	<b>38</b>
Selecting and Playing Back a Song .....	39
Playing Back Songs in Sequence .....	39
Selecting the level of the left-hand part.....	40
Song Fast Forward, Fast Reverse, and Pause .....	40
Changing the Song Melody Voice .....	40
A-B Repeat Playback .....	41
Turning Each Part of the Song On/Off.....	41
Copying Songs from a Computer to this Instrument.....	41
<b>Practicing the Timing and Touch of Playing the Keyboard (Rhythm &amp; Touch Tutor)</b>	<b>42</b>
<b>Using the Song Lesson Feature</b>	<b>43</b>
Keys To Success .....	44
3-Step Lesson (Listen, Timing, and Waiting) .....	47
<b>Recording Your Performance</b>	<b>49</b>
Recording a New User Song .....	49
Recording to a Specified Part (Track).....	50
Clearing a User Song .....	51
<b>Memorizing Your Favorite Settings (Registration Memory)</b>	<b>52</b>
Recalling Panel Settings from the Registration Memory .....	52
Memorizing Panel Settings to Registration Memory.....	53
Deleting a Registration Memory .....	53
Disabling Recall of Specific Items (Freeze).....	53
<b>Connecting to Other Devices</b>	<b>54</b>
Connecting Headphones or External Speakers (sold separately) .....	54
Using a Pedal (Footswitch).....	54
Playing an Audio Device with this instrument.....	55
Connecting to a Computer via USB .....	56
Connecting a Smart Device.....	59
Lowering the volume of a melody part (Melody Suppressor function).....	59
<b>The Functions</b>	<b>60</b>
<b>Backup and Initialization</b>	<b>66</b>
Backup data and Backup settings.....	66
Initializing the instrument.....	66
<b>Troubleshooting</b>	<b>67</b>
<b>Specifications</b>	<b>69</b>
<b>Index</b>	<b>71</b>

## Information

---

- The illustrations and LCD screens as shown in this manual are for instructional purposes only.
- “QR Code” is a registered trademark of DENSO WAVE INCORPORATED.
- The company names and product names in this manual are the trademarks or registered trademarks of their respective companies.

## Formats and Functions

---



### GM System Level 1

“GM System Level 1” is an addition to the MIDI standard which ensures that any GM-compatible music data can be accurately played by any GM-compatible tone generator, regardless of manufacturer. The GM mark is affixed to all software and hardware products that support GM System Level.



### XGlite

As its name implies, “XGlite” is a simplified version of Yamaha’s high-quality XG tone generation format. Naturally, you can play back any XG song data using an XGlite tone generator. However, keep in mind that some songs may play back differently compared to the original data, due to the reduced set of control parameters and effects.



### Style File Format (SFF)

The Style File Format combines all of Yamaha’s auto accompaniment know-how into a single unified format.



### Touch Response

The exceptionally natural Touch Response feature gives you maximum expressive control over the level of the Voices.

# Setting Up

## Power Requirements

Although the instrument will run either from an AC adaptor or batteries, Yamaha recommends the use of an AC adaptor whenever possible.

### ■ Using an AC Adaptor

Connect the AC adaptor in the order shown in the illustration.

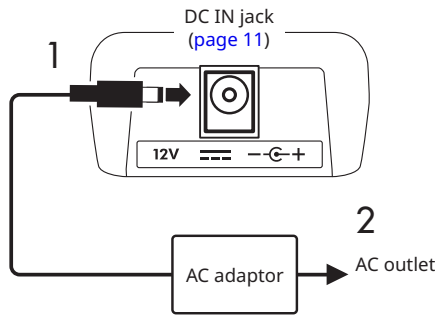

### ⚠ WARNING

- Use only the supplied or THE specified AC adaptor (page 70).
- When using an AC adaptor with a removable plug, make sure to keep the plug attached to the AC adaptor during use and storage. Inserting just the plug into an outlet can cause electric shock or fire.
- Never touch the inner metallic section of the plug to avoid electric shock, short circuit, or damage. If the plug comes off, push it in until it securely clicks in place. Also be careful that there is no dust or other foreign matter between the AC adaptor and plug.

When using the AC adaptor with a removable plug

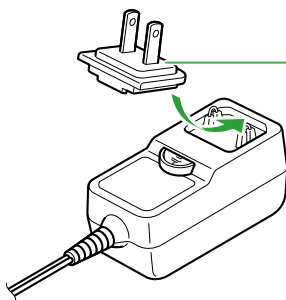

#### Plug

- Place the plug against the far side, and then firmly push it in until it clicks.
- The shape of the plug differs depending on your area.

- When setting up the instrument, make sure that the AC outlet you are using is easily accessible. If trouble or a malfunction occurs, immediately turn the power off and disconnect the plug from the outlet.

#### NOTE

- When disconnecting the AC adaptor, turn off the power of the instrument and follow the order shown above in reverse.

### ■ Using Batteries

This instrument can use AA size alkaline, manganese dry cell, or rechargeable nickel metal hydride batteries (rechargeable batteries). However, the use of alkaline or rechargeable batteries is recommended, as the instrument may consume large amounts of power depending on use.

### ⚠ WARNING

- Before installing batteries, make sure to refer to the "Batteries" section in the Precautions of the Owner's Manual.

- 1 Make sure that the power of the instrument is off.
- 2 Open the battery compartment cover located on the instrument's bottom panel.

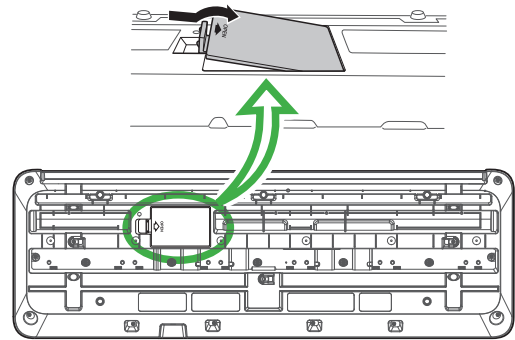

- 3 Insert the six new batteries, being careful to follow the polarity markings on the inside of the compartment.

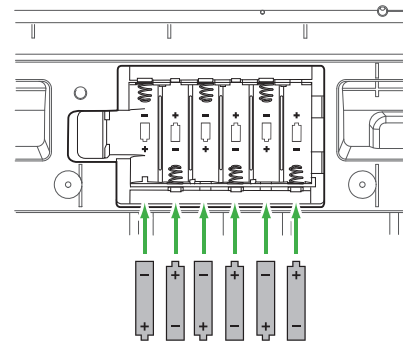

- 4 Replace the compartment cover, making sure that it locks firmly in place.
- 5 After turning the power of the instrument on, make sure to set the battery type correctly (page 7).

**NOTICE**

- Connecting or disconnecting the power adaptor with batteries inserted may turn the power off, resulting in loss of data being recorded at the time.
- When battery power becomes too low for proper operation, the volume may be reduced, the sound may be distorted, and other problems may occur. When this happens, make sure to replace all batteries with new ones or already recharged ones.

**NOTE**

- This instrument cannot charge the batteries. Use only the specified charger device when charging.
- Even if batteries are inserted into the instrument, the AC adaptor will be used as the power source when the AC adaptor is connected.

**Setting the battery type**

You need to change the battery type setting on this instrument, depending on the battery type to be used. To change the setting, after turning the power on, set the battery type via Function number 066 (page 65).

*Default setting: Alkaline*

Alkaline	Alkaline batteries, manganese dry batteries
Ni-MH	Rechargeable nickel metal hydride batteries (rechargeable batteries)

**NOTICE**

- Failure to set the battery type may shorten the amount of the battery life. Make sure to set the battery type correctly.

**Turning the Power On/Off**

1 Turn down the [MASTER VOLUME] dial to "MIN".

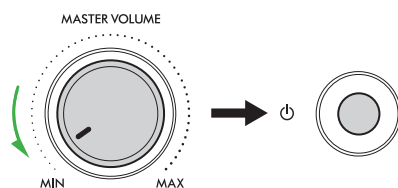

2 Press the [⏻] (Standby/On) switch to turn the power on.  
The display will light up.

3 Adjust the volume as desired while playing the keyboard.

4 Press and hold the [⏻] (Standby/On) switch for about a second to turn the power off.

**WARNING**

- Even when the power is turned off, electricity is still flowing to the instrument in a small amount. Remove the electric plug from the outlet when the instrument is not to be used for extended periods of time or during electrical storms.

**NOTICE**

- Press only the [⏻] (Standby/On) switch when turning the power on. Any other operations such as pressing keyboards/buttons or stepping on the footswitch may cause the instrument to malfunction.

**Auto Power Off function**

The instrument will automatically turn off after 15 minutes of inactivity. However, you can change this setting on the Function setting display (page 65, Function number 065).

**Easy deactivation of the Auto Power Off function**

Turn the power on while holding down the lowest key on the keyboard. The message "AutoOff Disabled" will appear briefly, and then the instrument will start up with the Auto Power Off function disabled.



**Using the Music Rest**

Insert the music rest into the slots as shown.

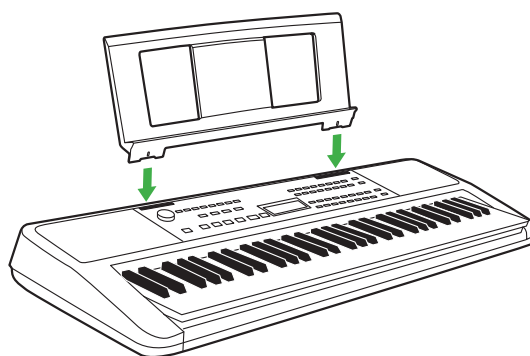

# Panel Control and Terminals

## ■ Front Panel

**About the alternate button names enclosed in the frame** (15) (23) [SHIFT] )

If you operate one of the buttons while holding down [SHIFT], the function indicated in the frame below the button will be executed. For example, holding down (15) [SHIFT] and pressing (5) [METRONOME] calls up the Time Signature setting display.

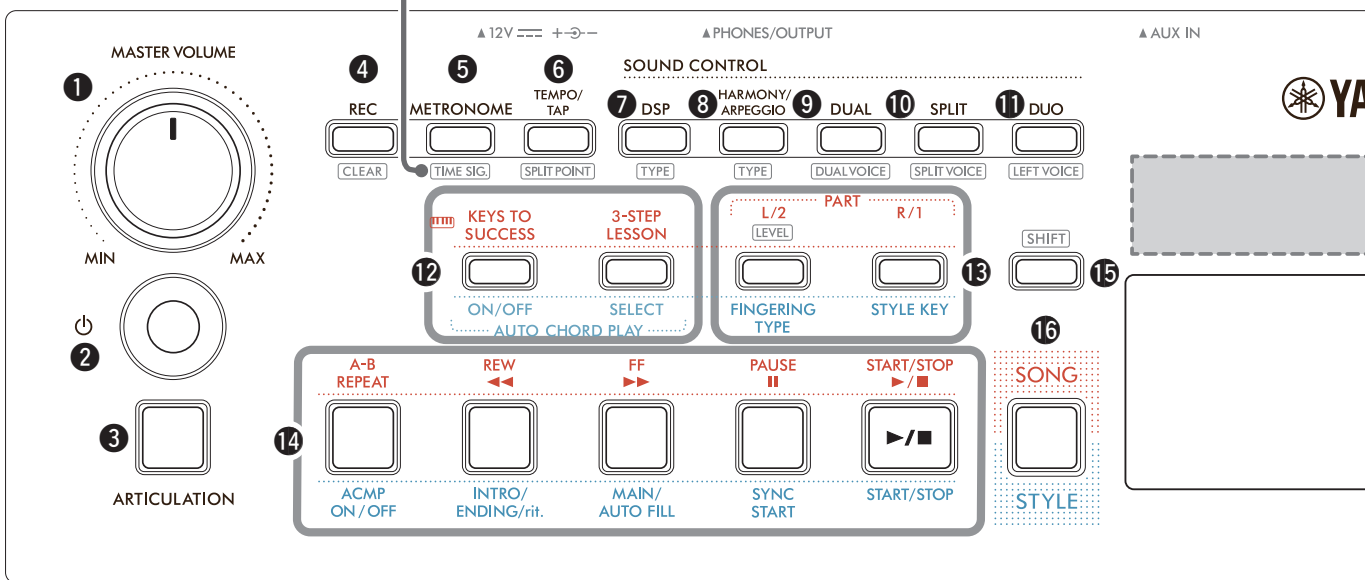

- 1 [MASTER VOLUME] dial** ..... [page 7](#)  
Adjusts the overall volume.
- 2 [⏻](Standby/On) switch** ..... [page 7](#)  
Switches between standby and power on.
- 3 [ARTICULATION] button**..... [page 22](#)  
Recreates the characteristic performance techniques for specific instruments.
- 4 [REC] button** ..... [page 49](#)  
Records your performance.  
CLEAR ..... [page 51](#)  
Clears a User Song.
- 5 [METRONOME] button** ..... [page 16](#)  
Starts/stops the metronome.  
TIME SIG. ..... [page 16](#)  
Lets you set the time signature of the metronome on the setting display.
- 6 [TEMPO/TAP] button**..... [page 15](#)  
Lets you set the tempo of the Song/Style/metronome.  
SPLIT POINT ..... [pages 20, 29, 32](#)  
Lets you determine the point for dividing the keyboard into left and right areas (Split Point) when using Duo and Style.
- 7 [DSP] button** ..... [page 26](#)  
Switches the DSP (digital signal processor) on or off.  
TYPE ..... [page 26](#)  
Lets you select the type of DSP.
- 8 [HARMONY/ARPEGGIO] button**..... [page 23](#)  
Adds effects such as harmony, etc. or enables the Arpeggio function.  
TYPE ..... [page 23](#)  
Lets you select the HARMONY/ARPEGGIO type.
- 9 [DUAL] button** ..... [page 19](#)  
Layers another Voice over the entire keyboard as a Dual Voice.  
DUAL VOICE ..... [page 19](#)  
Lets you select the Voice for layering.
- 10 [SPLIT] button** ..... [page 20](#)  
Divides the keyboard into two separate areas, allowing you to play different Voices in the Left-hand and Right-hand areas.  
SPLIT VOICE ..... [page 20](#)  
Lets you select the Voice for playing in the area lower than the Split point.
- 11 [DUO] button**..... [page 29](#)  
Lets two players play the instrument simultaneously over the same octave range with the same Voice.  
LEFT VOICE ..... [page 29](#)  
Lets you select the Voice for the left player area.



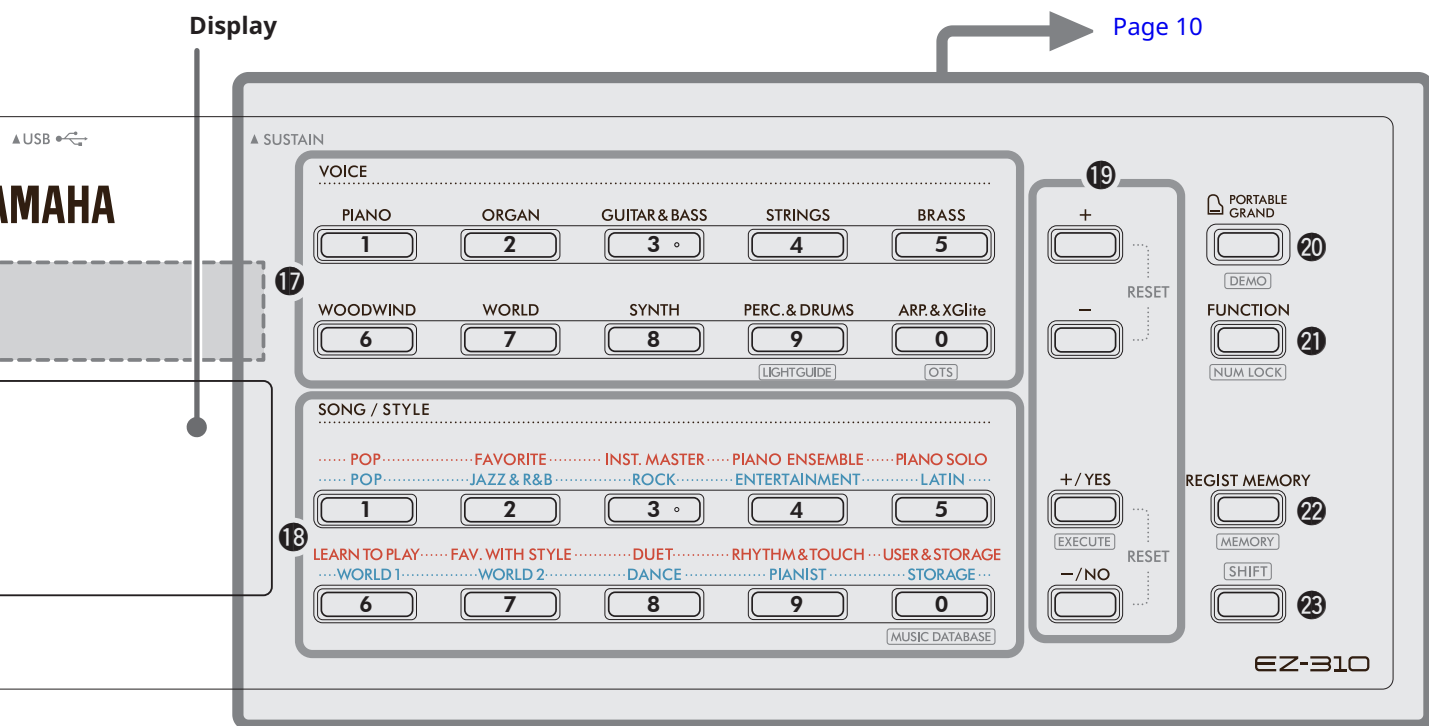

**In the Song mode**

- 12 [KEYS TO SUCCESS], [3-STEP LESSON] buttons ..... [pages 44, 47](#)  
Turns on/off the “Keys To Success” lesson for practicing a Song or starts/stops the “3-Step Lesson” or select the lesson mode.
- 13 PART [L/2], [R/1] buttons ..... [pages 41, 50](#)  
Lets you select a lesson part or muted part of the current Song, or specify the part as a recording target.  
[LEVEL] ..... [page 40](#)  
For changing the Song level of left-hand part.
- 14 Song control buttons ..... [pages 39, 42](#)  
For controlling Song playback.

**In the Style mode**

- 12 AUTO CHORD PLAY [ON/OFF], [SELECT] buttons ..... [page 30](#)  
Turns on/off the Auto Chord Play function or lets you select chord progressions when using the function.
- 13 [FINGERING TYPE], [STYLE KEY] buttons ..... [page 31](#)  
Lets you set how to play chords.
- 14 Style control buttons ..... [pages 30, 32, 33](#)  
For controlling Style playback.
- 15 [SHIFT] button ..... [pages 8, 17](#)  
For the main use of this button, see the explanation in the box at the top of [page 8](#).  
This button also can be used for returning operation to the home display ([page 17](#)).
- 16 [SONG]/[STYLE] button ..... [pages 12, 13, 14](#)  
Switches between Style mode and Song mode.

■ Front Panel

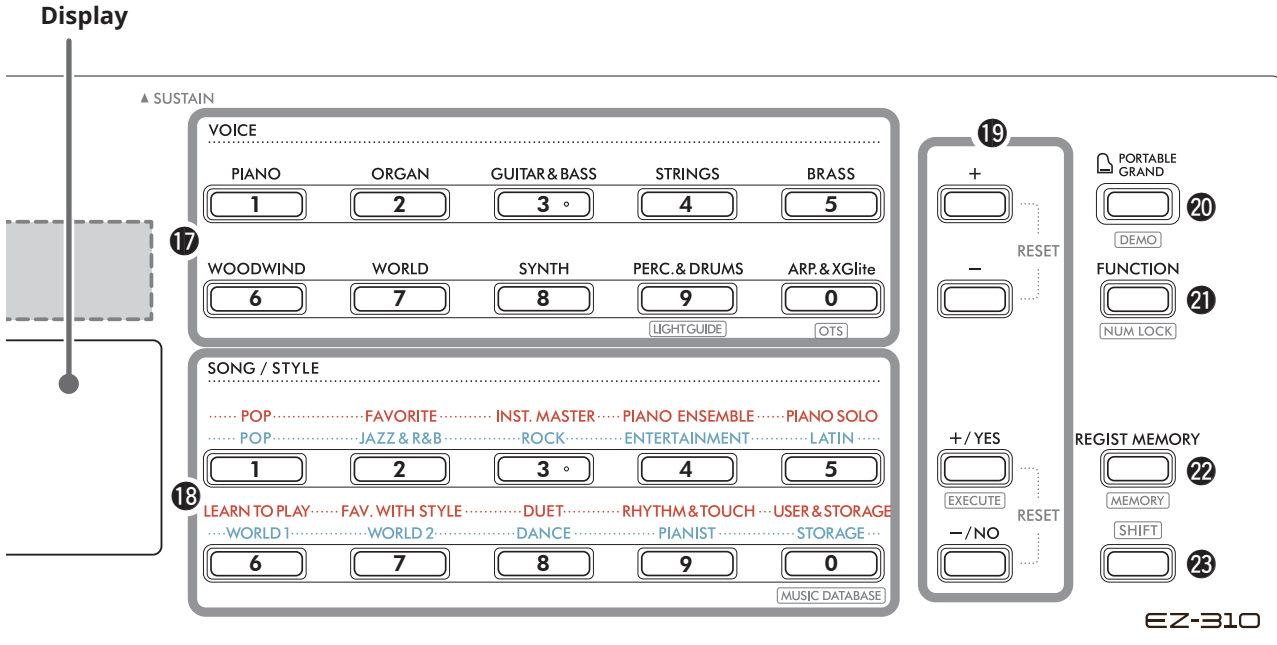

**17 VOICE Category buttons** ..... [pages 12, 13, 18](#)

Lets you select the desired Voice.  
Pressing **21** [FUNCTION] while holding down **23** [SHIFT] allows you to enter Voice numbers or set values, etc. with these buttons.

**LIGHTGUIDE** ..... [page 15](#)

Lets you set the Light Guide function on/off.

**OTS (One Touch Setting)** ..... [page 18](#)

Automatically selects the most suitable Voice when you select a Style or Song (excepting Songs that have been input from other devices).

**18 SONG/STYLE Category buttons** ..... [pages 12, 13, 32, 39](#)

Lets you select the desired Song/Style.  
Pressing **21** [FUNCTION] while holding down **23** [SHIFT] enables you to use these buttons as numeric buttons, in the same way as **17** Voice Category buttons.

**MUSIC DATABASE** ..... [page 37](#)

Lets you call up panel settings such as Voice and Style by selecting the music genre.

**19 [+]/[-] buttons, [+/YES]/[-/NO] buttons** ..... [pages 13, 60](#)

Select items or Increase/Decrease values.  
Pressing the two buttons simultaneously resets the value to the default.

**EXECUTE** ..... [page 58](#)

Executes operations when registering the Style files copied from the computer to this instrument.

**20 [PORTABLE GRAND] button** ..... [page 18](#)

Automatically selects Voice Number 001 "Live! Concert Grand Piano" for the Voice.

**DEMO** ..... [page 39](#)

Starts/stops continuous DEMO & Preset Song playback.

**21 [FUNCTION] button** ..... [page 60](#)

Calls up the Function setting display.

**NUM LOCK** ..... [pages 14, 60](#)

Lets you use the **17** or **18** buttons as Number buttons.

**22 [REGIST MEMORY] button** ..... [page 52](#)

Lets you recall the panel setting you memorized.

**MEMORY** ..... [page 53](#)

Lets you memorize the panel setting.

**23 [SHIFT] button (same as the button 15)**

For the main use of this button, see the explanation in the box at the top of [page 8](#).

This button also can be used for returning operation to the home display ([page 17](#)).

## ■ Rear Panel

The cable to be used depends on the device to be connected.

### Connection Options

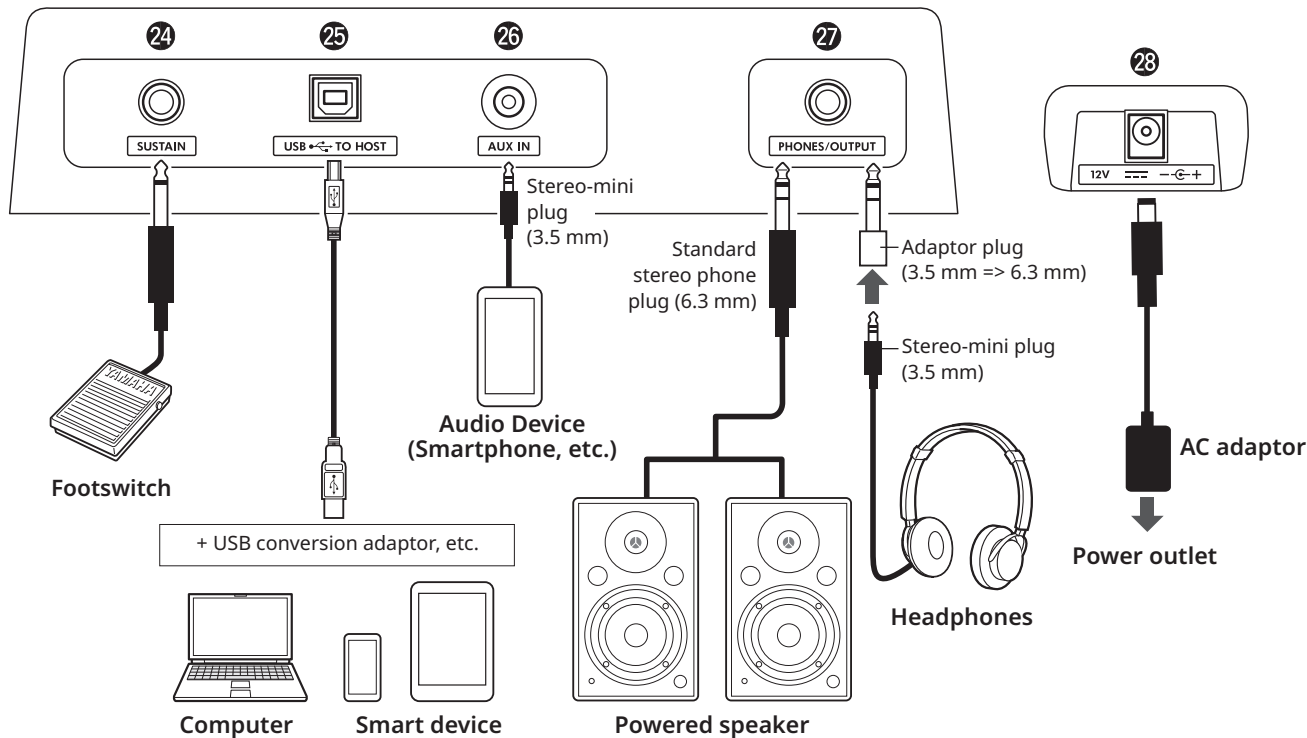

**24 [SUSTAIN] jack..... page 54**

You can connect a separately sold footswitch. The footswitch can be used as a sustain pedal.

**25 [USB TO HOST] terminal.....pages 56, 59**

For connecting to the computer or smart device such as a tablet or smartphone via a USB cable. You can transfer MIDI files or send/receive audio data between this instrument and a computer, or playback the commercially available Song data transferred from computer on this instrument. In addition, using the smart device apps enables you to use the various function.

**NOTICE**

- Use an AB type USB cable of less than 3 meters. USB 3.0 cables cannot be used.

**26 [AUX IN] jack..... page 55**

For connecting an audio device such as a smartphone. You can output the sound of the audio device through the instrument's speakers and play the keyboard along with the playback of the device.

**27 [PHONES/OUTPUT] jack ..... page 54**

For connecting a pair of headphones or an external speaker such as a powered speaker, computer, or keyboard amplifier. The speakers of this instrument are automatically shut off when a plug is inserted into this jack.

**28 DC IN jack..... page 6**

For connecting the AC adaptor.

# Basic Operations

This instrument features three basic functions: Voice, Song, and Style. Select either the Song or Style mode, and then select the desired Voice, Song or Style for your performance.

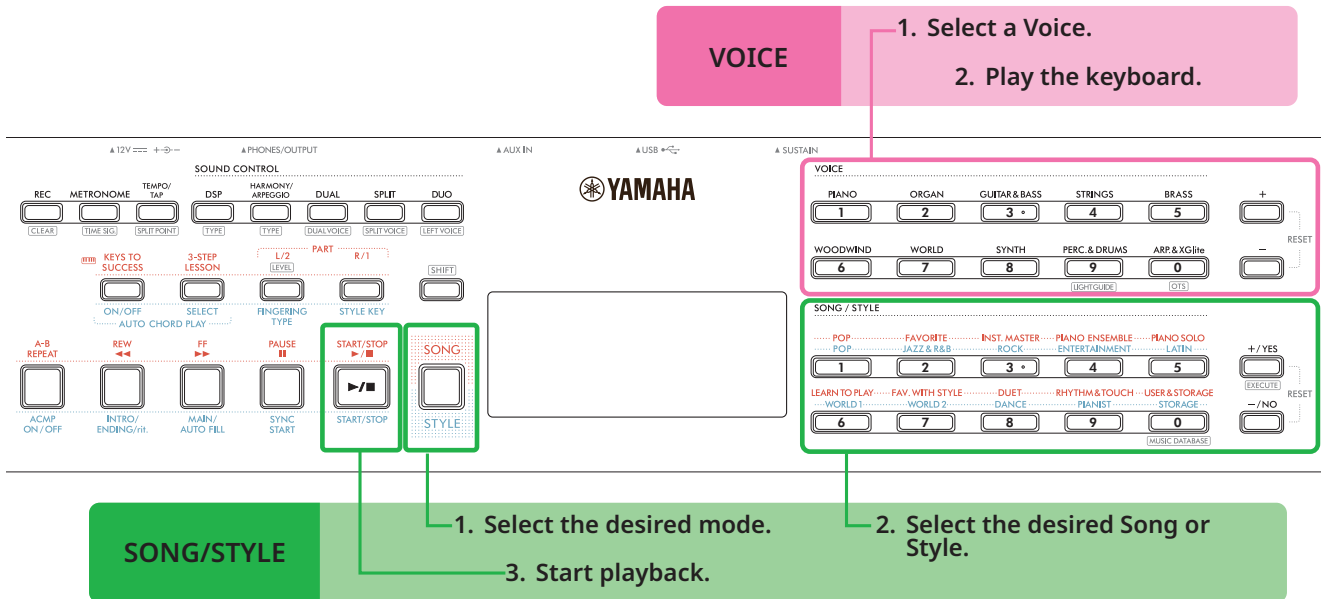

## VOICE

### 1 Select a Voice.

The following three operations are available.

- Selecting from the VOICE category buttons
- Selecting via the [+]/[-] buttons
- Selecting via number input

For detailed instructions, see [pages 13 and 14](#).

### 2 Play the keyboard.

You can call up panel settings (such as Voice and tempo) that match the selected Song or Style by using the One Touch Setting (OTS) function ([page 18](#)).

## SONG/STYLE

### 1 Press the [SONG]/[STYLE] button to select the desired mode.

Pressing this button will switch the mode. By default, **SONG** mode is selected.

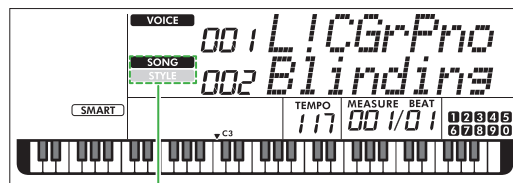

**SONG** The selected mode is shown.  
**STYLE**

### 2 Select the desired data.

The following three operations are available.

- Selecting from the SONG/STYLE category buttons
- Selecting via the [+]/[-] buttons
- Selecting via number input

For detailed instructions, see [pages 13 and 14](#).

### 3 Press [START/STOP].

Playback of Song or Style starts.

Press **[START/STOP]** again to stop playback.

## Selecting a Voice/Song/Style

The following three operations are available.

### Selecting from the Category buttons

#### Voice

Press any of the VOICE category buttons at the upper half of the front panel.

#### Song/Style

- 1 Select the desired mode by pressing [SONG]/[STYLE].
- 2 Press any of the SONG/STYLE category buttons at the lower half of the front panel.

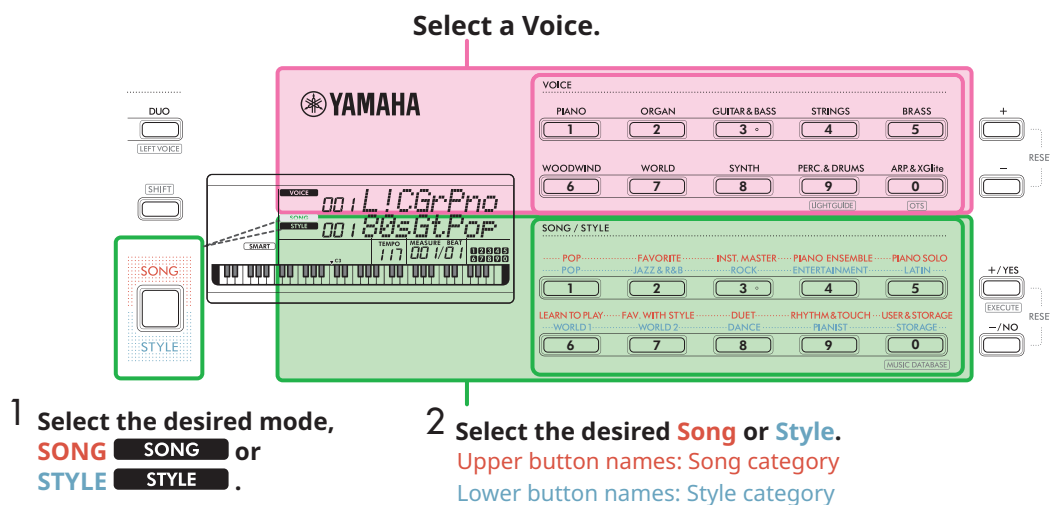

### Selecting via the [+]/[-] or [+YES]/[-/NO] buttons

#### Voice

Use the [+ ] or [- ] button.

#### Song/Style

- 1 Select the desired mode by pressing [SONG]/[STYLE].
- 2 Select the desired Song or Style by pressing [+ /YES] or [- /NO].

Press and hold either [+]/[-] or [+ /YES]/[- /NO] button to continuously increase or decrease the value in the corresponding direction. Pressing both [+]/[-] or [+ /YES]/[- /NO] buttons simultaneously returns the Voice and Style to No. 001 and returns the Song to No. 002.

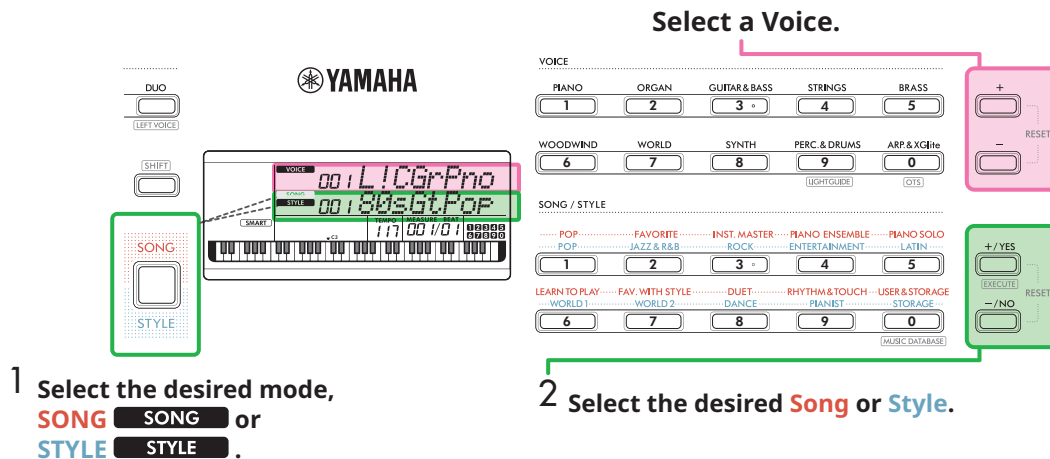

**Selecting via number input ( NUM LOCK )**

While **NUM LOCK** is shown in the display, number input is available.

If **NUM LOCK** is not shown in the display, simultaneously hold down **[SHIFT]** and press **[FUNCTION]**.

**Voice**

Select the desired Voice number by using the VOICE category buttons (as numeric buttons) at the upper half of the front panel.

**Song/Style**

- 1 Select the desired mode by pressing **[SONG]**/**[STYLE]**.
- 2 Select the desired **Song** or **Style** number by pressing the SONG/STYLE category buttons (as numeric buttons) at the lower half of the front panel.

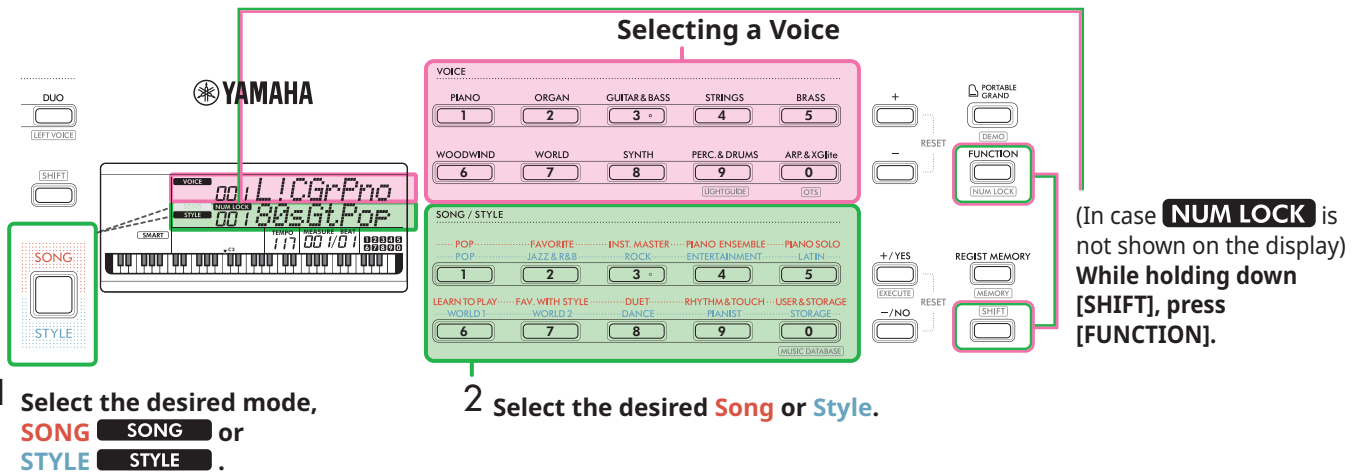

For details about Voice numbers and Song/Style numbers, refer to the Data List (page 2) on the website.

## Lighting Keyboard (Light Guide Function)

When using the Song Lesson function, the keys that you should press next will light in succession. These lit keys can help you play the keyboard easily, even if you have limited music reading skills. In addition to the Song Lesson, the keys that you press or those specified by Song data light.

### When you turn the Light Guide function on/off

The Light Guide function is turned on by default, but you can turn it off.

- 1 While holding down [SHIFT], press Voice Category [PERC.&DRUMS].

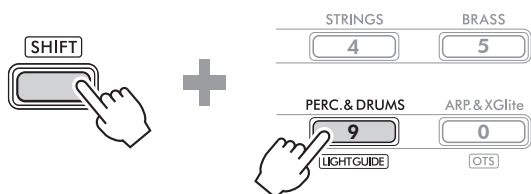

- 2 Press [+ / YES] or [- / NO] to turn off the Light Guide function.

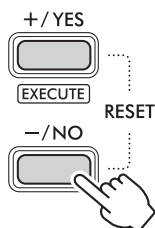

- 3 To exit the function settings, press [SHIFT].

#### NOTE

- Except for when playing yourself, the Keyboard lights only when the MIDI Song is played back. Note that Audio Song playback cannot light the keyboard.
- The MIDI Songs from the computer can light the keyboard by setting the MIDI channel as lighting target. For details, refer to "Right Part 1" (Function 042) and "Right Part 2" (Function 043) on page 64.

## Changing the Tempo

You can change the tempo of the Metronome (page 16), Style (page 30), and Song (page 38).

- 1 Press [TEMPO/TAP] to call up "Tempo" in the display.

The current tempo value appears.

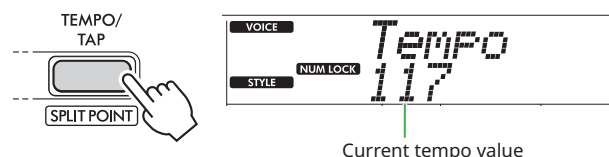

**NUM LOCK** appears via this operation. While this icon is shown, the SONG/STYLE category buttons can be used as numeric buttons.

- 2 Set the Tempo value by pressing the SONG/STYLE category buttons.

Setting range: 11-280

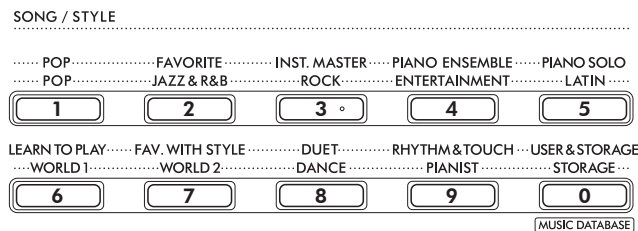

- 3 Press [SHIFT] to exit from the Tempo display.

### Using the Tap Tempo Function

During playback of a Style or Song, you can change the tempo by tapping [TEMPO/TAP] twice at the desired tempo. When Style and Song are stopped, tapping [TEMPO/TAP] (four times for a 4/4 time signature) starts playback of the rhythm part of the Style at the tempo you tapped.

Setting range: 32-280

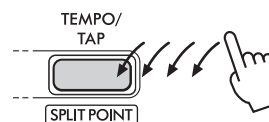

## Using the Metronome

The metronome can be used for effective practice.

- 1 Press [METRONOME] to start the metronome.



- 2 Press [METRONOME] again to stop the metronome.

## Adjusting the Metronome Volume

This can be adjusted in the Function Setting (page 63, Function 036).

Default setting: 100  
Setting range: 0-127

## Setting the Time Signature of the Metronome

This section describes how to set the Time Signature to 6/8 as an example.

- 1 While holding down [SHIFT], press [METRONOME].

The upper row of the display will show "TimeSigN" while the lower row will show the beat, or numerator of the Time Signature.

This operation switches the SONG/STYLE category buttons to numeric buttons.



While holding down...



Beat (numerator)

- 2 Set the desired Beat by pressing the SONG/STYLE category buttons.

If a number other than "0" is selected, the first beat is accented with a bell sound while all other beats play back a click sound. Here, select "6" as an example.

Setting range: 0-60

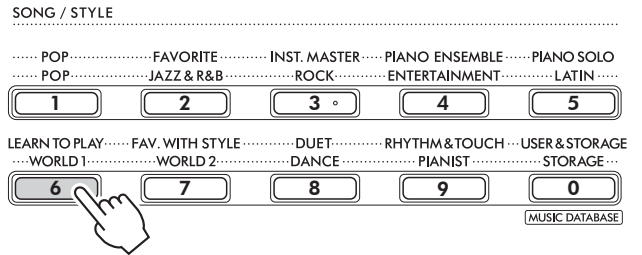

- 3 Press [+].

The upper row of the display will show "TimeSigD" while the lower row will show the note type that counts as one beat, or denominator of the Time Signature.

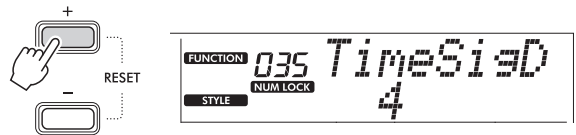

- 4 Select the note type from among "2," "4," "8," and "16" by pressing [+]/YES[/-]/NO.

Here, select "8" as example.

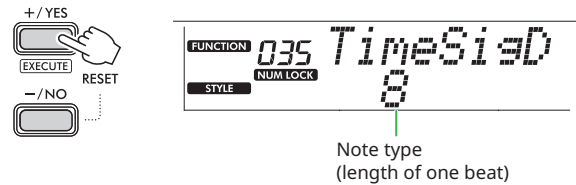

- 5 To exit from this display, press [SHIFT].

- 6 Play back the Metronome to check the setting.



# Display Items

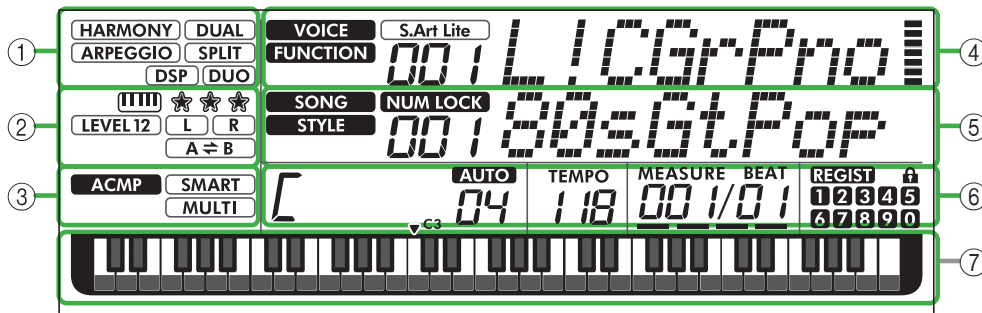

## ① Function status

Indicates the current on/off status of each function.

<b>HARMONY</b>	Harmony (page 23)
<b>ARPEGGIO</b>	Arpeggio (page 23)
<b>DSP</b>	DSP (page 26)
<b>DUAL</b>	Dual (page 19)
<b>SPLIT</b>	Split (page 20)
<b>DUO</b>	Duo (page 29)

## ② Song, Recording Part and Lesson-related indications

Indicates information about Lesson (page 43), Song (page 41), Recording Part (page 50).

<b>    </b>	Keys To Success (page 44)
★ ★ ★	Evaluation of the Keys To Success (page 45)
<b>LEVEL 12</b>	The Song level of left-hand part (page 40)
<b>L</b> <b>R</b>	Song Part/Recording Part information (pages 41, 50)
<b>A ⇌ B</b>	A-B repeat (page 41)

## ③ Style-related indications

<b>ACMP</b>	Appears when the Style (Auto Accompaniment) is turned on (page 32).
<b>SMART</b>	How to play a chord that matches Style playback (Fingering type, page 31)
<b>MULTI</b>	

## ④ Upper Main indications

Indicates the current Voice name and number. When any Function is being edited, this area indicates the current Function number and name.

The following information is indicated by each of the icons at the left of the Voice/Function name and the meter at the right of the Voice/Function name.

<b>VOICE</b>	The Voice name is shown on the display.
<b>FUNCTION</b>	The Function is being operated.
<b>S.Art Lite</b>	The S.Art Lite Voice (page 22) is currently selected.
<b>    </b>	The meter that lights up according to the strength (Touch Response, page 21) with which you play the keyboard.

## ⑤ Lower Main indications

Indicates the current Song/Style name and number. When any Function is being edited, this area indicates the current value. The following information is indicated by the icons at the left of the Song/Style or Function value.

<b>SONG</b>	The Song mode is selected.
<b>STYLE</b>	The Style mode is selected.
<b>NUM LOCK</b>	The numeric input is available (pages 14, 60).

## ⑥ Playback/Recording status and Function status

Indicates the status of playback/recording including the chord and tempo as well as the Function value.

<b>C</b>	Chord which is played on the Auto Accompaniment area (page 32) of the keyboard, or specified via Auto Chord Play (page 30) or Song playback (page 39).
<b>AUTO</b> <b>04</b>	<b>AUTO</b> : Appears when Auto Chord Play is turned on. <b>Number</b> : Repeatedly displays a countdown of the number of measures (chords) to be played.
<b>TEMPO</b> <b>118</b>	Tempo (page 15)
<b>MEASURE BEAT</b> <b>00 1/0 1</b>	<b>MEASURE</b> : Current measure number during playback <b>BEAT</b> : Current Beat during playback
<b>REGIST</b> <b>+</b> <b>1 2 3 4 5</b> <b>6 7 8 9 0</b>	Status of the Registration Memory (page 52) • Memory number containing data • Freeze on/off status

## ⑦ Keyboard indication

Indicates notes currently being played.

▼ C3 indicated around the center of the keyboard will mean the middle C of the piano.

### Returning to the Home Display ( **SHIFT** button)

The display with the Voice name on the upper row and the Song/Style name in the lower row is referred to the "Home display." Press **SHIFT** to return to the home display from displays other than the home display such as the Function setting display (page 60).

# Playing a Variety of Instrument Voices

In addition to piano, organ, and other “standard” keyboard instruments, this instrument has a large range of Voices that includes guitar, bass, strings, sax, trumpet, drums and percussion, and even sound effects—giving you a wide variety of musical sounds.

## Selecting a Main Voice

### 1 Press one of the buttons from among the VOICE category buttons.

Each time you press the button, it changes to a different Voice within the same category.

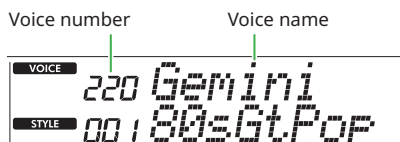
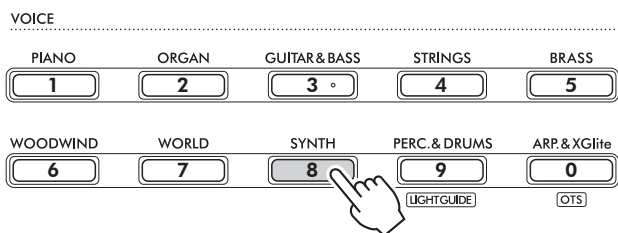

#### NOTE

- In addition to the above, two other operations are available for selecting the Voice. For details, see pages 13 and 14.

### Preset Voice Types

001–257	Voices of various instruments.
258–283 (Drum Kit)	Various drum and percussion sounds as well as sound effects are assigned to individual keys, from which they can be played. Details on the instruments and key assignments of each Drum Kit can be found in the Drum Kit List in the Data List (page 2) on the website.
284–303	Allows you to enjoy automatic arpeggio performance (page 23). Selecting any of these Voices will turn Arpeggio on automatically.
304–650	XGlite Voices. For details, refer to the Voice List in the Data List on the website.
000	<b>One Touch Setting (OTS)</b> Selecting this automatically calls up the most suitable Voice and panel setups for the current Style or Song. This function is called One Touch Setting (OTS). Select the Style or Song, and then select Voice number 000.

For details about Voice numbers or names, refer to the Data List (page 2) on the website.

### Play the keyboard.



### Playing with S.Art Lite Voices (Super Articulation Lite Voices)

Playing with the S.Art Lite Voice can reproduce playing techniques for particular instruments, such as guitar harmonics, by using [ARTICULATION]. For details, see page 22.

### Calling up the Grand Piano Voice

When you want to reset various settings to default and simply play a Piano sound, press [PORTABLE GRAND].



The Voice “001 Live!ConcertGrandPiano” will automatically be selected as the Main Voice.

## Layering another Voice over the entire keyboard (Dual)

In addition to the Main Voice, you can layer a different Voice over the entire keyboard as a “Dual Voice.”

### 1 Press [DUAL] to turn on the layer.

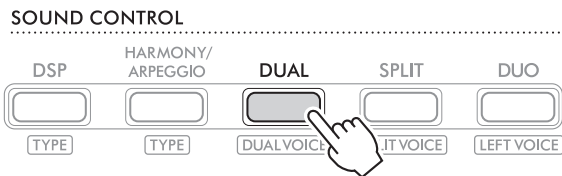

**DUAL** appears when Dual is on.

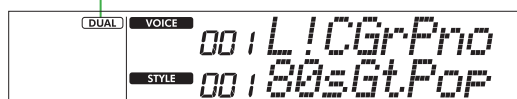

### 2 Play the keyboard.

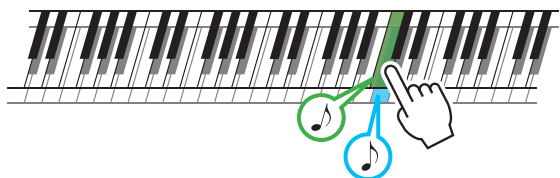

Two Voices will sound at the same time.

### 3 To exit from the layer, press [DUAL] again.

### To select a different Dual Voice:

While holding down [SHIFT], press [DUAL] to call up the display from which you can select your desired Voice. For information about how to select a Voice, see [page 18](#).

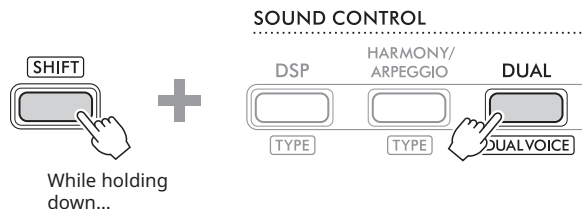

Press [SHIFT] to return to the Home display ([page 17](#)).

### Playing Different Voices with Your Left and Right Hands (Split)

By dividing the keyboard into the two separate areas, you can play one Voice with your left hand and a different Voice with your right hand.

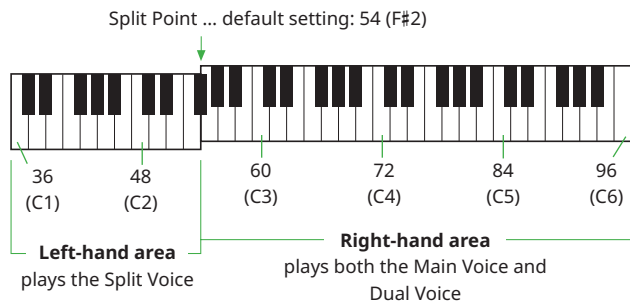

The right-hand area of the keyboard plays the Main Voice and Dual Voice while the left-hand area of the keyboard plays the Split Voice. The highest key for the left-hand area is referred to as the "Split Point" (page 60, Function number 003) which can be changed from the default F#2 key.

#### 1 Press [SPLIT] to turn on Split.

The keyboard is divided into the left-hand and right-hand areas.

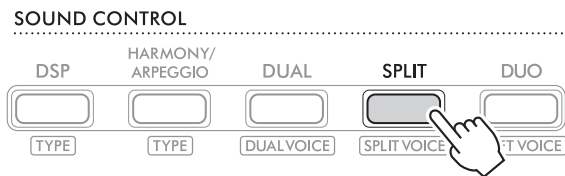

**SPLIT** appears when Split is on.

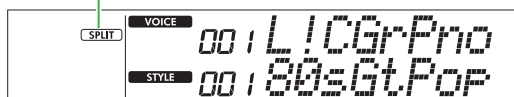

#### 2 Play the keyboard.

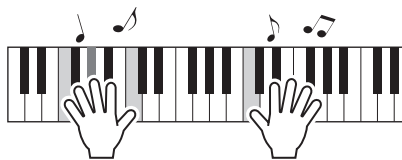

#### 3 To exit from the Split, press [SPLIT] again.

### To select a different Split Voice:

While holding down [SHIFT], press [SPLIT] to call up the display from which you can select your desired Voice. For information about how to select a Voice, see page 18.

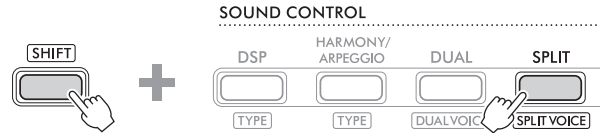

While holding down...



Press [SHIFT] to return to the Home display (page 17).

## Changing the Touch Response of the Keyboard

The keyboard of this instrument is equipped with a Touch Response feature that lets you dynamically and expressively control the level of the Voices according to your playing strength. Note that the weight (or resistance) of the keyboard itself is not affected.

- 1 Press [FUNCTION] to call up the Function display (page 60).



- 2 Press [+] / [-] until "TouchRes" (Function 004; page 60) is shown on the upper row of the display.

The current Touch Response is shown on the lower row of the display.

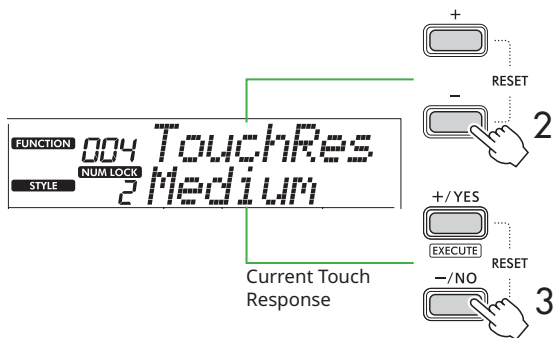

- 3 Use [+ / YES] and [- / NO] to select the desired Touch Response.

### Touch Response

1	Soft	Produces relatively high volume even with light playing strength. Best for players with a light touch who want to maintain a consistent, relatively loud volume.
2	Medium	Produces a fairly "standard" keyboard response (default setting).
3	Hard	The keys must be played very strongly to generate loud volume. This setting is best for a wide dynamic range and optimum expressive control of the sound, from pianissimo to fortissimo.
4	Off	All notes are produced at the same volume no matter how hard the keyboard is played.

- 4 Play the keyboard.

At the right corner of the upper row in the display, the meter will light according to your playing strength.

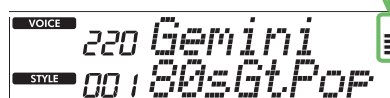
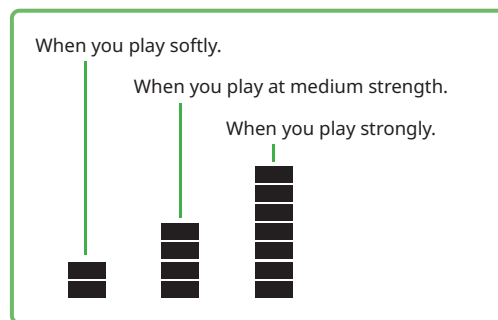

#### NOTE

- When the Touch Response is "Off", the meter is at fixed medium strength.

## Adding Articulation Effects

Articulation reproduces playing techniques for particular instruments, such as guitar harmonics. Articulation is added to your performance only while [ARTICULATION] is pressed. Voices to which Articulation can be added are called S.Art Lite (Super Articulation Lite) Voices.

### 1 Select the desired S.Art Lite Voice.

**S.Art Lite** appears in the display. You can confirm the S.Art Lite Voices by their "\*\*\*" indication in the Voice List in the Data List (page 2) on the website.

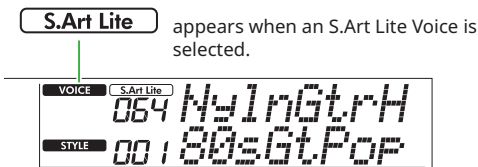

### 2 Try the effects by pressing [ARTICULATION] while playing the keyboard.



Release [ARTICULATION] to turn Articulation off.

## Examples of Articulation effects

If you select Guitar, you can use the following operations to realistically reproduce playing techniques that are unique to the guitar.

### Example: Voice Number 064 "S.Art Lite Nylon Guitar Harmonics"

While holding [ARTICULATION], play the keyboard to recreate guitar harmonics.

### Example: Voice Number 068 "S.Art Lite Distortion Guitar"

Press [ARTICULATION] to create a pick slide sound.

The Articulation effect is applied only when the S.Art Lite Voice is selected. When another Voice is selected, only a modulation is applied instead of Articulation effect.

## Using a Pedal to Add Articulation

If the Articulation function is applied to a pedal (footswitch) in the Function Settings (page 63, Function 033), you can conveniently step on the pedal to apply the effect as you play.

### NOTE

- The Articulation effect is applied only to the Main Voice.
- S.Art Lite Voices will produce different effects depending on the velocity.

## Adding Harmony or Arpeggio

You can add harmony notes or arpeggio playback to your keyboard performance. The Harmony Type (001–026) lets you add harmony (such as duet and trio), trill, tremolo or echo to the played note or notes of the Main Voice. The Arpeggio Type (027–178) lets you play Arpeggios (broken chords) simply by playing the notes on the keyboard.

### 1 Press [HARMONY/ARPEGGIO] to turn on the Harmony or Arpeggio function.

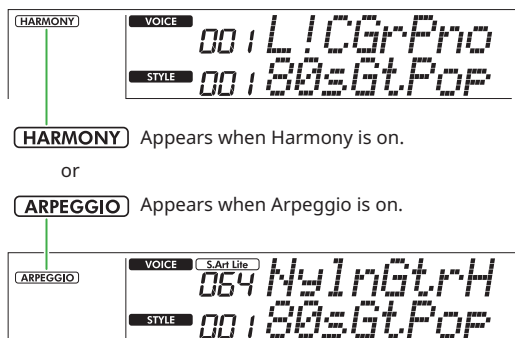
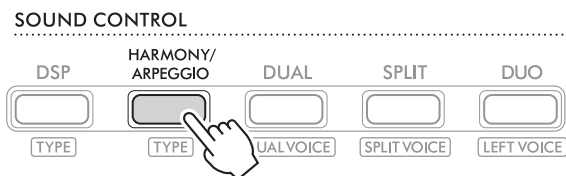

When Harmony or Arpeggio is turned on, the most suitable effect will be selected automatically for the current Main Voice. If you want to select another type, follow operation steps 2 and 3.

**NOTE**

- When selecting a Voice number between 284 and 303, the Arpeggio function will automatically be turned on.

### 2 While holding down [SHIFT], press [HARMONY/ARPEGGIO].

“Harm/Arp” appears at the upper row while the current Type appears on the lower row of the display.

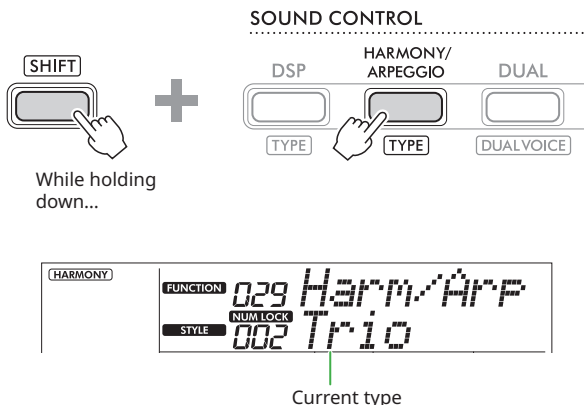

### 3 Use [+ / YES] / [- / NO] to select the desired Type.

This operation can be done by using the SONG/STYLE category buttons as numeric input buttons. For details about the Types, refer to the Data List (page 2) on the website.

**NOTE**

- When playing one of the Arpeggio Types 143 to 178, select the corresponding Voice below as the Main Voice.
  - 143–173: Drum Kit Voices (Voice No. 258–270)
  - 174 (Chinese): Chinese Kit (Voice No. 271)
  - 175 (Indian): Indian Kit 1 (Voice No. 275) or Indian Kit 2 (Voice No. 276)
  - 176 (Arabic): Arabic Kit (Voice No. 277)
  - 177 (Indonesia): Indonesian Kit 1 (Voice No. 272), Indonesian Kit 2 (Voice No. 273), or Indonesian Kit 3 (Voice No. 274)
  - 178 (African2) African Big Kit (Voice No. 278)

### 4 Play the keyboard.

When one of the Harmony Types 001–005 is selected, turn ACMP on (page 32) and play the melody in the right-hand area while playing the chord in the left-hand area of the keyboard. For more details, refer to page 24.

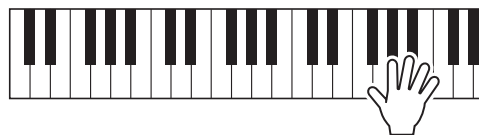

### 5 To turn Harmony or Arpeggio off, press [HARMONY/ARPEGGIO] again.

### How to play various Types

#### ● Harmony Types (001 to 026)

The method of playing the Harmony differs depending on the Type, as listed below.

- Harmony Type 001 to 005



Press the right-hand keys while playing chords in the Auto Accompaniment area of the keyboard when Auto Accompaniment is on (page 32).

- Harmony Type 006 to 012 (Trill)



Hold down two keys.

- Harmony Type 013 to 019 (Tremolo)



Keep holding down the keys.

- Harmony Type 020 to 026 (Echo)



Play the keys.

#### ● Arpeggio Types (027 to 178)

The Voice of Arpeggio playback is determined by the on/off status of the Split (page 20).

When Split is off:



Arpeggio function applies to the Main Voice and the Dual Voice.

When Split is on:



Arpeggio function applies only to the Split Voice.

#### NOTE

- Selecting a Voice number between 294 and 303 as the Main Voice will turn on both Arpeggio and Split automatically.

### To adjust the Harmony Volume:

This can be adjusted via Function 030 (page 62).

### To select how the Arpeggio Velocity is generated:

You can select whether to match the Arpeggio Velocity (strength) to your playing strength via Function 031 (page 62).



## Holding Arpeggio Playback via the Pedal (Footswitch)

You can set the instrument so that Arpeggio playback continues even after the note has been released, by pressing the pedal (footswitch) connected to the [SUSTAIN] jack.

- 1 Press [FUNCTION] to call up the Function display (page 60).



- 2 Press [+]/[-] until "PdIFunc" (Function 033; page 63) is shown on the upper row of the display.

The current function applied to the pedal is shown on the lower row of the display.

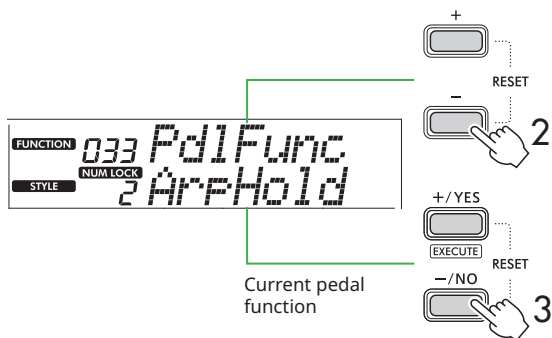

- 3 Select "ArpHold" by using [+ / YES] / [- / NO].

If you want to restore the pedal function to sustain, select "Sustain."

If you want to use both hold and sustain functions, select "Sus+ArpH."

- 4 Try playing Arpeggio by using the pedal.

Press two or more notes to trigger the Arpeggio playback, and then hold down the pedal. With this situation, Arpeggio playback will continue even if you release the notes.

To stop Arpeggio playback, release the footswitch.

## Synchronizing an Arpeggio to Song/Style Playback (Arpeggio Quantize)

When you want to play Arpeggio along with Song/Style, it may be difficult to press a note to start Arpeggio with accurate enough timing so that both of them are properly synchronized. To remedy this, you can enable automatic synchronization by setting Arpeggio Quantize (Function 032; page 62) to the optimum value by default for each Song or Style.

# Adding Effects to Performances and playback

## Adding DSP Effects

This instrument is equipped with various types of DSP (digital signal processor) effects, which allows various sound processing such as distortion or creating cavernous echo effects.

Although the most suitable type will be automatically selected for the current Main Voice, you can select another type via steps 2 and 3 below.

For details on DSP types, refer to the Data List (page 2) on the website.

### 1 Confirm that DSP is on.

If the **[DSP]** icon is not shown on the display, press **[DSP]**.

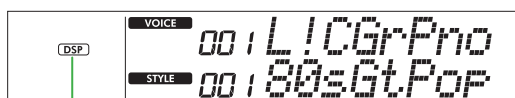
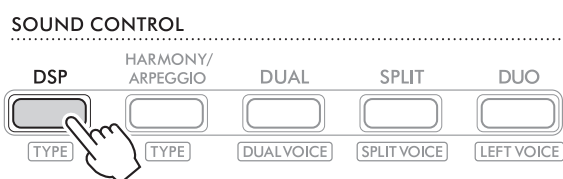

**[DSP]** appears when DSP is on.

For some Voices, DSP is automatically turned on just by selecting the Voice.

#### NOTE

- The DSP is applied only to the Main Voice. It is not applied to the Dual Voice (page 19) or Split Voice (page 20).
- The DSP cannot be turned on during Lessons.

### 2 While holding down **[SHIFT]**, press **[DSP]**.

On the display, the upper row shows "DSP Type" while the lower row shows the current DSP type.

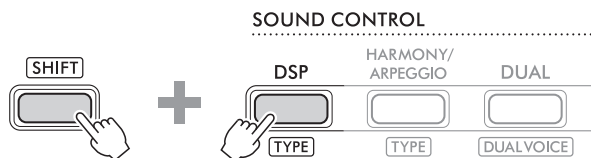

While holding down...



Current DSP type

### 3 Use **[+ / YES]** and **[- / NO]** to select the desired DSP type.

This operation can be done also via the SONG/STYLE category buttons.

### 4 Play the keyboard.

### 5 Press **[DSP]** again to turn off the DSP.

## Selecting a Reverb Type

The Reverb effect adds reverberation to the sounds, such as a rich concert hall ambience. Although selecting a Style or Song calls up the optimum Reverb type for the entire sound, you can select any Reverb type you desire manually.

- 1 Press [FUNCTION] to call up the Function display (page 60).



- 2 Press [+] / [-] until "Reverb" (Function 023; page 62) is shown on the upper row of the display.

The current Reverb type is shown on the lower row of the display.

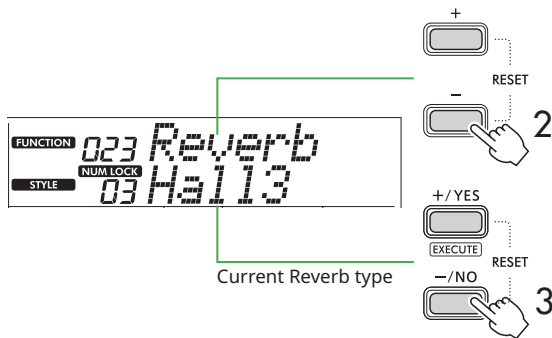

**NOTE**

- If a Reverb Type that is available only for Songs and Styles is used, "--" is shown on the display.

- 3 Use [+ / YES] / [- / NO] to select the desired Reverb type.

Audition the sound by playing the keyboard.

For detailed descriptions of the Reverb Types, refer to the Data List (page 2) on the website.

### Adjusting the Reverb depth

You can adjust the Reverb depth applied to the Main, Dual, and Split Voices individually via the same operations above. Regarding the item in step 2, refer to the Function List (page 61).

- 4 Press [SHIFT] to exit from the Function display.

## Selecting a Chorus Type

The Chorus effect creates a thick sound that sounds as if many of the same Voices are being played in unison. Although selecting a Style or Song calls up the optimum Chorus type for the entire sound, you can select any Chorus type you desire manually.

- 1 Press [FUNCTION] to call up the Function display (page 60).



- 2 Press [+] / [-] until "Chorus" (Function 025; page 62) is shown on the upper row of the display.

The current Chorus type is shown on the lower row of the display.

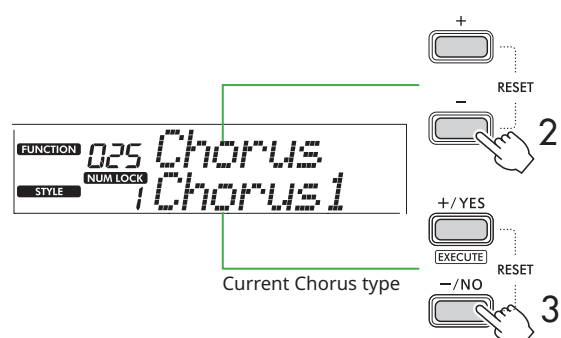

**NOTE**

- If a Chorus Type that is available only for Songs and Styles is used, "--" is shown on the display.

- 3 Use [+ / YES] / [- / NO] to select the desired Chorus type.

Audition the sound by playing the keyboard.

For detailed descriptions of the Chorus Types, refer to the Data List (page 2) on the website.

### Adjusting the Chorus depth

You can adjust the Chorus depth applied to the Main, Dual, and Split Voices individually via the same operations above. Regarding the item in step 2, refer to the Function List (page 61).

- 4 Press [SHIFT] to exit from the Function display.

## Selecting an EQ setting for your favorite sound

The Master EQ lets you adjust the sounds output from this instrument (to the main speakers of this instrument, as well as headphones, and external speakers) to your desired sound.

- 1 Press [FUNCTION] to call up the Function display (page 60).



- 2 Press [+] / [-] until "Master EQ" (Function 028; page 62) is shown on the upper row of the display.

The current Master EQ type is shown on the lower row of the display.

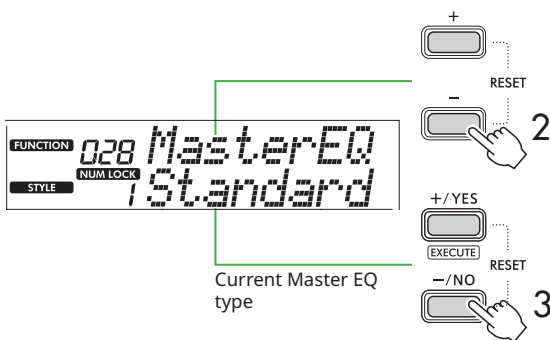

- 3 Use [+ / YES] / [- / NO] to select the desired Master EQ type.

### Master EQ types

1	Standard	Standard setting (Default)
2	Boost	Features more powerful sound. Depending on the selected Voice and Style, this type may make the sound more distorted than other EQ types.
3	Piano	Optimum for piano solo performance.
4	Bright	Lowers the mid range for a brighter sound.
5	Mild	Lowers the high range for a softer sound.

- 4 Press [SHIFT] to exit from the Function display.

## Adding Sustain

By turning on "Panel Sustain" (Function 027; page 62), you can apply a fixed and automatic Sustain to the keyboard Voices (Main/Dual Voices). You can also produce a natural sustain as desired with the footswitch (sold separately; page 54).

### NOTE

- The sustain function does not affect Split Voices (page 20) and Style (page 30).
- Even if you turn on Sustain, there are some Voices to which sustain is not applied.
- If this instrument is turned off while "Panel Sustain" is set to "On" in the Function setting display, the "On" status will be maintained even when the instrument is turned on the next time.

# Playing the keyboard with Two People (Duo)

When Duo is turned on, the keyboard is divided into left and right player sides, allowing two people to play in the same octave range at the same time. This is useful for learning situations, in which one person (a teacher, for example) plays a model performance and the other person watches and practices while sitting at the first person's side.

## 1 Press [DUO] to turn Duo on.

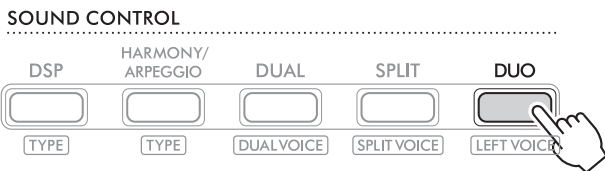

**DUO** appears when DUO is on.

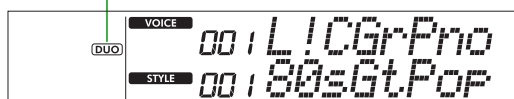

Duo Split Point...default setting: 66 (F#3)

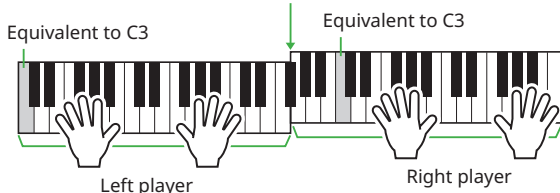

The keyboard is divided into left and right sections with the F#3 key as a boundary, and you can play the same range of notes on the left and right.

### NOTE

- The left and right player sides of the keyboard are both set to the same Voice.
- Duo Split Point can be changed from F#3 via Function 055 (page 65). When Duo is on, Function 055 can be called up via pressing [TEMPO/TAP] while holding down [SHIFT].

## 2 As necessary, change the Voice.

For information about how to select a Voice, see page 18.

### Changing only the Left Voice

Press [DUO] while holding down [SHIFT], and then select the desired Voice.

Press [SHIFT] to exit from the display for changing the left Voice.

### NOTE

- When the Right and Left Voices are different, only the Right Voice name is shown on the upper row on the display.
- While the Duo is on, you cannot use some functions such as Lesson, Harmony/Arpeggio, and Dual.

## 3 Play with two people, one on the left player side and one on the right player side.

## Speaker sound when Duo is on

The status of speaker playback during Duo can be changed via the Function display (page 60).

- 1) Press [FUNCTION] to call up the Function display.
- 2) Press [-] several times to call up "DuoType" (Function 060; page 65).
- 3) Press [+ / YES] / [- / NO] to select how the sound is output from the following two types.

### • Balance:

The sounds via the left player and right player will be output from both the speakers.

### • Separate (Default setting):

The sounds via the left player will be output from the left speaker, while the sounds via the right player will be output from the right speaker.

### NOTE

- If "DuoType" is set to "2 Separate," the sound of the Voice may differ compared to normal, such as with the pan, volume, and tonal characteristics of the stereo sound. Particularly with Drum Kits, the difference may be more obvious, since each key of a Drum Kit features a different stereo pan position.

## Sustain effect when Duo is on

Also, when Duo is on, you can apply a lingering decay (sustain effect) to the keyboard sound of both the right-side and left-side players via the following ways. For information about how to add Sustain to the Voice, see page 28.

### NOTE

- Sustain effects cannot be applied separately to the sound on the left and right player sides.

## Style Playback when Duo is on

Only the rhythm part of a Style can be played back. Other parts cannot be played back.

## Recording when Duo is on

The sounds played on both left and right player sides are recorded to the same part. When the ACMP (page 32) is turned on, as left player performance, melody is not recorded but information of chord change for Style is recorded.

## 4 To turn off Duo, press [DUO] again.

# Playing with Rhythm and Auto Accompaniment (Styles)

The Auto Accompaniment (ACMP) function plays Styles (rhythm + bass + chord accompaniment) that matches chords automatically. Use the Auto Chord Play function to hear the Styles first, and then play with Styles by specifying chords yourself.

There are two ways you can play the chords: "Smart Chord," which lets you play chords by simply playing one key, and "Multi Finger," which lets you play them conventionally, using all the constituent notes (page 31).

## Specify the Chords Automatically (Auto Chord Play)

Auto Chord Play enables you to hear and experience the chord progression without needing to specify the chords. The key to be played and chord name are displayed, so that you can learn chord progressions or play the melody part with the appropriate rhythms and accompaniment patterns.

- 1 Press [SONG]/[STYLE] to call up the **STYLE** icon and Style mode.



- 2 Press one of the SONG/STYLE category buttons to select the desired Style (page 13).

For details about Style numbers or names, refer to the Data List (page 2) on the website.

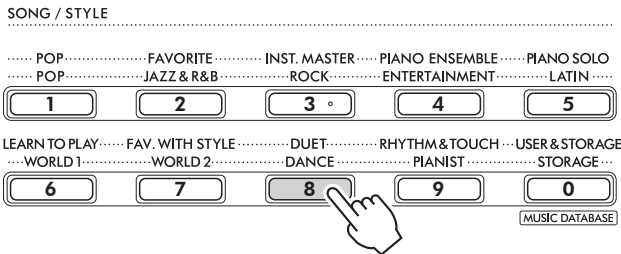

### NOTE

- In addition to the above, two other operations are available for selecting the Style. For details, see pages 13 and 14.

- 3 Press AUTO CHORD PLAY [ON/OFF] to turn on Auto Chord Play.



- 4 As necessary, select the desired chord progression.

Press AUTO CHORD PLAY [SELECT] to call up the Function setting display (Function 020; page 61), and then use [+ / YES] / [- / NO] to select the desired chord progression.

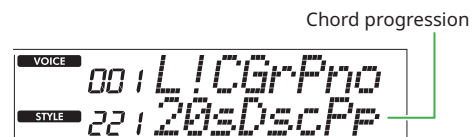
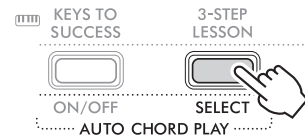

- 5 Press [START/STOP].

The chords progress automatically with the matching accompaniment patterns.

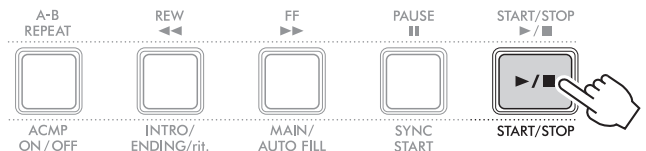

- 6 To stop the accompaniment pattern (Style playback), press [START/STOP] again.

### Style Tutorial Video

Make sure to watch this video and learn how to effectively use the Styles.



[https://yamaha.io/PSR-E383\\_TUT\\_ML\\_EN](https://yamaha.io/PSR-E383_TUT_ML_EN)

(Common URL for PSR-E383 & EZ-310)

## Setting the Fingering Type

The method you use to play chords when using the Styles is determined by "Fingering Type," for which two Types are available.

### ● Smart Chord (Default setting)

Lets you play the Style by playing only the root note of a chord. Before using this function, make sure to set the Style Key (Key signature).

### ● Multi Finger

Lets you play the Style by playing all notes of a chord. However, major, minor, seventh, and minor sevenths can also be easily played by pressing one to three keys.

For information about chords, refer to "How to play Chords for Style Playback" (page 35).

#### 1 Press [FINGERING TYPE].

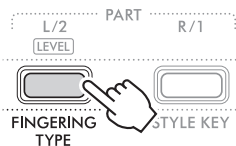

#### 2 Use [+ / YES] / [- / NO] to select "SmartChd" or "Multi."

#### 3 Press [SHIFT] to exit from the Fingering Type settings.

## Setting the Style Key

If the Fingering Type is set to "SmartChd," you need to set the Style Key (Key Signature) of the song before playing.

#### 1 Press [STYLE KEY].

The current Style Key appears.

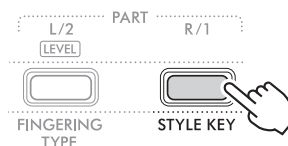

#### 2 Press [+ / YES] / [- / NO] to select the Style Key that matches the score.

For example, when you want to play the music score below, you need to set the Style Key to FL2 (2 flats) B<sup>b</sup>/G min (page 36).



#### 3 Press [SHIFT] to exit from the Style Key settings.

## Playing while Specifying the Chords

1 Press [SONG]/[STYLE] so that the **STYLE** icon appears.



2 Press one of the SONG/STYLE category buttons to select the desired Style (page 13).

For details about Style numbers or names, refer to the Data List (page 2) on the website.

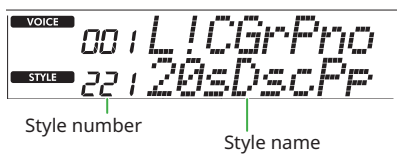
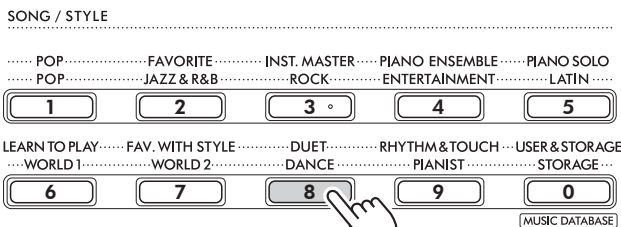

**NOTE**

- In addition to the above, two other operations are available for selecting the Style. For details, see pages 13 and 14.

3 Press [ACMP ON/OFF] to turn on Auto Accompaniment.

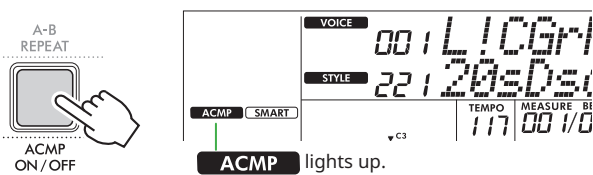

With this operation, the area of the keyboard to the left of the Split Point (54: F#2) becomes the "Auto Accompaniment area" and is used only for specifying the chords.

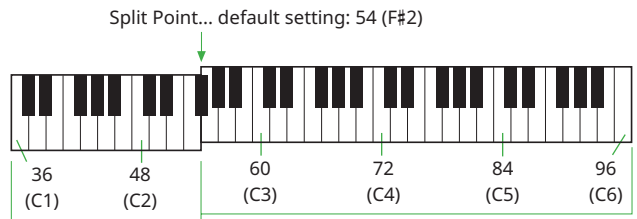

Auto Accompaniment area

The Split Point can be changed on the Function setting display (Function number 003; page 60) called up via by pressing [TEMPO/TAP] while holding down [SHIFT].

**NOTE**

- The strength meter (page 17) does not change even if playing in the Auto Accompaniment area.

4 Press [START/STOP] or [SYNC START].

- Press [START/STOP] to start playback only of the Rhythm part.
- Press [SYNC START] to call up the Synchro Start status in which you can start Style playback by pressing any note on the keyboard.

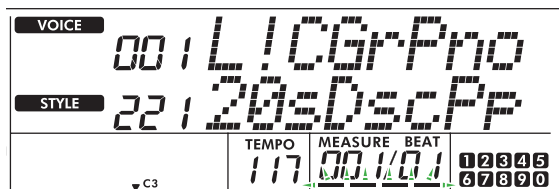
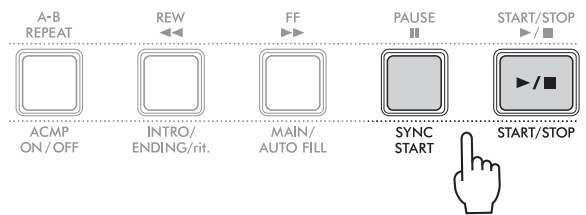

Flashes when Synchro Start is on.

5 Play a chord (root note) in the Auto Accompaniment area to start playback.

Play a melody with the right hand and chords with the left hand.

If the Fingering Type is set to "SmartChd," play only the root note of a chord with your left hand.

If the Fingering Type is "Multi," play all notes of a chord. For details about how to play a chord, see "How to play Chords for Style Playback" (page 35).

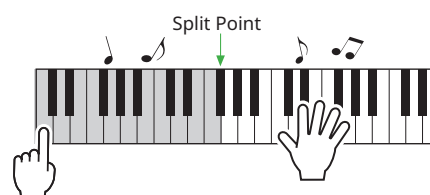



## 6 Press [START/STOP] to stop playback.

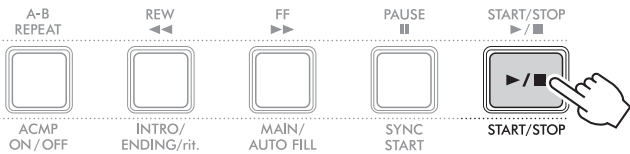

You can add intro, ending and rhythm variations to Style playback by using "Sections." For details, see the column at right.

### To play back the rhythm part only

If you press the [START/STOP] button (without pressing [ACMP ON/OFF] in step 3), only the rhythm part can be played back, and you can play a melody performance using the entire keyboard range.

#### NOTE

- Since the "Pianist" category Styles (Style No. 252–260) and "Ethereal Movie" (Style No. 090) have no rhythm parts, no sound will be produced if you start rhythm-only playback. These Styles can be played back by specifying a chord on the Auto Accompaniment area of the keyboard.

## Changing the Tempo

Refer to "Changing the Tempo" on [page 15](#).

## Adjusting the Style Volume

This operation lets you adjust the volume balance between Style playback and keyboard performance. This can be set via Function number 017 ([page 61](#)).

## Style Variations (Sections)

Each Style consists of "Sections" that allow you to vary the arrangement of the accompaniment to match the song you are playing.

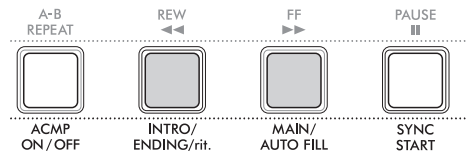

### ● INTRO

Used for the beginning of the song. When the Intro finishes, Style playback shifts to the Main section. The length of the Intro (in measures) differs depending on the Style.

### ● MAIN

Used for playing the main section of the song. Playback of the Main section repeats indefinitely until another Section's button is pressed. Two variations (A and B) are available.

### ● AUTO FILL

This is automatically added before changing to Main A or B.

### ● ENDING

Used for the ending of the song. When the Ending finishes, Style playback stops automatically. The length of the Ending (in measures) differs depending on the Style.

## 1 Press [SONG]/[STYLE] so that the **STYLE** icon appears.



## 2 Press one of the SONG/STYLE category buttons to select the desired Style ([page 13](#)).

For details about Style numbers or names, refer to the Data List ([page 2](#)) on the website.

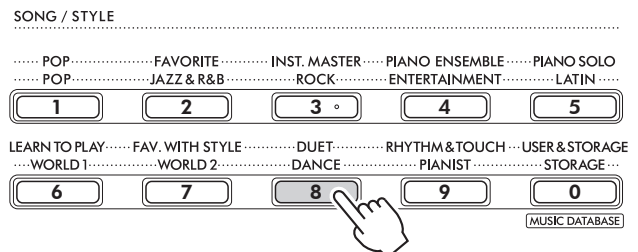

#### NOTE

- In addition to the above, two other operations are available for selecting the Style. For details, see [pages 13 and 14](#).

**3 Press [ACMP ON/OFF] to turn on Auto Accompaniment.**

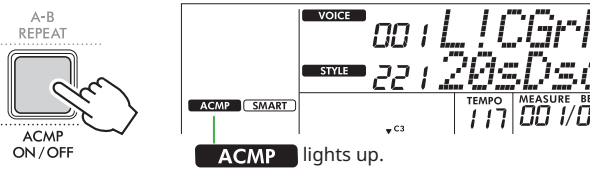

**4 Press [SYNC START] to turn Synchro Start on.**

This sets Style playback to standby, allowing you to start the Style simply by playing the keyboard.

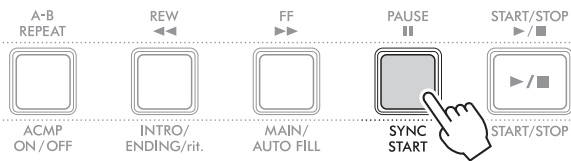

**5 Press [MAIN/AUTO FILL] to select Main A or Main B.**

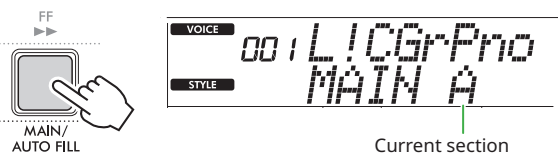

**6 Press [INTRO/ENDING/rit.].**

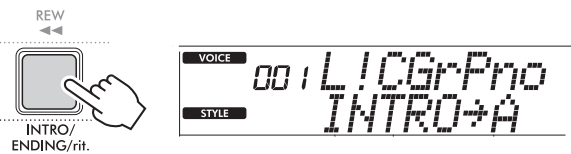

Now, you're ready to start Style playback from the Intro and then Main.

**7 Play a chord (root note) with your left hand to start playback of the Intro.**

For information on how to enter chords, refer to [page 35](#).

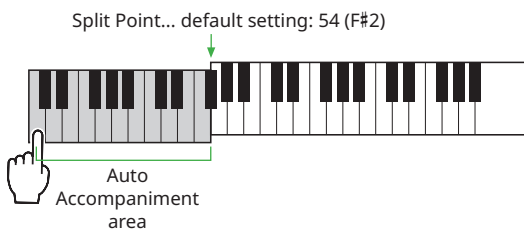

**8 After the Intro finishes, play the keyboard according to the song score.**

Play chords with your left hand while playing melodies with your right hand. As necessary, press [MAIN/AUTO FILL] to add a Fill-in, and then move to another Main Section (A or B).

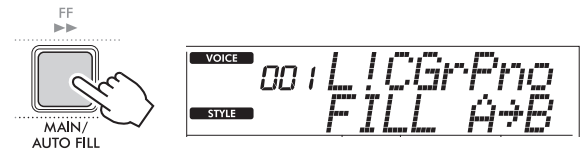

**9 Press [INTRO/ENDING/rit.].**



The Section switches to the Ending. When the Ending is finished, Style playback stops automatically.

You can have the Ending gradually slow down (ritardando) by pressing [INTRO/ENDING/rit.] again while the Ending is playing back.

## How to play Chords for Style Playback

For users who are new to chords, this chart conveniently shows how to play common chords in the Auto Accompaniment area of the keyboard.

Depending on the selected Fingering Type, the method for playing chords differs as follows.

- When the Fingering Type is “Multi,” play the notes that make up the chord as shown below.
- When the Fingering Type is “SmartChd,” play only the root note (marked with “★” in the chart below). The chord that is actually produced (such as major or minor) is automatically changed according to the current Style Key, simply by pressing only the root note.

★ Indicates the root note.

Major	Minor	Seventh	Minor Seventh	Major Seventh
<b>C</b> 	<b>Cm</b> 	<b>C7</b> 	<b>Cm7</b> 	<b>CM7</b> 
<b>D</b> 	<b>Dm</b> 	<b>D7</b> 	<b>Dm7</b> 	<b>DM7</b> 
<b>E</b> 	<b>Em</b> 	<b>E7</b> 	<b>Em7</b> 	<b>EM7</b> 
<b>F</b> 	<b>Fm</b> 	<b>F7</b> 	<b>Fm7</b> 	<b>FM7</b> 
<b>G</b> 	<b>Gm</b> 	<b>G7</b> 	<b>Gm7</b> 	<b>GM7</b> 
<b>A</b> 	<b>Am</b> 	<b>A7</b> 	<b>Am7</b> 	<b>AM7</b> 
<b>B</b> 	<b>Bm</b> 	<b>B7</b> 	<b>Bm7</b> 	<b>BM7</b> 

- Inversions can be used as well as in “root” position—with the following exceptions:  
m7, m7♭5, m7(11), 6, m6, sus4, aug, dim7, 7♭5, 6(9), sus2
- Inversions of 7sus4 chords are not recognized if the notes are omitted.
- When playing a chord which cannot be recognized by this instrument, nothing is shown on the display. In such a case, only a specific part, such as the rhythm, will be played.

When “Multi” is selected, major, minor, seventh, and minor sevenths can also be easily played by pressing one to three keys.

### Easy Chords for root “C”



**To play a major chord**  
Press the root note (★) of the chord.



**To play a minor chord**  
Press the root note together with the nearest black key to the left of it.



**To play a seventh chord (7)**  
Press the root note together with the nearest white key to the left of it.



**To play a minor seventh chord (m7)**  
Press the root note together with the nearest white and black keys to the left of it (three keys altogether).

## Chords Produced When Smart Chord is Selected

When the Fingering Type is “SmartChd,” if you set Style Key based on the composition of the score (page 31), play the root note in the Auto Accompaniment area. This produces the respective chords below.

Key Signature	Style Key (display)	Root Note											
		C#/D <sup>b</sup>		D#/E <sup>b</sup>		F#/G <sup>b</sup>		G#/A <sup>b</sup>		A#/B <sup>b</sup>			
		C	D	E	F	G	A	B					
 FL7 C <sup>b</sup> /A <sup>b</sup> min		Cdim	D <sup>b</sup> m	Ddim7	E <sup>b</sup> 1+5	E	Fdim	G <sup>b</sup> 7	G	A <sup>b</sup> m	A	B <sup>b</sup> m7 <sup>b</sup> 5	B
 FL6 G <sup>b</sup> /E <sup>b</sup> min		Cdim	D <sup>b</sup> 7	D	E <sup>b</sup> m	E	Fm7 <sup>b</sup> 5	G <sup>b</sup>	Gdim	A <sup>b</sup> m	Adim7	B <sup>b</sup> 1+5	B
 FL5 D <sup>b</sup> /B <sup>b</sup> min		Cm7 <sup>b</sup> 5	D <sup>b</sup>	Ddim	E <sup>b</sup> m	Edim7	F1+5	G <sup>b</sup>	Gdim	A <sup>b</sup> 7	A	B <sup>b</sup> m	B
 FL4 A <sup>b</sup> /F min		C1+5	D <sup>b</sup>	Ddim	E <sup>b</sup> 7	E	Fm	G <sup>b</sup>	Gm7 <sup>b</sup> 5	A <sup>b</sup>	Adim	B <sup>b</sup> m	Bdim7
 FL3 E <sup>b</sup> /C min		Cm	D <sup>b</sup>	Dm7 <sup>b</sup> 5	E <sup>b</sup>	Edim	Fm	F <sup>#</sup> dim7	G1+5	A <sup>b</sup>	Adim	B <sup>b</sup> 7	B
 FL2 B <sup>b</sup> /G min		Cm	C <sup>#</sup> dim7	D1+5	E <sup>b</sup>	Edim	F7	G <sup>b</sup>	Gm	A <sup>b</sup>	Am7 <sup>b</sup> 5	B <sup>b</sup>	Bdim
 FL1 F/D min		C7	D <sup>b</sup>	Dm	E <sup>b</sup>	Em7 <sup>b</sup> 5	F	F <sup>#</sup> dim	Gm	G <sup>#</sup> dim7	A1+5	B <sup>b</sup>	Bdim
No key signature 	SP0 C/A min (default)	C	C <sup>#</sup> dim	Dm	D <sup>#</sup> dim7	E1+5	F	F <sup>#</sup> dim	G7	A <sup>b</sup>	Am	B <sup>b</sup>	Bm7 <sup>b</sup> 5
 SP1 G/E min		C	C <sup>#</sup> dim	D7	E <sup>b</sup>	Em	F	F <sup>#</sup> m7 <sup>b</sup> 5	G	G <sup>#</sup> dim	Am	A <sup>#</sup> dim7	B1+5
 SP2 D/B min		C	C <sup>#</sup> m7 <sup>b</sup> 5	D	D <sup>#</sup> dim	Em	Fdim7	F <sup>#</sup> 1+5	G	G <sup>#</sup> dim	A7	B <sup>b</sup>	Bm
 SP3 A/F <sup>#</sup> min		Cdim7	C <sup>#</sup> 1+5	D	D <sup>#</sup> dim	E7	F	F <sup>#</sup> m	G	G <sup>#</sup> m7 <sup>b</sup> 5	A	A <sup>#</sup> dim	Bm
 SP4 E/C <sup>#</sup> min		C	C <sup>#</sup> m	D	D <sup>#</sup> m7 <sup>b</sup> 5	E	Fdim	F <sup>#</sup> m	Gdim7	G <sup>#</sup> 1+5	A	A <sup>#</sup> dim	B7
 SP5 B/G <sup>#</sup> min		Cdim	C <sup>#</sup> m	Ddim7	D <sup>#</sup> 1+5	E	Fdim	F <sup>#</sup> 7	G	G <sup>#</sup> m	A	A <sup>#</sup> m7 <sup>b</sup> 5	B
 SP6 F <sup>#</sup> /D <sup>#</sup> min		Cdim	C <sup>#</sup> 7	D	D <sup>#</sup> m	E	Fm7 <sup>b</sup> 5	F <sup>#</sup>	Gdim	G <sup>#</sup> m	Adim7	A <sup>#</sup> 1+5	B
 SP7 C <sup>#</sup> /A <sup>#</sup> min		Cm7 <sup>b</sup> 5	C <sup>#</sup>	Ddim	D <sup>#</sup> m	Edim7	F1+5	F <sup>#</sup>	Gdim	G <sup>#</sup> 7	A	A <sup>#</sup> m	B

**NOTE 1**

- The “1+5” chord indication on the instrument’s display is the same as that of a major chord.
- The chord names above are the same as shown on the instrument display. Some displayed notation may differ from that of commercially available sheet music.

## Using the Music Database

If you have difficulty finding and selecting a desired Style and Voice, use this feature. From the Music Database, just selecting your favorite music genre calls up the ideal settings.

### 1 While holding down [SHIFT], press [STORAGE].

The Music Database name appears on the display, and both Auto Accompaniment and Synchro Start are automatically turned on.

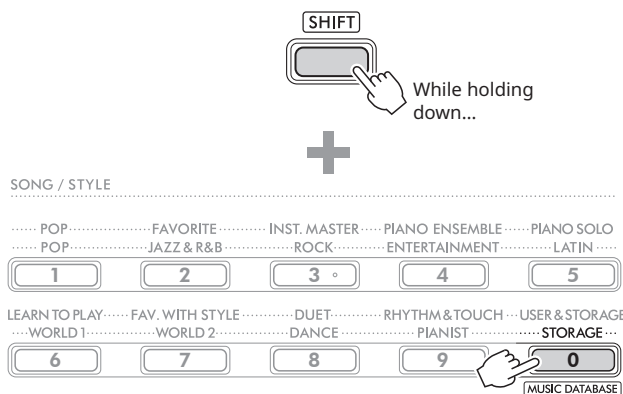

**NUM LOCK** While this icon is shown on the display, you can use the SONG/STYLE category buttons as numeric buttons.

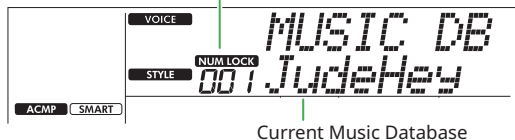

Current Music Database

### 2 Use [+ / YES] / [- / NO] or the SONG/STYLE category buttons (as numeric buttons) to select the desired Music Database.

The appropriate Voice and Style are automatically set. For information on the Music Databases that are available, see the Data List (page 2) on the website.

### 3 Play a key in the Auto Accompaniment area to start playback.

### 4 Press [START/STOP] to stop playback.

## Registering a Style File

Style data created on another instrument or computer can be registered (loaded) to Style numbers 261–270, and you can play them in the same way as the internal preset Styles. For details, see “Checking the files copied to the instrument” (page 58).

# Playing Back Songs

You can simply enjoy listening to the internal Songs, or use them with just about any of the functions, such as Lesson. When playing along with a preset Song, use the Touch Response ([page 60](#)) and Song Volume ([page 62](#)) functions to adjust the volume to suit your performance.

## ● Song Category

The Songs are organized by category as listed below.

Song number	Song category	Description
001	DEMO	Demonstrates various sounds that the instrument can produce.
002-013	POP	This category features a collection of hit songs. Have fun playing your favorite song.
014-050	FAVORITE	Various folk songs from around the world which have been handed down from through the generations, as well as famous classical pieces.
051-059	INSTRUMENT MASTER	Songs that features instruments other than the piano.
060-075	PIANO ENSEMBLE	Wonderful piano pieces not only for solo play but also for ensemble play.
076-093	PIANO SOLO	Well-known piano pieces.
094-109	LEARN TO PLAY	Songs which are used by the Keys To Success Lesson ( <a href="#">page 44</a> ). Each of the Songs consists of a Basic version and an Advanced version.
110-129	FAVORITE WITH STYLE	Songs that let you enjoy performing with Style as accompaniment ( <a href="#">page 32</a> ).
130-142	DUET	Songs that two people can enjoy playing together. These are arranged so that it is also possible to perform them alone.
143-152	RHYTHM & TOUCH TUTOR	Songs for practicing the timing and strength (touch) of playing each note of the keyboard.
153-	USER & STORAGE	Five User Songs (153-157) to which your keyboard performance is recorded and Songs (158-) which have been copied from a computer. The number of Songs that can be copied is determined by the amount of free space available on the instrument. For instructions about copying, refer to <a href="#">page 56</a> .

## Selecting and Playing Back a Song

- 1 Press [SONG]/[STYLE] to call up the **SONG** icon and Song mode.

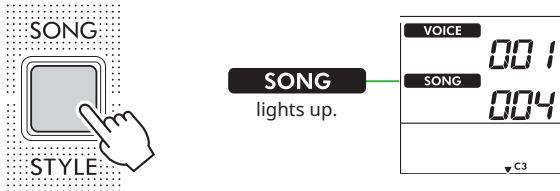

- 2 Press one of the SONG/STYLE category buttons to select the desired Song (page 13).

For details about Song numbers or names, refer to the Data List (page 2) on the website.

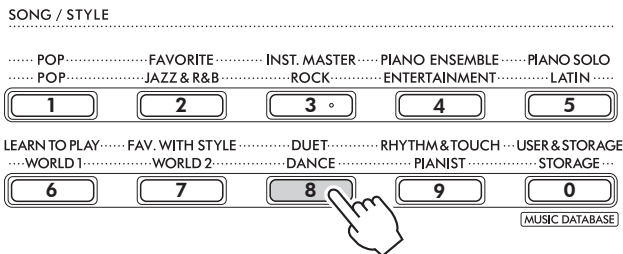

**NOTE**

- In addition to the above, two other operations are available for selecting the Song. For details, see pages 13 and 14.

- 3 Press [START/STOP] to start Song playback.

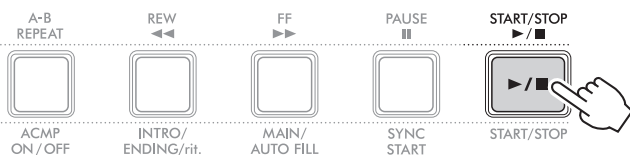

- 4 To stop playback, press [START/STOP] again.

## Changing the tempo

Refer to "Changing the Tempo" on page 15.

## Adjusting the Song Volume

This can be set via Function number 021 (page 62). This operation lets you adjust the volume balance between Song playback and the keyboard.

## Playing Back Songs in Sequence

While holding down [SHIFT], press [PORTABLE GRAND] to start playback of Songs continuously in sequence. Although only 13 Songs (Song No. 001-013) are played back continuously in sequence by default, this range can be changed.

- 1 Press [FUNCTION] to call up the Function display (page 60).



- 2 Press [+]/[-] until "DemoGrp" (Function 063; page 65) on the upper row of the display.

The current Demo Group is shown on the lower row of the display.

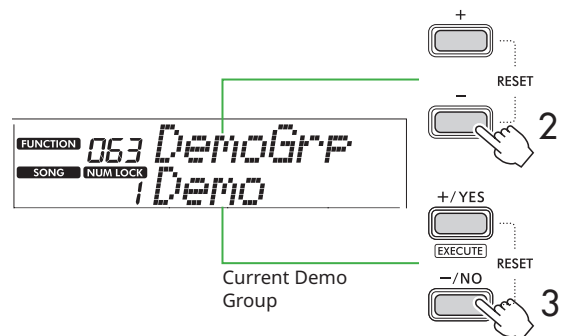

- 3 Use [+]/YES/[ -]/NO to select the desired Demo Group from the list below.

1	Demo	Preset Songs (001-013)
2	Preset	All preset Songs (001-142)
3	User	All User Songs (153-157)
4	Storage	All Songs copied from a computer (158-)

**NOTE**

- When either "User" or "Storage" is selected although they contain no data, Demo Songs are played back instead.

- 4 Press [PORTABLE GRAND] while holding down [SHIFT].

Songs contained in the selected group will be played back in sequence.

To stop playback, press [SHIFT] again or [START/STOP].

## Random Song Playback

When the Demo Group (above) is set to something other than "Demo," the playback sequence can be changed between numerical and random. To do this, press [FUNCTION] several times until "PlayMode" (Function 064; page 65) appears, then select "Normal" or "Random."

### Selecting the level of the left-hand part

Some of the preset Songs allow you to select from among two different levels for the left-hand performance. For information about such corresponding Songs, refer to the Song List in the Data List (page 2). When a corresponding Song is selected, that is to say, "LEVEL 1" or "LEVEL 2" is shown on the display, change the Level as desired by pressing [L/2] while holding down [SHIFT], before starting playback.

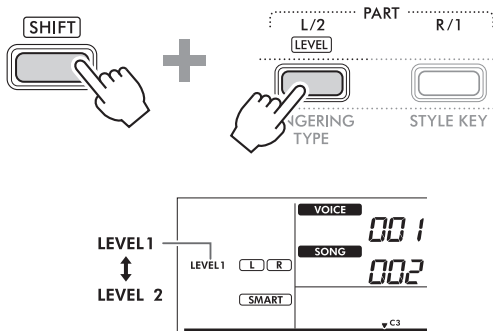

**NOTE**

- The selected Level will be maintained even if another Song is selected.

### Song Fast Forward, Fast Reverse, and Pause

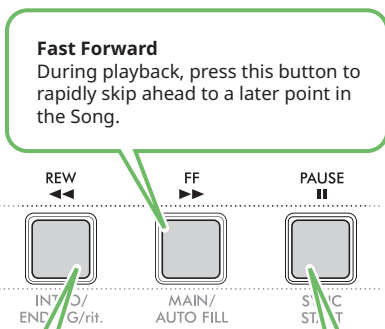

**Fast Reverse**  
During playback, press this button to rapidly return to an earlier point in the Song.

**Pause**  
During playback, press this button to pause playback, and press again to start from that point.

**NOTE**

- When the A-B Repeat function (page 41) is on, [REW] and [FF] will only work between A and B.
- [REW], [FF] and [PAUSE] cannot be used during continuous playback within the Demo Group (page 39).

### Changing the Song Melody Voice

You can change a Song's melody Voice to any other desired Voice.

- Select a Song.
- Select the desired Voice (page 18).
- Press [FUNCTION] to call up the Function display (page 60).

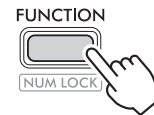

- Press [+] / [-] until "MelodyVc" (Function 022; page 62) appears on the upper row of the display. "YES?" appears on the display.



- Press [+ / YES].  
The message "SONG MELODY VOICE" is scrolled and displayed, and the Song's melody Voice changes to the Voice selected in step 2. After the Voice changes, the display returns to the Function display.

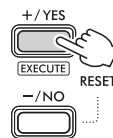

- Press [SHIFT] to exit from the Function display.
- Press [START/STOP] to listen to the Song with the changed Voice.

**NOTE**

- Selecting another Song will reset the Melody Voice setting.
- You cannot change the Melody Voice of a User Song and Songs in "RHYTHM & TOUCH TUTOR" category.



## A-B Repeat Playback

You can play back only a specific section of a Song repeatedly by setting the A point (start point) and B point (end point) in one-measure increments.

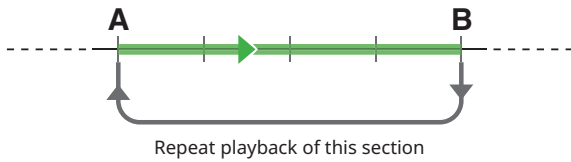

- 1 Start playback of the Song (page 39).
- 2 When playback reaches to the point you want to specify as the start point, press [A-B REPEAT] to set the A point.
- 3 When playback reaches to the point you want to specify as the end point, press [A-B REPEAT] again to set the B point.

The specified A-B section of the Song will now play repeatedly.

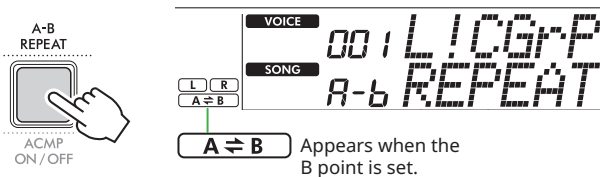

**NOTE**

- Even when the Song is stopped, A-B Repeat can be set by specifying each of A and B via [REW] and [FF].
- If you want to set the start point "A" at the top of the Song, press the [A-B REPEAT] button before starting playback.

- 4 To cancel repeat playback, press [A-B REPEAT].

**NOTE**

- Repeat playback can be canceled also by selecting another Song.

- 5 To stop playback, press [START/STOP].

## Turning Each Part of the Song On/Off

Song data consists of two Parts, which can be turned on or off individually by pressing the corresponding button only during playback.

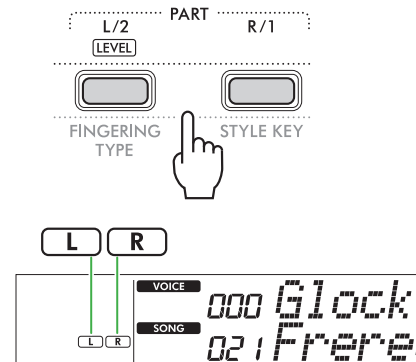

- When a User Song (Song numbers 153–157; page 49) is selected  
The "L" or "R" indications appear when the corresponding Part contains data, and are not shown when the corresponding Part is muted or contains no data.
- When Songs other than a User Song is selected  
The "L" or "R" indications appear regardless of whether the corresponding Part contains data or not.

By turning L and R on or off during playback, you can listen to the Part (that is turned on), or practice the other part (that is turned off) on the keyboard.

**NOTE**

- Selecting another Song will cancel the on/off status of the Parts.

## Copying Songs from a Computer to this Instrument

By using a USB cable to connect the [USB TO HOST] terminal of this instrument to a computer, you can load Song files from the computer. For details, refer to the "Copying the desired files from/to the computer" on page 56.

# Practicing the Timing and Touch of Playing the Keyboard (Rhythm & Touch Tutor)

This function is available when playing back Songs in the "RHYTHM & TOUCH TUTOR" category containing Songs 116-125.

- 1 Press [SONG]/[STYLE] so that the **SONG** icon appears.



- 2 Press [RHYTHM&TOUCH] in the SONG category buttons.

Make sure that Touch Response is set to a value other than "Off."

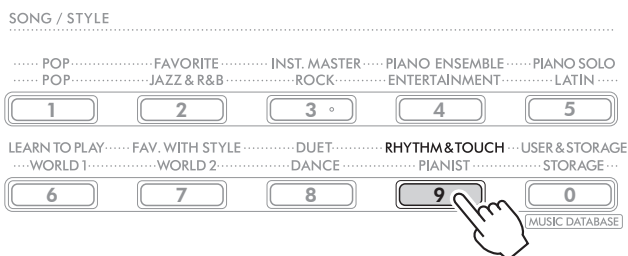

- 3 Press [START/STOP] to start Song playback.

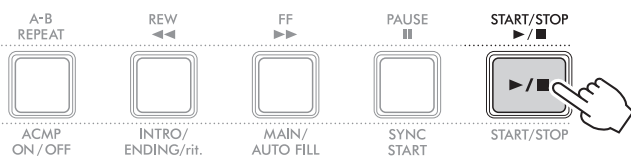

- 4 Press any note on the keyboard in accordance with the mark's movement.

As long as your timing and touch strength are correct, you can press any key.

The mark moves toward the right.

There are three marks of different sizes depending on the touch strength.

Play the keyboard at a strength appropriate to the size of the mark displayed.

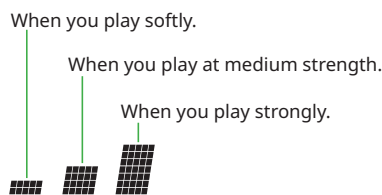

When the mark comes and overlaps here, play the keyboard while being aware of your playing strength.

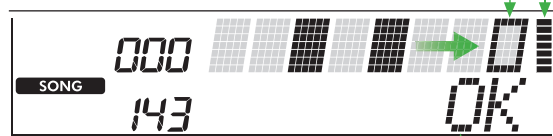

If only the timing is correct, "OK" appears; if both the timing and touch strength are correct, "Good!" appears.

To stop Song playback, press [START/STOP].

- 5 When the Song ends, the practice results will appear on the display as a score and a message.

Excellent Play!  
Good Timing!  
Try Again

# Using the Song Lesson Feature

Use these convenient features to practice the preset Songs and improve your playing skills. The lessons are arranged for optimum, enjoyable learning, so select the one suitable for you, and take your keyboard skills higher, step by step. You can refer to the music score in the Song Book (free downloadable scores). For information about how to obtain the Song Book, see [page 2](#).

## Keys To Success

([page 44](#))

You can select just the key phrases of the Song—the ones you like most or need to work on—and practice them one by one. This lesson is ideal for beginning players.

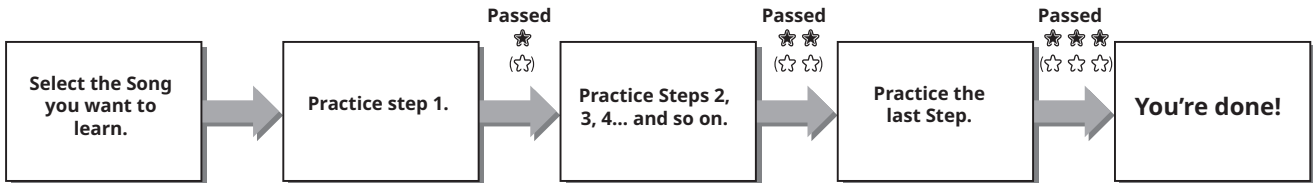

Each Song consists of several Steps. Each time you play all the way through the current Step, your performance will be evaluated. A score of "60" or more indicates that you passed this Step and you should try the next Step, which begins automatically.

The passing status ★ (When selected "Level 1" as the left-hand part level, "(?)" will be displayed.) is saved, but you can go on to the next Step even when you didn't pass the Step, or you can retry the Step later.

## 3-Step Lesson (Listen, Timing, and Waiting)

([page 47](#))

You can practice the preset Songs in three steps, independently for the right or left hand, or both hands together. This is ideal when you want to practice all the way through the Song with the selected part.

- Lesson 1 (Listen) ..... Listen to the playback part you will play. Remember it as best as you can.
- Lesson 2 (Timing) ..... Learn to play the notes with the correct timing. Even if you play wrong notes, the correct notes will sound.
- Lesson 3 (Waiting) ..... Learn to play the correct notes. The Song pauses until you play the right note.

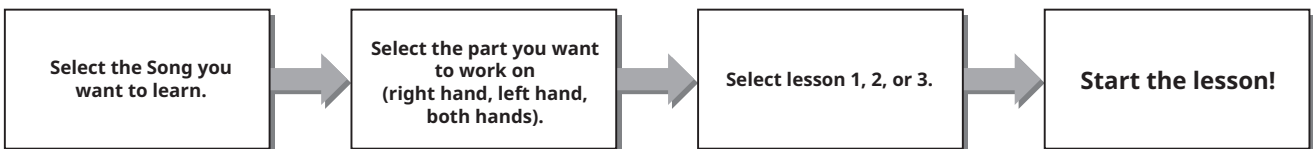

The 3-Step Lesson can be used together with Keys to Success ([page 44](#)).

If you feel it difficult to play the specific phrase in the Keys To Success lesson, use the 3-Step Lesson that lets you listen to the phrase, to practice only the timing to play, or to let the phrase pause until you play the correct notes.

The passing status is not shown when using the 3-Step Lesson together with Keys to Success.

## Keys To Success

This lesson lets you practice individual phrases in the Song (with each Step) to effectively master the entire Song.

### 1 Download the Song Book from Yamaha website (page 2).

The amount of Steps and lesson parts (which are pre-programmed) will differ depending on the Song. For details, refer to the Song Book.

**NOTE**

- All preset Songs 002 to 142 can be used with this mode, especially the "LEARN TO PLAY" category Songs.

### 2 Press [SONG]/[STYLE] so that **SONG** icon appears.



### 3 Press the SONG category buttons to select the desired Song.

Here, select the Song "Für Elise (Basic)" (Song No. 094) from the "LEARN TO PLAY" category, and then open the corresponding page of the Song Book.

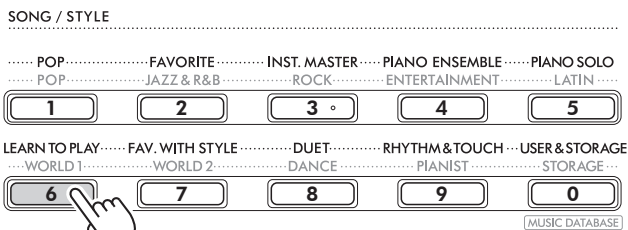

### 4 Press [KEYS TO SUCCESS] to engage this lesson.

The keyboard icon, "Step01" and lesson part ("R" or "L" or "LR") appears on the display. If you have already passed several Steps, the next Step number appears on the display.

Instead of the Step shown on the display, you can also select and practice another step. For details on how to select, refer to "Selecting and practicing a specific Step" (page 45).

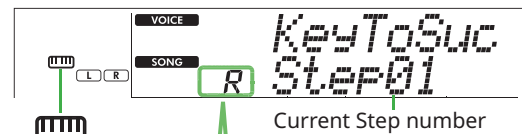

Appears when Keys To Success is on.

- Lesson part
- R : Right-hand lesson
  - L : Left-hand lesson
  - LR : Both-hands lesson

### 5 Press [START/STOP] to start Lesson.

After the lead-in (counting sound), playback of the current Step starts.

Try playing the keyboard while looking at the score in the Song Book or the note indication shown on the display.

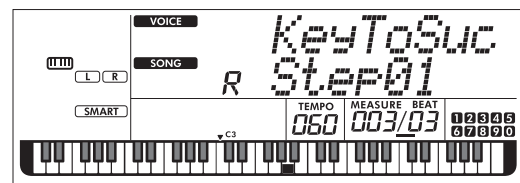
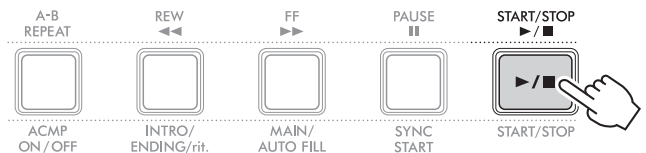

**NOTE**

- For your practice enjoyment, a special arrangement is applied to each Song. This is why playback tempo may be slower than original.

## 6 Confirm the evaluation in the current Step.

When the current Step reaches the end, your performance will be evaluated and your score (from 0–100) is shown in the display.

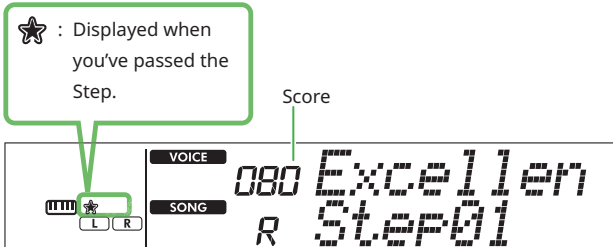

A score of “60”–“100” indicates that you passed this Step and you should try the next Step, which begins automatically. A score between “0”–“59” indicates that you did not pass this Step and you should try the same Step again, which begins automatically.

### NOTE

- If the practice part is set for both hands, you cannot pass the Step even if you play only one hand well. Only a message like “Left Part is correct!” appears in the display.

## 7 Perform Steps 02, 03, 04, and so on.

Every Song features a final Step in which you will play throughout the entire Song. When you pass all Steps, the Keys To Success mode will automatically be turned off and playback stops.

### Selecting and practicing a specific Step

If you want to practice a step you failed or repeat a step you are weak at, press [+YES]/[-NO] to select the desired step.

To cancel this Lesson, press [START/STOP].

## 8 To stop this Lesson, press [KEYS TO SUCCESS] again.

## Confirming your Passing Status

The ★ or ☆ on the display indicates whether the current Step or Song has been passed or not.

### ● When Step is selected

When a Song containing two levels is selected, ☆ indicates that the current Step of Level 1 has been passed while ★ indicates that the current Step of Level 2 has been passed.

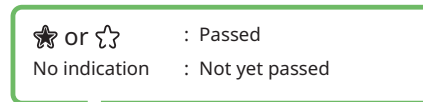

### ● When Song is selected

The amount of the stars indicates the passing status.

#### • Example indications of the passing status of level 2

- No indication : No Steps have been passed.
- ★ : One or more Steps have not been passed in addition to the last Step.
- ★ ★ : Only the last Step has been passed.
- ★ ★ ★ : All Steps except for the last Step has been passed.
- ★ ★ ★ ★ : All Steps have been passed.



#### • Example indications of a Song containing two levels

When a Level has been passed, ☆ is shown on the display. When only Level 2 has been passed, Level 1 is regarded as passed and only ★ is shown on the display.

★ ☆	: For Level 1, all Steps except for the last Step have been passed. For Level 2, one or more Steps except for the last Step have been passed.
★ ☆ ☆	: For Level 1, all Steps have been passed. For Level 2, one or more Steps except for the last Step have been passed.
★ ☆ ★	: For Level 1, all Steps have been passed. For Level 2, only the last Step has been passed.
★ ★ ☆	: For Level 1, all Steps have been passed. For Level 2, all Steps except for the last Step have been passed.
★ ☆	: For Level 1, only the last Step has been passed. For Level 2, any one of the Steps except for the last one has been passed.

## Clearing the Passing Status

All the records of passing results can be cleared.

● **To clear the passing status entries of all Steps:**

- 1 With **Keys To Success** off, select the **Song** for which you want to clear the passing results.
- 2 While holding down **[SHIFT]**, press **[KEYS TO SUCCESS]**.  
The confirmation message appears.

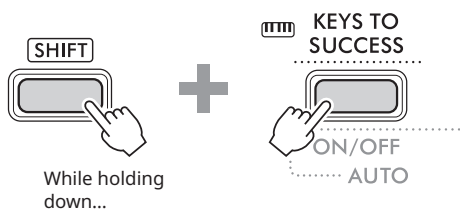

- 3 Press **[+ / YES]**.  
"Cleared" appears on the display, indicating that Clear is completed.

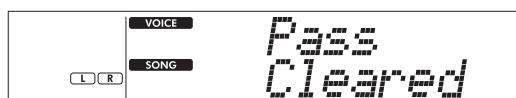
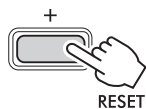

● **To clear the passing status entry for a specific Step:**

- 1 With **Keys To Success** off, select the **Song** for which you want to clear the passing results.
- 2 Press **[KEYS TO SUCCESS]** to turn it on.
- 3 Use **[+ / YES]** / **[- / NO]** to select the **Step** for which you want to clear the passing results.
- 4 While holding down **[SHIFT]**, press **[KEYS TO SUCCESS]**.  
The confirmation message appears.
- 5 Press **[+ / YES]**.  
"Cleared" appears on the display, indicating that Clear is completed.

## 3-Step Lesson (Listen, Timing, and Waiting)

### ● Lesson 1—Listen

In this Lesson, you need not play the keyboard. The model melody/chords of the part you selected will sound. Listen to it carefully and remember it well.

### ● Lesson 2—Timing

In this Lesson, simply concentrate on playing the notes with the correct timing. Even if you play wrong notes, the correct notes shown in the display will sound.

### ● Lesson 3—Waiting

In this Lesson, try playing the correct notes shown on the display. The Song pauses until you play the correct note, and playback tempo will change to match the speed at which you are playing.

#### NOTE

- If you want to keep a steady playback tempo maintained during Lesson 3: Waiting, set the Your Tempo parameter to Off via the Function number 039 (page 63).

### 1 Press [SONG]/[STYLE] so that the **SONG** icon appears.



### 2 Press the SONG category buttons to select the desired Song (page 13).

#### NOTE

- The 3-Step Lesson can be applied also to Songs copied from a computer (page 56), but cannot be applied to User Songs (page 49) or Demo Song (page 38).

### 3 Press either or both [R/1] and [L/2] to select the Part you want to practice.

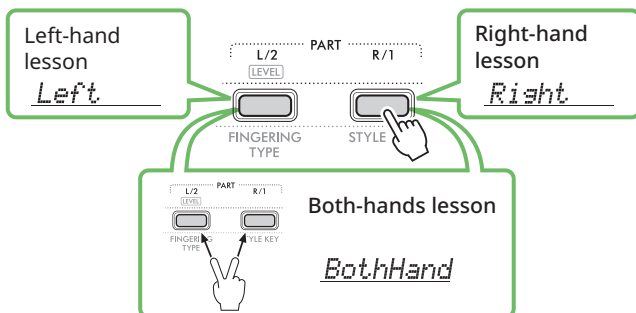

#### NOTE

- When "No LPart" appears by pressing [L/2], the current Song does not contain a left-hand part.

### 4 Press [3-STEP LESSON] to start playback of the Song Lesson.

Pressing this button repeatedly will change the Lesson number from 1: LISTEN, 2:TIMING, 3:WAITING, off, and back again. Press this button until the desired number is shown on the display.

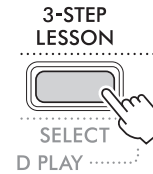

#### NOTE

- During Lesson playback, you can change the Lesson number by pressing this button, and you can stop the Lesson at any time by pressing [START/STOP].
- During Lesson playback, the Main Voice changes to "000" (One Touch Setting; page 18) automatically, and the Dual Voice and Split Voice cannot be used.
- When the Song Melody Voice is changed (page 40), the note indication on the display may be shifted by an octave depending on the selected Voice.

### 5 When Lesson playback reaches to the end, check your evaluation Grade on the display.

"2 Timing" and "3 Waiting" will evaluate your performance in four levels.

Excellent! ██████████  
 Very Good! ████████  
 Good ██████  
 OK ████

After the evaluation has appeared, the Lesson will start again from the beginning.

### 6 To stop Lesson, press [START/STOP].

## Turning the Guide note off

When the Guide function is on, you can hear the Guide note while you are practicing with Lesson 3 (Waiting), making it ideal when you are not sure of which keys to play next. The Guide note will sound slightly behind the timing to indicate the correct note when you fail to play the correct note with the correct timing. When you play the correct note with the correct timing, the Guide note will not sound and playback continues. If you don't want to hear the Guide note, turn the function off with the following steps.

- 1 Press [FUNCTION] to call up the Function display (page 60).
- 2 Press [+] / [-] until "Guide" (Function 040; page 63) appears on the upper row of the display.

The lower row of the display will show the current Guide setting.

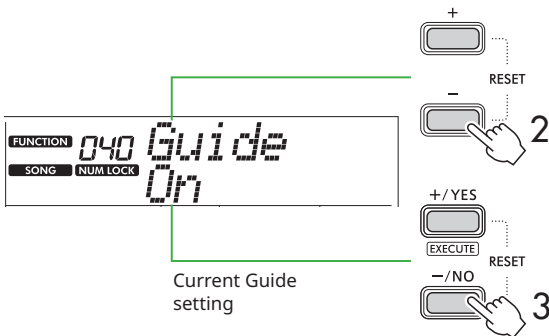

- 3 Press [-/NO] to select "Off."

The default value of this function is "On" (Guide note will sound).

**NOTE**

- This operation is not available during the Lesson mode.
- This operation disables the keys to light.

The Guide note function is available for all preset Songs, except Songs in categories "FAVORITE WITH STYLE" (left-hand part) and No. 59.

## Keys To Success with 3-Step Lesson

Both the Lessons can be combined together.

- 1 **Enable the Keys To Success lesson.**  
Refer to Steps 2–4 on page 44.
- 2 **Select the desired Step via [+ / YES] / [- / NO], then press [3-STEP LESSON] several times to select the desired lesson.**  
The selected Lesson playback starts under the Keys To Success mode. Practice the phrase of the current Step via the selected Lesson. As evaluation for each Step, just "Timing is correct!" or "Your playing is correct!" appears, and the passing status is not available.
- 3 **To return to only the Keys to Success mode, press [3-STEP LESSON] several times until "StepXX" (XX: number) appears in the display.**
- 4 **To exit from the Lesson mode, press [KEYS TO SUCCESS].**



# Recording Your Performance

You can record up to five of your performances as User Songs (User 1–5: Song numbers 153–157). The recorded User Songs can be played back on the instrument. The recorded User Song can be played back in the same way as the preset Songs.

## Recording a New User Song

This section covers how to record your performance to a new User Song, which will be saved to this instrument. You can record up to five of your performances as User Songs (User 1–5: Song numbers 153–157).

- 1 Press [SONG]/[STYLE] so that **SONG** icon appears.



- 2 Make the desired settings for Voice and Style.  
If you want to record Style playback, turn ACMP on (page 32).

- 3 Press [REC] to enter the Record Ready mode.  
This operation selects the lowest-numbered unrecorded User Song (153–157 or "User 1"–"User 5") as the recording and saving destination. If you want to record to another specific User Song, use [+ / YES] and [- / NO] before pressing [REC].

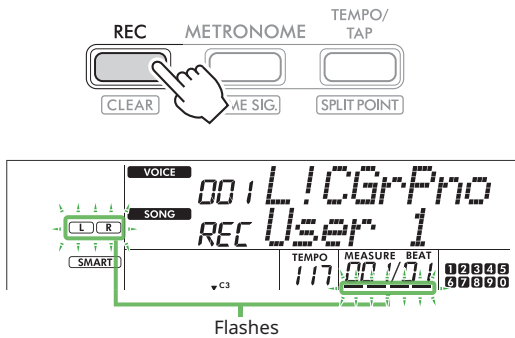

To exit from the Record mode, press [REC] again to stop the flashing display.

- NOTICE**
- If all User Songs contain recorded data, "User 1 (Song number 153)" will automatically be selected. In this case, since you will record over and erase any previous data in "User 1," we recommend that you save your important data to a computer (see page 56).

- NOTE**
- Auto Accompaniment cannot be turned on/off in recording standby.

- 4 Play the keyboard to start recording.  
You can independently record just the rhythm sound of Style playback by pressing [START/STOP], and then changing the Section (page 33).

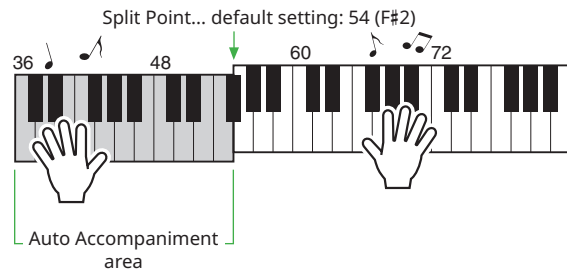

- 5 Press [START/STOP] to stop recording.  
When using a Style, you can stop recording also by pressing [INTRO/ENDING/rit.], and then waiting until playback ends.  
As soon as recording ends, "Writing!" appears, and then the corresponding data is saved.

- NOTICE**
- While "Writing!" is shown on the display, never turn the power off or connect/disconnect the AC adaptor. Doing so can result in loss of data.

- 6 To play back the recorded Song, press [START/STOP].

### Limitations while Recording

- You cannot record the Reverb Level, metronome click, or the Transpose and Tuning settings.
- The following settings and buttons are not available, or if operated, the new settings cannot be recorded:  
ACMP ON/OFF, Split Point, Reverb Type, Chorus Type, Harmony/Arpeggio Type, [FUNCTION] button, [PORTABLE GRAND] button.

## Recording to a Specified Part (Track)

### Part (Track) Structure of a Song

You can record your performance to the following two Parts (Tracks) of a User Song individually or simultaneously.

● **Part R/1:**

Your melody performance is recorded to this Part.

● **Part L/2:**

Style playback (Chord changes and Section changes) is recorded to this Part.

To specify the recording Part for the target, use [R/1] and [L/2]. "1" and "2" engraved on the button indicates the Part number.

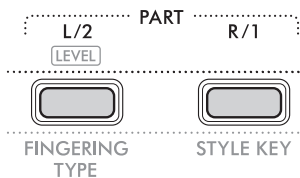

**1 Make the desired settings for Voice and Style.**

If you want to record Style playback, turn ACMP on (page 32).

**2 While holding down [REC], press [R/1] or [L/2] to engage the Record mode.**

If you want to record Style playback, make sure to select Part 2. If you want to record a melody performance, select either Part 1 or Part 2 as desired.

You can record the DSP effect only to Part 1.

The example illustration below shows selecting Part 2.

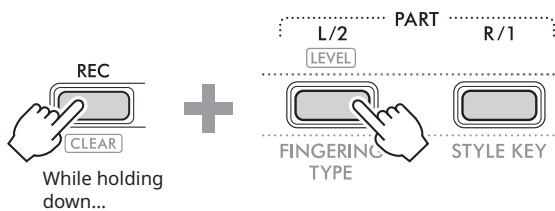

The User Song appears on the display.



"R" indicates Part 1 while "L" indicates Part 2. Both the icons flash, stay on, or turn off depending on the status of data and operation.

- Flashing : Selected as Recording target.
- On : Contains the recorded data.
- Off : Contains no data, or is muted.

While recording, the already recorded Part can be played back or muted.

To play back or mute, press [R/1] or [L/2]. Pressing them switches the playback/mute status.

**3 Press [+ / YES] [- / NO] to select the desired User Song.**

If "R" or "L" appears on the display, the selected Song is already recorded.

**4 Play the keyboard to start recording.**

If any part has already been recorded, you can record another part while playing back the previously recorded part by pressing [START/STOP].

You can independently record just the rhythm sound of Style playback by pressing [START/STOP], and then changing the Section (page 33).

**5 Press [START/STOP] to stop recording.**

As soon as recording ends, "Writing!" appears, and then the corresponding data is saved.

**NOTICE**

- While "Writing!" is shown on the display, never turn the power off or connect/disconnect the AC adaptor. Doing so can result in loss of data.

**6 To play back the recorded Song, press [START/STOP].**

When playing back the recorded Song, pressing [R/1] or [L/2] allows you to mute Part 1 or Part 2. Each time the button is pressed, playback/mute is switched.

## Clearing a User Song

- 1 Press [SONG]/[STYLE] so that **SONG** icon appears.



- 2 From among the SONG category buttons, press [USER&STORAGE] to select the desired Song.

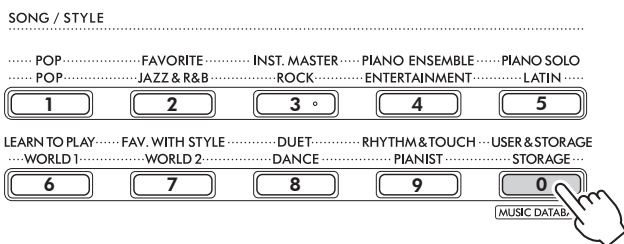

- 3 While holding down [SHIFT], press [REC].

A confirmation message appears.

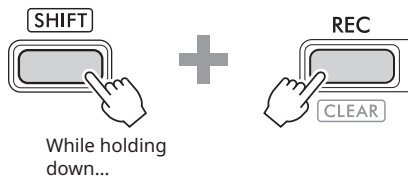

To cancel the operation, press [-/NO].

- 4 Press [+ / YES].

A confirmation message appears.



To cancel the operation, press [-/NO].

- 5 Press [+ / YES] to clear the Song.

"Writing!" appears while the Song is being cleared.

# Memorizing Your Favorite Settings (Registration Memory)

This instrument has a Registration Memory feature that lets you memorize your favorite settings for easy recall whenever they're needed. Although 10 complete setups have been memorized by default, you can replace them with your original settings.

## Recalling Panel Settings from the Registration Memory

### 1 Press [REGIST MEMORY].

The SONG/STYLE category buttons now function as numeric buttons as engraved on each button.

"LoadNo.?" appears on the display.

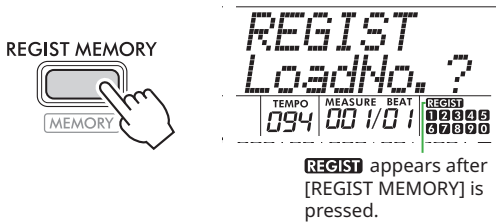

### 2 From among the SONG/STYLE category buttons, press either of [1]-[0] buttons to load the settings.

The display shows the recalled Registration Memory number and the Voice Name registered to the selected Registration Memory.

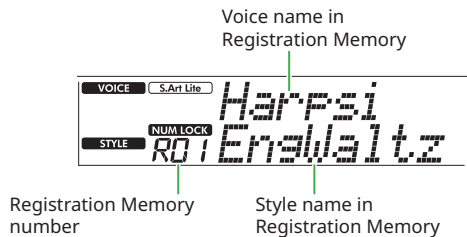
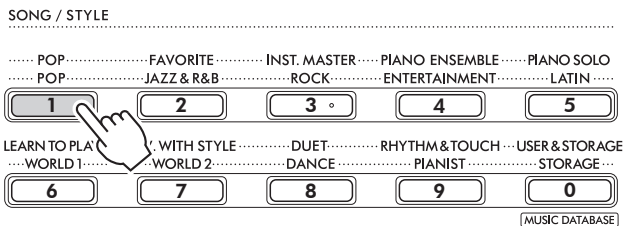

The Registration Memory number can be changed by pressing one of the other numeric buttons.

### 3 To exit from this status, press [REGIST MEMORY].

## Factory settings

Registration Memory Number	Voice Name in Memory
R01	S.Art Lite Harpsichord
R02	S.Art Lite Nylon Guitar Harmonics
R03	S.Art Lite Steel Guitar Harmonics
R04	S.Art Lite Distortion Guitar
R05	S.Art Lite Slap Bass
R06	S.Art Lite Strings
R07	S.Art Lite Gospel Choir
R08	S.Art Lite Tenor Sax
R09	S.Art Lite Brass Section
R00	S.Art Lite Flute

## Parameters that are memorized to Registration Memory

### ● Voice settings

- Main Voice settings: Voice number and all settings of the related Functions
- Dual Voice settings: Dual on/off and all settings of the related Functions
- Split Voice settings: Split on/off and all settings of the related Functions

### ● Effect settings

Reverb Type, Reverb level, Chorus Type, DSP on/off, DSP Type, Sustain on/off

### ● Harmony/Arpeggio settings

Harmony/Arpeggio on/off and all settings of the related Functions

### ● Style settings\*

Style number, ACMP on/off, Style volume, Tempo, Main A/B, Fingering Type, Style Key, Auto Chord Play On/Off, Chord Progression

### ● Other settings

Transpose, Split Point, all settings for the Function "DUO," Pedal Function

\* When a Song is selected, the Style settings cannot be recorded or called up.

## Memorizing Panel Settings to Registration Memory

- 1 Make the desired panel settings, such as for Voice and Style.
- 2 While holding down [SHIFT], press [REGIST MEMORY].  
The SONG/STYLE category buttons now function as numeric buttons as engraved on each button.  
"MemNo.?" appears on the display.

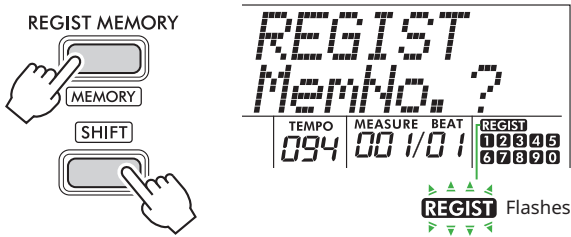

- 3 From among the SONG/STYLE category buttons, press one of [1]–[0] to memorize the current panel settings.

If you select a Registration Memory number that already contains data, "Overwrt?" appears in the display. To overwrite, press [+ / YES]; to cancel, press [- / NO].

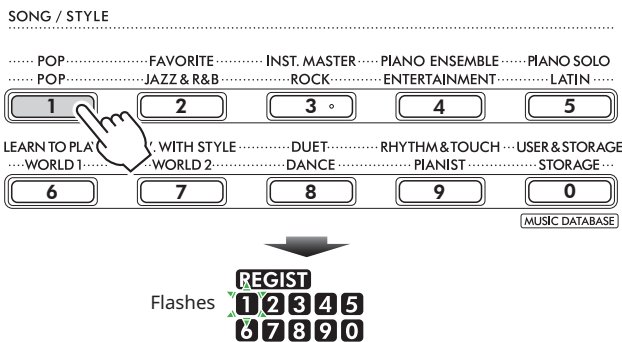

While memorizing, "MemOK" appears on the display and the number icon corresponding to the number selected in this step flashes. When memorizing is completed, the number icon lights up.

### NOTICE

- If you select a Registration Memory number that already contains data, the previous data is deleted and overwritten by the new data.
- To restore all Registration Memories to the factory settings, execute the Backup Clear operation.
- Do not turn off the power while "MemOK" appears on the display, otherwise the data may be damaged or lost.

## Deleting a Registration Memory

- 1 While holding down [SHIFT], press [REGIST MEMORY].  
The SONG/STYLE category buttons now function as numeric buttons as engraved on each button.  
"MemNo.?" appears on the display.

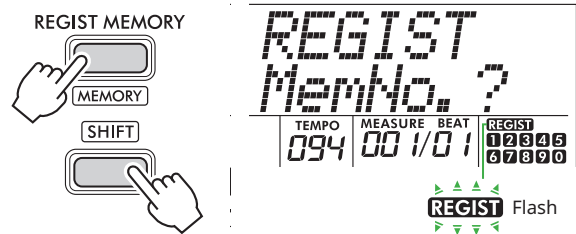

- 2 While holding down [SHIFT], press the desired number to be deleted from among the SONG/STYLE category buttons [1]–[0].

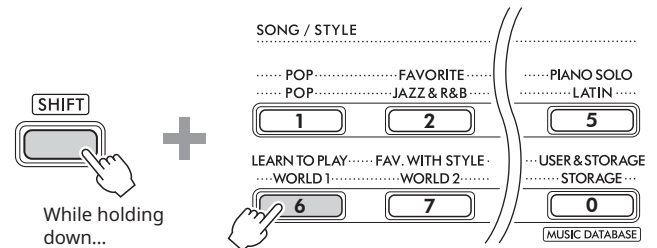

"ClrRegX?" ("X" represents the Registration Memory number) appears in the display.

- 3 Press [+ / YES] to delete the Registration Memory.

Press [- / NO] to cancel the delete operation. When deleted, the Registration Memory number on the display disappears.



## Disabling Recall of Specific Items (Freeze)

Registration Memory lets you recall all the panel setups you made with a single button press. However, there may be times that you want certain items to remain the same, even when switching Registration Memory setups. When you want to switch the Voice settings but still maintain the Style settings, for example, you can "freeze" only the Style settings and have those Style settings remain, even when you select another Registration Memory number. Select the items you want to freeze via Function numbers 052, 053, and 054 (page 64).

# Connecting to Other Devices

## ⚠ CAUTION

- Before connecting, turn off the power of both this instrument and the other audio device. Also, before turning the power on or off, make sure to set all volume levels to minimum (0). Otherwise, damage to the devices, electrical shock, or even permanent hearing loss may occur.

## Connecting Headphones or External Speakers (sold separately)

### Connection Options

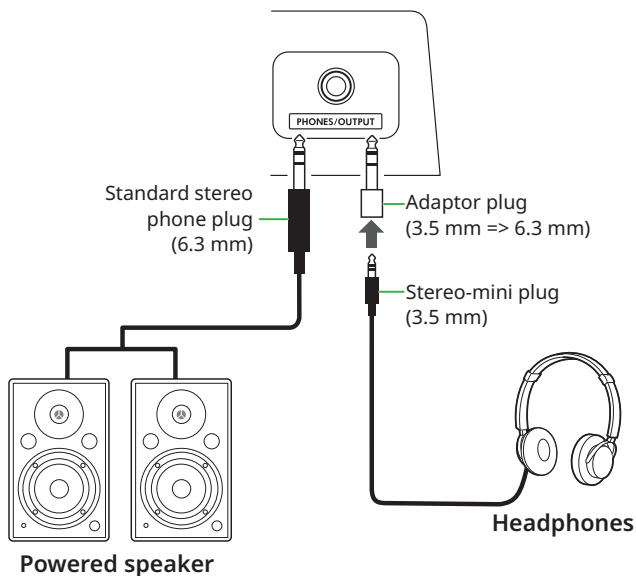

The [PHONES/OUTPUT] jack can be connected to a pair of headphones as well as an external audio devices, such as powered speakers and keyboard amplifiers. This lets you hear the sound of this instrument via those devices. The speakers of this instrument are shut off while this jack is plugged.

## ⚠ CAUTION

- Do not use the instrument or headphones for a long period of time at a high or uncomfortable volume level, since this can cause permanent hearing loss.

## NOTICE

- To avoid damage to the devices, first turn on the power to the external device, and then to the instrument. When turning off the power, do in reverse: first turn off the power to the instrument, and then to the external device.

## Using a Pedal (Footswitch)

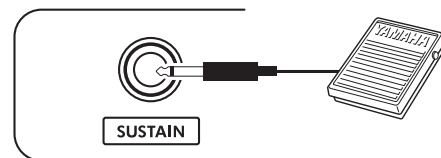

By connecting a Footswitch (FC5 or FC4A; sold separately) to this jack, you can control one of three functions: Sustain, Articulation ([page 22](#)), and Arpeggio ([page 23](#)). By default, Sustain is assigned, so that the sound can be heard for a long time even if you take your finger off the keyboard while pressing the foot switch, like a damper pedal on a piano. To use another function, call up the Function settings display (Function 033; [page 63](#)).

### NOTE

- Plug or unplug the footswitch while the power is off. Also, do not press the footswitch when turning the power on. Doing so changes the polarity of the footswitch, resulting in reversed operation.
- The Sustain function affects Main Voices ([page 18](#)) or Dual Voices ([page 19](#)), not Split Voices ([page 20](#)) or Styles (Auto Accompaniment; [page 30](#)).

## Playing an Audio Device with this instrument

You can output the sound of an audio device, such as a smartphone, with the built-in speakers of this instrument by connecting it via a cable. This lets you play the keyboard along with playback of your music player.

### NOTICE

- To avoid damage to the external audio device and this instrument, first turn on the power to the external device, and then to the instrument. When turning off the power, first turn off the power to the instrument, and then to the external device.

### NOTE

- If you are using a computer or a smart device such as a smartphone or tablet, etc., you can also connect it to the [USB TO HOST] terminal (pages 56, 59).

**1 Turn off the power for both the external audio device and this instrument.**

**2 Connect the audio device to the [AUX IN] jack.**

Use the cable (having no or zero resistance) which has a stereo-mini plug at one side for connecting to this instrument and a plug matching the output jack of the external audio device at the other side.

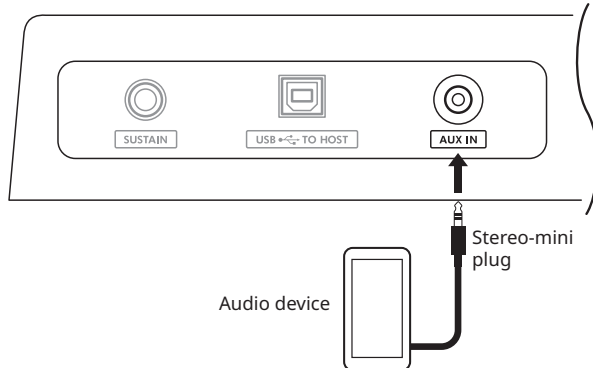

**3 Turn on the external audio device, and then this instrument.**

**4 Play back the connected external audio device.**

The sound of the audio device is output through the speakers of this instrument.

**5 Adjust the volume balance between the external audio device and this instrument.**

Adjust the audio playback volume on the audio device, and then adjust the entire volume by rotating the [MASTER VOLUME] control of the instrument.

### NOTE

- You can adjust the level of the input from the external audio device by calling up "AuxInVol" via Function number 047 (page 64) and using the [+ / YES] and [- / NO] buttons. If you increase the volume to more than 50, the audio device sound may be distorted.

**6 Play the keyboard along with the sound of the audio device.**

You can cancel or lower the volume of the melody part of audio playback. For details, refer to page 59.

**7 After finishing your performance or practice, stop playback of the audio device.**

## Connecting to a Computer via USB

This allows you to perform the following operations.

- Copying the MIDI file (Song and Style) between the computer and the instrument via computer operation
- Copying a Backup file (page 66) between the computer and the instrument via computer operation
- Communication of MIDI messages such as playback or keyboard performance
- Communication of Audio playback (as an USB audio interface)

### Connection Option

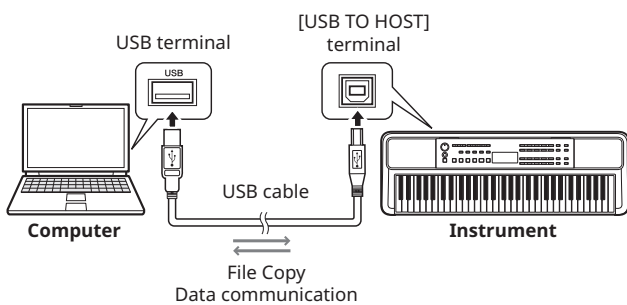

### Precautions when using the [USB TO HOST] terminal

#### NOTICE

- When connecting, use an AB type USB cable of less than 3 meters.
- Before plugging/unplugging a USB cable, quit any open application software on the computer.
- Wait for six seconds or more between the following operations: (1) when turning the power of the instrument off and then on again, or (2) when alternately plugging/unplugging a USB cable.

If the computer or the product freezes, restart the application software or OS of the computer, or turn the power to this product off and then on again.

## Copying the desired files from/to the computer

This section explains the following operations.

- Copying MIDI files (Song and Style) from the computer to the instrument and vice versa
- Copying the Backup file (.BUP; page 66) from the instrument to the computer and vice versa

**1 Turn off the power of the instrument.**

**2 Connect the USB cable first to the [USB TO HOST] terminal (page 11) of the instrument, and then to the USB terminal of the computer.**

**3 Turn on the power of the instrument.**

**4 Press [FUNCTION] to call up the Function display (page 60).**



**5 Press [+] / [-] until "Storage" (Function 061; page 65) is shown on the upper row of the display.**

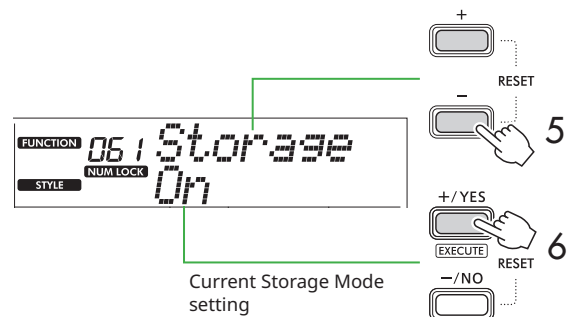

**6 Press [+ / YES] to turn on the Storage Mode.**

After "Wait..." is shown, the Storage Mode is turned on.

**7 From the computer screen, find the Backup file (.BUP).**

After entering the Storage Mode in Step 6, the drive for the instrument (YAMAHA PK) is created and the Explorer application starts automatically on the computer screen. The Backup file is named as follows:

The Backup file is named as follows:

- EZ-310.BUP

#### Example: Windows 10

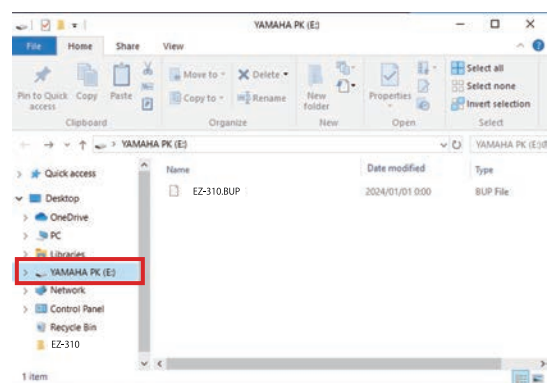

#### NOTE

- If an error message appears by turning on the Storage Mode, the instrument does not contain enough free space. If this happens delete Song files and Style files on the computer to free up enough space on the instrument, and then go to the next step.



## 8 From the computer, perform the File Copy operations.

- When you want to use the Song or Style file on the computer, copy the desired file from the computer drive to the instrument drive.
- When saving the Backup file on the instrument to the computer, copy the Backup file (.BUP) on the instrument drive to the computer drive.



## 9 After the Copy operation is completed, eject the instrument drive from the computer.

Below is an example from Windows 10.



## 10 On the instrument, press [-/NO] to turn the Storage Mode off.

After "Writing!" is shown, the Storage Mode is actually turned off.

## 11 Press [SHIFT] to return to the Home display (page 17).

## 12 Disconnect the USB cable.

## 13 Check whether the files are appropriately copied or not, by playing them back.

Since this instrument cannot be used while the Storage Mode is on, make sure to exit from the Storage Mode after the file operation is completed.

## NOTICE

- Before disconnecting the USB cable, make sure to eject the instrument drive from the computer as described in Step 9. Otherwise, files may be damaged.
- Never rename the Backup file (extension: .BUP) from the computer. Otherwise, Backup data will not be imported to the instrument even if you copy it and return it to the instrument the next time.
- When copying the Backup file back into this instrument, the settings previously stored in the instrument will be replaced with the new data. Note that User Songs and registered Style files will also be rewritten.
- Never create folders on the instrument drive. Otherwise, the instrument may not recognize the copied files correctly.
- Never format the instrument drive. Doing so may cause the instrument to malfunction.

## Files which can be copied (Total within about 1.5 MB)

### ● Song file (extension: .MID)

You can copy Song files created on other instruments or on your computer to this instrument. Note that User Songs created with this instrument cannot be copied to a computer as individual files.

### ● Style file (extension: .STY)

Regarding Style files, this instrument cannot create them but can load and play them back, as long as they are within 50 KB per a single file. Files exceeding this limit will not be recognized.

### ● Backup file (extension: .BUP)

Data in the instrument can be saved as a single Backup file. For target data, see "Backup data and Backup settings" (page 66).

## Checking files copied to the instrument

This section covers how to confirm whether files have been copied properly to this instrument or not.

### ● Song file

Songs copied from the computer will be stored to Song number 158 or later in the [USER&STORAGE] category.

1. Press [SONG]/[STYLE] so that "SONG" appears on the display.
2. Press [USER&STORAGE] to find and select the Song copied from the computer.
3. Press [START/STOP] to start playback.

#### NOTE

- Song files copied from the computer will be sorted in the order of symbols, numbers, and alphabetic letters.

### ● Style file

Regarding Style files copied from the computer, a registration operation is necessary. The instrument can register up to 10 Styles (Style numbers: 261 to 270), which can then be played in the same way as the preset Styles.

1. Press [SONG]/[STYLE] so that **STYLE** icon appears on the display.
2. Press [FUNCTION] several times until "StyleReg" (Function number 062; [page 65](#)) appears.

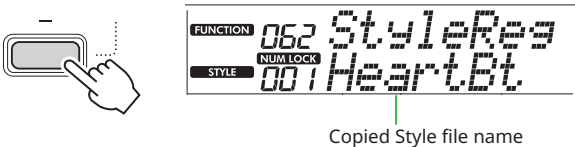

3. Press [+ / YES] / [- / NO] to select the file you want to register.
4. While holding down [SHIFT], press [+ / YES] to enter your selection. The display shows "\*\*\* Load To?" (\*\*\*: 261-270), allowing you to confirm the registration destination. Press [+ / YES] / [- / NO] to select the desired number as the destination.
5. While holding down [SHIFT], press [+ / YES]. "LoadOK?" appears on the display. To cancel this operation, simultaneously hold down [SHIFT] and press [- / NO].
6. While holding down [SHIFT], press [+ / YES] to execute the registration. After registration is completed, "Complete" appears on the display.
7. Press [SHIFT] to return to the Home display ([page 17](#)).
8. Press [USER&STORAGE] to select the registered Style, and then play it. For information about Style playback, see [page 32](#).

### ● Backup file

Check that the settings including recorded User Songs and registered Style files have been properly returned to the previous status when they were saved.

## Communication of MIDI messages

Since the instrument functions as a MIDI interface, MIDI Songs played on your computer can be heard on the instrument while your keyboard performance is simultaneously transmitted to the computer as MIDI data.

## Communication of Audio playback (USB audio interface function)

Since the instrument functions as an audio interface, audio played on your computer can be heard on the instrument while audio of your keyboard performance is simultaneously transmitted to the computer.

For Windows, the dedicated USB driver "Yamaha Steinberg USB Driver" is necessary for audio communication. On the website below, search for "Yamaha Steinberg USB Driver" and install it on the computer. For instructions on installing the driver, refer to the Installation Guide included with the download file.

<https://download.yamaha.com/>

For Mac, driver installation is not necessary since the standard driver provided with macOS is used.

### NOTICE

- When using the instrument with a music production application such as a DAW (Digital Audio Workstation), turn off "Audio Loopback" (Function number 049; [page 64](#)). If you turn it on, audio from the computer as well as instrument sounds will be returned to the DAW, which may cause howling or abnormal doubling noises.

#### NOTE

- Although the volume can be adjusted separately via respective controllers of the computer and instrument, the volume of the audio input via the [USB TO HOST] terminal can be adjusted via "[USB TO HOST] Audio Volume" (Function number 048; [page 64](#)).
- The [MASTER VOLUME] dial cannot adjust the output volume of Audio coming from the computer via the [USB TO HOST] terminal. Keep this in mind when recording your keyboard performance to the DAW as it is mixed with the computer audio.

## Connecting a Smart Device

By connecting a smart device such as a smartphone or tablet to the instrument, you can take advantage of various functions. For details on connections, refer to “Smart Device Connection Manual” (page 2) on the website.

### Compatible Apps

#### • MusicSoft Manager

Lets you transfer externally created Song and Style data (MIDI) from the smart device to the instrument, and save the Backup files (.BUP) of the instrument to the smart device.

#### • Rec’n’Share

Lets you photograph/record/edit your keyboard performance and upload the data to the Internet such as SNS.

For information about compatible smart devices and apps, access the following page:

<https://www.yamaha.com/kbdapps/>

#### NOTE

- Use an AB type USB cable of less than 3 meters.
- USB 3.0 cables cannot be used.
- You can adjust the level of the audio input via [USB TO HOST] terminal via the Function setting display (Function 048; page 64).

## Lowering the volume of a melody part (Melody Suppressor function)

When using this instrument to playback audio of an external audio device or computer connected to the [AUX IN] jack or the [USB TO HOST] terminal, you can cancel or lower the volume of only the melody part of audio playback. This is useful for practicing the melody part along with audio playback.

- 1 Play back audio on the connected external device.
- 2 Press [FUNCTION] to call up the Function display (page 60).
- 3 Press [+] / [-] until “MelodySP” (Function 050; page 64) is shown on the upper row of the display.

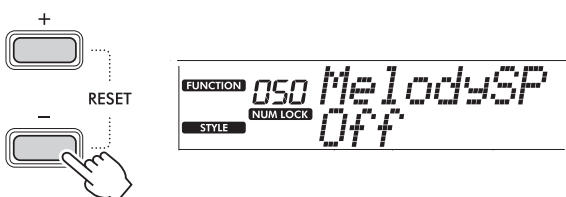

- 4 Press [+] / [YES] to select “On.”

#### NOTE

- When the computer is connected to the [USB TO HOST] terminal, the Melody Suppressor function can be used only when Audio Loop Back (Function 049; page 64) is set to “On.”

- 5 To cancel the Melody Suppressor function, press the [-] / [NO] button to select “Off.”

### When the melody or vocal sound is not canceled (or lowered)

Adjust the stereo location so that the melody sound is suppressed.

- 1 Turn the Melody Suppressor function on via the steps 2–4 above.
- 2 Press [+] / [-] until “SupprPan” (Function 051; page 64) is shown on the upper row of the display.

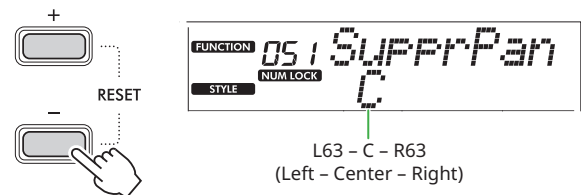

- 3 Adjust the pan position of the sound to be cancelled (lowered) by using [+] / [YES] / [-] / [NO].

#### NOTE

- Depending on the particular music content, the melody or vocal sound may not be canceled as expected even if Melody Suppressor is turned on.

# The Functions

The “Functions” provide access to a range of detailed instrument parameters such as Tuning, Split Point, Voices, and Effects. Find the desired item in the Function List (pages 60–65), and then follow the instructions below.

## 1 Press [FUNCTION] to call up the Function Settings display.

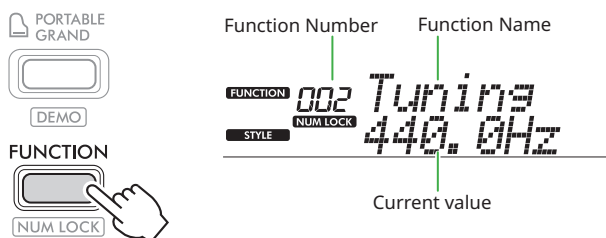

## 2 Press [+]/[-] until the desired Function number and name are shown on the upper row of the display.

Holding down the button will change the number continuously.

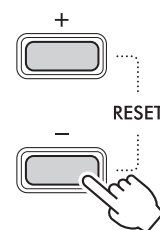

## 3 Press [+ / YES] / [- / NO] to set the value shown on the lower row of the display.

Holding down the button will change the number continuously.

Pressing [+ / YES] and [- / NO] simultaneously restores the default setting.

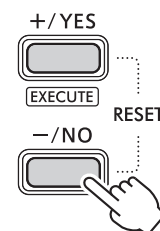

## 4 To exit the Function settings display, press [FUNCTION] or [SHIFT].

### Selecting Function numbers and values numerically

While the **NUM LOCK** icon called up via [FUNCTION] is shown on the display, you can use the VOICE category buttons and SONG/STYLE category buttons as numeric buttons.

- **Function number:** Select by using the VOICE category buttons.
- **Setting value:** Set by using the SONG/STYLE category buttons.

## Function List

Function Number	Function Name	Display	Range/Settings	Default Value	Descriptions	Backup ✓: Yes
<b>Overall</b>						
001	Transpose	<i>TransPos</i>	-12-+12	0	Sets the pitch in semitones.	
002	Tuning	<i>Tuning</i>	427.0 Hz-453.0 Hz	440.0 Hz	Determines the pitch of the entire instrument in increments of approximately 0.2 Hz.	✓
003	Split Point	<i>SplitPnt</i>	36-96 (C1-C6)	54 (F#2)	Determines the point for dividing the keyboard into the Split Voice area and Main/Dual Voice area (page 20). This setting is applied to the Accompaniment Split Point setting (page 32).	✓
004	Touch Response	<i>TouchRes</i>	1: Soft 2: Medium 3: Hard 4: Off	2: Medium	Determines the sensitivity when playing the keyboard (the rate at which the volume changes depending on the strength with which you play the keyboard). For details, refer to page 21.	✓

Function Number	Function Name	Display	Range/Settings	Default Value	Descriptions	Backup ✓ : Yes
<b>Main Voice</b>						
005	Volume	<i>M. Volume</i>	0-127	*	Determines the volume of the Main Voice.	
006	Octave	<i>M. Octave</i>	-2-+2	*	Determines the octave range for the Main Voice.	
007	Reverb Depth	<i>M. Reverb</i>	0-127	*	Determines the amount of Reverb applied to the Main Voice.	
008	Chorus Depth	<i>M. Chorus</i>	0-127	*	Determines the amount of Chorus applied to the Main Voice.	
<b>Dual Voice</b>						
009	Volume	<i>D. Volume</i>	0-127	*	Determines the volume of the Dual Voice.	
010	Octave	<i>D. Octave</i>	-2-+2	*	Determines the octave range of the Dual Voice.	
011	Reverb Depth	<i>D. Reverb</i>	0-127	*	Determines the amount of Reverb applied to the Dual Voice.	
012	Chorus Depth	<i>D. Chorus</i>	0-127	*	Determines the amount of Chorus applied to the Dual Voice.	
<b>Split Voice</b>						
013	Volume	<i>S. Volume</i>	0-127	*	Determines the volume of the Split Voice.	
014	Octave	<i>S. Octave</i>	-2-+2	*	Determines the octave range of the Split Voice.	
015	Reverb Depth	<i>S. Reverb</i>	0-127	*	Determines the amount of Reverb applied to the Split Voice.	
016	Chorus Depth	<i>S. Chorus</i>	0-127	*	Determines the amount of Chorus applied to the Split Voice.	
<b>Style</b>						
017	Style Volume	<i>StyleVol</i>	0-127	100	Determines the volume of the Style playback.	✓
018	Fingering Type	<i>FingType</i>	1: Smart Chord 2: Multi Finger	1: Smart Chord	This determines the method for playing chords (Fingering Type) in the Auto Accompaniment area. For details, refer to <a href="#">page 31</a> .	✓
019	Style Key	<i>StyleKey</i>	FL7-SP0-SP7 FL7 (7 Flats ♭) : Key of C♭ major /A♭ minor SP0 (No Key Signature) : C major/A minor SP7 (7 Sharps #) : C♯ major/A♯ minor	SP0 (No Key Signature): Key of C major/A minor	This setting, which is available when “Smart Chord” is selected as the Fingering Type, determines the key signature of the Song by selecting the number of sharps (#) or flats (♭) shown on the music score. If the setting here is correct, simply playing only the root note of a chord will play back various chord types specified at each timing of the Song. • FL7-FL1: Select when a flat or flats (♭) are described on the score • SP0: Select when no sharps or flats are described on the score • SP1-SP7: Select when a sharp or sharps (#) are described on the score	
020	Chord Progression	<i>ChdProg.</i>	Refer to the Data List on the website.	01	Determines the chord progression for playback via the Auto Chord Play function ( <a href="#">page 30</a> ). For details, refer to the Data List ( <a href="#">page 2</a> ) on the website.	

Function Number	Function Name	Display	Range/Settings	Default Value	Descriptions	Backup ✓ : Yes
<b>Song</b>						
021	Song Volume	<i>SongVol</i>	0-127	100	Determines the volume of the Song.	✓
022	Song Melody Voice	<i>MelodyVc</i>	001-650	**	Lets you change the Melody Voice of the preset Song to the desired one. For details, refer to <a href="#">page 40</a> .	
<b>Effects</b>						
023	Reverb Type	<i>Reverb</i>	01-04: Hall 1, 2, 3, 4 05: Cathedral 06-09: Room 1, 2, 3, XG 10-12: Stage 1,2, XG 13-15: Plate 1, 2, XG 16: Off	**	Lets you select the Reverb type ( <a href="#">page 27</a> ). For details, refer to the Data List ( <a href="#">page 2</a> ) on the website.	
024	Reverb Level	<i>RevLevel</i>	0-127	64	Determines the Reverb Level applied to the entire sound of this instrument.	
025	Chorus Type	<i>Chorus</i>	1-3: Chorus 1, 2, 3 4-6: Flanger 1, 2, XG 7: Celeste XG 8: Off	**	Lets you select the Chorus type ( <a href="#">page 27</a> ). For details, refer to the Data List ( <a href="#">page 2</a> ) on the website.	
026	DSP Type	<i>DSPTypE</i>	01-41	*	Lets you select the DSP type ( <a href="#">page 26</a> ). For details, refer to the Data List ( <a href="#">page 2</a> ) on the website.	
027	Panel Sustain	<i>Sustain</i>	On/Off	Off	Determines whether the Sustain function is on or off ( <a href="#">page 28</a> ).	✓
028	Master EQ Type	<i>MasterEQ</i>	1: Standard 2: Boost 3: Piano 4: Bright 5: Mild	1: Standard	Lets you select what type of equalization is applied to the speaker output, etc. for optimum sound in different listening situations. For details, refer to <a href="#">page 28</a> .	✓
<b>Harmony/Arpeggio</b>						
029	Harmony/Arpeggio Type	<i>Harm/Arp</i>	001-026 (Harmony) 027-178 (Arpeggio)	*	Lets you select the Harmony or Arpeggio type. For details, refer to the Data List ( <a href="#">page 2</a> ) on the website.	
030	Harmony Volume	<i>HarmVol</i>	0-127	*	Determines the volume of the Harmony effect.	
031	Arpeggio Velocity	<i>ArpVelo</i>	1: Original 2: Key	**	Selects how to determine the Arpeggio Velocity (strength). • 1 (Original): Uses the default value for each Arpeggio type. • 2 (Key): Uses the velocity (strength) of the pressed key.	
032	Arpeggio Quantize	<i>Quantize</i>	1: Off 2: 1/4 3: 1/8 4: 1/16	**	Lets you change the note type, with which the Arpeggio playback timing is synchronized with Song/Style playback. • 1 (OFF): No synchronization. • 2 (1/4): Synchronizes to 4th notes. • 3 (1/8): Synchronizes to 8th notes. • 4 (1/16): Synchronizes to 16th notes.	

Function Number	Function Name	Display	Range/Settings	Default Value	Descriptions	Backup ✓: Yes
<b>Pedal</b>						
033	Pedal Function	<i>PdIFunc</i>	1: Sustain 2: Arpeggio Hold 3: Sustain+Arpeggio Hold 4: Articulation	1: Sustain	Lets you select the function assigned to the footswitch connected to the [SUSTAIN] jack. <ul style="list-style-type: none"> <li>• 1 (Sustain): While pressing the footswitch, you can hear a note sustain even after releasing the keys.</li> <li>• 2 (Arpeggio Hold): While pressing the footswitch, the Arpeggio playback continues even if releasing the keys.</li> <li>• 3 (Sus+ArpeggioH): Both Functions described in 1 and 2 above are applied simultaneously.</li> <li>• 4 (Art.): While pressing the footswitch, an Articulation effect is applied.</li> </ul>	
<b>Metronome</b>						
034	Time Signature Numerator	<i>TimeSigN</i>	0-60	**	Determines the beat of the Metronome.	
035	Time Signature Denominator	<i>TimeSigD</i>	2: Half note 4: Quarter note 8: Eighth note 16: Sixteenth note	**	Determines the type of notes per beat of the metronome.	
036	Metronome Volume	<i>MetroVol</i>	0-127	100	Determines the volume of the Metronome.	✓
<b>Lesson</b>						
037	Lesson Track (R)	<i>R-Part</i>	1-16	1	Determines the channel number for your right-hand lesson when using the Lesson function with the Songs in SMF format 0 copied from a computer. After selecting the desired Song, call up this display and then use [+ /YES] /[- /NO] to select the desired channel number. We recommend that you select channel 1 for the right-hand part and select channel 2 for the left-hand part.	
038	Lesson Track (L)	<i>L-Part</i>	1-16	2	Determines the channel number for your left-hand lesson when using the Lesson function with the Songs in SMF format 0 copied from a computer. After selecting the desired Song, call up this display and then use [+ /YES] /[- /NO] to select the desired channel number. We recommend that you select channel 1 for the right-hand part while you select channel 2 for the left-hand part.	
039	Your Tempo	<i>YourTemp</i>	On/Off	On	This parameter is for Lesson 3 "Waiting." When this is set to "On," playback tempo will change to match your playing speed. When this is set to "Off," playback tempo will be maintained regardless of your playing speed.	✓
040	Guide	<i>Guide</i>	On/Off	On	Determines whether the Guide note sounds (On) or not (Off) during the "Waiting" lesson.	✓

Function Number	Function Name	Display	Range/Settings	Default Value	Descriptions	Backup ✓ : Yes
<b>Light Guide (Lighting Keyboard)</b>						
041	Light Guide	<i>Light</i>	On/Off	On	Turns the Light Guide function (page 15) on/off.	
042	Light Part 1 Setting	<i>LightPt1</i>	1-16	1	Determines the 1st part (channel) which lights the keyboard when playing a MIDI Song contained on the computer with this instrument.	
043	Light Part 2 Setting	<i>LightPt2</i>	1-16	2	Determines the 2nd part (channel) which lights the keyboard when playing a MIDI Song contained on the computer with this instrument.	
<b>MIDI</b>						
044	Local Control	<i>Local</i>	On/Off	On	Determines whether the instrument's keyboard controls the internal tone generator (On) or not (Off).	
045	External Clock	<i>ExtClock</i>	On/Off	Off	Determines whether Song/Style playback synchronizes to the internal clock of this instrument (Off) or an external clock (On).	
046	Initial Send	<i>InitSend</i>	YES/NO	-	Allows you to send the data of the panel settings to a computer. Press [+ / YES] to send, or press [- / NO] to cancel.	
<b>Audio</b>						
047	[AUX IN] Audio Volume	<i>AuxInVol</i>	0-127	50	Determines the volume of audio playback input to the instrument via the [AUX IN] jack (page 55).	✓
048	[USB TO HOST] Audio Volume	<i>USBInVol</i>	0-127	100	Determines the volume of audio playback input to the instrument via the [USB TO HOST] terminal (pages 58, 59).	✓
049	Audio Loop Back	<i>Loopback</i>	On/Off	On	Determines whether audio input via the [USB TO HOST] terminal is returned to the computer (On) or not (Off) mixed with the audio of the instrument. If you want to output only the sound only of the instrument to the computer, select "Off".	✓
050	Melody Suppressor	<i>MelodySP</i>	On/Off	Off	When using this instrument to playback audio of an external audio device or computer connected to the [AUX IN] jack or the [USB TO HOST] terminal, you can cancel or lower the volume of only the melody part of audio playback by selecting "On" here (page 59).	
051	Suppressor Pan	<i>SupprPan</i>	L63-C-R63	C	Determines the pan position of the playback sound of the external audio device to be canceled or lowered (page 59).	
<b>Regist Freeze</b>						
052	Style Freeze	<i>StyleFrz</i>	On/Off	Off	When you want to call up a Registration Memory without overwriting the current Style setting, select "On."	✓
053	Transpose Freeze	<i>TransFrz</i>	On/Off	Off	When you want to call up a Registration Memory without overwriting the current Transpose setting, select "On."	✓
054	Voice Freeze	<i>VoiceFrz</i>	On/Off	Off	When you want to call up a Registration Memory without overwriting the current Voice setting, select "On."	✓



Function Number	Function Name	Display	Range/Settings	Default Value	Descriptions	Backup ✓ : Yes
<b>Duo</b>						
055	Duo Split Point	<i>DuoPnt</i>	36-96 (C1-C6)	66 (F#3)	Lets you set the key that divides the keyboard range into the left player section and right player section (page 29).	
056	Duo R Volume	<i>DuoRVol</i>	0-127	*	Determines the volume of the right player section.	
057	Duo L Volume	<i>DuoLVol</i>	0-127	*	Determines the volume of the left player section.	
058	Duo R Octave	<i>DuoROct</i>	-3-+3	*	Determines the pitch of the right player section in octave units.	
059	Duo L Octave	<i>DuoLOct</i>	-3-+3	*	Determines the pitch of the left player section in octave units.	
060	Duo Type	<i>DuoType</i>	1: Balance 2: Separate	2: Separate	Lets you select how the sound is output via the built-in speaker while using the Duo. For details, refer to page 29.	
<b>Storage</b>						
061	Storage Mode	<i>Storage</i>	On/Off	Off	When copying Song or Style files between the instrument and the computer, set this to "On." You cannot play the instrument while this is set to "On."	
<b>Style File</b>						
062	Style Register	<i>StyleRes</i>	001- <i>nnn</i>	-	Lets you individually register Style files copied from the computer, to this instrument individually (page 58).	
<b>Demo</b>						
063	Demo Group	<i>DemoGrp</i>	1: Demo 2: Preset 3: User 4: Storage	1: Demo	Determines the repeat playback group. For details, refer to page 39.	✓
064	Demo Play Mode	<i>PlayMode</i>	1: Normal 2: Random	1: Normal	Determines the Song order for continuous playback. • 1 (Normal): Playback in the order of Song numbers • 2 (Random): Playback in random order	✓
<b>Battery</b>						
065	Auto Power Off Time	<i>AutoOff</i>	Disabled, 5/10/15/30/60/120 (minutes)	15 minutes	Lets you select the time that elapses from the last operation performed until the instrument is automatically turned off.	✓
066	Battery Type	<i>Battery</i>	1: Alkaline 2: Ni-MH	1: Alkaline	Lets you select the type of batteries to use.	✓

\* The appropriate value is automatically set for each Voice combination.

\*\* The appropriate value is automatically set for each Song, Style or Arpeggio.

# Backup and Initialization

## Backup data and Backup settings

The data and settings listed below will be maintained even when the instrument is turned off. The storage area of these consists of the Backup area and Flash area.

### Backup area (Target items of "Backup Clear" described later)

- User Songs (page 49)
- Style numbers 261-270 (page 58)
- Registration Memory (page 52) \*1
- Various settings in the Functions (page 60) \*1 \*2
- Passing Status of Keys to Success (page 45) \*1

\*1 Saved or overwritten into the Backup file (.BUP) when turning off the power.

#### NOTICE

When the instrument is turned off in the following situations, Backup will not be executed, with the result that items listed above may be lost.

- When unplugging the AC adaptor while the instrument is on
- When outage occurs
- When battery shortage occurs while the instrument is powered only by batteries
- When plugging the AC Adaptor while the instrument is powered only by batteries

\*2 Items for which a checkmark is entered in "Backup" column of the Function List (pages 60-65).

### Flash area (Target items of "Flash Clear" described later)

- All Song files copied from computer (page 58)
- All Style files copied from computer (page 58)

## Backup file (.BUP)

- By turning on the Storage Mode (page 56), all data and settings in the Backup area will be saved to the Flash area as a single archived file which is referred to as "Backup file" (.BUP). This file, for future recall, can be copied to an external computer or smart device as backup.
- The Backup file (.BUP) saved or backed up in the computer or smart device can be recalled back to the instrument as necessary. To do this, turn on the Storage Mode (page 56) on the instrument, replace the Backup file (.BUP) on the instrument drive with the one on the computer drive, and then turn off the Storage Mode to reflect the data and settings to the Backup area.

For detailed instructions on copying the Backup file, refer to page 56.

#### NOTE

- The size of the Backup file (.BUP) is determined by the data capacity which has been created or saved in the instrument. Maximum size is approximately 618 KB.

## Initializing the instrument

Backup data and Backup settings can be initialized respectively via the following operations.

### Backup Clear

This operation initializes all the data and settings in the Backup area. To do this, simultaneously hold down the highest white key and press [⏻] (Standby/On) to turn the instrument on.



### Flash Clear

This operation deletes all the data in the Flash area. To do this, simultaneously hold down the highest white key and the three highest black keys, and press [⏻] (Standby/On) to turn the instrument on.

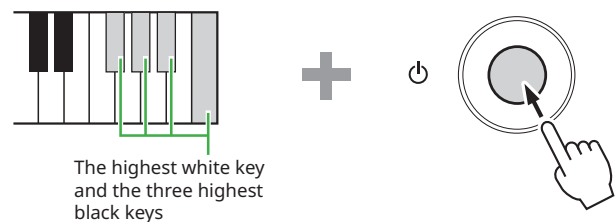

#### NOTICE

- Before executing Backup Clear or Flash Clear, make sure to save important data to a computer or smart device as required. This is because the Clear operation may also delete data you have purchased.

# Troubleshooting

Problem	Possible Cause and Solution
When the instrument is turned on or off, a popping sound is temporarily produced.	This is normal and indicates that the instrument is receiving electrical power. When turning on the power, turn the [MASTER VOLUME] dial (page 8) all the way down.
Immediately after turning on the instrument, power is turned off suddenly and unexpectedly.	The protection circuit has been activated due to over current. This may occur when an AC adaptor other than the one specified is used, or the AC adaptor is damaged. Use the specified adaptor (page 70) only. If it should appear to be malfunctioning, discontinue use immediately and have it inspected by qualified Yamaha service personnel.
Power suddenly and unexpectedly turns off.	This is normal because the Auto Power Off function (page 7) may be enabled.
When using a mobile phone, noise is produced.	Using a mobile phone in close proximity to the instrument may produce interference. To prevent this, turn off the mobile phone or use it further away from the instrument.
Noise is heard from the instrument's speakers or headphones when using the instrument with an application on a smart device.	When you use the instrument along with an application on your smart device, we recommend that you set "Airplane Mode" to "ON" on your smart device in order to avoid noise caused by communication.
The application on your smart device doesn't recognize the instrument	The Storage Mode (Function 061; page 65) may be set to "On." Set this to "Off."
<ul style="list-style-type: none"> <li>• The volume is too soft.</li> <li>• The sound quality is poor.</li> <li>• The Song or Style stops unexpectedly or will not play.</li> <li>• The recorded data of the Song, etc. does not play correctly.</li> <li>• The LCD display suddenly goes dark, and all panel settings are reset.</li> </ul>	The batteries are low or depleted. Replace all batteries with completely new ones, or use the included AC adaptor.
No sound is produced even when the keyboard is played or when a Song or Style is being played back.	The [PHONES/OUTPUT] jack may have a plug connected. When a set of headphones is plugged into this jack, no sound is output.
	The Local Control (Function 044; page 64) may be set to "Off." If so, set to "On."
The instrument does not respond to operation.	The Storage Mode (Function 061; page 65) may be set to "On." If so, set to "Off."
Not all of the Voices seem to sound, or the sound seems to be cut off.	The instrument is polyphonic up to a maximum of 48 notes—including Dual voice, Split Voice, Style, Song, and Metronome. Notes exceeding this limit will not sound.
The Harmony doesn't sound.	The method of playing the Harmony types differs between 001–005, 006–012, and 013–026. Harmony types 001–005 work only when ACMP is on, while 006–026 work whether ACMP is on or off. Harmony types 006–012 work only when playing two notes simultaneously. For details, refer to page 24.

Problem	Possible Cause and Solution
Playback of Song/Style/Arpeggio/Metronome does not start regardless of the correct operation.	The External Clock (Function 045; <a href="#">page 64</a> ) may be set to "On.". If so, set to "Off."
The volume of the Style or Song is too low.	Check the volume setting for each function ( <a href="#">pages 61, 62</a> ).
The chords played in the left-hand area cannot be recognized even when ACMP is turned on.	The setting for Function 003 "Split Point" ( <a href="#">page 60</a> ) is not appropriate. Set it to an appropriate value.
Style parts other than the Rhythm part produce no sound.	When ACMP is on ( <b>ACMP</b> is shown on the display), play a chord at the left-hand area of the keyboard. When ACMP is not on, press [ACMP ON/OFF] so that <b>ACMP</b> appears ( <a href="#">page 32</a> ) and then play a chord at the left-hand area of the keyboard.
<b>ACMP</b> does not appear on the display even when pressing [ACMP ON/OFF].	The instrument is not in Style mode, but in Song mode instead. Press [SONG]/[STYLE] so that <b>STYLE</b> appears on the display, and then press [ACMP ON/OFF].
The Style does not play back according to the chord that is played.	The current Fingering Type ( <a href="#">page 31</a> ) does not match how the chords are being played. Check the settings.  If the Fingering Type ( <a href="#">page 31</a> ) is set to "Multi Finger (Multi)," the following responses to User operations may occur. However, this is normal. <ul style="list-style-type: none"> <li>• If similar chords are played in succession (such as a minor seventh chord followed by a minor chord with the same root note), the Style might not change.</li> <li>• If only two keys are played, the optimum chord will be detected based on the played chord immediately before.</li> <li>• If an octave is played, only the root note will be heard as Style playback.</li> </ul>
The footswitch (for sustain) seems to produce the opposite effect. For example, pressing the footswitch cuts off the sound and releasing it sustains the sounds.	The polarity of the footswitch is reversed. Make sure that the footswitch plug is properly connected to the [SUSTAIN] jack before turning on the power.
The tonal characteristic and volume of the Voice changes depending on the note.	This is normal. The AWM tone generation method uses multiple recordings (samples) of an instrument across the range of the keyboard; thus, the actual sound of the Voice may be slightly different depending on the note.

# Specifications

<b>Product Name</b>			Digital Keyboard
<b>Size/Weight</b>	Dimensions (W x H x D)		941 mm × 105 mm × 317 mm (37-1/16" × 4-1/8" × 12-1/2")
	Weight		4.6 kg (10 lb, 2 oz) (not including batteries)
<b>Control Interface</b>	Keyboard	Number of Keys	61
		Touch Response	Soft, Medium, Hard, Off
		Light Guide	Yes
	Display	Type	LCD (Liquid Crystal Display)
		Backlight	Yes
		Language	English
Panel	Language	English	
<b>Voices</b>	Tone Generator		AWM Stereo Sampling
	Polyphony (max.)		48
	Preset	Number of Voices	650 (258 Panel Voices + 25 Drum/SFX kits + 20 Arpeggio + 347 XGlite Voices)
	Compatibility		GM/XGlite
<b>Effects</b>	Types	Reverb	15
		Chorus	7
		DSP	41
		Master EQ	5
	Functions	Dual	Yes
		Split	Yes
		Duo	Yes
		Panel Sustain	Yes
		Arpeggio	152
		Harmony	26
		Melody Suppressor	Yes
		Articulation	Yes (12 Super Articulation Lite Voices)
	<b>Accompaniment Styles</b>	Number of Preset Styles	
Fingering		Smart Chord, Multi finger	
Style Control		ACMP ON/OFF, SYNC START, START/STOP, INTRO/ENDING/rit., MAIN/AUTO FILL	
External Styles		10	
Other Features		Music Database	200
		One Touch Setting (OTS)	Yes
		Auto Chord Play	50 Chord Progressions
Compatibility		Style File Format (SFF)	
<b>Songs (MIDI)</b>	Preset	Number of Preset Songs	125
	Recording	Number of Songs	5
		Number of Tracks	2
		Data Capacity	Approx. 10,000 notes
	Format	Playback	SMF (Format 0, Format 1)
		Recording	Original File Format

## Specifications

<b>Functions</b>	Registration Memory	Number of Memories	10	
	Lesson		KEYS TO SUCCESS, 3-Step Lesson (Listening, Timing, Waiting), A-B Repeat, Rhythm & Touch Tutor, Level 1/2	
	Demo		Yes	
	USB Audio (USB TO HOST)		44.1 kHz, 16 bit, stereo	
	Overall Controls	Metronome		Yes
		Tempo Range		11–280
		Transpose		-12 to 0, 0 to +12
		Tuning		427.0–440.0–453.0 Hz (approx. 0.2 Hz increments)
Miscellaneous	PIANO Button	Yes ([PORTABLE GRAND] Button)		
<b>Storage and Connectivity</b>	Storage	Internal Memory	Approx. 1.4 MB	
	Connectivity	DC IN		12 V
		Headphones/ Output		Standard stereo phone jack (PHONES/OUTPUT)
		Sustain Pedal		Yes
		AUX IN		Stereo mini jack
		USB TO HOST		Yes (MIDI/AUDIO)
<b>Sound System</b>	Amplifiers		2.5 W × 2	
	Speakers		12 cm x 2	
<b>Power Supply</b>	Power Supply	AC Adaptor	PA-130 or an equivalent recommended by Yamaha (Output : DC 12 V, 0.7 A or 1.0 A)	
		Batteries	Six "AA" size alkaline (LR6), manganese (R6), or Ni-MH rechargeable batteries (HR6)	
	Power Consumption		5 W (When using PA-130 AC adaptor)	
	Auto Power Off		Yes	
<b>Included Accessories</b>			<ul style="list-style-type: none"> <li>• Music rest</li> <li>• Owner's Manual</li> <li>• AC adaptor *(PA-130 or an equivalent recommended by Yamaha)</li> <li>• Online Member Product Registration</li> </ul> <p>*: May not be included depending on your particular area. Please check with your Yamaha dealer.</p>	
<b>Separately Sold Accessories (May not be available depending on your area.)</b>			<ul style="list-style-type: none"> <li>• AC adaptor: Users within U.S or Europe: PA-130 or an equivalent recommended by Yamaha Others: PA-3C, PA-130 or an equivalent recommended by Yamaha</li> <li>• Keyboard stand: L-2C</li> <li>• Headphones: HPH-150, HPH-100, HPH-50</li> <li>• Footswitch: FC4A, FC5</li> <li>• Keyboard bag: SC-KB630</li> </ul>	

\* The contents of this manual apply to the latest specifications as of the publishing date. To obtain the latest manual, access the Yamaha website then download the manual file. Since specifications, equipment or separately sold accessories may not be the same in every locale, please check with your Yamaha dealer.

# Index

## Numeics

3-Step Lesson ..... 47

## A-Z

### A

A-B Repeat ..... 41  
AC Adaptor ..... 6  
Arpeggio ..... 23  
Arpeggio Type ..... 24  
Articulation ..... 22  
Auto Accompaniment ..... 32  
Auto Accompaniment area ..... 32  
Auto Chord Play ..... 30  
AUTO FILL ..... 33  
Auto Power Off ..... 7  
AUX IN ..... 55

### B

Backup ..... 66  
Backup Clear ..... 66  
Backup file ..... 57, 58, 66  
Battery ..... 6  
Battery Type ..... 7

### C

Chord ..... 35, 36  
Chorus ..... 27  
Computer ..... 56  
Copy (File) ..... 56

### D

Data List ..... 2  
Demo ..... 65  
Display ..... 17  
DSP ..... 26  
Dual (Layer) ..... 19  
Dual Voice ..... 19  
Duo ..... 29

### E

ENDING ..... 33  
External Speaker ..... 54

### F

Fast Forward ..... 40  
Fast Reverse ..... 40  
Fingering Type ..... 31  
Flash Clear ..... 66  
Footswitch (Pedal) ..... 54  
Freeze ..... 53  
Function List ..... 60  
Functions ..... 60

### H

Harmony ..... 23  
Harmony Type ..... 24  
Headphones ..... 54

### I

Included Accessories ..... 2  
Initialization ..... 66  
INTRO ..... 33

### K

Keys To Success ..... 44

### L

Layer (Dual) ..... 19  
Lesson ..... 43  
Level ..... 40  
Light Guide ..... 15  
Listen ..... 47

### M

MAIN ..... 33  
Main Voice ..... 18  
Master EQ ..... 28  
Master Volume ..... 7  
Melody Suppressor ..... 59  
Metronome ..... 16  
Metronome Volume ..... 16  
MIDI ..... 58, 64  
Multi Finger ..... 31  
Music Database ..... 37  
Music Rest ..... 7

### O

One Touch Setting ..... 18  
OTS ..... 18

### P

Part (playback) ..... 41  
Part (recording) ..... 50  
Pause ..... 40  
Pedal (Footswitch) ..... 54  
Power ..... 6, 7

### R

Recording ..... 49  
Registration Memory ..... 52  
Reverb ..... 27  
Rhythm & Touch Tutor ..... 42

### S

S.Art Lite Voice ..... 22  
Section ..... 33  
Smart Chord ..... 31, 36  
Smart Device ..... 59  
Smart Device Connection Manual ..... 2  
Song ..... 12, 13, 38  
Song Book ..... 2  
Song Category ..... 38  
Song file ..... 57, 58  
Song Volume ..... 39, 62  
Specifications ..... 69  
Split ..... 20  
Split Point ..... 20, 32, 60  
Split Voice ..... 20  
Storage Mode ..... 56, 65  
Style ..... 12, 13, 30  
Style File ..... 37, 57, 58  
Style Key ..... 31  
Style Volume ..... 33, 61  
Sustain ..... 28  
Synchro Start ..... 32

### T

Tap Tempo ..... 15  
Tempo ..... 15  
Time Signature ..... 16  
Timing ..... 47  
Touch Response ..... 21  
Transpose ..... 60  
Troubleshooting ..... 67  
Tuning ..... 60

### U

USB Audio Interface function ..... 58  
User Song ..... 49

### V

Video Manual ..... 2  
Voice ..... 12, 13, 18  
Volume ..... 7  
Volume (Dual Voice) ..... 61  
Volume (Main Voice) ..... 61  
Volume (Metronome) ..... 16  
Volume (Song) ..... 39, 62  
Volume (Split Voice) ..... 61  
Volume (Style) ..... 33, 61

### W

Waiting ..... 47

© 2024 Yamaha Corporation

Published 05/2024

IP-A0