

POWER AMPLIFIER  
**T5n/T4n/T3n**

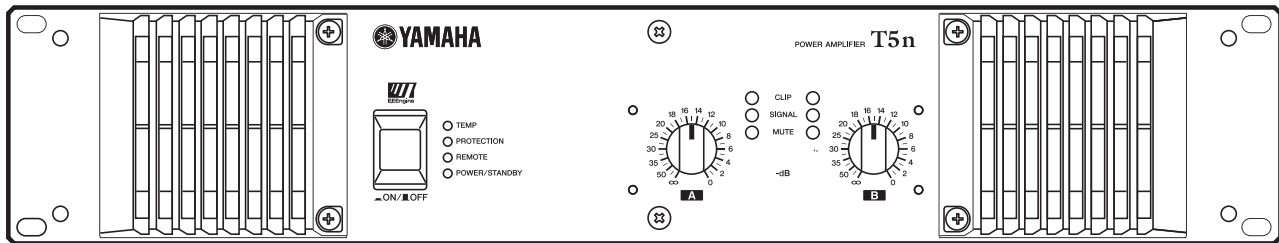

**Owner's Manual**  
**Bedienungsanleitung**  
**Mode d'emploi**  
**Manual de instrucciones**

**使用说明书**  
**取扱説明書**

English

Deutsch

Français

Español

中文

日本語

EN  
DE  
FR  
ES  
ZH  
JA

## FCC INFORMATION (U.S.A.)

### 1. IMPORTANT NOTICE: DO NOT MODIFY THIS UNIT!

This product, when installed as indicated in the instructions contained in this manual, meets FCC requirements. Modifications not expressly approved by Yamaha may void your authority, granted by the FCC, to use the product.

**2. IMPORTANT:** When connecting this product to accessories and/or another product use only high quality shielded cables. Cable/s supplied with this product **MUST** be used. Follow all installation instructions. Failure to follow instructions could void your FCC authorization to use this product in the USA.

**3. NOTE:** This product has been tested and found to comply with the requirements listed in FCC Regulations, Part 15 for Class "B" digital devices. Compliance with these requirements provides a reasonable level of assurance that your use of this product in a residential environment will not result in harmful interference with other electronic devices. This equipment generates/uses radio frequencies and, if not installed and used according to the instructions found in the users manual, may cause interference harmful to the operation of other electronic

devices. Compliance with FCC regulations does not guarantee that interference will not occur in all installations. If this product is found to be the source of interference, which can be determined by turning the unit "OFF" and "ON", please try to eliminate the problem by using one of the following measures:

Relocate either this product or the device that is being affected by the interference.

Utilize power outlets that are on different branch (circuit breaker or fuse) circuits or install AC line filter/s.

In the case of radio or TV interference, relocate/reorient the antenna. If the antenna lead-in is 300 ohm ribbon lead, change the lead-in to co-axial type cable.

If these corrective measures do not produce satisfactory results, please contact the local retailer authorized to distribute this type of product. If you can not locate the appropriate retailer, please contact Yamaha Corporation of America, Electronic Service Division, 6600 Orangethorpe Ave, Buena Park, CA90620

The above statements apply **ONLY** to those products distributed by Yamaha Corporation of America or its subsidiaries.

\* This applies only to products distributed by YAMAHA CORPORATION OF AMERICA.

(class B)



The above warning is located on the top of the unit.

### Explanation of Graphical Symbols

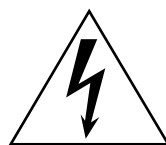

The lightning flash with arrowhead symbol within an equilateral triangle is intended to alert the user to the presence of uninsulated "dangerous voltage" within the product's enclosure that may be of sufficient magnitude to constitute a risk of electric shock to persons.



The exclamation point within an equilateral triangle is intended to alert the user to the presence of important operating and maintenance (servicing) instructions in the literature accompanying the product.

## IMPORTANT SAFETY INSTRUCTIONS

- 1 Read these instructions.
- 2 Keep these instructions.
- 3 Heed all warnings.
- 4 Follow all instructions.
- 5 Do not use this apparatus near water.
- 6 Clean only with dry cloth.
- 7 Do not block any ventilation openings. Install in accordance with the manufacturer's instructions.
- 8 Do not install near any heat sources such as radiators, heat registers, stoves, or other apparatus (including amplifiers) that produce heat.
- 9 Do not defeat the safety purpose of the polarized or grounding-type plug. A polarized plug has two blades with one wider than the other. A grounding type plug has two blades and a third grounding prong. The wide blade or the third prong are provided for your safety. If the provided plug does not fit into your outlet, consult an electrician for replacement of the obsolete outlet.
- 10 Protect the power cord from being walked on or pinched particularly at plugs, convenience receptacles, and the

- point where they exit from the apparatus.
- 11 Only use attachments/accessories specified by the manufacturer.
- 12 Use only with the cart, stand, tripod, bracket, or table specified by the manufacturer, or sold with the apparatus. When a cart is used, use caution when moving the cart/apparatus combination to avoid injury from tip-over.
- 13 Unplug this apparatus during lightning storms or when unused for long periods of time.
- 14 Refer all servicing to qualified service personnel. Servicing is required when the apparatus has been damaged in any way, such as power-supply cord or plug is damaged, liquid has been spilled or objects have fallen into the apparatus, the apparatus has been exposed to rain or moisture, does not operate normally, or has been dropped.



### WARNING

TO REDUCE THE RISK OF FIRE OR ELECTRIC SHOCK, DO NOT EXPOSE THIS APPARATUS TO RAIN OR MOISTURE.

(98-6500)

# PRECAUTIONS

## PLEASE READ CAREFULLY BEFORE PROCEEDING

\* Please keep this manual in a safe place for future reference.



### WARNING

Always follow the basic precautions listed below to avoid the possibility of serious injury or even death from electrical shock, short-circuiting, damages, fire or other hazards. These precautions include, but are not limited to, the following:

#### Power supply/Power cord

- Only use the voltage specified as correct for the device. The required voltage is printed on the name plate of the device.
- Do not place the power cord near heat sources such as heaters or radiators, and do not excessively bend or otherwise damage the cord, place heavy objects on it, or place it in a position where anyone could walk on, trip over, or roll anything over it.
- Be sure to connect to an appropriate outlet with a protective grounding connection. Improper grounding can result in electrical shock.

#### Do not open

- Do not open the device or attempt to disassemble the internal parts or modify them in any way. The device contains no user-serviceable parts. If it should appear to be malfunctioning, discontinue use immediately and have it inspected by qualified Yamaha service personnel.

#### Water warning

- Do not expose the device to rain, use it near water or in damp or wet conditions, or place containers on it containing liquids which might spill into any openings.
- Never insert or remove an electric plug with wet hands.

#### If you notice any abnormality

- If the power cord or plug becomes frayed or damaged, or if there is a sudden loss of sound during use of the device, or if any unusual smells or smoke should appear to be caused by it, immediately turn off the power switch, disconnect the electric plug from the outlet, and have the device inspected by qualified Yamaha service personnel.
- If this device should be dropped or damaged, immediately turn off the power switch, disconnect the electric plug from the outlet, and have the device inspected by qualified Yamaha service personnel.



### CAUTION

Always follow the basic precautions listed below to avoid the possibility of physical injury to you or others, or damage to the device or other property. These precautions include, but are not limited to, the following:

#### Power supply/Power cord

- Remove the electric plug from the outlet when the device is not to be used for extended periods of time, or during electrical storms.
- When removing the electric plug from the device or an outlet, always hold the plug itself and not the cord. Pulling by the cord can damage it.

#### Location

- Before moving the device, remove all connected cables.
- When setting up the device, make sure that the AC outlet you are using is easily accessible. If some trouble or malfunction occurs, immediately turn off the power switch and disconnect the plug from the outlet. Even when the power switch is turned off, electricity is still flowing to the product all the minimum level. When you are not using the product for a long time, make sure to unplug the power cord from the wall AC outlet.
- If this device is to be mounted in an EIA-standard rack, leave the back of the rack open and make sure that it is at least 10 cm away from walls or surfaces to provide better airflow. In such a situation, these devices can be stacked on top of each other if necessary. Also, if this device is to be mounted with devices that tend to generate heat, such as power amplifiers made by another manufacturer, be sure to keep an adequate gap between this device and the heat-generating devices, or install ventilation panels or forced ventilation fans to prevent high temperatures from developing inside this device. Inadequate ventilation can result in overheating, possibly causing damage to the device(s), or even fire.

- Do not use the device in a confined, poorly-ventilated location. If this device is to be used in a small space other than an EIA-standard rack, make sure that there is adequate space between the device and surrounding walls or other devices: at least 10cm at the sides, 30cm behind and 40cm above. Inadequate ventilation can result in overheating, possibly causing damage to the device(s), or even fire.
- Do not expose the device to excessive dust or vibrations, or extreme cold or heat (such as in direct sunlight, near a heater, or in a car during the day) to prevent the possibility of panel disfiguration or damage to the internal components.
- Do not place the device in an unstable position where it might accidentally fall over.
- Do not block the vents. This device has ventilation holes at the front/rear to prevent the internal temperature from becoming too high. In particular, do not place the device on its side or upside down. Inadequate ventilation can result in overheating, possibly causing damage to the device(s), or even fire.
- Do not use the device in the vicinity of a TV, radio, stereo equipment, mobile phone, or other electric devices. Doing so may result in noise, both in the device itself and in the TV or radio next to it.
- Do not place the device in a location where it may come into contact with corrosive gases or salt air. Doing so may result in malfunction.

## Connections

- Before connecting the device to other devices, turn off the power for all devices. Before turning the power on or off for all devices, set all volume levels to minimum.
- Use only speaker cables for connecting speakers to the speaker jacks. Use of other types of cables may result in fire.

## Maintenance

- Inspect the cooling fan air filter and clean it periodically (see page 11). Dust and dirt can seriously degrade the effectiveness of the cooling fan and result in malfunction or fire.
- Remove the power plug from the AC outlet when cleaning the device.

## Handling caution

- When turning on the AC power in your audio system, always turn on the device LAST, to avoid speaker damage. When turning the power off, the device should be turned off FIRST for the same reason.
- Do not insert your fingers or hands in any gaps or openings on the device (vents).
- Avoid inserting or dropping foreign objects (paper, plastic, metal, etc.) into any gaps or openings on the device (vents) If this happens, turn off the power immediately and unplug the power cord from the AC outlet. Then have the device inspected by qualified Yamaha service personnel.
- Do not use the device for a long period of time at a high or uncomfortable volume level, since this can cause permanent hearing loss. If you experience any hearing loss or ringing in the ears, consult a physician.
- Do not rest your weight on the device or place heavy objects on it, and avoid use excessive force on the buttons, switches or connectors.
- Do not use this device for any purpose other than driving loudspeakers.

XLR-type connectors are wired as follows (IEC60268 standard): pin 1: ground, pin 2: hot (+), and pin 3: cold (-).  
Use only Neutrik NL4 plugs for connecting Speakon connectors.

Yamaha cannot be held responsible for damage caused by improper use or modifications to the device, or data that is lost or destroyed.

Always turn the power off when the device is not in use.

The performance of components with moving contacts, such as switches, volume controls, and connectors, deteriorates over time. Consult qualified Yamaha service personnel about replacing defective components.

Illustrations in this manual are for explanatory purposes only, and may not match the actual appearance of the product during operation.

The company names and product names in this Owner's Manual are the trademarks or registered trademarks of their respective companies.

### IMPORTANT NOTICE FOR THE UNITED KINGDOM Connecting the Plug and Cord

#### WARNING: THIS APPARATUS MUST BE EARTHED

IMPORTANT. The wires in this mains lead are coloured in accordance with the following code:

GREEN-AND-YELLOW : EARTH  
BLUE : NEUTRAL  
BROWN : LIVE

As the colours of the wires in the mains lead of this apparatus may not correspond with the coloured markings identifying the terminals in your plug, proceed as follows:

The wire which is coloured GREEN-AND-YELLOW must be connected to the terminal in the plug which is marked by the letter E or by the safety earth symbol  or colored GREEN or GREEN-AND-YELLOW.

The wire which is coloured BLUE must be connected to the terminal which is marked with the letter N or coloured BLACK.

The wire which is coloured BROWN must be connected to the terminal which is marked with the letter L or coloured RED.

• This applies only to products distributed by Yamaha-Kemble Music (U.K.) Ltd. (3 wires)

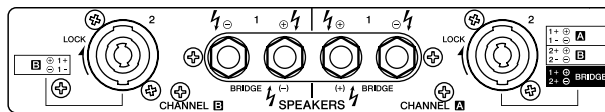

This lightning bolt mark indicates a dangerous electrically live terminal. When connecting an external wire to this terminal, it is necessary either to have "a person who have received appropriate guidance on handling" make the connection or to use leads or a cord that have been manufactured in such a way that the connection can be made simply and without problem.

# Introduction

---

Thank you for your purchase of the YAMAHA T5n, T4n, T3n Series Power Amplifier.

This series of power amplifiers was developed from Yamaha's wealth of experience in building PA equipment and its tradition of careful attention to every detail of circuit design. These power amplifiers feature high power — thanks to EEEngine (Energy Efficient Engine) technology — and superb quality together with superior reliability and stability, guaranteeing the highest possible audio performance.

## Features:

- Three modes are provided to support a broad range of applications: STEREO mode which can be driven by two independent sources, PARALLEL mode in which a monaural source drives both channels, and BRIDGE mode in which the two internal amps function as a single high-power mono amp.
- Balanced XLR connector and Euroblock connector inputs, and Speakon connector and five-way binding post outputs are provided.
- SIGNAL indicator, CLIP indicator and MUTE indicator and sophisticated dB step Volume control are provided for each channel.
- PROTECTION indicator that shows the state of various protection systems (power On/Off detection, output protection, DC detection), a TEMP indicator that indicates heat sink overheating, and a POWER/STANBY indicator that indicates the power status are provided.
- Variable-speed low-noise fans ensure high reliability.
- The T5n enables parallel connection of multiple high-impedance speakers that support 100 V line output.
- The T3n enables parallel connection of multiple high-impedance speakers that support 70 V line output.
- An optional external amp control device, such as the ACD1 or ACU16-C, enables you to monitor or control the amplifier via a network. For the latest information about amp control units, please visit our website:  
<http://www.yamahaproaudio.com/>

This Owner's Manual applies to the three models: T5n, T4n and T3n power amplifiers.

Please read through this manual carefully before beginning use, so that you will be able to take full advantage of your power amp's superlative features and enjoy trouble-free operation for years to come.

## Accessories

- Owner's Manual
- Two handles
- Four flat-head screws
- Two Euroblock connectors

## Index

---

<b>Controls and Functions</b> .....	<b>6</b>
Front Panel .....	6
Rear Panel .....	7
<b>Speaker Connections</b> .....	<b>8</b>
STEREO Mode .....	8
PARALLEL Mode .....	8
BRIDGE Mode .....	9
<b>Wiring</b> .....	<b>9</b>
Using a Euroblock connector .....	9
Speaker Connection .....	10
<b>Filter Element Cleaning</b> .....	<b>11</b>
<b>Troubleshooting</b> .....	<b>11</b>
<b>Specifications</b> .....	<b>12</b>
<b>Block Diagram</b> .....	<b>71</b>
<b>Dimensions</b> .....	<b>72</b>
<b>Performance Graph</b> .....	<b>73</b>
<b>Current Draw</b> .....	<b>73</b>

# Controls and Functions

## ■ Front Panel

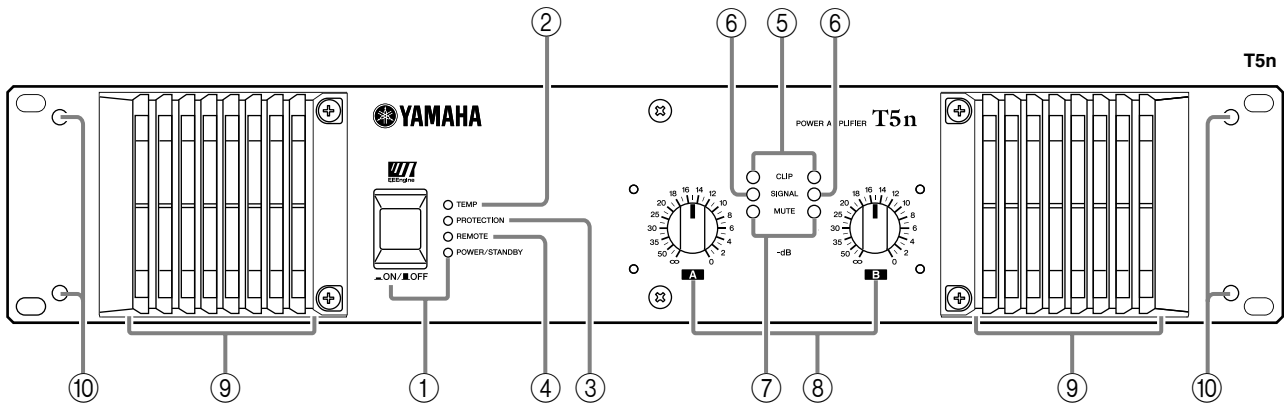

### ① POWER switch and indicator

Press to toggle the power on or off. The POWER indicator lights up green when the power is ON.

If the amplifier is connected to an amp control device such as the ACD1 or ACU16-C and the amplifier has been commanded to enter STANDBY mode, this indicator will light orange.

### ② TEMP indicator

Lights up red if the heat sink temperature exceeds 85°C (185°F).

### ③ PROTECTION indicator

When the protection system is active, the indicator lights in red. No sound will be output from the speakers, since the speakers are automatically disconnected from the amplifier's outputs.

The protection system activates in the following situations:

- **When the amplifier is turned on**

The protection system activates for approximately 10 seconds when the amplifier is turned on. After 10 seconds, the protection system deactivates automatically and the amplifier is ready for normal operation.

- **If the amplifier overheats**

The protection system activates if the heat sink temperature exceeds 85°C (185°F). The amplifier is muted if the heat sink temperature exceeds 90°C (194°F). The amplifier operates normally after the amplifier cools down.

### ④ REMOTE indicator

This indicator will light green if the amplifier is being controlled by an amp control device such as the ACD1 or ACU16-C.

### ⑤ CLIP indicator

Lights up red when the output signal distortion on the corresponding channel rises above 1% — indicating that “clipping” has occurred because the signal level is too high.

### ⑥ SIGNAL indicator

Lights up green when the corresponding channel's output level exceeds 1 Vrms (equivalent to 0.2 W into an 8 ohms load, 0.4 W into a 4 ohms load or 0.8 W into a 2 ohms load).

### ⑦ MUTE indicator

This indicator will light red if the amplifier is muted by an amp control device such as the ACD1 or ACU16-C. This indicator will also light red while the PROTECTION indicator is ON.

### ⑧ Volume control knobs

Each control knob adjusts the volume of the corresponding channel, in 31 steps from -∞ dB to 0 dB.

#### Note: Screw holes for security cover

These four screw holes are for attaching a security cover to protect the volume setting. Since a security cover and screws are not included in the amplifier, please prepare a security cover the same size as indicated below and four M3 screws.

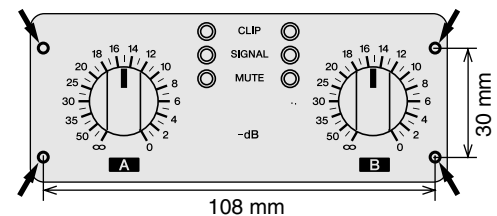

### ⑨ Air intakes

The amplifier uses forced-air cooling. The variable speed cooling fan draws air in from the front and exhausts it through the rear. The cooling fan speed varies depending on the heat sink temperature: It operates at low speed when it is below 40 °C (104 °F), increases in speed according to increases in temperature, and operates at high speed when temperature exceeds 60 °C (140 °F). Please be sure that you do not block the air intakes or exhaust vents. Also, clean the filter elements regularly. If the air intakes are clogged with dust or debris, the amplifier will overheat, which may result in the amplifier to shutting down.

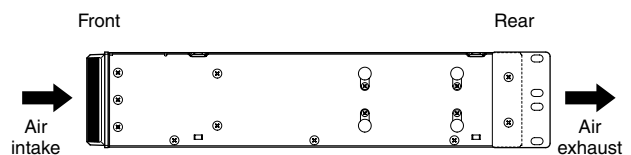

### ⑩ Screw holes for handles

These four screw holes are for the included handles. Fix the handles to the amplifier, using the included flat-head screws.

■ Rear Panel

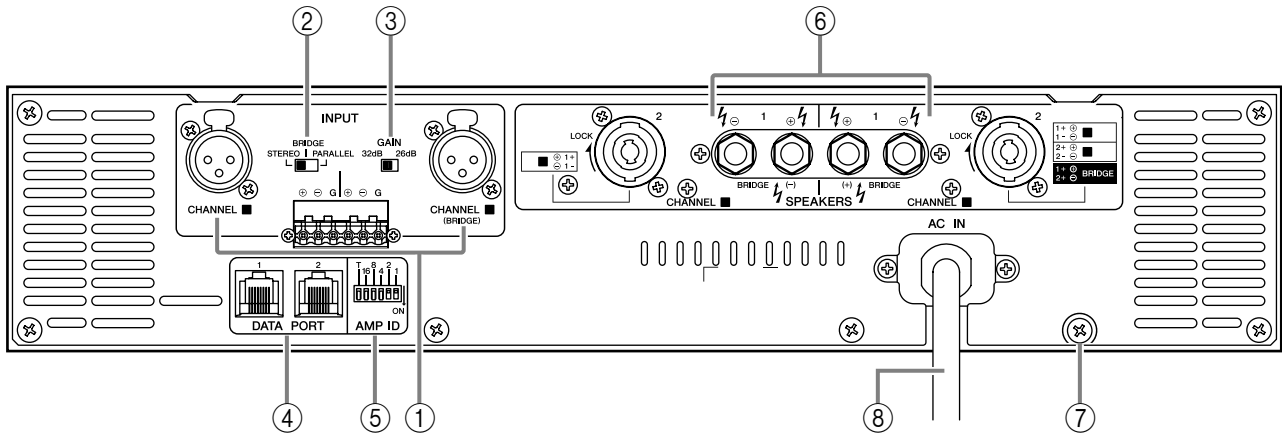

① Input connectors

• XLR3-31 type input connectors

The pins are wired as shown below (IEC 60268).

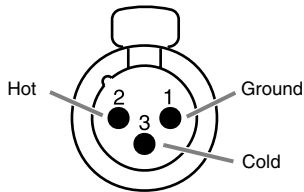

• Euroblock input connectors

These are balanced input connectors. The included Euroblock connectors can be used to make connections here.

**Note:** In PARALLEL and BRIDGE mode, only the channel A connector is active. Make sure not to input an audio signal to an inactive input terminal (channel B).

② Mode switch

• STEREO mode

In STEREO mode, channels A and B are completely independent.

• PARALLEL mode

In PARALLEL mode, the channel A input signal is sent both to the channel A power amp and the channel B amp. The Channel B input connector does not function.

• BRIDGE mode

In BRIDGE mode, channels A and B operates simultaneously, functioning as a single mono amplifier.

③ GAIN switch

This switch is used when changing the Gain of the A and B channels simultaneously.

32 dB: Setting of 32 dB

26 dB: Setting of 26 dB

When monitoring or controlling from an amplifier control device such as the ACD1 or ACU16-C, set the GAIN switch to [26 dB] to avoid clipping if you plan to input signals with a maximum input level of +24 dBu.

When the power amplifier is connected to the ACD1 or ACU16-C, the electronic volume control inside the amplifier will become effective, and the maximum input level will become +18 dBu if the GAIN switch has been set to [32 dB].

④ DATA PORT jacks

An amp control device, such as the ACD1 or ACU16-C, can be connected to the DATA PORT jack for monitoring or controlling the amplifier from the external device.

⑤ AMP ID switch

When an amp control device, such as the ACD1 or ACU16-C, is connected to the DATA PORT jack ④, the AMP ID can be used to set the amplifier's ID.

⑥ SPEAKERS jacks

• 5-way binding post output jacks

• Speakon type output jacks

Speakon type cable plugs (Neutrik NL4) can be connected here.

⑦ Ground screw

If you are having a problem with hum or noise, use this terminal to connect to ground or connect to the chassis of the mixer, preamp, or other device in your system.

⑧ AC IN connector

Amplifiers purchased in the United States of America and Canada.

This amplifier uses a NEMA L5-30 outlet.

Connect the 30 A twist-lock connectors by orienting the locking L-shaped prong with the corresponding connector entry, then fully insert the three prongs. Twist the plug about 1/8 of a turn clockwise to lock the connector and plug.

**CAUTION**

The amplifier requires very high-power so that it can demand high current from the AC service. Connections must be properly rated for reliable operation.

**CAUTION**

If this device is to be rack mounted and transported frequently, be sure to support the rear end of the unit with mounting hardware that matches the size of the rack used.

# Speaker Connections

Speakers can be connected to the amplifier as shown below. Note that actual speaker impedance varies according to the connection method and the number of speakers. Please be sure that your speakers' impedance is not less than the relevant minimum value indicated below.

## ■ STEREO Mode

Set the MODE switch on the rear panel to "STEREO" to use the unit as a stereo amplifier. The volume controls on the front panel (A and B) let you control the volume of each channel independently.

### ● 5-way binding post

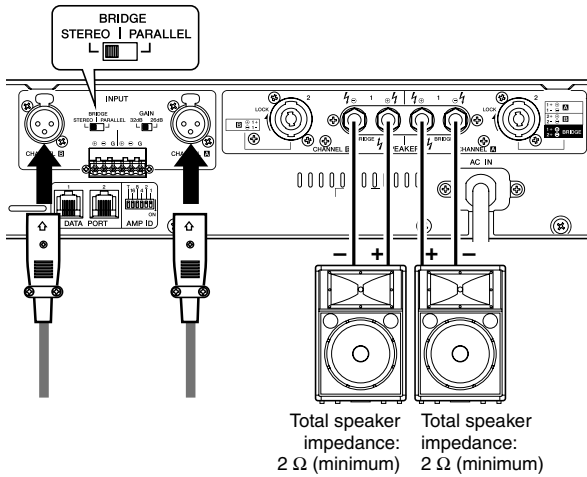

### ● Speakon connector

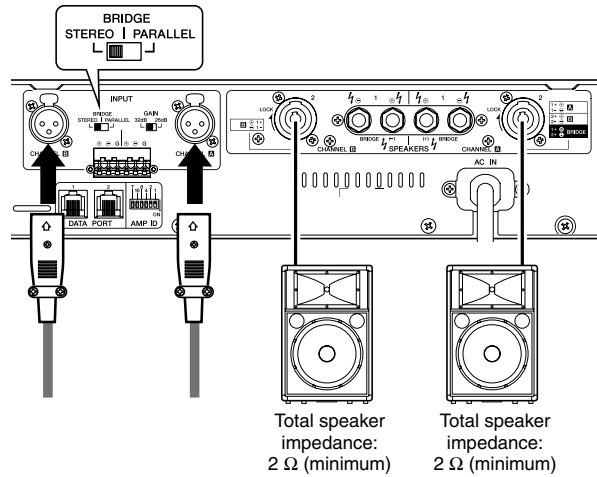



## ■ BRIDGE Mode (use as high-power mono amplifier)

Set the MODE switch on the rear panel to “BRIDGE” to use the unit as a high-power mono amplifier. The volume control A on the front panel lets you control the volume.

### ● 5-way binding post

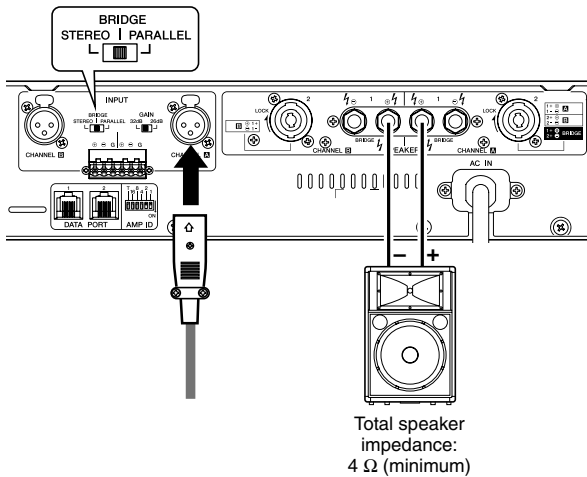

### ● Speakon connector

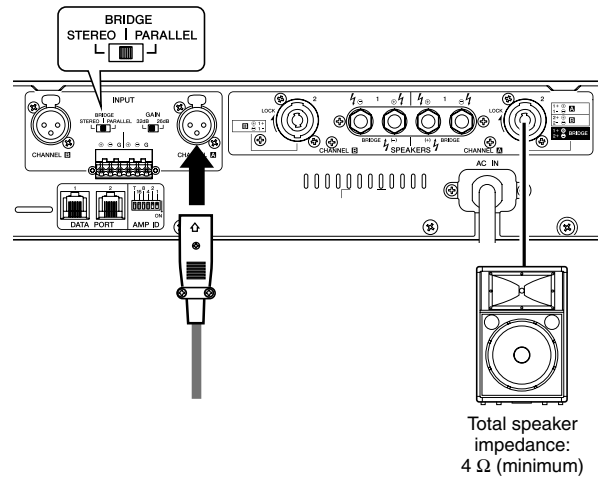

## Wiring

Turn off the POWER switch before connecting external devices to the amplifier.

## ■ Using a Euroblock connector

### ● Cable preparation

- To prepare the cable for attachment to a Euroblock connector, strip the wire as shown in the illustration, and use stranded wire to make connections. With a Euroblock connection, the stranded wire may be prone to breakage because of metal fatigue due to the weight of the cable or due to vibration. When rack-mounting your equipment, use a lacing bar when possible to bundle and fasten the cables.

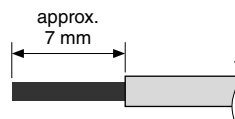

- If cables will be frequently connected and disconnected, as in the case of a portable installation, we recommend that you use ferrules with insulation sleeves. Use a ferrule whose conductor portion has an external diameter of 1.6 mm or less, and a length of approximately 7 mm (such as the AI0, 5-6WH made by the Phoenix Contact corporation).

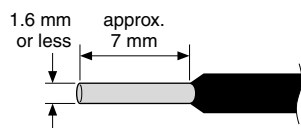

### ⚠ CAUTION

If you use stranded wire, do not tin (plate with solder) the exposed end.

1. If the wire insertion ports are closed, turn the screws on top of the connector counterclockwise to open the ports.
2. Insert the wires into the appropriate ports, following the indication of the pole on the input terminal, and turn the screws on top of the connector clockwise to fix the wires.
3. Attach the Euroblock connector to the input terminal on the amplifier.

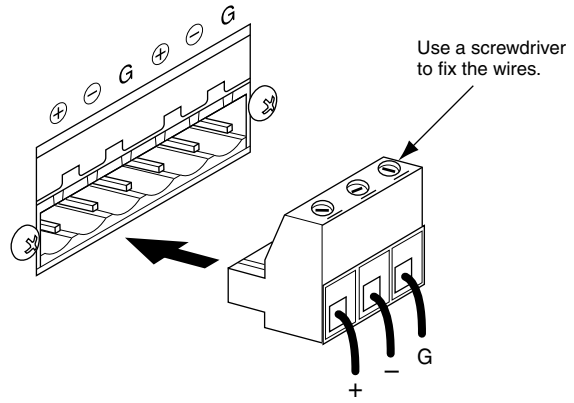

## ■ Speaker Connection

### ● 5-way binding post

1. Remove the cover attachment screws and remove the protective cover from the speaker terminals.
2. Remove about 15mm of insulation from the end of each speaker cable, and pass the bare wire through the holes in the appropriate speaker terminals. Tighten the terminals to securely clamp the wires. Refer to page 8 for speaker polarities. Be sure that the bare wire ends do not jut out from the terminals and touch the chassis. The illustration on the right shows how the cable should look when correctly attached.
3. Reattach the protective cover over the speaker terminals.

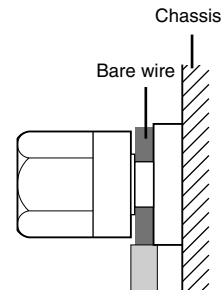
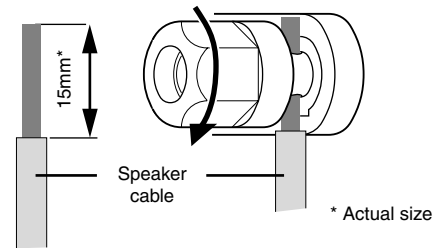
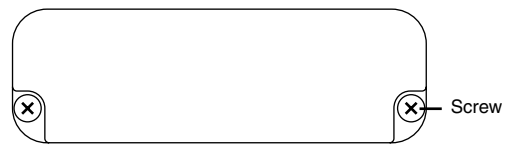

### ● Speakon connector

Insert the Neutrik NL4 plugs into the Speakon connector on the rear of the amplifier, and turn clockwise to lock.

CHANNEL **A**  
STEREO or PARALLEL

Neutrik	Amplifier
1+	A+
1-	A-
2+	B+
2-	B-

BRIDGE

Neutrik	Amplifier
1+	+
1-	
2+	-
2-	

Neutrik NL4 plugs

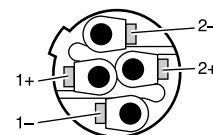

CHANNEL **B**

Neutrik	Amplifier
1+	B+
1-	B-

# Filter Element Cleaning

To ensure adequate cooling air intake, the filter elements must be cleaned when they have become clogged. Follow the description below to clean the filter elements.

1. Make sure that the power to the amplifier is turned off.
2. Disconnect the power plug from the AC outlet.
3. Remove the two screws that secure the front filter grilles to the amplifier.
4. Remove the filter elements, and wash them in plain water. If the filter elements are exceptionally dirty, mild detergent may be used.
5. Dry the filter elements completely.

**⚠ CAUTION**

**Never replace the filter elements while they are still wet.**

6. Replace the filter elements on the air intakes, hook the front filter grilles on the amplifier, and secure them using the screws. (The replacement part number of the filter element is WH66270.)

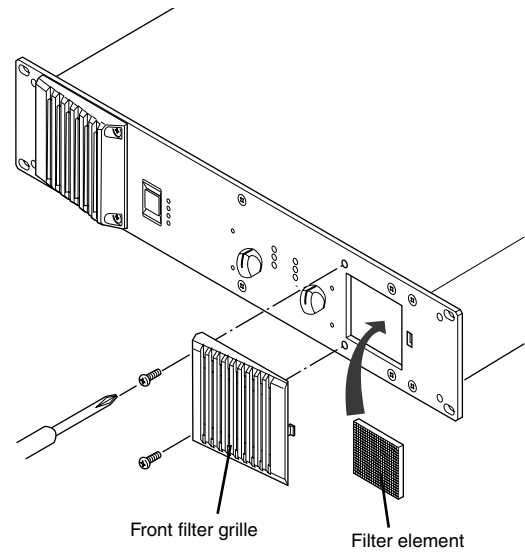

# Troubleshooting

The following table lists the main causes of abnormal operation and the corrective measures required, as well as the protective circuit operation in each case.

Indicator(s)	Possible Cause	Remedy	Protection Circuit
CLIP indicator lights.	There is a short at a speaker terminal, amplifier terminal, or wire.	Locate and correct the cause of the short.	The PC limiter circuit operates to protect the power transistors.
	The amplifier load is excessive.	Use a speaker system with an impedance of at least 2 ohms (STEREO/PARALLEL mode) or 4 ohms (BRIDGE mode).	
TEMP indicator lights.	The heat sink temperature has exceeded 85°C.	Check the ventilation slots and clean the filter elements to provide better airflow around the amplifier.	The TEMP indicator lights up to indicate temperature warning.
PROTECTION indicator lights.	The heat sink temperature has exceeded 85°C.	Check the amplifier ventilation conditions and take appropriate measures to improve the airflow around the amplifier. Also, clean the filter elements to ensure proper airflow.	The thermal protection circuit operates to protect the power transistors.
	A DC voltage is detected at the amplifier's output.	Consult your dealer or the nearest Yamaha service center.	The power supply shuts down to protect the speaker system.
MUTE indicator lights.	There is a short at a speaker terminal.	Locate and correct the cause of the short.	The MUTE circuit operates to protect the power transistors.

# Specifications

T5n				120V	230V	240V
Output Power	1 kHz THD + N = 1%	8 Ω per channel	MIN	1350 W	1350 W	1400 W
		4 Ω per channel		2200 W	2350 W	2500 W
		2 Ω per channel		2500 W	2500 W	2500 W
		8 Ω bridge		4400 W	4700 W	5000 W
		4 Ω bridge		5000 W	5000 W	5000 W
	20 ms burst	2 Ω per channel		3400 W	3400 W	3600 W
		4 Ω bridge		6800 W	6800 W	7200 W
Constant voltage line			STEREO mode: 100 V line, 1250 W/8 Ω BRIDGE mode: 200 V line, 2500 W/16 Ω			
Input Sensitivity RL=8 Ω	26 dB position		+16.6 dBu	+16.6 dBu	+16.7 dBu	
	32 dB position		+10.6 dBu	+10.6 dBu	+10.7 dBu	
SN Ratio	20 Hz-20 kHz	(DIN AUDIO)	MIN	107 dB		
Power Consumption	Standby			5 W		
	Idle			70 W		
	1/8 power, 2 Ω/pink noise			1600 W		
T4n				120V	230V	240V
Output Power	1 kHz THD + N = 1%	8 Ω per channel	MIN	1150 W	1150 W	1250 W
		4 Ω per channel		1950 W	2050 W	2150 W
		2 Ω per channel		2200 W	2200 W	2200 W
		8 Ω bridge		3900 W	4100 W	4300 W
		4 Ω bridge		4400 W	4400 W	4400 W
	20 ms burst	2 Ω per channel		2900 W	3100 W	3300 W
		4 Ω bridge		5800 W	6200 W	6600 W
Constant voltage line			—			
Input Sensitivity RL=8 Ω	26 dB position		+15.9 dBu	+15.9 dBu	+16.2 dBu	
	32 dB position		+9.9 dBu	+ 9.9 dBu	+10.2 dBu	
SN Ratio	20 Hz-20 kHz	(DIN AUDIO)	MIN	106 dB		
Power Consumption	Standby			5 W		
	Idle			70 W		
	1/8 power, 2 Ω/pink noise			1400 W		
T3n				120V	230V	240V
Output Power	1 kHz THD + N = 1%	8 Ω per channel	MIN	790 W	750 W	850 W
		4 Ω per channel		1400 W	1400 W	1500 W
		2 Ω per channel		1900 W	1900 W	1900 W
		8 Ω bridge		2800 W	2800 W	3000 W
		4 Ω bridge		3800 W	3800 W	3800 W
	20 ms burst	2 Ω per channel		2200 W	2150 W	2350 W
		4 Ω bridge		4400 W	4300 W	4700 W
Constant voltage line			TYP	STEREO mode: 70.7 V line, 625 W/8 Ω BRIDGE mode: 141.4 V line, 1250 W/16 Ω		
Input Sensitivity RL=8 Ω	26 dB position		+14.2 dBu	+14.0 dBu	+14.5 dBu	
	32 dB position		+8.2 dBu	+8.0 dBu	+8.5 dBu	
SN Ratio	20 Hz-20 kHz	(DIN AUDIO)	MIN	105 dB		
Power Consumption	Standby			5 W		
	Idle			70 W		
	1/8 power, 2 Ω/pink noise			1200 W		

All Models			
<b>THD + N</b>	20 Hz-20 kHz, Half power, RL = 4 Ω, 8 Ω	MAX	0.1 %
<b>Intermodulation Distortion</b>	60 Hz:7 kHz, 4:1, Half power	MAX	0.1 %
<b>Frequency Response</b>	RL = 8 Ω, Po = 1 W 20 Hz-20 kHz	MAX	0 dB
		TYP	0 dB
		MIN	-0.5 dB
<b>Channel Separation</b>	Half power, RL = 8 Ω, 1 kHz Att. Max, input 600 Ω shunt	MIN	67 dB
<b>Damping Factor</b>	RL = 8 Ω, 1 kHz	MIN	800
<b>Voltage Gain</b>	Att. Max	TYP	32 dB/26 dB
<b>Maximum Input Voltage</b>		MIN	+24 dBu
<b>Input Impedance</b>		TYP	20 kΩ (balanced) 10 kΩ (unbalanced)
<b>Controls</b>	Front Panel	POWER switch (ON/OFF)	
		Attenuator (31 position) x 2	
	Rear Panel	MODE switch (STEREO/BRIDGE/PARALLEL) x 1	
		GAIN switch (32 dB/26 dB) x 1	
		AMP ID switch (6P DIP) x 1	
<b>Connectors</b>	Input	XLR-3-31 type x 2 Euroblock connector (balanced) x 2	
	Output	Speakon x 2, 5-way binding post x 2 pairs	
	DATA PORT	RJ45 x 2	
<b>Indicators</b>	POWER/STANDBY	x 1 (Green/Orange)	
	REMOTE	x 1 (Green)	
	PROTECTION	x 1 (Red)	
	TEMP	x 1 (Red) heatsink temp ≥ 85 °C	
	SIGNAL	x 2 (Green)	
	MUTE	x 2 (Red)	
	CLIP	x 2 (Red)	
<b>Load Protection</b>	POWER switch ON/OFF mute		
	DC-fault: Amplifier shuts down automatically.		
	Clip limiting: THD ≥ 0.5 %		
<b>Amplifier Protection</b>	Thermal: Mute the output (heatsink temp ≥ 90 °C) (return automatically.)		
	VI limiter (RL ≤ 1 Ω): Limit the output.		
<b>Power Supply Protection</b>	Thermal: Amplifier shuts down automatically. (heatsink temp ≥ 100 °C)		
<b>Cooling</b>	Continuously variable-speed fan x 2		
<b>Power Requirements</b>	120V, 220V–240V; 50Hz/60Hz (120V models use 30A twist lock connector)		
<b>Power Cord Length</b>	1.5 m		
<b>Dimensions (W x H x D)</b>	480 x 88 x 447 mm (18-7/8" x 3-7/16" x 17-9/16")		
<b>Weight</b>	14.0 kg (30.9 lbs)		
<b>Included Accessories</b>	Handle x 2 (with flat-head screw x 4), Euroblock connector x 2, Owner's Manual		

These specifications apply to rated power supplies of 120 V, 230 V and 240 V.

Half Power = 3 dB below rated power

1/8 Power = 9 dB below rated power

0 dBu = 0.775 Vrms

Specifications and descriptions in this owner's manual are for information purposes only.

Yamaha Corp. reserves the right to change or modify products of specifications at any time without prior notice. Since specifications, equipment or options may not be the same in every locale, please check with your Yamaha dealer.

European models

Purchaser/User Information specified in EN55103-1 and EN55103-2.

Inrush Current: 14A

Conforms to Environments: E1, E2, E3, E4

# Block Diagram

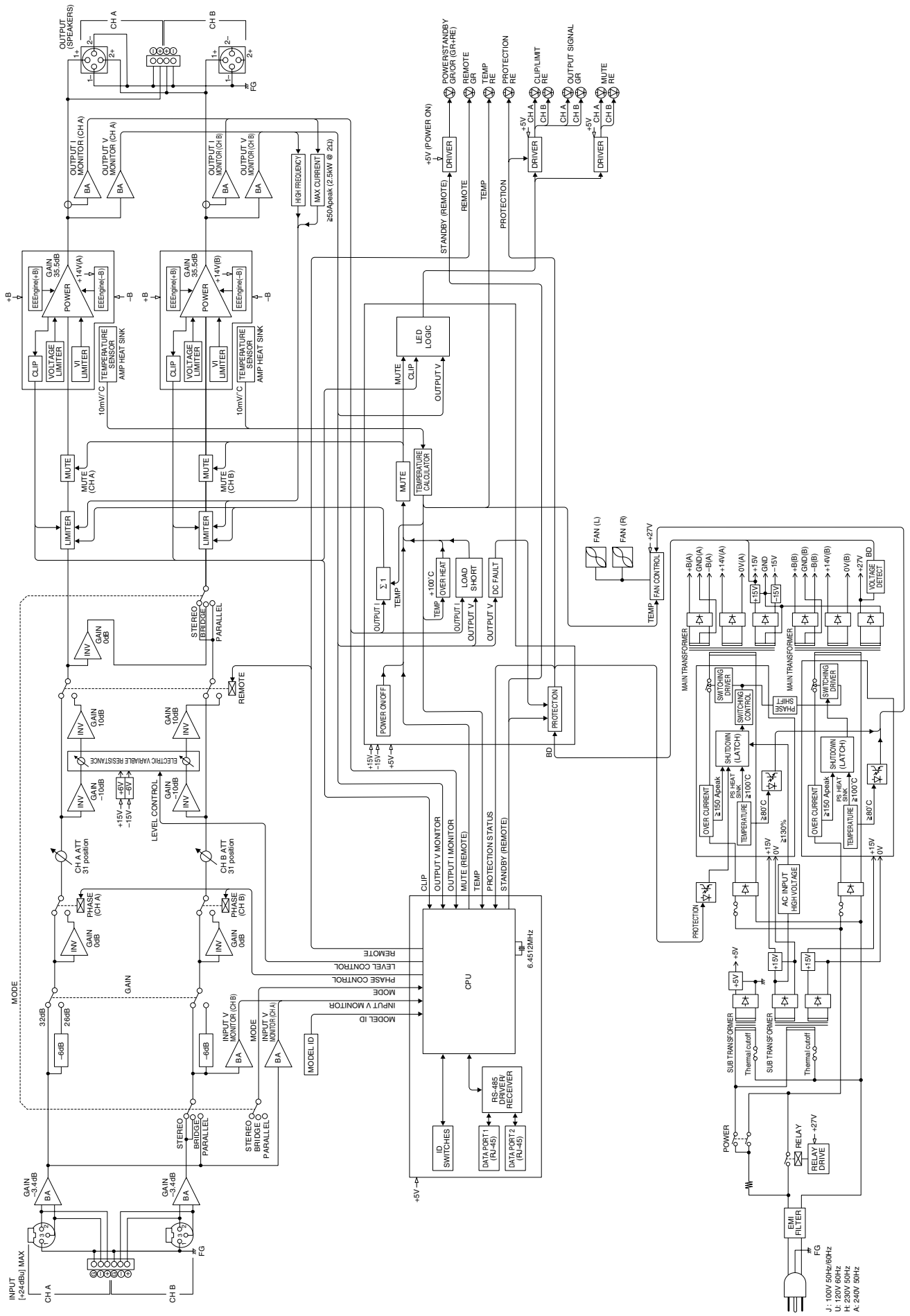

# Dimensions

Unit: mm

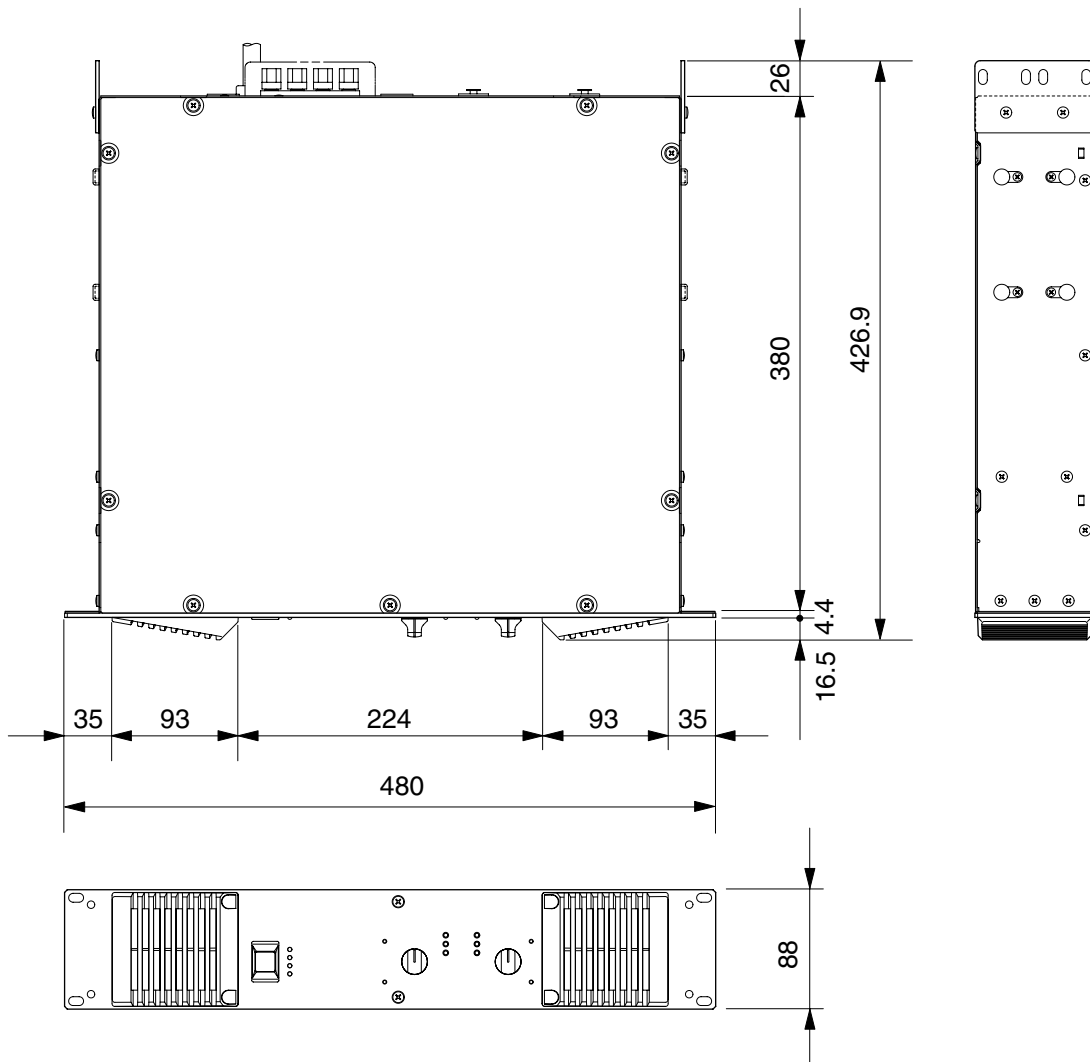

# Performance Graph

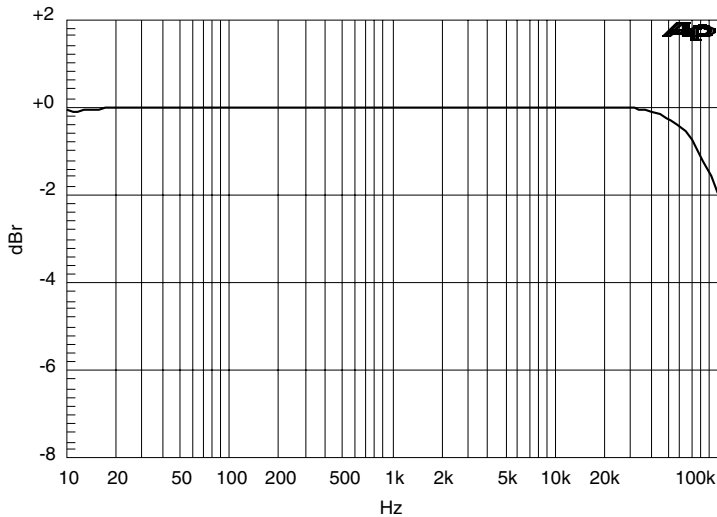

FREQUENCY RESPONSE  
 INPUT: Ch A/B (XLR 150 ohm)  
 OUTPUT: Ch A/B (8 ohm) 0 dB = 1 W  
 ATT: MAX

## Current Draw

### T5n

	Line Current (A)		Power (W)			Thermal Dissipation		
	100 V/120 V	230 V/240 V	In	Out	Dissipated	Btu/h	kcal/h	
standby	0.08	0.04	5	0	5	17	4	
idle	1.0	0.5	70	0	70	239	60	
1/8 power	8 Ω/ch	10.4	5.7	637	325	312	1070	269
	4 Ω/ch	14.7	8.1	955	525	430	1470	369
	2 Ω/ch	20.0	11.0	1302	625	677	2310	582
1/3 power	8 Ω/ch	20.6	11.3	1398	867	531	1810	457
	4 Ω/ch	30.9	17.0	2222	1400	822	2810	707
	2 Ω/ch	40.6	22.3	2924	1667	1257	4290	1080

### T4n

	Line Current (A)		Power (W)			Thermal Dissipation		
	100 V/120 V	230 V/240 V	In	Out	Dissipated	Btu/h	kcal/h	
standby	0.08	0.04	5	0	5	17	4	
idle	1.0	0.5	70	0	70	239	60	
1/8 power	8 Ω/ch	8.4	4.6	515	263	252	861	217
	4 Ω/ch	12.2	6.7	795	438	358	1220	308
	2 Ω/ch	17.6	9.7	1146	550	596	2030	512
1/3 power	8 Ω/ch	16.6	9.1	1129	700	429	1460	369
	4 Ω/ch	25.7	14.1	1852	1167	685	2340	589
	2 Ω/ch	35.7	19.6	2573	1467	1106	3780	952

### T3n

	Line Current (A)		Power (W)			Thermal Dissipation		
	100 V/120 V	230 V/240 V	In	Out	Dissipated	Btu/h	kcal/h	
standby	0.08	0.04	5	0	5	17	4	
idle	1.0	0.5	70	0	70	239	60	
1/8 power	8 Ω/ch	6.0	3.3	368	188	180	615	155
	4 Ω/ch	9.1	5.0	591	325	266	907	229
	2 Ω/ch	15.2	8.4	990	475	515	1760	443
1/3 power	8 Ω/ch	11.9	6.5	806	500	306	1050	264
	4 Ω/ch	19.1	10.5	1376	867	509	1740	438
	2 Ω/ch	30.9	17.0	2222	1267	956	3260	822

1/8 power is typical of program material with occasional clipping. Refer to these figures for most applications.

1/3 power represents program material with extremely heavy clipping.

Test signal: Pink Noise, bandwidth limited from 22Hz to 22kHz

1W = 0.860kcal/h, 1BTU = 0.252kcal

Note that Line Voltage [V] x Line Current [A] = [VA], not equals to [W].

Inrush current: 6A (100V), 7A (120V), 14A (240V)



For details of products, please contact your nearest Yamaha representative or the authorized distributor listed below.

Pour plus de détails sur les produits, veuillez-vous adresser à Yamaha ou au distributeur le plus proche de vous figurant dans la liste suivante.

Die Einzelheiten zu Produkten sind bei Ihrer unten aufgeführten Niederlassung und bei Yamaha Vertragshändlern in den jeweiligen Bestimmungsländern erhältlich.

Para detalles sobre productos, contacte su tienda Yamaha más cercana o el distribuidor autorizado que se lista debajo.

## NORTH AMERICA

### CANADA

**Yamaha Canada Music Ltd.**  
135 Milner Avenue, Scarborough, Ontario,  
M1S 3R1, Canada  
Tel: 416-298-1311

### U.S.A.

**Yamaha Corporation of America**  
6600 Orangethorpe Ave., Buena Park, Calif. 90620,  
U.S.A.  
Tel: 714-522-9011

## CENTRAL & SOUTH AMERICA

### MEXICO

**Yamaha De México, S.A. de C.V.**  
Av. Insurgentes Sur 1647 "Prisma Insurgentes",  
Col. San José Insurgentes, Del. Benito Juárez,  
03900, México, D.F.  
Tel: 55-5804-0600

### BRAZIL

**Yamaha Musical do Brasil Ltda.**  
Rua Joaquim Floriano, 913 - 4º andar, Itaim Bibi,  
CEP 04534-013 Sao Paulo, SP. BRAZIL  
Tel: 011-3704-1377

### ARGENTINA

**Yamaha Music Latin America, S.A.**  
**Sucursal de Argentina**  
Olga Cossettini 1553, Piso 4 Norte  
Madero Este-C1107CEK  
Buenos Aires, Argentina  
Tel: 011-4119-7000

### PANAMA AND OTHER LATIN AMERICAN COUNTRIES/ CARIBBEAN COUNTRIES

**Yamaha Music Latin America, S.A.**  
Torre Banco General, Piso 7, Urbanización Marbella,  
Calle 47 y Aquilino de la Guardia,  
Ciudad de Panamá, Panamá  
Tel: +507-269-5311

## EUROPE

### THE UNITED KINGDOM/IRELAND

**Yamaha Music Europe GmbH (UK)**  
Sherbourne Drive, Tilbrook, Milton Keynes,  
MK7 8BL, England  
Tel: 01908-366700

### GERMANY

**Yamaha Music Europe GmbH**  
Siemensstraße 22-34, 25462 Rellingen, Germany  
Tel: 04101-3030

### SWITZERLAND/LIECHTENSTEIN

**Yamaha Music Europe GmbH**  
**Branch Switzerland in Zürich**  
Seefeldstrasse 94, 8008 Zürich, Switzerland  
Tel: 044-387-8080

### AUSTRIA/BULGARIA

**Yamaha Music Europe GmbH Branch Austria**  
Schleiergasse 20, A-1100 Wien, Austria  
Tel: 01-60203900

### CZECH REPUBLIC/HUNGARY/ ROMANIA/SLOVAKIA/SLOVENIA

**Yamaha Music Europe GmbH**  
**Branch Austria (Central Eastern Europe Office)**  
Schleiergasse 20, A-1100 Wien, Austria  
Tel: 01-602039025

### POLAND/LITHUANIA/LATVIA/ESTONIA

**Yamaha Music Europe GmbH**  
**Branch Poland Office**  
ul. Wrotkowa 14 02-553 Warsaw, Poland  
Tel: 022-500-2925

### MALTA

**Olimpus Music Ltd.**  
The Emporium, Level 3, St. Louis Street Msida  
MSD06  
Tel: 02133-2144

### THE NETHERLANDS/ BELGIUM/LUXEMBOURG

**Yamaha Music Europe Branch Benelux**  
Clarissenhof 5-b, 4133 AB Vianen, The Netherlands  
Tel: 0347-358 040

### FRANCE

**Yamaha Music Europe**  
7 rue Ambroise Croizat, Zone d'activités Pariest,  
77183 Croissy-Beaubourg, France  
Tel: 01-64-61-4000

### ITALY

**Yamaha Music Europe GmbH, Branch Italy**  
Viale Italia 88, 20020 Lainate (Milano), Italy  
Tel: 02-935-771

### SPAIN/PORTUGAL

**Yamaha Music Europe GmbH Ibérica, Sucursal en España**  
Ctra. de la Coruna km. 17, 200, 28230  
Las Rozas (Madrid), Spain  
Tel: +34-902-39-8888

### GREECE

**Philippos Nakas S.A. The Music House**  
147 Skiathou Street, 112-55 Athens, Greece  
Tel: 01-228 2160

### SWEDEN/FINLAND/ICELAND

**Yamaha Music Europe GmbH Germany filial Scandinavia**  
J. A. Wettergrens Gata 1, Box 30053  
S-400 43 Göteborg, Sweden  
Tel: 031 89 34 00

### DENMARK

**Yamaha Music Europe GmbH, Tyskland – filial Denmark**  
Generatorvej 6A, DK-2730 Herlev, Denmark  
Tel: 44 92 49 00

### NORWAY

**Yamaha Music Europe GmbH Germany - Norwegian Branch**  
Grini Næringspark 1, N-1345 Østerås, Norway  
Tel: 67 16 77 70

### RUSSIA

**Yamaha Music (Russia)**  
Room 37, bld. 7, Kievskaya street, Moscow,  
121059, Russia  
Tel: 495 626 5005

### OTHER EUROPEAN COUNTRIES

**Yamaha Music Europe GmbH**  
Siemensstraße 22-34, 25462 Rellingen, Germany  
Tel: +49-4101-3030

## AFRICA

**Yamaha Corporation,**  
**Asia-Pacific Sales & Marketing Group**  
Nakazawa-cho 10-1, Naka-ku, Hamamatsu,  
Japan 430-8650  
Tel: +81-53-460-2303

## MIDDLE EAST

### TURKEY

**Yamaha Music Europe GmbH**  
**Merkezi Almanya Türkiye İstanbul Şubesi**  
Maslak Meydan Sokak No:5 Spring Giz Plaza  
Bağimsız Bol. No:3, 34398 Şişli İstanbul  
Tel: +90-212-999-8010

### CYPRUS

**Yamaha Music Europe GmbH**  
Siemensstraße 22-34, 25462 Rellingen, Germany  
Tel: 04101-3030

### OTHER COUNTRIES

**Yamaha Music Gulf FZE**  
LOB 16-513, P.O.Box 17328, Jubel Ali,  
Dubai, United Arab Emirates  
Tel: +971-4-881-5868

## ASIA

### THE PEOPLE'S REPUBLIC OF CHINA

**Yamaha Music & Electronics (China) Co., Ltd.**  
2F, Yunhedasha, 1818 Xinzha-lu, Jingan-qu,  
Shanghai, China  
Tel: 021-6247-2211

### INDIA

**Yamaha Music India Pvt. Ltd.**  
Spazedge building, Ground Floor, Tower A, Sector  
47, Gurgaon- Sohna Road, Gurgaon, Haryana, India  
Tel: 0124-485-3300

### INDONESIA

**PT. Yamaha Musik Indonesia (Distributor)**  
**PT. Nusantik**  
Gedung Yamaha Music Center, Jalan Jend. Gatot  
Subroto Kav. 4, Jakarta 12930, Indonesia  
Tel: 021-520-2577

### KOREA

**Yamaha Music Korea Ltd.**  
8F, 9F, Dongsung Bldg. 158-9 Samsung-Dong,  
Kangnam-Gu, Seoul, Korea  
Tel: 02-3467-3300

### MALAYSIA

**Yamaha Music (Malaysia) Sdn., Bhd.**  
Lot 8, Jalan Perbandaran, 47301 Kelana Jaya,  
Petaling Jaya, Selangor, Malaysia  
Tel: 03-78030900

### SINGAPORE

**Yamaha Music (Asia) PRIVATE LIMITED**  
Blk 202 Hougang Street 21, #02-00,  
Singapore 530202, Singapore  
Tel: 6747-4374

### TAIWAN

**Yamaha KHS Music Co., Ltd.**  
3F, #6, Sec.2, Nan Jing E. Rd. Taipei.  
Taiwan 104, R.O.C.  
Tel: 02-2511-8688

### THAILAND

**Siam Music Yamaha Co., Ltd.**  
4, 6, 15 and 16th floor, Siam Motors Building,  
891/1 Rama 1 Road, Wangmai,  
Pathumwan, Bangkok 10330, Thailand  
Tel: 02-215-2622

### VIETNAM

**Yamaha Music Vietnam Company Limited**  
15th Floor, Nam A Bank Tower, 201-203 Cach  
Mang Thang Tam St., Ward 4, Dist.3,  
Ho Chi Minh City, Vietnam  
Tel: +84-8-3818-1122

### OTHER ASIAN COUNTRIES

**Yamaha Corporation,**  
**Asia-Pacific Sales & Marketing Group**  
Nakazawa-cho 10-1, Naka-ku, Hamamatsu,  
Japan 430-8650  
Tel: +81-53-460-2303

## OCEANIA

### AUSTRALIA

**Yamaha Music Australia Pty. Ltd.**  
Level 1, 99 Queensbridge Street, Southbank,  
Victoria 3006, Australia  
Tel: 3-9693-5111

### COUNTRIES AND TRUST TERRITORIES IN PACIFIC OCEAN

**Yamaha Corporation,**  
**Asia-Pacific Sales & Marketing Group**  
Nakazawa-cho 10-1, Naka-ku, Hamamatsu,  
Japan 430-8650  
Tel: +81-53-460-2303



Yamaha Pro Audio global web site:  
<http://www.yamahaproaudio.com/>

Yamaha Manual Library:  
<http://www.yamaha.co.jp/manual/>

C.S.G., Pro Audio Division  
© 2006 Yamaha Corporation

305POTO-D0  
Printed in Japan

WH65390