



**AV Receiver**

**RX-V575**  
**RX-V475**

**Owner's Manual**

---

Read the supplied booklet "Safety Brochure" before using the unit.

**English**

# CONTENTS

Accessories .....	4
-------------------	---

## FEATURES 5

---

What you can do with the unit .....	5
-------------------------------------	---

Part names and functions .....	7
--------------------------------	---

Front panel .....	7
Front display (indicators) .....	8
Rear panel .....	9
Remote control .....	10

## PREPARATIONS 11

---

General setup procedure .....	11
-------------------------------	----

1 Placing speakers .....	12
--------------------------	----

2 Connecting speakers .....	15
-----------------------------	----

5.1-channel system .....	15
7.1-channel system .....	15
Connecting front speakers that support bi-amp connections .....	16
Connecting Zone B speakers .....	16

Input/output jacks and cables .....	17
-------------------------------------	----

3 Connecting a TV .....	18
-------------------------	----

4 Connecting playback devices .....	23
-------------------------------------	----

Connecting video devices (such as BD/DVD players) .....	23
Connecting audio devices (such as CD players) .....	26
Connecting to the jacks on the front panel .....	26

5 Connecting the FM/AM antennas .....	27
---------------------------------------	----

6 Connecting to a network .....	28
---------------------------------	----

7 Connecting recording devices .....	29
--------------------------------------	----

8 Connecting the power cable .....	29
------------------------------------	----

9 Selecting an on-screen menu language .....	30
--	----

10 Optimizing the speaker settings automatically (YPAO) .....	31
---	----

Error messages .....	33
Warning messages .....	34

## PLAYBACK 35

---

Basic playback procedure .....	35
--------------------------------	----

Selecting the input source and favorite settings with one touch	
---	--

(SCENE) .....	36
---------------	----

Configuring scene assignments .....	36
-------------------------------------	----

Selecting the sound mode .....	37
--------------------------------	----

Enjoying sound field effects (CINEMA DSP) .....	38
Enjoying unprocessed playback .....	40
Enjoying pure high fidelity sound (direct playback) .....	41
Enjoying compressed music with enhanced sound (Compressed Music Enhancer) .....	42
Enjoying surround sound with headphones (SILENT CINEMA) .....	42

Listening to FM/AM radio .....	43
--------------------------------	----

Setting the frequency steps .....	43
Selecting a frequency for reception .....	43
Registering favorite radio stations (presets) .....	44
Radio Data System tuning .....	46

Playing back iPod music .....	47
-------------------------------	----

Connecting an iPod .....	47
Playback of iPod content .....	48

Playing back music stored on a USB storage device .....	51
---	----

Connecting a USB storage device .....	51
Playback of USB storage device contents .....	51

<b>Playing back music stored on media servers (PCs/NAS)</b> .....	<b>54</b>
Media sharing setup .....	54
Playback of PC music contents .....	54
<b>Listening to Internet radio</b> .....	<b>57</b>
<b>Playing back iTunes/iPod music via a network (AirPlay)</b> .....	<b>59</b>
Playback of iTunes/iPod music contents .....	59
<b>Playing back music in multiple rooms (RX-V575 only)</b> .....	<b>61</b>
Preparing Zone B .....	61
<b>Viewing the current status</b> .....	<b>63</b>
Switching information on the front display .....	63
<b>Configuring playback settings for different playback sources (Option menu)</b> .....	<b>64</b>
Option menu items .....	64

## **CONFIGURATIONS** **68**

---

<b>Configuring various functions (Setup menu)</b> .....	<b>68</b>
Setup menu items .....	69
Speaker .....	71
HDMI .....	74
Sound .....	75
ECO .....	77
Function .....	78
Network .....	80
Language .....	82
<b>Configuring the system settings (ADVANCED SETUP menu)</b> .....	<b>83</b>
ADVANCED SETUP menu items .....	83
Changing the speaker impedance setting (SP IMP.) .....	83
Selecting the remote control ID (REMOTE ID) .....	83
Changing the FM/AM tuning frequency setting (TU) .....	84
Switching the video signal type (TV FORMAT) .....	84
Restoring the default settings (INIT) .....	84
Updating the firmware (UPDATE) .....	84
Checking the firmware version (VERSION) .....	84

<b>Controlling external devices with the remote control</b> .....	<b>85</b>
Registering the remote control code for a TV .....	85
Registering the remote control codes for playback devices .....	86
Resetting remote control codes .....	87
<b>Updating the unit's firmware via the network</b> .....	<b>88</b>

## **APPENDIX** **89**

---

<b>Frequently asked questions</b> .....	<b>89</b>
<b>Troubleshooting</b> .....	<b>90</b>
Power, system and remote control .....	90
Audio .....	92
Video .....	94
FM/AM radio .....	94
USB and network .....	95
<b>Error indications on the front display</b> .....	<b>96</b>
<b>Glossary</b> .....	<b>97</b>
Audio information .....	97
HDMI and video information .....	98
Yamaha technologies .....	99
Video signal flow .....	100
<b>Information on HDMI</b> .....	<b>100</b>
HDMI Control .....	100
HDMI signal compatibility .....	102
<b>Reference diagram (rear panel)</b> .....	<b>103</b>
<b>Trademarks</b> .....	<b>104</b>
<b>Specifications</b> .....	<b>105</b>
<b>Index</b> .....	<b>108</b>

## Accessories

Check that the following accessories are supplied with the product.

Remote control

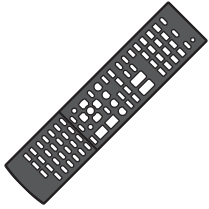

Batteries (AAA, R03, UM-4) (x2)

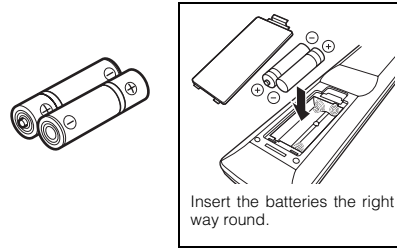

AM antenna



FM antenna

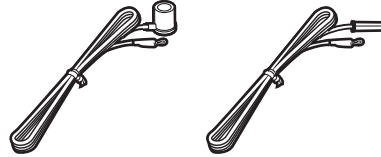

\*One of the above is supplied depending on the region of purchase.

YPAO microphone

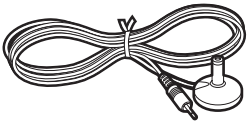

CD-ROM (Owner's Manual)



Easy Setup Guide



Safety Brochure



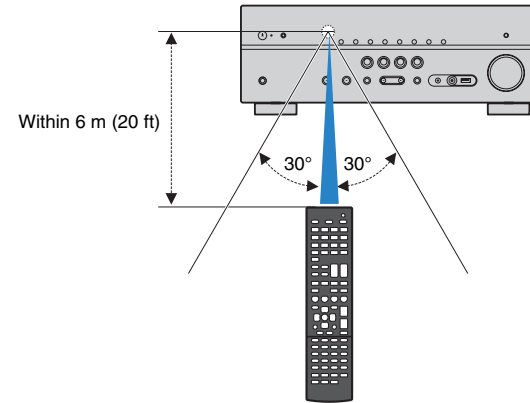

### Operating range of the remote control

- Point the remote control at the remote control sensor on the unit and remain within the operating range shown below.



- The illustrations of the main unit and remote control used in this manual are of the RX-V575 (U.S.A. model), unless otherwise specified.

- Some features are not available in certain regions.
- Due to product improvements, specifications and appearance are subject to change without notice.
- This manual explains operations using the supplied remote control.
- This manual describes all the "iPod", "iPhone" and "iPad" as the "iPod". "iPod" refers to "iPod", "iPhone" and "iPad", unless otherwise specified.
-  indicates precautions for use of the unit and its feature limitations.
-  indicates supplementary explanations for better use.

# FEATURES

## What you can do with the unit

### Wide variety of supported content

- iPod/iPhone/iPad ➔ p.47
- USB ➔ p.51
- Media server (PC/NAS) ➔ p.54
- Internet radio ➔ p.57
- AirPlay ➔ p.59

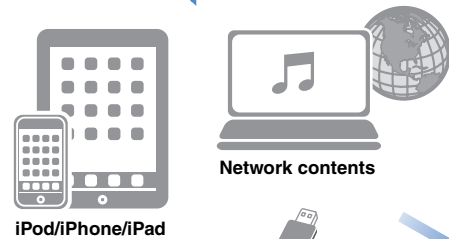

iPod/iPhone/iPad

Network contents

USB device

### 3D and 4K signals supported

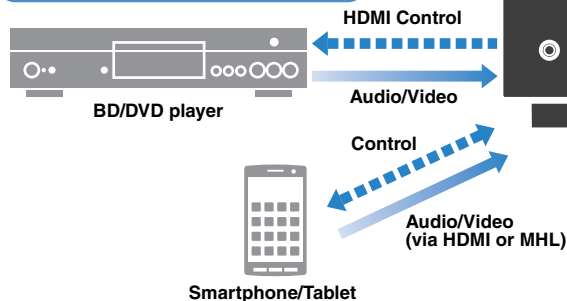

BD/DVD player

Smartphone/Tablet

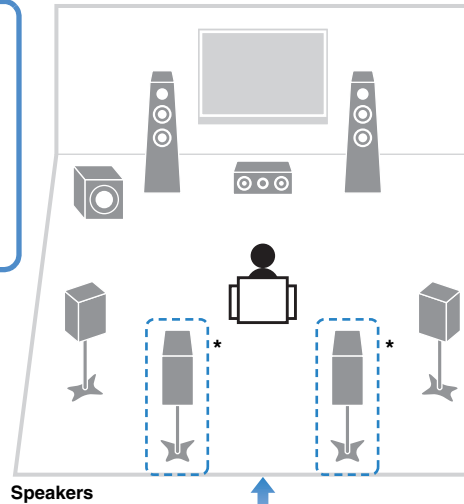

Speakers

Audio

Supports 2- to 5.1-channel (to 7.1-channel\*) speaker system. Allows you to enjoy your favorite acoustic spaces in various styles.

- Automatically optimizing the speaker settings to suit your room (YPAO) ➔ p.31
- Reproducing stereo or multichannel sounds with the sound fields like actual movie theaters and concert halls (CINEMA DSP) ➔ p.38
- Enjoying compressed music with enhanced sound (Compressed Music Enhancer) ➔ p.42
- Playing back music in multiple rooms (Zone B)\* ➔ p.61

\* RX-V575 only

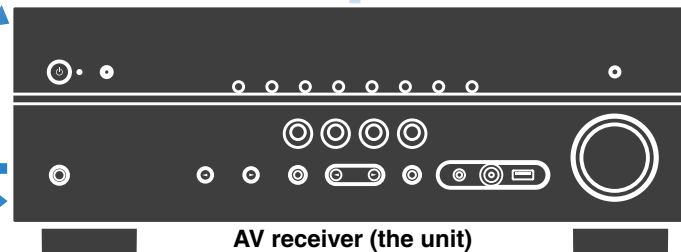

AV receiver (the unit)

Change the input source and favorite settings with one touch (SCENE) ➔ p.36

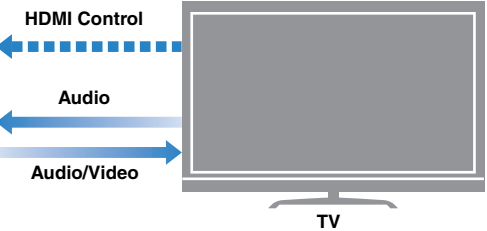

TV



TV remote control

Sequential operation of a TV, AV receiver, and BD/DVD player (HDMI Control) ➔ p.100

## Full of useful functions!

### ❑ Connecting various devices (p.23)

A number of HDMI jacks and various input/output jacks on the unit allow you to connect video devices (such as BD/DVD players), audio devices (such as CD players), game consoles, camcorders, and other devices.

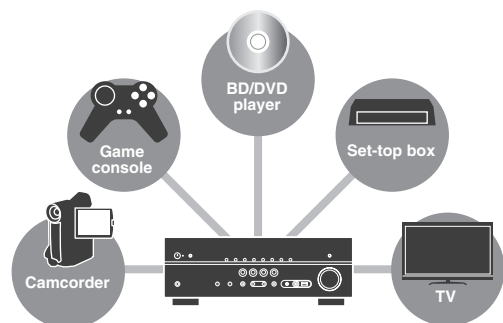

### ❑ Playing back TV audio in surround sound with a single HDMI cable connection (Audio Return Channel: ARC) (p.18)

When using an ARC-compatible TV, you only need one HDMI cable to enable video output to the TV, audio input from the TV, and the transmission of HDMI Control signals.

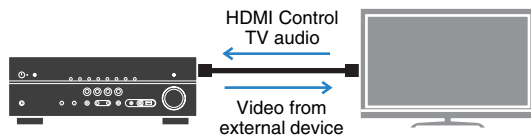

### ❑ Easy operation and wireless music playback from iPhone or Android device

By using the application for smartphone/tablet "AV CONTROLLER", you can control the unit from an iPhone, iPad, iPod touch or Android devices. Visit our website for details.

### ❑ Creating 3-dimensional sound fields (p.38)

The Virtual Presence Speaker (VPS) function allows you to create a 3-dimensional sound field in your own room (CINEMA DSP 3D).

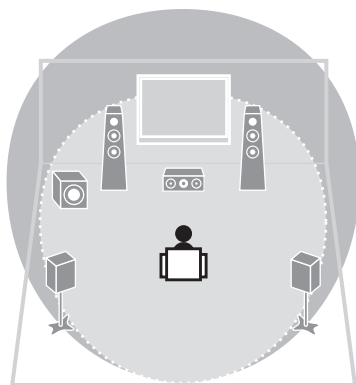

### ❑ Listening to FM/AM radio (p.43)

The unit is equipped with a built-in FM/AM tuner. You can register up to 40 favorite radio stations as presets.

### ❑ Enjoying pure high fidelity sound (p.41)

When the direct playback mode is enabled, the unit plays back the selected source with the least circuitry, which lets you to enjoy Hi-Fi sound quality.

### ❑ Easy operation with a TV screen

You can operate the iPod or USB storage device, view information, or easily configure the settings using the on-screen menu.

### ❑ Low power consumption

The ECO mode (power saving function) reduces the unit's power consumption and helps to create an eco-friendly home theater system (p.78).

## Useful tips

### The combination of video/audio input jacks does not match an external device...

Use "Audio In" in the "Option" menu to change the combination of video/audio input jacks so that it matches the output jack(s) of your external device (p.25).

### Video and audio are not synchronized...

Use "Lipsync" in the "Setup" menu to adjust the delay between video and audio output (p.76).

### I want to hear audio from the TV speakers...

Use "Audio Output" in the "Setup" menu to select the output destination of signals input into the unit (p.74). Your TV speakers may be selected as an output destination.

### I want to use the supplied remote control to operate external devices...

Register the remote control codes of the external devices (such as a TV and BD/DVD players) (p.85).

### I want to change the on-screen menu language...

Use "Language" in the "Setup" menu to select a language from English, Japanese, French, German, Spanish, Russian, Italian and Chinese (p.30).

### I want to update the firmware...

Use "Network Update" (p.88) in the "Setup" menu or "UPDATE" (p.84) in the "ADVANCED SETUP" menu to update the unit's firmware.

### Many other settings are available that let you to customize the unit. For details, see the following pages.

- SCENE settings (p.36)
- Sound/video settings and signal information for each source (p.64)
- Various function settings (p.69)
- System settings (p.83)

## Part names and functions

### Front panel

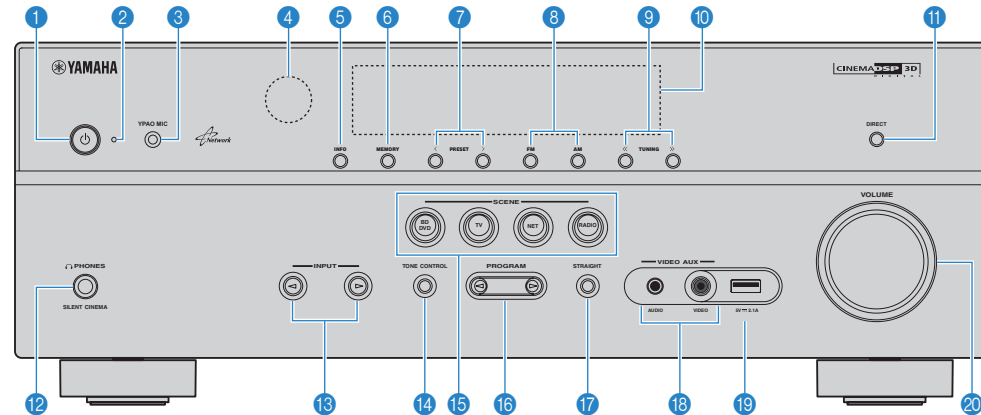

- 1** **⏻ (power) key**  
Turns on/off (standby) the unit.
- 2** **Standby indicator**  
Lights up when the unit is in standby mode under any of the following conditions.
  - HDMI Control is enabled (p.74)
  - Standby Through is enabled (p.74)
  - Network Standby is enabled (p.81)
  - An iPod is being charged (p.47)
- 3** **YPAO MIC jack**  
For connecting the supplied YPAO microphone (p.31).
- 4** **Remote control sensor**  
Receives remote control signals (p.4).
- 5** **INFO key**  
Selects the information displayed on the front display (p.63).
- 6** **MEMORY key**  
Registers FM/AM radio stations as preset stations (p.44).
- 7** **PRESET keys**  
Select a preset FM/AM radio station (p.45).
- 8** **FM and AM keys**  
Switch between FM and AM (p.43).
- 9** **TUNING keys**  
Select the radio frequency (p.43).
- 10** **Front display**  
Displays information (p.8).
- 11** **DIRECT key**  
Enables/disables the direct playback mode (p.41).
- 12** **PHONES jack**  
For connecting headphones.
- 13** **INPUT keys**  
Select an input source.
- 14** **TONE CONTROL key**  
Adjusts the high-frequency range and low-frequency range of output sounds (p.65).
- 15** **SCENE keys**  
Select the registered input source and sound program with one touch. Also, turns on the unit when it is in standby mode (p.36).
- 16** **PROGRAM keys**  
Select a sound program or a surround decoder (p.37).
- 17** **STRAIGHT key**  
Enables/disables the straight decode mode (p.40).
- 18** **VIDEO AUX jacks**  
For connecting devices, such as camcorders and game consoles (p.26).
- 19** **USB jack**  
For connecting a USB storage device (p.51) or an iPod (p.47).
- 20** **VOLUME knob**  
Adjusts the volume.

## Front display (indicators)

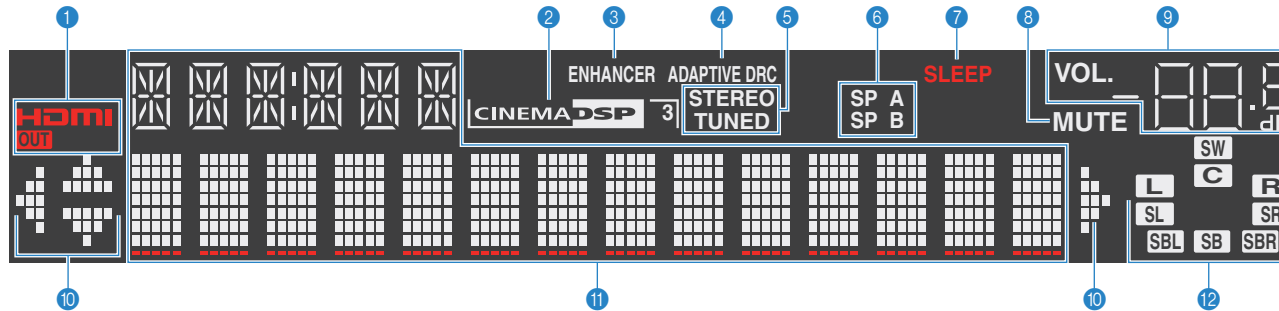

### 1 HDMI

Lights up when HDMI signals are being input or output.

### OUT

Lights up when HDMI signals are being output.

### 2 CINEMA DSP

Lights up when CINEMA DSP (p.38) is working.

### CINEMA DSP 3D

Lights up when CINEMA DSP 3D (p.40) is working.

### 3 ENHANCER

Lights up when Compressed Music Enhancer (p.42) is working.

### 4 ADAPTIVE DRC

Lights up when Adaptive DRC (p.65) is working.

### 5 STEREO

Lights up when the unit is receiving a stereo FM radio signal.

### TUNED

Lights up when the unit is receiving an FM/AM radio station signal.

### 6 ZONE indicators (RX-V575 only)

"SP A" lights up when the Zone A speaker output is enabled and "SP B" lights up when the Zone B speaker output is enabled (p.62).

### 7 SLEEP

Lights up when the sleep timer is on.

### 8 MUTE

Blinks when audio is muted.

### 9 Volume indicator

Indicates the current volume.

### 10 Cursor indicators

Indicate the remote control cursor keys currently operational.

### 11 Information display

Displays the current status (such as input name and sound mode name). You can switch the information by pressing INFO (p.63).

### 12 Speaker indicators

Indicate speaker terminals from which signals are output.

**SW** Subwoofer

**L** Front speaker (L)

**R** Front speaker (R)

**C** Center speaker

**SL** Surround speaker (L)

**SR** Surround speaker (R)

**SBL** Surround back speaker (L)\*

**SBR** Surround back speaker (R)\*

**SB** Surround back speaker\*

\* RX-V575 only



# Rear panel

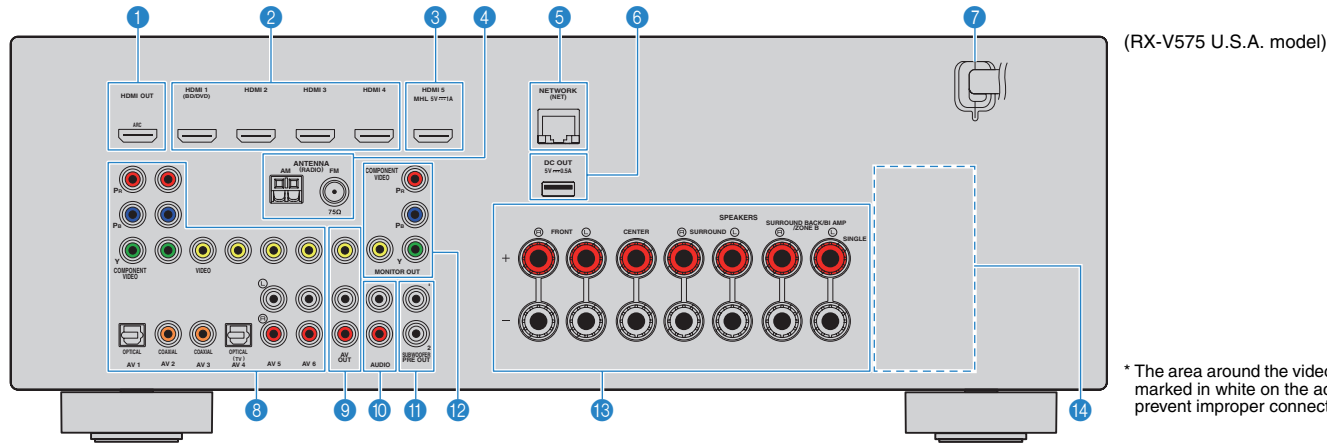

\* The area around the video/audio output jacks is marked in white on the actual product to prevent improper connections.

## 1 HDMI OUT jack

For connecting to an HDMI-compatible TV and outputting video/audio signals (p.18). When using ARC, TV audio signal can also be input through the HDMI OUT jack.

## 2 HDMI 1–4 jacks

For connecting to HDMI-compatible playback devices and inputting video/audio signals (p.23).

## 3 HDMI 5/MHL jack

For connecting to an HDMI- or MHL-compatible playback device and inputting video/audio signals (p.23).

## 4 ANTENNA jacks

For connecting to FM and AM antennas (p.27).

## 5 NETWORK jack

For connecting to a network (p.28).

## 6 DC OUT jack

For supplying power to a Yamaha AV accessory. For details on connections, refer to the instruction manual of the AV accessory.

## 7 Power cable

For connecting to an AC wall outlet (p.29).

## 8 AV 1–6 jacks

For connecting to video/audio playback devices and inputting video/audio signals (p.23).

## 9 AV OUT jacks

For outputting video/audio to a recording device (such as a VCR) (p.29).

## 10 AUDIO jacks

For connecting to an audio playback device and inputting audio signals (p.26).

## 11 SUBWOOFER PRE OUT 1–2 jacks (RX-V575)

### SUBWOOFER PRE OUT jack (RX-V475)

For connecting to a subwoofer (with built-in amplifier) (p.15).



- (RX-V575 only)

You can connect 2 subwoofers (with built-in amplifier) to the unit.

## 12 MONITOR OUT jacks

### COMPONENT VIDEO jacks:

For connecting to a TV that supports component video and outputting video signals (p.22).

### VIDEO jack:

For connecting to a TV that supports composite video and outputting video signals (p.22).

## 13 SPEAKERS terminals

For connecting to speakers (p.15).



- The SURROUND BACK/BI AMP/ZONE B jacks are available on RX-V575 only.

## 14 VOLTAGE SELECTOR

(General model only)

Selects the switch position according to your local voltage (p.29).

# Remote control

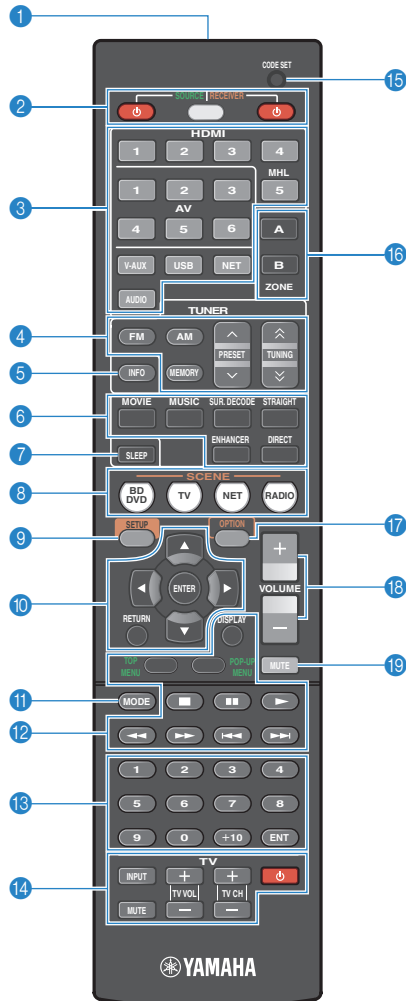

(RX-V575)

## 1 Remote control signal transmitter

Transmits infrared signals.

## 2 SOURCE key

Turns on/off an external device.

## SOURCE/RECEIVER key

Changes the device (the unit or external device) that is operated with the remote control (p.86). You can operate the unit when this key lights up in orange, and an external device when this key lights up in green.

## RECEIVER key

Turns on/off (standby) the unit.

## 3 Input selection keys

Select an input source for playback.

**HDMI 1-4** HDMI 1-4 jacks

**HDMI 5/MHL** HDMI 5/MHL jack

**AV 1-6** AV 1-6 jacks

**V-AUX** VIDEO AUX jack (on the front panel)

**USB** USB jack (on the front panel)

**NET** NETWORK jack (press repeatedly to select a desired network source)

**AUDIO** AUDIO jacks

## 4 Radio keys

Operate the FM/AM radio (p.43).

**FM** Switches to FM radio.

**AM** Switches to AM radio.

**MEMORY** Registers FM/AM radio stations as presets.

**PRESET** Select a preset station.

**TUNING** Select the radio frequency.

## 5 INFO key

Selects the information displayed on the front display (p.63).

## 6 Sound mode keys

Select a sound mode (p.37).

## 7 SLEEP key

Switches the unit to standby mode automatically after a specified period of time has elapsed (sleep timer). Press repeatedly to set the time (120 min, 90 min, 60 min, 30 min, off).

## 8 SCENE keys

Select the registered input source and sound program with one touch. Also, turns on the unit when it is in standby mode (p.36).

## 9 SETUP key

Displays the setup menu (p.68).

## 10 Menu operation keys

**Cursor keys** Select a menu or a parameter.

**ENTER** Confirms a selected item.

**RETURN** Returns to the previous screen.

## 11 MODE key

Switches between "Stereo" and "Mono" for FM radio reception (p.43).

Switches the iPod operation modes (p.49).

## 12 External device operation keys

Let you play back and select menus and perform other operations for external devices (p.86).

## 13 Numeric keys

Let you enter numerical values, such as radio frequencies.

## 14 TV operation keys

Let you select TV input and volume, and perform other TV operations (p.85).

## 15 CODE SET button

Registers remote control codes of external devices on the remote control (p.85).

## 16 ZONE keys (RX-V575 only)

Enable/disable the audio output to Zone A or Zone B (p.62).

## ★/★★ keys (RX-V475 only)

Change the external device to be controlled without switching the input source (p.86).

## 17 OPTION key

Displays the option menu (p.64).

## 18 VOLUME keys

Adjust the volume.

## 19 MUTE key

Mutes the audio output.



- To operate external devices with the remote control, register a remote control code for each device before using (p.85).

# PREPARATIONS

## General setup procedure

- 1 Placing speakers (p.12)** Select the speaker layout for the number of speakers that you are using and place them in your room.
- 2 Connecting speakers (p.15)** Connect the speakers to the unit.
- 3 Connecting a TV (p.18)** Connect a TV to the unit.
- 4 Connecting playback devices (p.23)** Connect video devices (such as BD/DVD players) and audio devices (such as CD players) to the unit.
- 5 Connecting the FM/AM antennas (p.27)** Connect the supplied FM/AM antennas to the unit.
- 6 Connecting to a network (p.28)** Connect the unit to a network.
- 7 Connecting recording devices (p.29)** Connect recording devices to the unit.
- 8 Connecting the power cable (p.29)** After all the connections are complete, plug in the power cable.
- 9 Selecting an on-screen menu language (p.30)** Select the desired on-screen menu language (default: English).
- 10 Optimizing the speaker settings automatically (YPAO) (p.31)** Optimize the speaker settings, such as volume balance and acoustic parameters, to suit your room (YPAO).

This completes all the preparations. Enjoy playing movies, music, radio and other content with the unit!

# 1 Placing speakers

Select the speaker layout for the number of speakers that you are using and place the speakers and subwoofer in your room. This section describes the representative speaker layout examples.

**Caution**

- (U.S.A. and Canada models only)  
Under its default settings, the unit is configured for 8-ohm speakers. When connecting 6-ohm speakers, set the unit's speaker impedance to "6 Ω MIN". In this case, you can also use 4-ohm speakers as the front speakers. For details, see "Setting the speaker impedance" (p.14).
- (Except for U.S.A. and Canada models)  
Use speakers with an impedance of at least 6 Ω.

Speaker type	Abbr.	Function	Speaker system (the number of channels)					
			7.1*	6.1*	5.1	4.1	3.1	2.1
Front (L)	<b>FL</b>	Produce front right/left channel sounds (stereo sounds).	●	●	●	●	●	●
Front (R)	<b>FR</b>		●	●	●	●	●	●
Center	<b>C</b>	Produces center channel sounds (such as movie dialogue and vocals).	●	●	●		●	
Surround (L)	<b>SL</b>	Produce surround right/left channel sounds.	●	●	●	●		
Surround (R)	<b>SR</b>		●	●	●	●		
Surround back (L)*	<b>SBL</b>	Produce surround back left/right channel sounds.	●					
Surround back (R)*	<b>SBR</b>		●					
Surround back*	<b>SB</b>	Produces sounds mixed from surround back left/right channel sounds.		●				
Subwoofer	<b>SW</b>	Produces LFE (low-frequency effect) channel sounds and reinforces the bass parts of other channels. This channel is counted as "0.1". You can connect 2 subwoofers (with built-in amplifier) to the unit.*	●	●	●	●	●	●

\* RX-V575 only



- RX-V575 supports 2- to 7.1-channel system, and RX-V475 supports 2- to 5.1-channel speaker system.
- (RX-V575 only)  
Two subwoofers connected to the unit output the same sounds.

## 7.1-channel system (RX-V575 only)

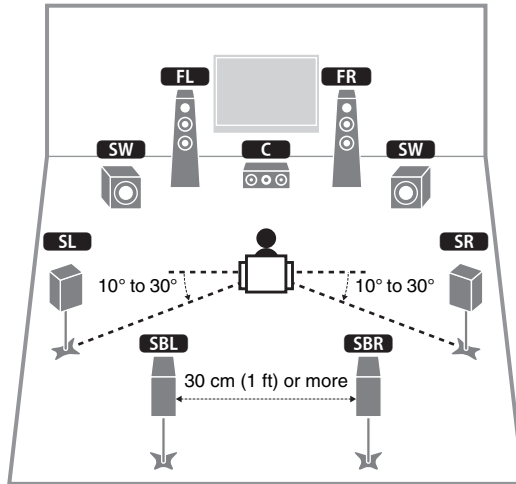

## 5.1-channel system

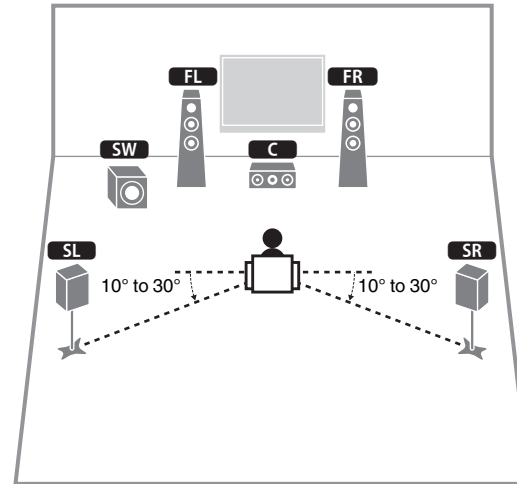

## 6.1-channel system (RX-V575 only)

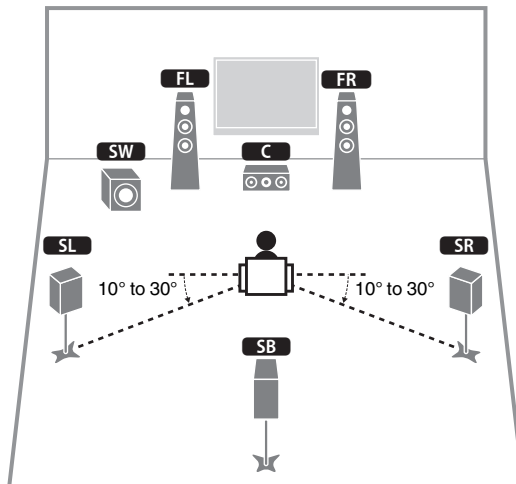

## 4.1-channel system

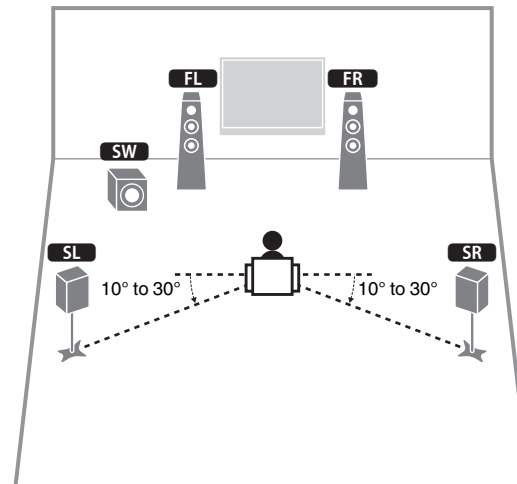

## 3.1-channel system

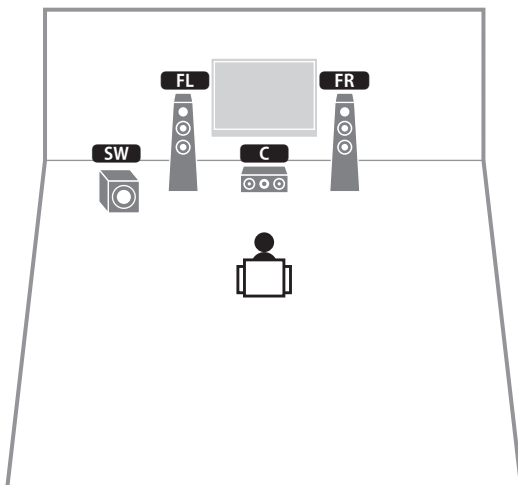

## 2.1-channel system

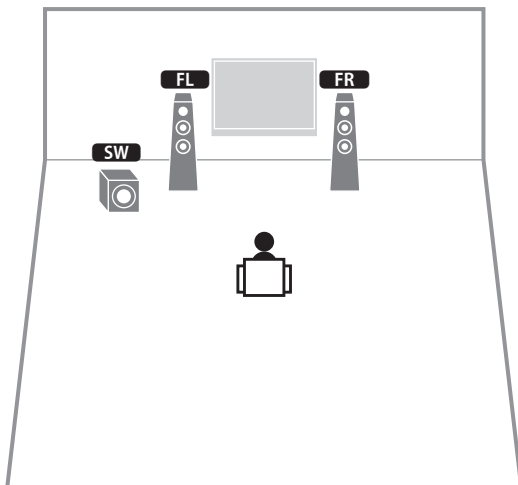

## ■ Setting the speaker impedance

(U.S.A. and Canada models only)

Under its default settings, the unit is configured for 8-ohm speakers. When connecting 6-ohm speakers, set the speaker impedance to “6 Ω MIN”. In this case, you can also use 4-ohm speakers as the front speakers.

- 1 Before connecting speakers, connect the power cable to an AC wall outlet.
- 2 While holding down STRAIGHT on the front panel, press  (power).

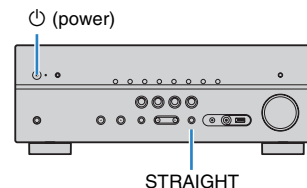

- 3 Check that “SP IMP.” is displayed on the front display.



- 4 Press STRAIGHT to select “6 Ω MIN”.
- 5 Press  (power) to set the unit to standby mode and remove the power cable from the AC wall outlet.

You are now ready to connect the speakers.

## 2 Connecting speakers

Connect the speakers placed in your room to the unit. The following diagrams provide connections for 5.1- and 7.1-channel systems as examples. For other systems, connect speakers while referring to the connection diagram for the 5.1-channel system.

### Caution

- Remove the unit's power cable from an AC wall outlet and turn off the subwoofer before connecting the speakers.
- Ensure that the core wires of the speaker cable do not touch one another or come into contact with the unit's metal parts. Doing so may damage the unit or the speakers. If the speaker cables short circuit, "Check SP Wires" will appear on the front display when the unit is turned on.

### Cables required for connection (commercially available)

Speaker cables (x the number of speakers)



Audio pin cable (x1: for connecting a subwoofer)



### 5.1-channel system

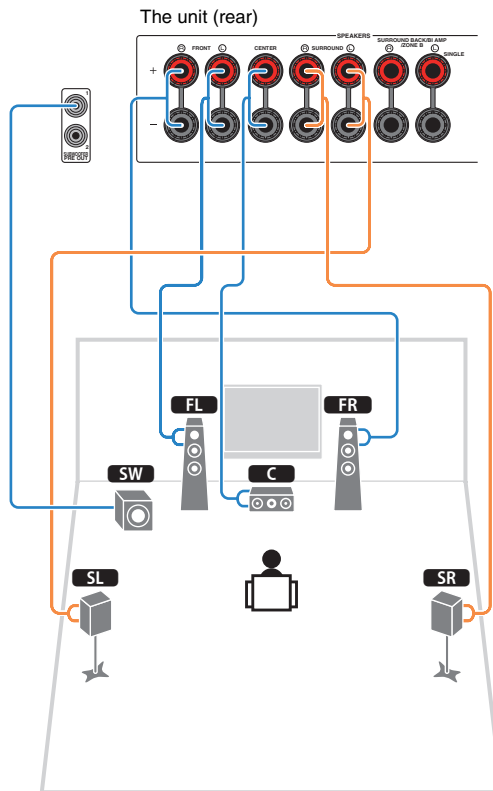

- (RX-V575 only)  
You can connect 2 subwoofers (with built-in amplifier) to the unit. The 2 subwoofers output the same sound.

### 7.1-channel system

(RX-V575 only)

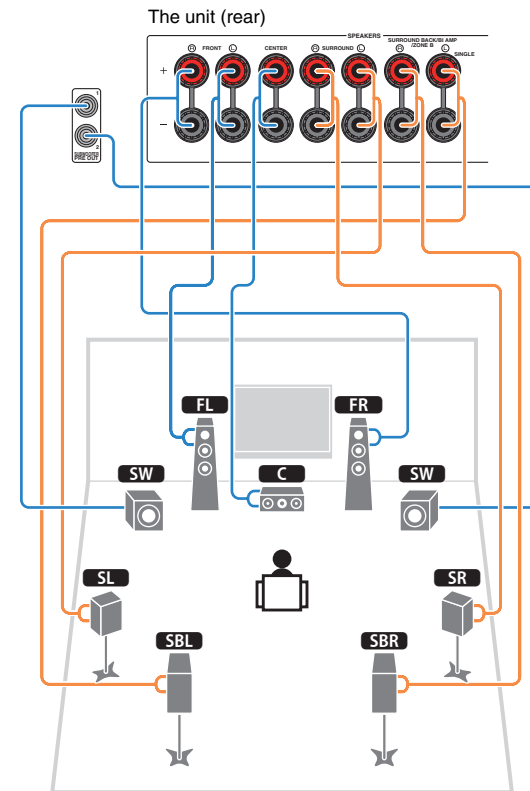

- When using only one surround back speaker, connect it to the SINGLE jack (L side).

## ■ Connecting speaker cables

Speaker cables have two wires. One is for connecting the negative (-) terminal of the unit and the speaker, and the other is for the positive (+) terminal. If the wires are colored to prevent confusion, connect the black wire to the negative and the other wire to the positive terminal.

- ① Remove approximately 10 mm (3/8") of insulation from the ends of the speaker cable and twist the bare wires of the cable firmly together.
- ② Loosen the speaker terminal.
- ③ Insert the bare wires of the cable into the gap on the side (upper right or bottom left) of the terminal.
- ④ Tighten the terminal.

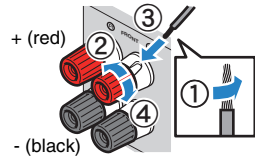

### Using a banana plug

(U.S.A., Canada, China, Australia and General models only)

- ① Tighten the speaker terminal.
- ② Insert a banana plug into the end of the terminal.

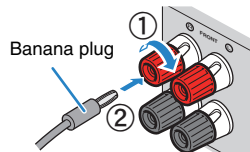

## ■ Connecting the subwoofer (with built-in amplifier)

Use an audio pin cable to connect the subwoofer.

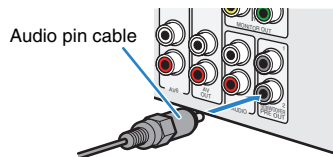

## Connecting front speakers that support bi-amp connections

(RX-V575 only)

When using front speakers that support bi-amp connections, connect them to the FRONT jacks and SURROUND BACK/BI-AMP/ZONE B jacks.

To enable the bi-amp function, set "Power Amp Assign" (p.71) in the "Setup" menu to "BI-AMP" after connecting the power cable to an AC wall outlet.

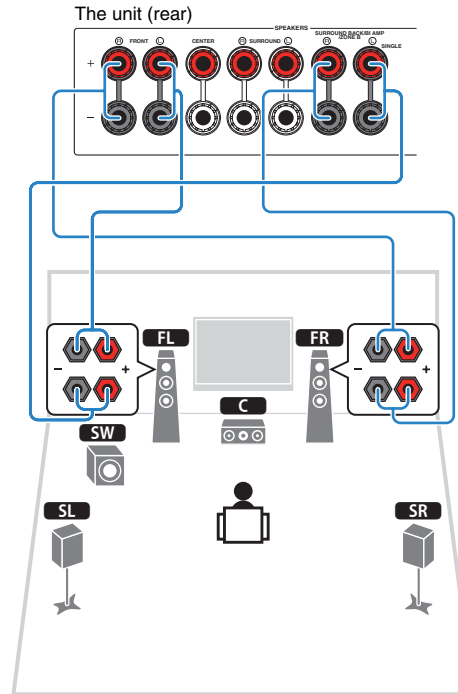

- The FRONT jacks and SURROUND BACK/BI-AMP/ZONE B jacks output the same signals.

### Caution

- Before making bi-amp connections, remove any brackets or cables that connect a woofer with a tweeter. Refer to the instruction manual of the speakers for details. If you are not making bi-amp connections, make sure that the brackets or cables are connected before connecting the speaker cables.
- Surround back speakers cannot be used during bi-amp connections.

## Connecting Zone B speakers

(RX-V575 only)

The Zone A/B function allows you to playback an input source in the room where the unit is installed (Zone A) and in another room (Zone B). To connect the Zone B speakers, see "Playing back music in multiple rooms (RX-V575 only)" (p.61).



# Input/output jacks and cables

## Video/audio jacks

### HDMI jacks

Transmit digital video and digital sound through a single jack. Use an HDMI cable.

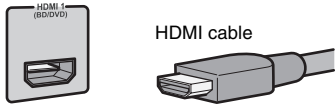

- Use a 19-pin HDMI cable with the HDMI logo. We recommend using a cable less than 5.0 m (16.4 ft) long to prevent signal quality degradation.



- The unit's HDMI jacks support the HDMI Control, Audio Return Channel (ARC), and 3D and 4K video transmission (through output features).
- Use high speed HDMI cables to enjoy 3D or 4K videos.

### HDMI/MHL jack

Transmit digital video and digital sound. Use an MHL cable.



- The HDMI 5/MHL jack of the unit supports both HDMI and MHL connections. Use a cable that matches the jack on your MHL-compatible mobile device. When connecting an HDMI-compatible playback device to the jack, use an HDMI cable. For details on an MHL connection, see "MHL connection" (p.23).

## Video jacks

### COMPONENT VIDEO jacks

Transmit video signals separated into three components: luminance (Y), chrominance blue (Pb), and chrominance red (Pr). Use a component video cable with three plugs.

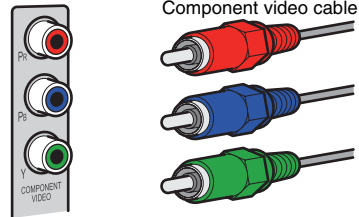

### VIDEO jacks

Transmit analog video signals. Use a video pin cable.

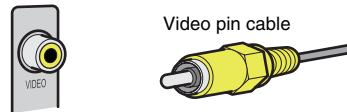

## Audio jacks

### OPTICAL jacks

Transmit digital audio signals. Use a digital optical cable. Remove the tip protector (if available) before using the cable.

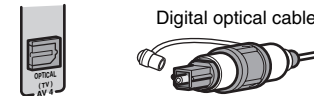

### COAXIAL jacks

Transmit digital audio signals. Use a digital coaxial cable.



### AUDIO jacks

#### (Stereo L/R jacks)

Transmit analog stereo audio signals. Use a stereo pin cable (RCA cable).

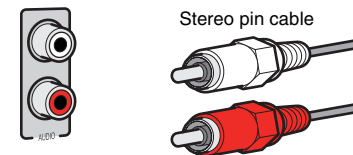

#### (Stereo mini jack)

Transmits analog stereo audio signals. Use a stereo mini-plug cable.



### 3 Connecting a TV

Connect a TV to the unit so that video input to the unit can be output to the TV.  
 You can also enjoy playback of TV audio on the unit.  
 The connection method varies depending on the functions and video input jacks available on your TV.  
 Refer to the instruction manual of the TV and choose a connection method.

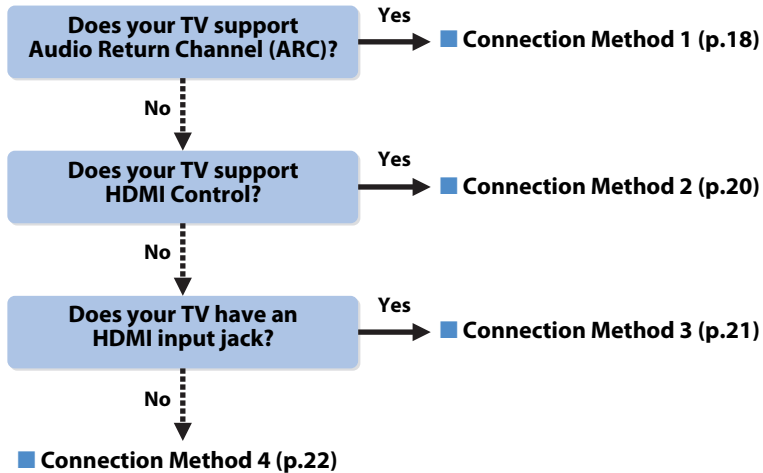

**When connecting a video device with an analog video output**

- If you will connect any video device to the AV 1–2 (COMPONENT VIDEO) jacks of the unit, you also need to connect the TV to the MONITOR OUT (COMPONENT VIDEO) jacks (p.22).
- If you will connect any video device to the AV 3–6 (VIDEO) jacks or the VIDEO AUX (VIDEO) of the unit, you also need to connect the TV to the MONITOR OUT (VIDEO) jack (p.22).

**When using a set-top box to watch TV**

- Connect the set-top box to the unit in the same way as playback devices (p.23). If you will receive TV broadcasts only from the set-top box, you do not need to make an audio cable connection between the TV and the unit or configure the ARC setting.

**About HDMI Control**  
 HDMI Control allows you to operate external devices via HDMI. If you connect a TV that supports HDMI Control to the unit with an HDMI cable, you can control the unit's power and volume with the TV's remote control. You can also control playback devices (such as an HDMI Control-compatible BD/DVD player) connected to the unit with an HDMI cable. For details, see "HDMI Control" (p.100).

**About Audio Return Channel (ARC)**  
 ARC allows audio signals to travel both ways under HDMI Control. If you connect a TV that supports HDMI Control and ARC to the unit with a single HDMI cable, you can output video/audio to the TV or input TV audio to the unit.

#### ■ Connection Method 1 (HDMI Control/ARC-compatible TV)

Connect the TV to the unit with an HDMI cable.

- ! The following explanation is based on the assumption that you have not changed the "HDMI" parameters (p.74) in the "Setup" menu.
- Use an HDMI cable that supports ARC.

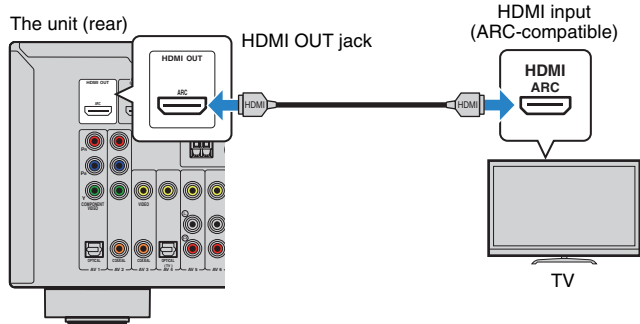

- 💡 By connecting a TV to the unit with an HDMI cable, you can navigate the iPod, USB storage device and network sources, or configure the settings of the unit with the menu displayed on the TV.

## □ Necessary settings

To use HDMI Control and ARC, you need to configure the following settings.  
For details on settings and operating your TV, refer to the instruction manual for the TV.

### 1 After connecting external devices (such as a TV and playback devices) and the power cable to the unit, turn on the unit, TV, and playback devices.

### 2 Configure the settings of the unit.

- ① Check that ARC is enabled on the TV.
- ② Switch the TV input to display video from the unit.
- ③ Press SETUP.

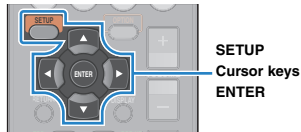

- ④ Use the cursor keys to select "HDMI" and press ENTER.

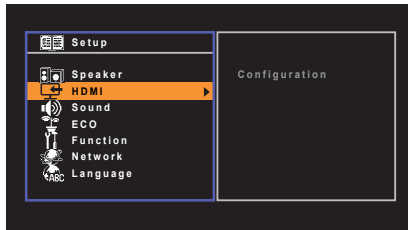

- ⑤ Press ENTER again.
- ⑥ Use the cursor keys (Δ/▽) to select "HDMI Control" and the cursor keys (◀/▶) to select "On" as shown below.

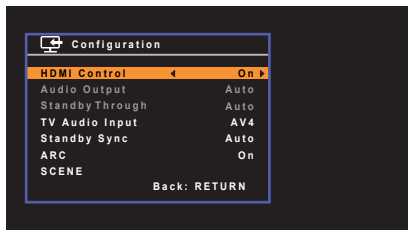

- ⑦ Press SETUP.

### 3 Configure the settings for HDMI Control.

- ① Enable HDMI Control on the TV and playback devices (such as HDMI Control-compatible BD/DVD player).
- ② Turn off the TV's main power and then turn off the unit and playback devices.
- ③ Turn on the unit and playback devices and then turn on the TV's main power.
- ④ Switch the TV input to display video from the unit.
- ⑤ Check the following.

**On the unit:** The input to which the playback device is connected is selected. If not, select the input source manually.

**On the TV:** The video from the playback device is displayed.

- ⑥ Check that the unit is properly synchronized with the TV by turning off the TV or adjusting the TV volume with the TV remote control.

This completes the necessary settings.

If you select a TV program with the TV remote control, the input source of the unit will be automatically switched to "AV 4" and the TV audio will be played back on the unit.

If you cannot hear the TV's audio, check that "ARC" (p.75) in the "Setup" menu is set to "On".



- If HDMI Control does not work properly, try turning off and on (or unplugging and then plugging in again) the devices. It may solve the problem.
- If the unit is not synchronized to the TV's power operations, check the priority of the audio output setting on the TV.
- If the audio is interrupted while using ARC, set "ARC" (p.75) in the "Setup" menu to "Off" and use a digital optical cable to input TV audio to the unit (p.20).



- "AV 4" is set as TV audio input at the factory. If you have connected any external device to the AV 4 jacks, use "TV Audio Input" (p.74) in the "Setup" menu to change the TV audio input assignment. To use the SCENE function (p.36), you also need to change the input assignment for SCENE(TV).

## ■ Connection Method 2 (HDMI Control-compatible TV)

Connect the TV to the unit with an HDMI cable and a digital optical cable.



- The following explanation is based on the assumption that you have not changed the “HDMI” parameters (p.74) in the “Setup” menu.

The unit (rear)    HDMI OUT jack

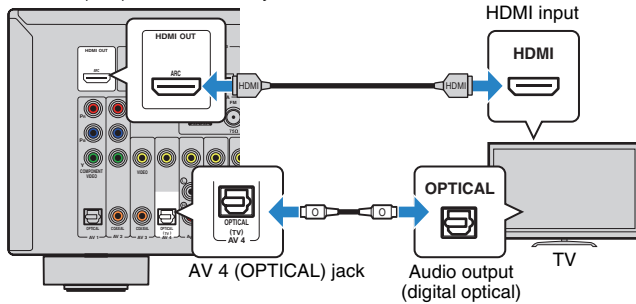

- By connecting a TV to the unit with an HDMI cable, you can navigate the iPod, USB storage device and network sources, or configure the settings of the unit with the menu displayed on the TV.

## □ Necessary settings

To use HDMI Control, you need to configure the following settings.

For details on settings and operating your TV, refer to the instruction manual for the TV.

### 1 After connecting external devices (such as a TV and playback devices) and power cable of the unit, turn on the unit, TV, and playback devices.

### 2 Configure the settings of the unit.

- Switch the TV input to display video from the unit.
- Press SETUP.

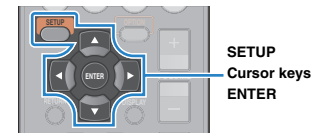

- Use the cursor keys to select “HDMI” and press ENTER.

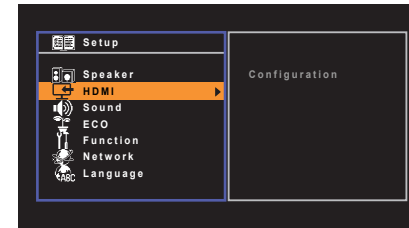

- Press ENTER again.
- Use the cursor keys ( $\Delta/\nabla$ ) to select “HDMI Control” and the cursor keys ( $\leftarrow/\rightarrow$ ) to select “On” as shown below.

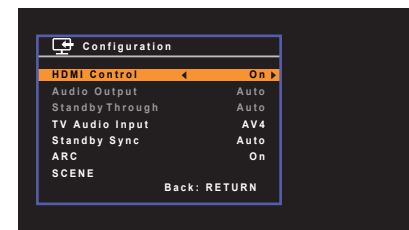

- Press SETUP.

### 3 Configure the settings for HDMI Control.

- ① Enable HDMI Control on the TV and playback devices (such as a HDMI Control-compatible BD/DVD player).
- ② Turn off the TV's main power and then turn off the unit and playback devices.
- ③ Turn on the unit and playback devices and then turn on the TV.
- ④ Switch the TV input to display video from the unit.
- ⑤ Check the following.
  - On the unit:** The input to which the playback device is connected is selected. If not, select the input source manually.
  - On the TV:** The video from the playback device is displayed.
- ⑥ Check that the unit is properly synchronized with the TV by turning off the TV or adjusting the TV volume with the TV remote control.

This completes the necessary settings.

If you select a TV program with the TV remote control, the input source of the unit will be automatically switched to "AV 4" and the TV audio will be played back on the unit.



- If HDMI Control does not work properly, try turning off and on (or unplugging and then plugging in again) the devices. It may solve the problem.
- If the unit is not synchronized to the TV's power operations, check the priority of the audio output setting on the TV.



- "AV 4" is set as TV audio input at the factory. If you have connected any external device to the AV 4 jacks or if you want to use another input jack (other than OPTICAL) for connecting the TV, use "TV Audio Input" (p.74) in the "Setup" menu to change the TV audio input assignment. To use the SCENE function (p.36), you also need to change the input assignment for SCENE(TV).

### ■ Connection Method 3 (TV with HDMI input jacks)

Connect the TV to the unit with an HDMI cable and a digital optical cable.

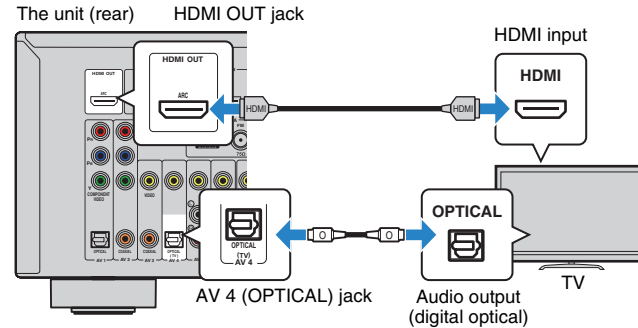

If you switch the input source of the unit to "AV 4" using the AV 4 or SCENE(TV) keys, the TV audio will be played back on the unit.



- By connecting a TV to the unit with an HDMI cable, you can navigate the iPod, USB storage device and network sources, or configure the settings of the unit with the menu displayed on the TV.
- If you have connected any external device to the AV 4 jacks or if you want to use another input jack (other than OPTICAL) for connecting the TV, connect the TV to one of the AV 1–6 and AUDIO jacks. To use the SCENE function (p.36), you also need to change the input assignment for SCENE(TV).

### ■ Connection Method 4 (TV without HDMI input jacks)

When connecting any video device to the AV 1–2 (COMPONENT VIDEO) jacks of the unit, connect the TV to the MONITOR OUT (COMPONENT VIDEO) jacks.

When connecting any video device to the AV 3–6 (VIDEO) jacks or the VIDEO AUX (VIDEO) jack of the unit, connect the TV to the MONITOR OUT (VIDEO) jack.

If you select “AV 4” as the input source by pressing AV 4 or SCENE(TV), the TV audio will be played back on the unit.



- If you connect your TV to the unit with a cable other than HDMI, video input to the unit via HDMI cannot be output to the TV.
- Operations with TV screen are available only when your TV is connected to the unit via HDMI.



- If you have connected any external device to the AV 4 jacks or if you want to use another input jack (other than OPTICAL) for connecting the TV, connect the TV to one of the AV 1–6 and AUDIO jacks. To use the SCENE function (p.36), you also need to change the input assignment for SCENE(TV).

### □ COMPONENT VIDEO connection (with a component video cable)

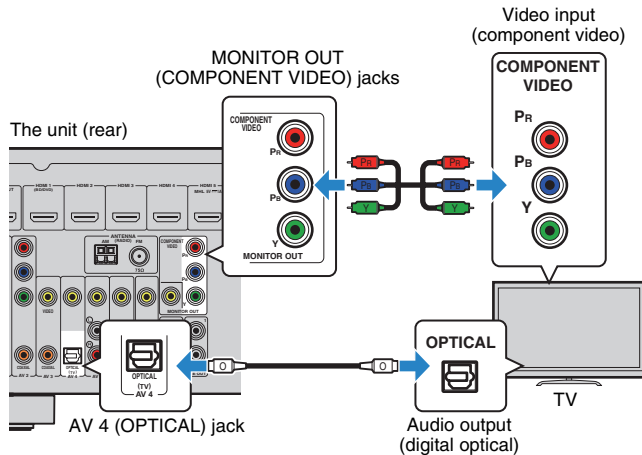

### □ VIDEO (composite video) connection (with a video pin cable)

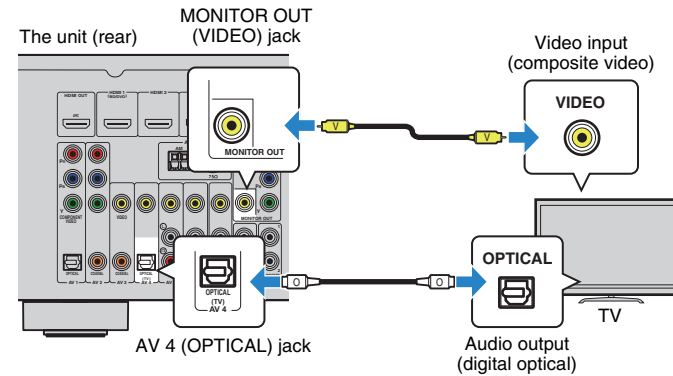

## 4 Connecting playback devices

The unit is equipped with a variety of input jacks including HDMI input jacks to allow you to connect different types of playback devices. For information on how to connect an iPod or a USB storage device, see the following pages.

- Connecting an iPod (p.47)
- Connecting a USB storage device (p.51)

### Connecting video devices (such as BD/DVD players)

Connect video devices such as BD/DVD players, set-top boxes (STBs) and game consoles to the unit. Depending on the video/audio output jacks available on your video device, choose one of the following connections. We recommend using an HDMI connection if the video device has an HDMI output jack.



- If the combination of video/audio input jacks available on the unit does not match your video device, change its combination according to the output jacks of your device (p.25).

#### HDMI connection

Connect a video device to the unit with an HDMI cable.

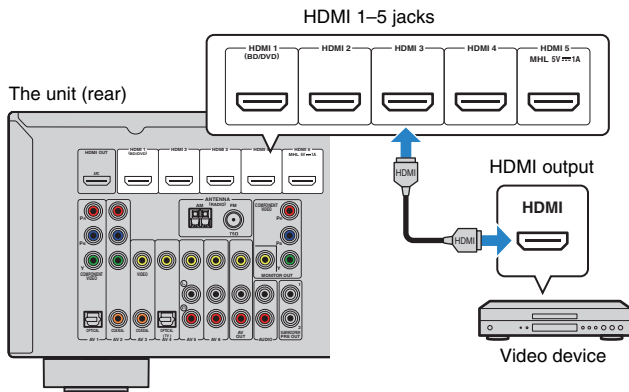

If you select the input source by pressing HDMI 1–5, the video/audio played back on the video device will be output from the unit.



- To watch videos input to the HDMI 1–5 jacks, you need to connect your TV to the HDMI OUT jack of the unit (p.18 to 21).

#### MHL connection

Connect an MHL-compatible mobile device (such as smartphones) to the unit with an MHL cable. You can enjoy full HD videos and multichannel audio sources stored on the mobile device. The HDMI 5 jack of the unit enables you to input videos and audio directly from the mobile device to the unit.

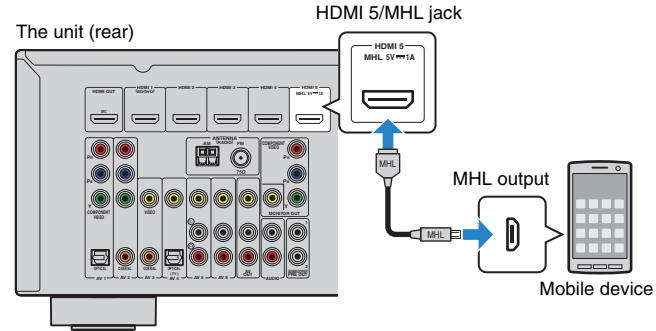

If you select the input source by pressing HDMI 5, the video/audio played back on the mobile device will be output from the unit.



- To watch videos input to the HDMI 5/MHL jack, you need to connect your TV to the HDMI OUT jack of the unit (p.18 to 21).
- You need to prepare an MHL cable that match the jack on your mobile device.



- You can operate the mobile device using the menu operation keys, external device operation keys and numeric keys on the remote control. However, some features may not be compatible, depending on the mobile device or its application. In this case, operate the mobile device itself.
- If “Standby Through” (p.74) in the “Setup” menu is set to “On”, you can output mobile device videos/audio to the TV or operate the mobile device using the remote control of the unit even when the unit is in standby mode.
- The unit supplies power to the mobile device in the following conditions.
  - The unit is turned on.
  - The unit is in standby mode while “Standby Through” (p.74) in the “Setup” menu is set to “On”.

## ■ Component video connection

Connect a video device to the unit with a component video cable and an audio cable (digital optical or digital coaxial). Choose a set of input jacks (on the unit) depending on the audio output jacks available on your video device.

Output jacks on video device		Input jacks on the unit
Video	Audio	
Component video	Digital optical	AV 1 (COMPONENT VIDEO + OPTICAL)
	Digital coaxial	AV 2 (COMPONENT VIDEO + COAXIAL)

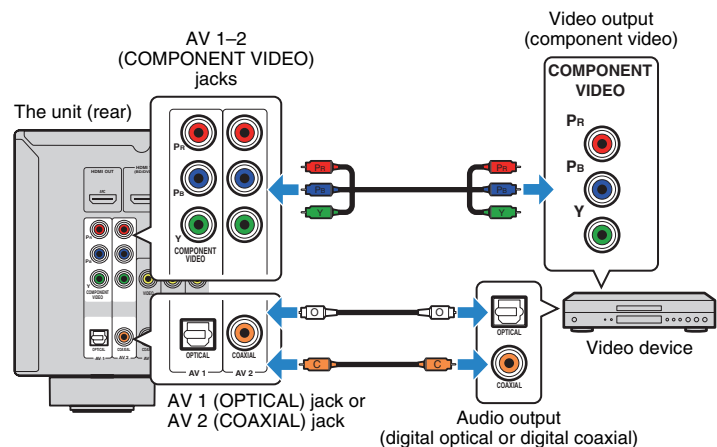

If you select the input source by pressing AV 1-2, the video/audio played back on the video device will be output from the unit.



- To watch videos input to the AV 1-2 (COMPONENT VIDEO) jacks, you need to connect your TV to the MONITOR OUT (COMPONENT VIDEO) jacks of the unit (p.22).

## ■ Composite video connection

Connect a video device to the unit with a video pin cable and an audio cable (digital coaxial, digital optical, or stereo pin cable). Choose a set of input jacks (on the unit) depending on the audio output jacks available on your video device.

Output jacks on video device		Input jacks on the unit
Video	Audio	
Composite video	Digital coaxial	AV 3 (VIDEO + COAXIAL)
	Digital optical	AV 4 (VIDEO + OPTICAL)
	Analog stereo	AV 5-6 (VIDEO + AUDIO)

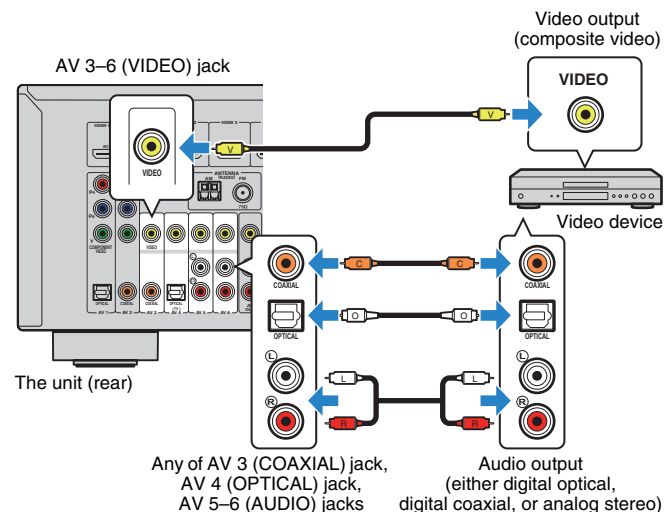

If you select the input source by pressing AV 3-6, the video/audio played back on the video device will be output from the unit.



- To watch videos input to the AV 3-6 (VIDEO) jacks, you need to connect your TV to the MONITOR OUT (VIDEO) jack of the unit (p.22).



## ■ Changing the combination of video/audio input jacks

If the combination of video/audio input jacks available on the unit does not match your video device, change its combination according to the output jacks of your device. You can connect a video device that has the following video/audio output jacks.

Output jacks on video device		Input jacks on the unit	
Video	Audio	Video	Audio
HDMI	Digital optical	HDMI 1-5	AV 1 (OPTICAL) AV 4 (OPTICAL)
	Digital coaxial	HDMI 1-5	AV 2-3 (COAXIAL)
	Analog stereo	HDMI 1-5	AV 5-6 (AUDIO) AUDIO
Component video	Analog stereo	AV 1-2 (COMPONENT VIDEO)	AV 5-6 (AUDIO) AUDIO

### □ Necessary setting

For example, if you have connected a video device to AV 2 (COMPONENT VIDEO) and AV 5 (AUDIO) jacks of the unit, change the combination setting as follows.

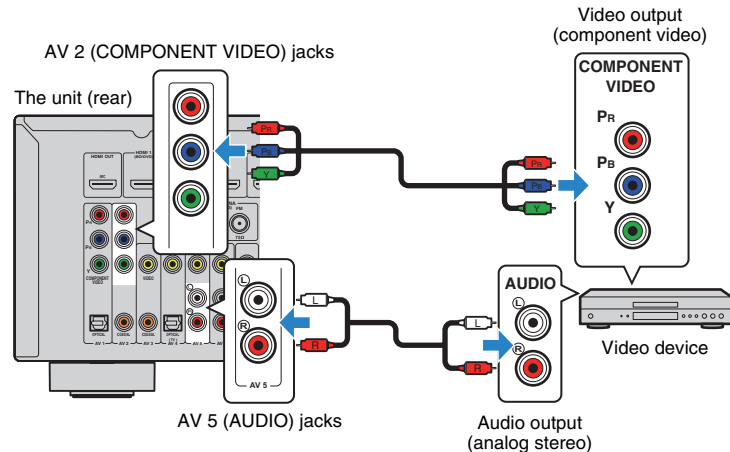

- 1 After connecting external devices (such as a TV and playback devices) and power cable of the unit, turn on the unit.
- 2 Press AV 2 to select “AV 2” (video input jack to be used) as the input source.

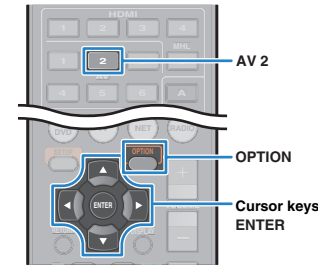

- 3 Press OPTION.
- 4 Use the cursor keys (Δ/▽) to select “Audio In” and press ENTER.



- 5 Use the cursor keys (</>) to select “AV 5” (audio input jack to be used).



- 6 Press OPTION.

This completes the necessary settings.

If you select “AV 2” as the input source by pressing AV 2, the video/audio played back on the video device will be output from the unit.

## Connecting audio devices (such as CD players)

Connect audio devices such as CD players and MD players to the unit. Depending on the audio output jacks available on your audio device, choose one of the following connections.

Audio output jacks on audio device	Audio output jacks on the unit
Digital optical	AV 1 (OPTICAL) AV 4 (OPTICAL)
Digital coaxial	AV 2-3 (COAXIAL)
Analog stereo	AV 5-6 (AUDIO) AUDIO

The unit (rear)

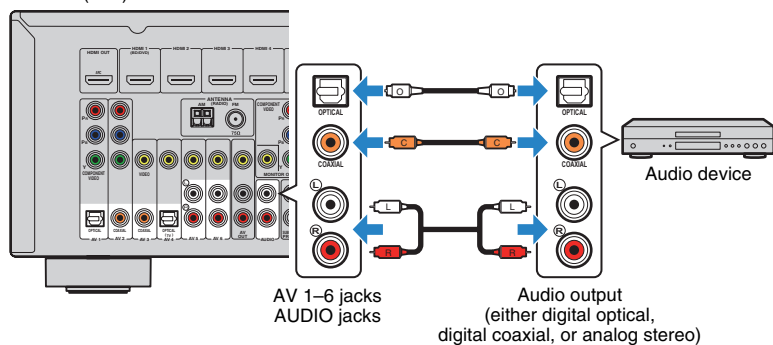

If you select the input source by pressing AV 1-6 or AUDIO, the audio played back on the audio device will be output from the unit.

## Connecting to the jacks on the front panel

Use the VIDEO AUX jacks on the front panel to temporarily connect devices such as camcorders and portable audio players to the unit.

Before making a connection, stop playback on the device and turn down the volume on the unit.

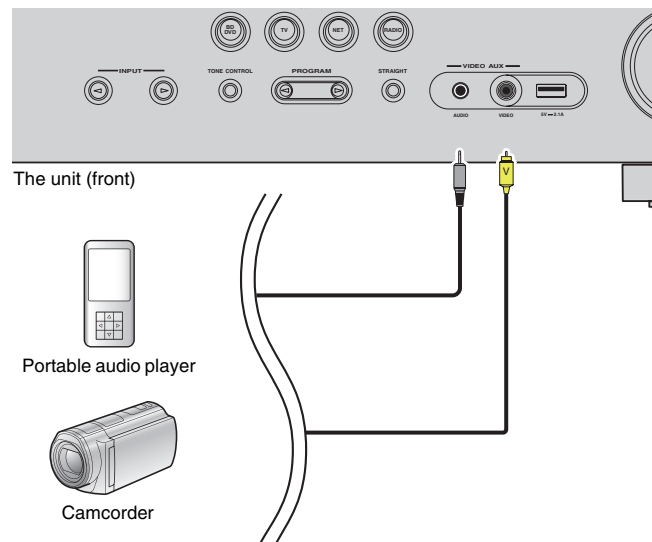

If you select "V-AUX" as the input source by pressing V-AUX, the video/audio played back on the device will be output from the unit.



- To watch videos input to the VIDEO AUX (VIDEO) jack, you need to connect your TV to the MONITOR OUT (VIDEO) jack of the unit (p.22).
- You need to prepare the video/audio cables that match the output jacks on your device.



- For details on how to connect an iPod or a USB storage device, see "Connecting an iPod" (p.47) or "Connecting a USB storage device" (p.51).
- When "USB" is selected as the input source, video signals input to the VIDEO AUX (VIDEO) jack are output from the MONITOR OUT (VIDEO) jack.

## 5 Connecting the FM/AM antennas

Connect the supplied FM/AM antennas to the unit.  
 Fix the end of the FM antenna to a wall, and place the AM antenna on a flat surface.

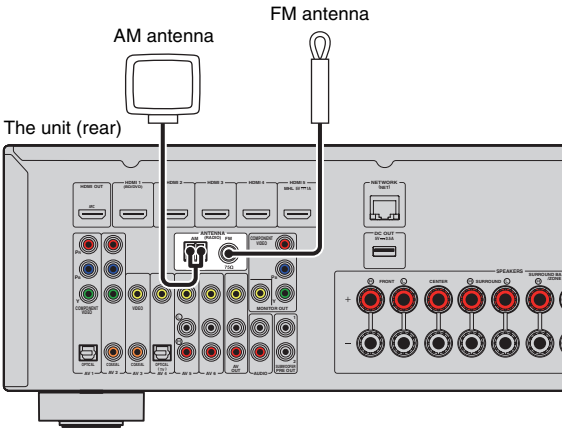

### Assembling and connecting the AM antenna

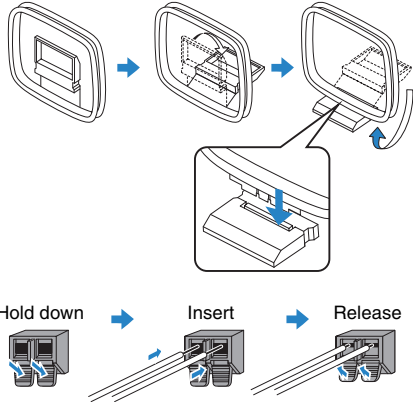

- Unwind only the length of cable needed from the AM antenna unit.
- The wires of the AM antenna have no polarity.

## 6 Connecting to a network

Connect the unit to your router with a commercially-available STP network cable (CAT-5 or higher straight cable).

You can enjoy Internet radio or music files stored on media servers, such as PCs and Network Attached Storage (NAS), on the unit.

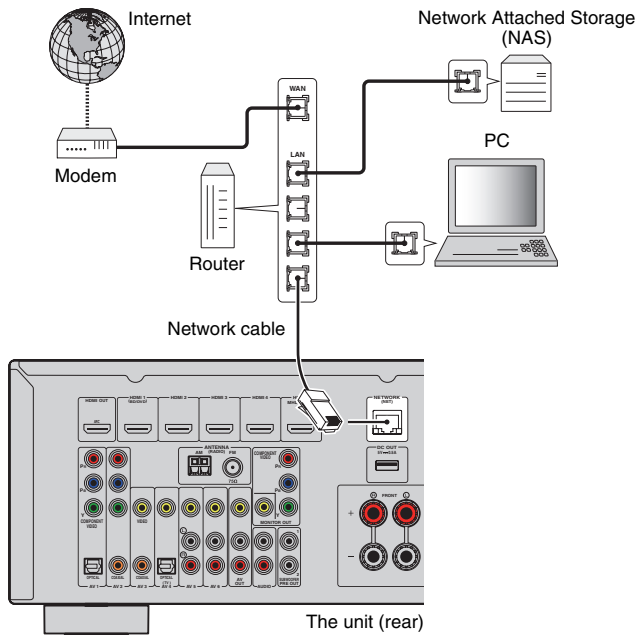

- If you are using a router that supports DHCP, you do not need to configure any network settings for the unit, as the network parameters (such as the IP address) will be assigned automatically to it. You only need to configure the network settings if your router does not support DHCP or if you want to configure the network parameters manually (p.80).
- You can check whether the network parameters (such as IP address) are properly assigned to the unit in "Information" (p.80) in the "Setup" menu.



- Some security software installed on your PC or the firewall settings of network devices (such as a router) may block the access of the unit to the network devices or the Internet. In these cases, configure the security software or firewall settings appropriately.
- Each server must be connected to the same subnet as the unit.
- To use the service via the Internet, broadband connection is strongly recommended.

## 7 Connecting recording devices

You can connect video/audio recording devices to the AV OUT jacks. These jacks output analog video/audio signals selected as the input.



- To copy video/audio from a video device, connect the video device to the AV 5–6 jacks or VIDEO AUX (VIDEO/AUDIO) jacks of the unit.
- To copy audio from an audio device, connect the audio device to the AV 5–6 jacks, AUDIO jacks, or VIDEO AUX (AUDIO) jacks of the unit.
- Be sure to use the AV OUT jacks only for connecting recording devices.

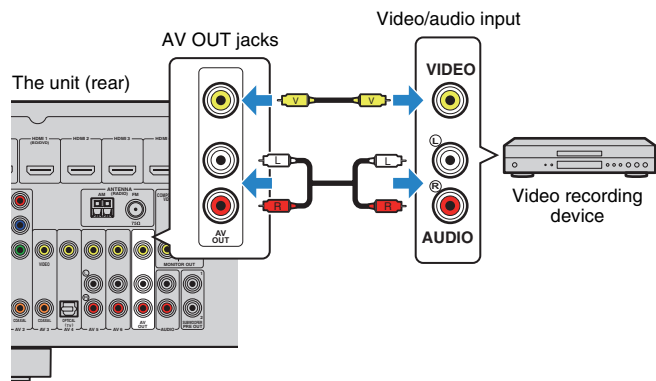

## 8 Connecting the power cable

### Before connecting the power cable (General model only)

Set the switch position of VOLTAGE SELECTOR according to your local voltage. Voltages are AC 110–120/220–240 V, 50/60 Hz.



- Make sure you set VOLTAGE SELECTOR of the unit BEFORE plugging the power cable into an AC wall outlet. Improper setting of VOLTAGE SELECTOR may cause damage to the unit and create a potential fire hazard.

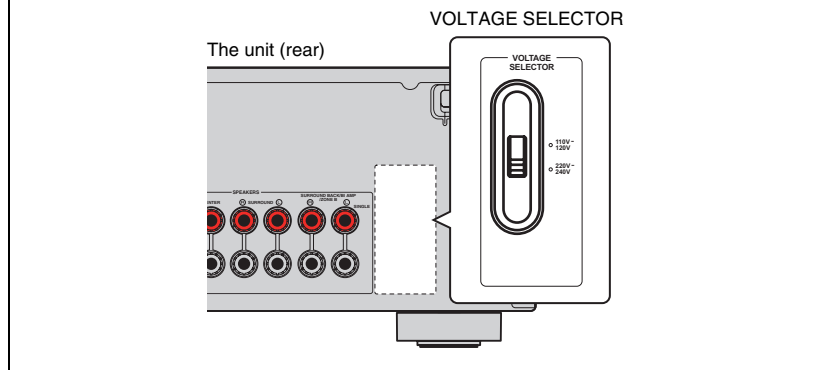

After all the connections are complete, plug in the power cable.

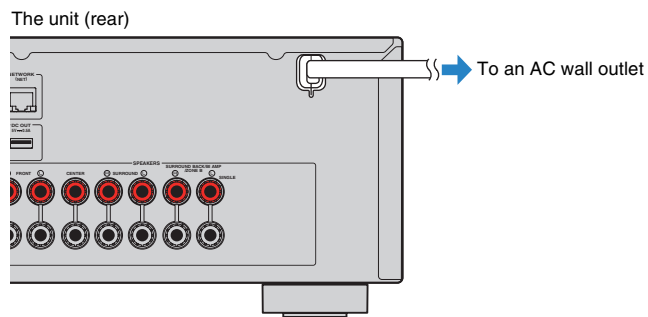

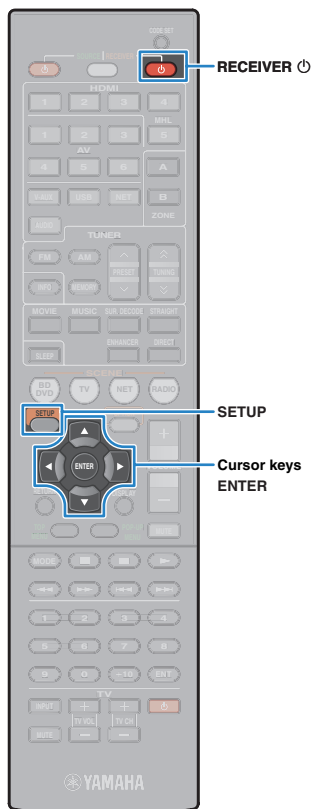

## 9 Selecting an on-screen menu language

Select the desired on-screen menu language from English (default), Japanese, French, German, Spanish, Russian, Italian and Chinese.

- 1 Press RECEIVER to turn on the unit.
  - 2 Turn on the TV and switch the TV input to display video from the unit (HDMI OUT jack).
- !**
- Operations with TV screen are available only when your TV is connected to the unit via HDMI. If not, carry out operations while viewing the front display.
- 3 Press SETUP.
  - 4 Use the cursor keys to select “Language” and press ENTER.



- 5 Use the cursor keys to select the desired language.



- 6 To exit from the menu, press SETUP.



- The information on the front display is provided in English only.

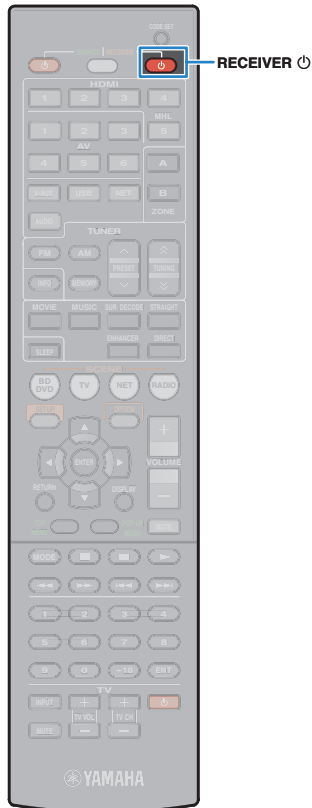

## 10 Optimizing the speaker settings automatically (YPAO)

The Yamaha Parametric room Acoustic Optimizer (YPAO) function detects speaker connections, measures the distances from them to your listening position(s), and then automatically optimizes the speaker settings, such as volume balance and acoustic parameters, to suit your room.



- Please note the following when using YPAO.
  - Use YPAO after connecting a TV and speakers to the unit.
  - During the measuring process, test tones are output at high volume. Ensure that the test tones do not frighten small children. Also, refrain from using this function at night when it may be a nuisance to others.
  - During the measuring process, you cannot adjust the volume.
  - During the measuring process, keep the room as quiet as possible.
  - Do not connect headphones.

**1** Press **RECEIVER** to turn on the unit.

**2** Turn on the TV and switch the TV input to display video from the unit (HDMI OUT jack).



- Operations with TV screen are available only when your TV is connected to the unit via HDMI. If not, carry out operations while viewing the front display.

**3** Turn on the subwoofer and set the volume to half. If the crossover frequency is adjustable, set it to maximum.

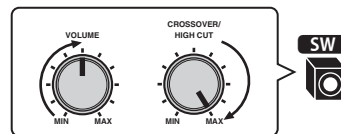

- (RX-V575 only)  
If you are using bi-amp connection or Zone B speakers, set "Power Amp Assign" (p.71) in the "Setup" menu to the appropriate setting before starting YPAO.

**4** Place the YPAO microphone at your listening position (same height as your ears) and connect it to the YPAO MIC jack on the front panel.

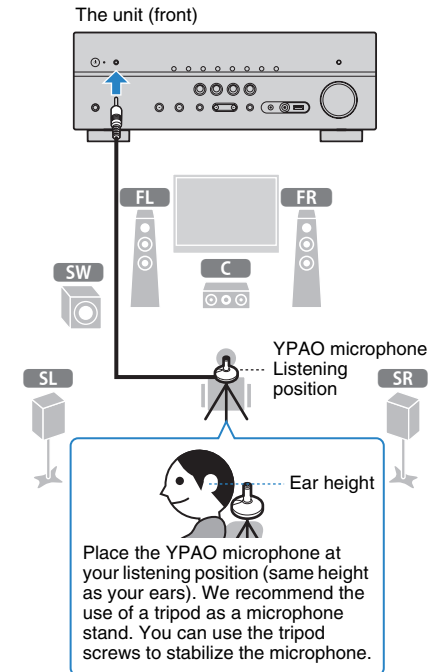

The following screen appears on the TV.

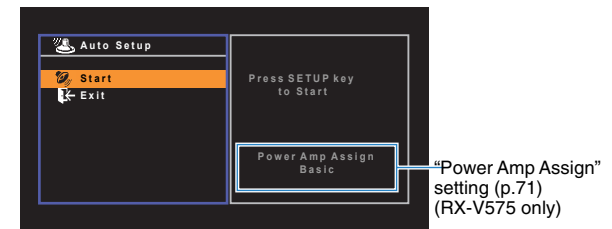

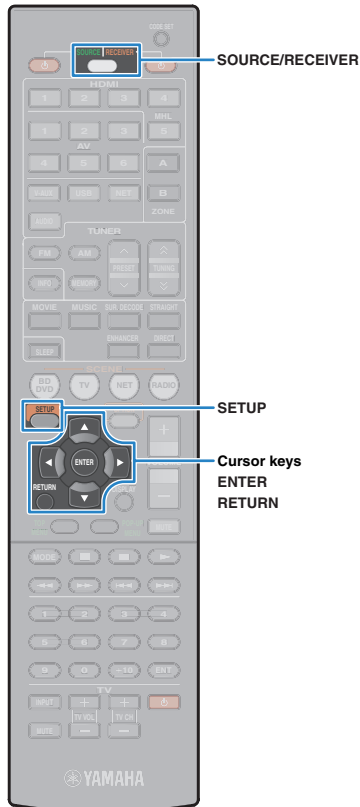

- To cancel the operation, disconnect the YPAO microphone, or use the cursor keys to select “Exit” and press ENTER, before starting the measurement.



- Do not stand between the speakers and the YPAO microphone during the measurement process (about 3 minutes).
- Move to the corner of the room or leave the room.

## 5 To start the measurement, use the cursor keys to select “Start” and press SETUP.

The measurement will start in 10 seconds. Press ENTER to start the measurement immediately.



- To stop the measurement temporarily, press RETURN and follow the procedure in “Error messages” (p.33).
- If cursor keys do not work, the remote control may be set to the external device operation mode. In this case, press SOURCE/RECEIVER to set the remote control to the unit operation mode (the key lights up in orange) and then use the cursor keys.

The following screen appears on the TV when the measurement finishes.

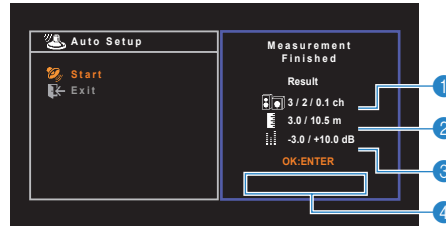

- 1 The number of speakers (front side/rear side/subwoofer)
- 2 Speaker distance (nearest/farthest)
- 3 Adjustment range of speaker output level
- 4 Warning message (if available)



- If any error message (such as E-1) or warning message (such as W-1) appears, see “Error messages” (p.33) or “Warning messages” (p.34).



- A speaker with a problem is indicated by blinking of the speaker indicators in the front display.
- If multiple warnings are given (when operating with the front display), use the cursor keys ( $\triangle/\nabla$ ) to check the other warning messages.

## 6 To save the measurement results, use the cursor keys ( $\triangle/\nabla$ ) to select “SAVE” and press ENTER.

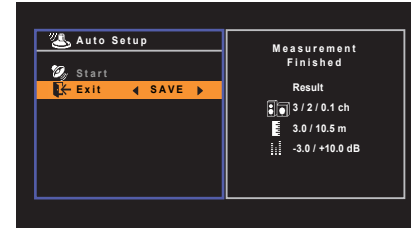

The adjusted speaker settings are applied.



- To finish the measurement without saving the result, select “CANCEL”.

## 7 Disconnect the YPAO microphone from the unit.

This completes optimization of the speaker settings.

### Caution

- The YPAO microphone is sensitive to heat, so should not be placed anywhere where it could be exposed to direct sunlight or high temperatures (such as on top of AV equipment).



## Error messages

If any error message is displayed during the measurement, resolve the problem and perform YPAO again.

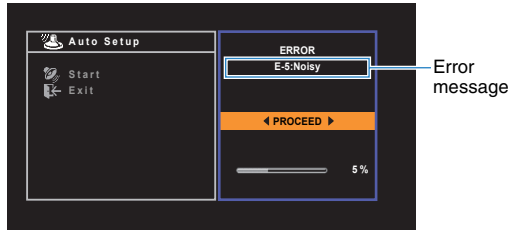

TV screen



Front display

### Procedure to handle errors

- 1 Check the content of error message and press ENTER.
- 2 Use the cursor keys (◀/▶) to select the desired operation.

#### To exit the YPAO measurement:

- ① Select "EXIT" and press ENTER.
- ② Use the cursor keys (▲/▼) to select "Exit" and press ENTER.
- ③ Disconnect the YPAO microphone from the unit.

#### To retry the YPAO measurement from beginning:

Select "RETRY" and press ENTER.

#### To proceed with the current YPAO measurement (for E-5 and E-9 only):

Select "PROCEED" and press ENTER.

Error message	Cause	Remedy
<b>E-1:No Front SP</b> (E-1:NO FRNT SP)	Front speakers are not detected.	Exit YPAO, turn off the unit, and then check the speaker connections.
<b>E-2:No Sur. SP</b> (E-2:NO SUR SP)	One of the surround speakers cannot be detected.	
<b>E-4:SBR → SBL</b> (E-4:SBR -> SBL)	A surround back speaker is connected to the R side only.	When using only one surround back speaker, you need to connect it to the SINGLE jack (L side). Exit YPAO, turn off the unit, and then reconnect the speaker.
<b>E-5:Noisy</b> (E-5:NOISY)	The noise is too loud.	Keep the room quiet and retry YPAO. If you select "PROCEED", YPAO takes the measurement again and ignores any noise detected.
<b>E-6:Check Sur.</b> (E-6:CHECK SUR)	Surround back speakers are connected, but no surround speakers are connected.	Surround speakers need to be connected in order to use surround back speakers. Exit YPAO, turn off the unit, and then reconnect the speakers.
<b>E-7:No MIC</b> (E-7:NO MIC)	The YPAO microphone has been removed.	Connect the YPAO microphone to the YPAO MIC jack firmly and retry YPAO.
<b>E-8:No Signal</b> (E-8:NO SIGNAL)	The YPAO microphone cannot detect test tones.	Connect the YPAO microphone to the YPAO MIC jack firmly and retry YPAO. If this error occurs repeatedly, contact the nearest authorized Yamaha dealer or service center.
<b>E-9:User Cancel</b> (E-9:CANCEL)	The measurement has been canceled.	Retry or exit YPAO as necessary.
<b>E-10:Internal Err.</b> (E-10:INTERNAL)	An internal error has occurred.	Exit YPAO, and turn off and on the unit. If this error occurs repeatedly, contact the nearest authorized Yamaha dealer or service center.



- Texts in parentheses denote indicators on the front display.

## Warning messages

If a warning message is displayed after the measurement, you can still save the measurement results by following on-screen instructions. However, we recommend you perform YPAO again in order to use the unit with the optimal speaker settings.

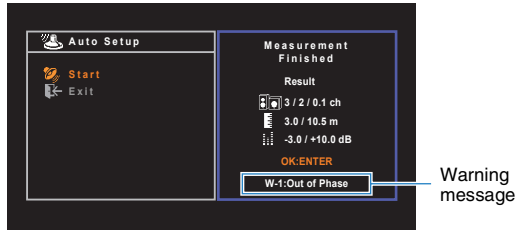

TV screen



Front display

Warning message	Cause	Remedy
<b>W-1: Out of Phase (W-1:PHASE)</b>	A speaker cable may be connected with the reverse polarity (+/-).	Check the cable connections (+/-) of the problem speaker. If the speaker is connected incorrectly, exit YPAO, turn off the unit, and then reconnect the speaker cable. Depending on the type of speakers or room environment, this message may appear even if the speakers are connected correctly. In this case, you can ignore the message.
<b>W-2: Over Distance (W-2:DISTANCE)</b>	A speaker is placed more than 24 m (80 ft) from the listening position.	Exit YPAO, turn off the unit, and place the problem speaker within 24 m (80 ft) of the listening position.
<b>W-3: Level Error (W-3:LEVEL)</b>	There are significant volume differences between the speakers.	Check the usage environment and cable connections (+/-) of each speaker, and the volume of the subwoofer. If there is any problem, exit YPAO, turn off the unit, and then reconnect speaker cable or correct the speaker positions. We recommend using the same speakers or speakers with specifications that are as similar as possible.



- Texts in parentheses denote indicators on the front display.

## Procedure to handle warnings

**1 Check the content of warning message and press ENTER.**

**2 Use the cursor keys (</>) to select the desired operation.**

**To save the measurement results:**

Select "SAVE" and press ENTER.

**To discard the measurement result:**

Select "CANCEL" and press ENTER.

**3 Disconnect the YPAO microphone from the unit.**

# PLAYBACK

## Basic playback procedure

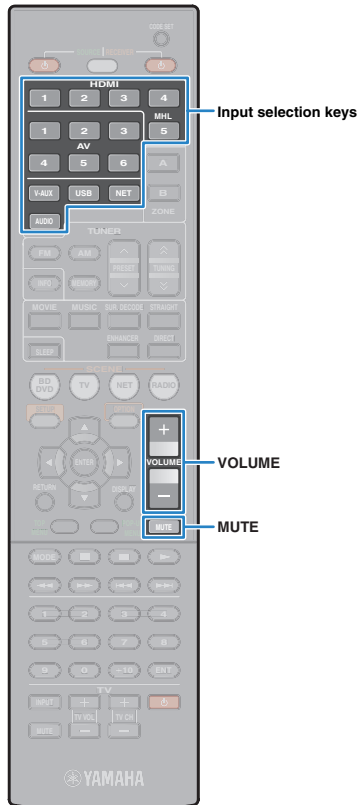

- 1 Turn on the external devices (such as a TV or BD/DVD player) connected to the unit.**
- 2 Use the input selection keys to select an input source.**
- 3 Start playback on the external device or select a radio station.**

Refer to the instruction manual for the external device.

For details on the following operations, see the corresponding pages.

- Listening to FM/AM radio (p.43)
- Playing back iPod music (p.47)
- Playing back music stored on a USB storage device (p.51)
- Playing back music stored on media servers (PCs/NAS) (p.54)
- Listening to Internet radio (p.57)
- Playing back iTunes/iPod music via a network (AirPlay) (p.59)

- 4 Press VOLUME to adjust the volume.**



- To mute the audio output, press MUTE. Press MUTE again to unmute.
- To adjust the treble/bass settings, use the “Option” menu or TONE CONTROL on the front panel (p.65).

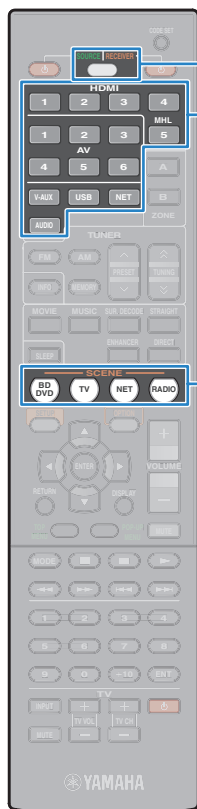

SOURCE/RECEIVER

Input selection keys

SCENE

## Selecting the input source and favorite settings with one touch (SCENE)

The SCENE function allows you to select the assigned input source, sound program, Compressed Music Enhancer on/off, and target zones (RX-V575 only) with just one touch.

### 1 Press SCENE.

The input source and settings registered to the corresponding scene are selected. The unit turns on automatically when it is in standby mode.

By default, the following settings are registered for each scene.

SCENE	Input	Sound program	Compressed Music Enhancer	Target zone (RX-V575 only)	SCENE link playback
BD/DVD	HDMI 1	MOVIE (Sci-Fi)	Off	Zone A: enabled Zone B: disabled	On
TV	AV 4	STRAIGHT	On	Zone A: enabled Zone B: disabled	On
NET	NET RADIO	MUSIC (7ch/5ch Stereo*)	On	Zone A: enabled Zone B: disabled	Off
RADIO	TUNER	MUSIC (7ch/5ch Stereo*)	On	Zone A: enabled Zone B: disabled	Off

\* RX-V575: 7ch Stereo, RX-V475: 5ch Stereo



- The SCENE link playback function allows you to automatically turn on the TV or start playback of an external device connected to the unit via HDMI, in conjunction with a scene selection. To enable SCENE link playback, set "SCENE" (p.75) in the "Setup" menu to "On".

## Configuring scene assignments

### 1 Perform the following operations to prepare the settings you want to assign to a scene.

- Select an input source (p.35)
- Select a sound program (p.37)
- Enable/disable Compressed Music Enhancer (p.42)
- (RX-V575 only)  
Enable/disable the audio output to Zone A/B (p.62)

### 2 Hold down the desired SCENE key until "SET Complete" appears on the front display.



### 3 If you want to control the corresponding playback device after selecting the scene, hold down the corresponding SCENE key and input selection key together for more than 3 seconds.

Once the setting is completed successfully, SOURCE/RECEIVER blinks twice.



- If you have not registered the remote control code of the playback device yet, see "Registering the remote control codes for playback devices" (p.86) to register it.

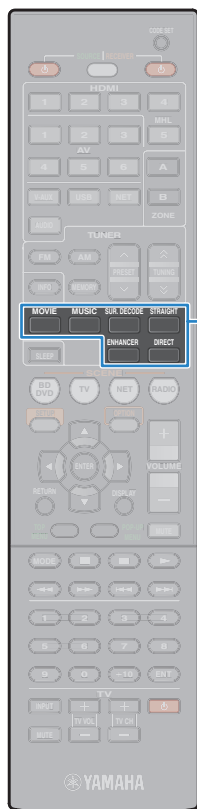

MOVIE  
MUSIC  
SUR.DECODE  
STRAIGHT  
DIRECT  
ENHANCER

## Selecting the sound mode

The unit is equipped with a variety of sound programs and surround decoders that allow you to enjoy playback sources with your favorite sound mode (such as sound field effect or stereo playback).

### ❑ Selecting a sound program suitable for movies

- Press MOVIE repeatedly.

This mode lets you enjoy sound field effects optimized for viewing video sources, such as movies, TV programs, and games (p.38).

### ❑ Selecting a sound program suitable for music or stereo playback

- Press MUSIC repeatedly.

This mode lets you enjoy sound field effects optimized for listening music sources or stereo playback (p.39).

### ❑ Selecting a surround decoder

- Press SUR.DECODE repeatedly.

This mode lets you enjoy unprocessed multichannel playback from 2-channel sources (p.41).

### ❑ Switching to the straight decode mode

- Press STRAIGHT.

This mode lets you enjoy unprocessed sounds in original channels (p.40).

### ❑ Switching to the direct playback mode

- Press DIRECT.

This mode lets you enjoy pure high fidelity sound by reducing the electrical noise from other circuitry (p.41).

### ❑ Enabling Compressed Music Enhancer

- Press ENHANCER.

This mode lets you enjoy compressed music with additional depth and breadth (p.42).



- You can also switch the sound programs and surround decoder by pressing PROGRAM on the front panel.
- The sound mode can be applied separately to each input source.
- When you play back audio signals with a sampling rate of higher than 96 kHz or playing back DTS Express, the straight decode mode (p.40) is automatically selected.
- You can check which speakers are currently outputting sound by looking at the speaker indicators on the unit's front panel (p.8).

## Enjoying sound field effects (CINEMA DSP)

### CINEMA DSP

The unit is equipped with a variety of sound programs that utilize Yamaha's original DSP technology (CINEMA DSP). It allows you to easily create sound fields like actual movie theaters or concert halls in your room.

Sound program category

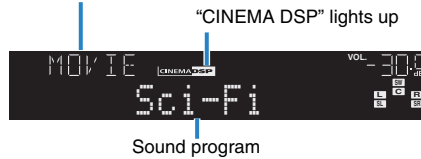

- When you play back DTS-HD sources, the DTS decoder is automatically selected.



- You can adjust the sound field effect level in "DSP Level" (p.65) in the "Option" menu.

### ■ Sound programs suitable for movies (MOVIE)

The following sound programs are optimized for viewing video sources, such as movies, TV programs, and games.

<b>Standard</b>	This program creates a sound field that emphasizes the surround feeling without disturbing the original acoustic positioning of multichannel audio, such as Dolby Digital and DTS. Its design is based on the concept of the ideal movie theater, in which the audience is surrounded by beautiful reverberations from the left, right, and rear.
<b>Spectacle</b>	This program delivers the scale and grandeur of spectacular movie productions. It delivers an expansive sound space to match the cinemascope wide-screen, and boasts a broad dynamic range, providing everything from small delicate sounds to powerful loud booms.
<b>Sci-Fi</b>	This program clearly reproduces the finely elaborated sound design of the latest Sci-Fi and SFX movies. You can enjoy a variety of cinematographically created virtual spaces reproduced with clear separation between dialogue, sound effects, and background music.
<b>Adventure</b>	This program is ideal for reproducing the sound design of action and adventure movies precisely. The sound field restrains reverberations, but puts emphasis on reproducing a sensation of expansiveness on both sides, powerful space expanded widely to the left and right. The restrained depth creates a clear and powerful space, while also maintaining the articulation of the sounds and the separation of the channels.

<b>Drama</b>	This program features stable reverberations that match a wide range of movie genres, from serious dramas to musicals and comedies. The reverberations are modest, but suitably stereophonic. The sound effects and background music are reproduced with a gentle echo that does not impinge on the articulation of the dialogue. You'll never get tired listening for long periods.
<b>Mono Movie</b>	This program reproduces monaural video sources, such as classic movies, in an atmosphere of a good old movie theater. The program creates a pleasant space with depth, by adding breadth and the appropriate reverberation to the original audio.
<b>Sports</b>	This program allows listeners to enjoy the rich vividness of sport broadcasts and light entertainment programs. In sports broadcasts, the commentators' voices are positioned clearly at the center, while the atmosphere inside the stadium is realistically conveyed by the peripheral delivery of the sounds of the fans in a suitable space.
<b>Action Game</b>	This program is suitable for action games, such as car racing and fighting games. The reality of, and emphasis on, various effects makes the player feel like they are right in the middle of the action, allowing for greater concentration. Use this program in combination with Compressed Music Enhancer for a more dynamic and strong sound field.
<b>Roleplaying Game</b>	This program is suitable for role-playing and adventure games. This program adds depth to the sound field for natural and realistic reproduction of background music, special effects, and dialogue from a wide variety of scenes. Use this program in combination with Compressed Music Enhancer for a clearer and more spatial sound field.

## ■ Sound programs suitable for music/stereo playback (MUSIC)

The following sound programs are optimized for listening to music sources.

You can also select stereo playback.

<b>Hall in Munich</b>	This program simulates a Munich concert hall with approximately 2,500 seats that uses stylish wood for the interior finishing. Fine, beautiful reverberations spread richly, creating a calming atmosphere. The listener's virtual seat is at the center left of the arena.
<b>Hall in Vienna</b>	This program simulates a 1700-seat, middle-sized concert hall with a shoebox shape that is traditional in Vienna. Pillars and ornate carvings create extremely complex reverberations from all around the audience, producing a very full, rich sound.
<b>Chamber</b>	This program creates a relatively wide space with a high ceiling, like an audience hall in a palace. It offers pleasant reverberations that are suitable for courtly music and chamber music.
<b>Cellar Club</b>	This program simulates an intimate concert venue with a low ceiling and homey atmosphere. A realistic, live sound field delivers powerful sounds that make you feel as if you are sitting in the front row in front of a small stage.
<b>The Roxy Theatre</b>	This program creates the sound field of a 460-seat rock music concert venue in Los Angeles. The listener's virtual seat is at the center left of the hall.
<b>The Bottom Line</b>	This program creates the sound field at stage front in The Bottom Line, a famous New York jazz club once. The floor can seat 300 people to the left and right in a sound field offering real and vibrant sound.
<b>Music Video</b>	This program allows you to enjoy videos of pop, rock, and jazz concerts, as if you were there yourself. Immerse yourself in the hot concert atmosphere thanks to the vividness of the singers and solos on stage, a presence sound field that emphasizes the beat of rhythm instruments, and a surround sound field that reproduces the space of a big live hall.
<b>2ch Stereo</b>	Use this program to mix down multichannel sources to 2 channels. When multichannel signals are input, they are down mixed to 2 channels and output from the front speakers (this program does not utilize CINEMA DSP).
<b>7ch Stereo 5ch Stereo</b>	(RX-V575: 7ch Stereo, RX-V475: 5ch Stereo) Use this program to output sound from all speakers. When you play back multichannel sources, the unit mixes down the source to 2 channels, and then outputs the sound from all speakers. This program creates a larger sound field and is ideal for background music at parties.



STRAIGHT

## ■ Enjoying stereoscopic sound fields (CINEMA DSP 3D)



CINEMA DSP 3D creates a natural stereoscopic sound field in your room.

CINEMA DSP 3D functions when both of the following conditions are met.

- One of the sound programs (except 2ch Stereo and 7ch/5ch Stereo) is selected (p.38).
- "CINEMA DSP 3D Mode" (p.75) in the "Setup" menu is set to "On".

"CINEMA DSP 3D" lights up



## ■ Enjoying sound field effects without surround speakers (Virtual CINEMA DSP)

If you select one of the sound programs (except 2ch Stereo and 7ch/5ch Stereo) when no surround speakers are connected, the unit automatically creates the surround sound field using the front-side speakers.

## Enjoying unprocessed playback

You can play back input sources without any sound field effect processing.

### ■ Playing back in original channels (straight decode)

When the straight decode mode is enabled, the unit produces stereo sound from the front speakers for 2-channel sources such as CDs, and produces unprocessed multichannel sounds for multichannel sources.

#### 1 Press STRAIGHT.

Each time you press the key, the straight decode mode is enabled or disabled.



- (RX-V575 only)  
To enable 6.1/7.1-channel playback from 5.1-channel sources when surround back speakers are used, set "Extended Surround" (p.65) in the "Option" menu to a setting other than "Off".



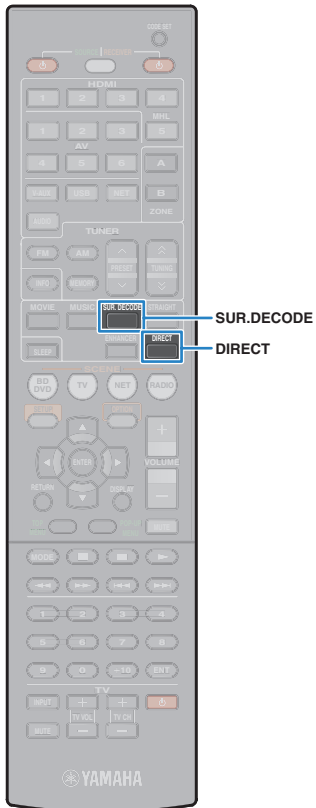

## ■ Playing back 2-channel sources in multichannel (surround decoder)

The surround decoder enables unprocessed multichannel playback from 2-channel sources. When a multichannel source is input, it works the same way as the straight decode mode.

For details on each decoder see “Glossary” (p.97).

### 1 Press SUR.DECODE to select a surround decoder.

Each time you press the key, the surround decoder changes.



<b>Dolby Pro Logic</b>	Uses the Dolby Pro Logic decoder suitable for all sources.
<b>Dolby PLII Movie</b>	Use the Dolby Pro Logic II decoder (or Dolby Pro Logic IIx decoder) suitable for movies.
<b>Dolby PLIIx Movie*</b>	
<b>Dolby PLII Music</b>	Use the Dolby Pro Logic II decoder (or Dolby Pro Logic IIx decoder) suitable for music.
<b>Dolby PLIIx Music*</b>	
<b>Dolby PLII Game</b>	Use the Dolby Pro Logic II decoder (or Dolby Pro Logic IIx decoder) suitable for games.
<b>Dolby PLIIx Game*</b>	
<b>Neo: 6 Cinema</b>	Uses the DTS Neo: 6 decoder suitable for movies.
<b>Neo: 6 Music</b>	Uses the DTS Neo: 6 decoder suitable for music.

\* RX-V575 only



(RX-V575 only)

- You cannot select the Dolby Pro Logic IIx decoders when headphones are connected or when “Surround Back” in the “Setup” menu is set to “None”.



- You can adjust the surround decoder parameters in “DSP Parameter” (p.75) in the “Setup” menu.

## Enjoying pure high fidelity sound (direct playback)

When the direct playback mode is enabled, the unit plays back the selected source with the least circuitry in order to reduce the electrical noise from other circuitry (such as the front display). It allows you to enjoy Hi-Fi sound quality.

### 1 Press DIRECT.

Each time you press the key, the direct playback mode is enabled or disabled.



- When the direct playback mode is enabled, the following functions are not available.
  - Selecting sound programs
  - Adjusting the tone control
  - Operating the on-screen and “Option” menus
  - Viewing information on the front display (when not in operation)

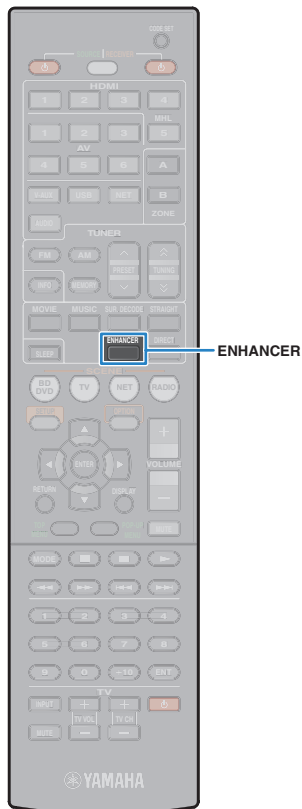

## Enjoying compressed music with enhanced sound (Compressed Music Enhancer)

### compressed music **ENHANCER**

Compressed Music Enhancer adds depth and breadth to the sound, allowing you to enjoy a dynamic sound close to the original sound before it was compressed. This function can be used along with any other sound modes.

#### 1 Press ENHANCER.

Each time you press the key, Compressed Music Enhancer is enabled or disabled.

“ENHANCER” lights up



- Compressed Music Enhancer does not work on the following audio sources.
  - Signals whose sampling rate is over 48 kHz
  - High-definition streaming audio



- You can also use “Enhancer” (p.66) in the “Option” menu to enable/disable Compressed Music Enhancer.

## Enjoying surround sound with headphones (SILENT CINEMA)



You can enjoy surround or sound field effects, like a multichannel speaker system, with stereo headphones by connecting the headphones to the PHONES jack and selecting a sound program or a surround decoder.

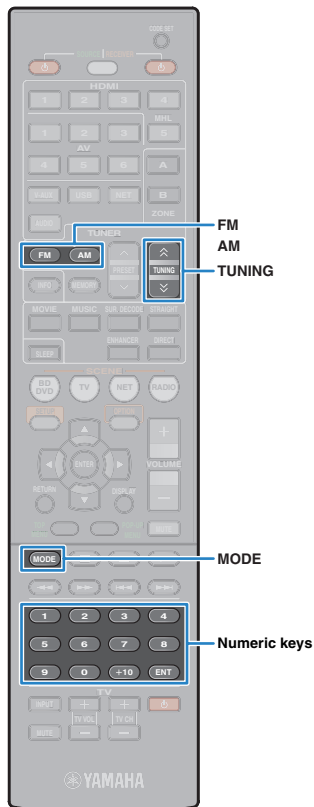

## Listening to FM/AM radio

You can tune into a radio station by specifying its frequency or selecting from registered radio stations.



- The radio frequencies differ depending on the country or region where the unit is being used. The explanation of this section uses a display with frequencies used in U.K. and Europe models.
- If you cannot obtain good reception on the radio, adjust the direction of the FM/AM antennas.

## Setting the frequency steps

(Asia and General models only)

At the factory, the frequency step setting is set to 50 kHz for FM and 9 kHz for AM. Depending on your country or region, set the frequency steps to 100 kHz for FM and 10 kHz for AM.

- 1 Set the unit to standby mode.
- 2 When holding down **STRAIGHT** on the front panel, press **⏻** (power).

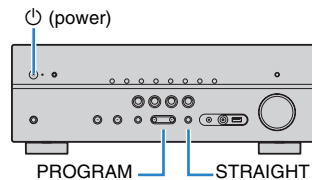

- 3 Press **PROGRAM** repeatedly to select “TU”.



- 4 Press **STRAIGHT** to select “FM100/AM10”.
- 5 Press **⏻** (power) to set the unit to standby mode and turn it on again.

## Selecting a frequency for reception

- 1 Press **FM** or **AM** to select a band.



- 2 Use the following keys to set a frequency.

**TUNING:** Increase/decrease the frequency. Hold down the key for about a second to search stations automatically.

**Numeric keys:** Enter a frequency directly. For example, to select 98.50 MHz, press “9”, “8”, “5” and “0” (or ENT).

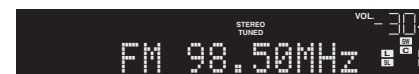

“TUNED” lights up when a signal is received from a radio station.

“STEREO” also lights up when a stereo signal is received.



- “Wrong Station!” appears when you enter a frequency that is out of reception range.



- You can switch between “Stereo” (stereo) and “Mono” (monaural) for FM radio reception by pressing **MODE**. When the signal reception for an FM radio station is unstable, switching to monaural may improve it.
- You can watch videos input from external devices while listening to radio by selecting the video input jack in “Video Out” (p.67) in the “Option” menu.

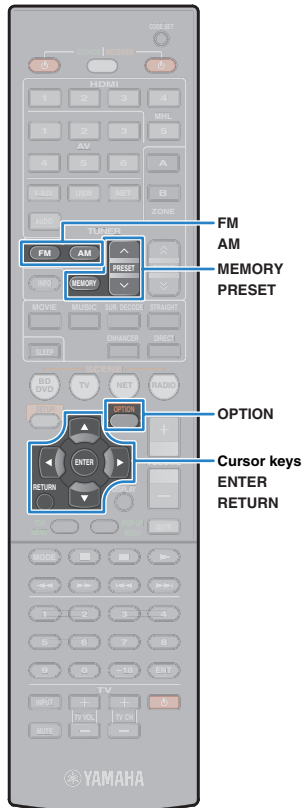

## Registering favorite radio stations (presets)

You can register up to 40 radio stations as presets. Once you have registered stations, you can easily tune into them by selecting their preset numbers.

### ■ Registering radio stations automatically (Auto Preset)

Automatically register FM radio stations with strong signals (up to 40 stations).



- To register AM radio stations, follow "Registering a radio station manually".
- (U.K. and Europe models only)  
Only Radio Data System broadcasting stations are stored automatically by the Auto Preset function.

- 1 Press FM or AM to select "TUNER" as the input source.
- 2 Press OPTION.
- 3 Use the cursor keys to select "Auto Preset".



- 4 To start the Auto Preset process, press ENTER.

The registration will start in 5 seconds. Press ENTER again to start the registration immediately.

"SEARCH" appears during Auto Preset



Preset number from which to start the registration



- To specify the preset number from which to start the registration, press PRESET or cursor keys ( $\Delta/\nabla$ ) to select a preset number within 5 seconds after step 4 (while "READY" is displayed) and then press ENTER (or just wait for 5 seconds).
- To cancel the Auto Preset process, press RETURN.

When the Auto Preset process finishes, "FINISH" appears and the "Option" menu closes automatically.



### ■ Registering a radio station manually

Select a radio station manually and register it to a preset number.

- 1 Follow "Selecting a frequency for reception" (p.43) to tune into the desired radio station.
- 2 Hold down MEMORY for more than 2 seconds.

The first time that you do register a station, the selected radio station will be registered to the preset number "01". Thereafter, each radio station you select will be registered to the next empty (unused) preset number after the most recently registered number.



Preset number



- To select a preset number for registering, press MEMORY once after tuning into the desired radio station, press PRESET to select a preset number, and then press MEMORY again.



"Empty" (not in use) or the frequency currently registered

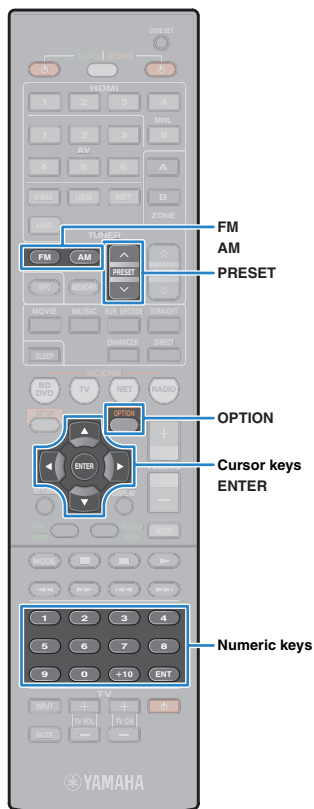

## ■ Selecting a preset station

Tune into a registered radio station by selecting its preset number.

- 1 Press FM or AM to select “TUNER” as the input source.
- 2 Press PRESET repeatedly to select the desired radio station.

You can also enter a preset number (01 to 40) directly by using the numeric keys after pressing PRESET once.



- “No Presets” appears when no radio stations are registered.
- “Wrong Num.” appears when an invalid number is entered.
- “Empty” appears when a preset number not in use is entered.

## ■ Clearing preset stations

Clear radio stations registered to the preset numbers.

- 1 Press FM or AM to select “TUNER” as the input source.
- 2 Press OPTION.
- 3 Use the cursor keys to select “Clear Preset” and press ENTER.



- 4 Use the cursor keys ( $\Delta/\nabla$ ) to select a preset station to be cleared and press ENTER.

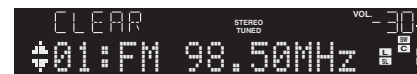

Preset station to be cleared

If the preset station is cleared, “Cleared” appears and then the next in-use preset number is displayed.



- 5 Repeat step 4 until all desired preset stations are cleared.
- 6 To exit from the menu, press OPTION.

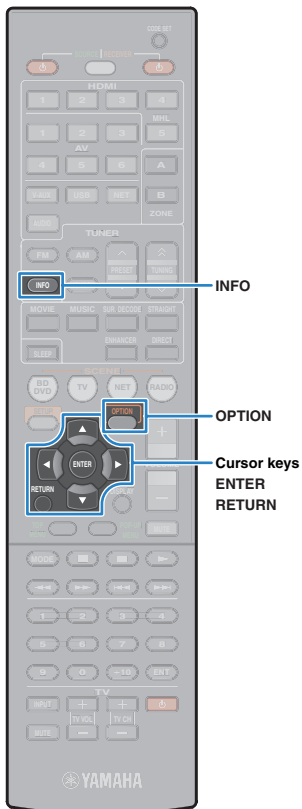

## Radio Data System tuning

(U.K. and Europe models only)

Radio Data System is a data transmission system used by FM stations in many countries. The unit can receive various types of Radio Data System data, such as “Program Service”, “Program Type”, “Radio Text” and “Clock Time”, when it is tuned into a Radio Data System broadcasting station.

### ■ Displaying the Radio Data System information

#### 1 Tune into the desired Radio Data System broadcasting station.



- We recommend using “Auto Preset” to tune into the Radio Data System broadcasting stations (p.44).

#### 2 Press INFO.

Each time you press the key, the displayed item changes.



Item name

About 3 seconds later, the corresponding information for the displayed item appears.



Information

<b>Program Service</b>	Program service name
<b>Program Type</b>	Current program type
<b>Radio Text</b>	Information on the current program
<b>Clock Time</b>	Current time
<b>DSP Program</b>	Sound mode name
<b>Audio Decoder</b>	Decoder name
<b>Frequency</b>	Frequency



- “Program Service”, “Program Type”, “Radio Text”, and “Clock Time” are not displayed if the radio station does not provide the Radio Data System service.

### ■ Receiving traffic information automatically

When “TUNER” is selected as the input source, the unit automatically receives traffic information. To enable this function, follow the procedure below to set the traffic information station.

#### 1 When “TUNER” is selected as the input source, press OPTION.

#### 2 Use the cursor keys to select “Traffic Program” (TrafficProgram) and press ENTER.

The traffic information station search will start in 5 seconds. Press ENTER again to start the search immediately.



- To search upward/downward from the current frequency, press the cursor keys ( $\Delta/\nabla$ ) while “READY” is displayed.
- To cancel the search, press RETURN.
- Texts in parentheses denote indicators on the front display.

The following screen appears for about 3 seconds when the search finishes.



Traffic information station (frequency)



- “TP Not Found” appears for about 3 seconds when no traffic information stations are found.

## Playing back iPod music

You can play back iPod music on the unit using a USB cable supplied with the iPod.



- An iPod may not be detected by the unit or some features may not be compatible, depending on the model or software version of the iPod.
- To play back iPod videos on the unit, an Apple Composite AV Cable (not supplied) is required. Connect the USB and composite video plugs of the Apple Composite AV cable to the USB jack and VIDEO AUX (VIDEO) jack of the unit, and connect your TV and the unit with a video pin cable (p.22). To select a video, operate the iPod itself in the simple play mode (p.49).

### Supported iPod (as of December 2012)

- iPod touch (1st, 2nd, 3rd and 4th generation)
- iPod nano (2nd, 3rd, 4th, 5th and 6th generation)
- iPhone 4S, iPhone 4, iPhone 3GS, iPhone 3G, iPhone
- iPad (3rd generation), iPad 2, iPad

## Connecting an iPod

Connect your iPod to the unit with the USB cable supplied with the iPod.

### 1 Connect the USB cable to the iPod.

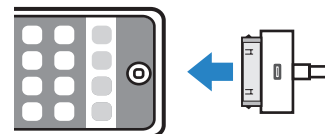

### 2 Connect the USB cable to the USB jack.

The unit (front)

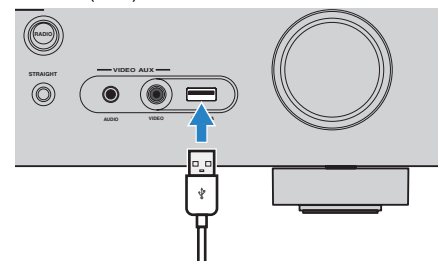

- The iPod charges while it is connected to the unit. If you set the unit to standby mode while the iPod is charging, the iPod continues to charge up to 4 hours. If "Network Standby" (p.81) in the "Setup" menu is set to "On", it continues to charge without limit.



- Disconnect the iPod from the USB jack when it is not in use.

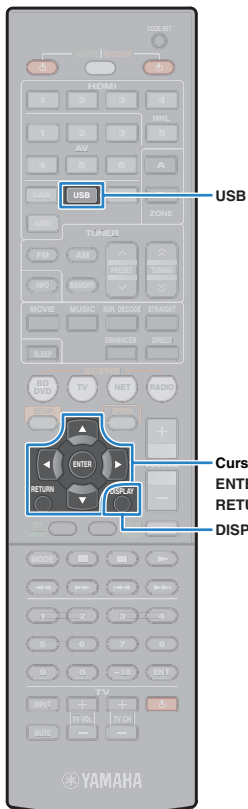

## Playback of iPod content

Follow the procedure below to operate the iPod contents and start playback.

You can control the iPod with the menu displayed on the TV screen.



- Operations with TV screen are available only when your TV is connected to the unit via HDMI. If not, carry out operations while viewing the front display, or directly operate the iPod itself in the simple play mode (p.49).
- “\_” (underscore) will be displayed for characters not supported by the unit.

### 1 Press USB to select “USB” as the input source.

The browse screen is displayed on the TV.



- If playback is ongoing on your iPod, the playback screen is displayed.

### 2 Use the cursor keys to select an item and press ENTER.

If a song is selected, playback starts and the playback screen is displayed.

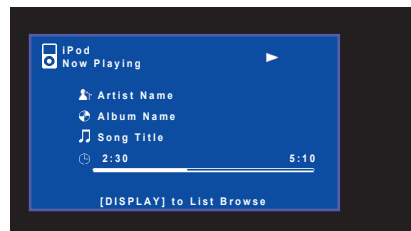

- To return to the previous screen, press RETURN.
- To switch between the browse and playback screens during playback, press DISPLAY.
- To operate the iPod manually to select content or control playback, switch to the simple play mode (p.49).

## Browse screen



#### 1 List name

#### 2 Contents list

Displays the list of iPod content. Use the cursor keys to select an item and press ENTER to confirm the selection.

#### 3 Item number/total

#### 4 Status indicators

Display the current repeat/shuffle settings (p.50) and playback status (such as play/pause).

#### 5 Operation menu

Press the cursor key (▷) and then use the cursor keys (△/▽) to select an item. Press ENTER to confirm the selection.

Icon	Function
	Moves 10 pages backward.
	Moves to the previous page of the list.
	Moves to the next page of the list.
	Moves 10 pages forward.
	Moves to the playback screen.



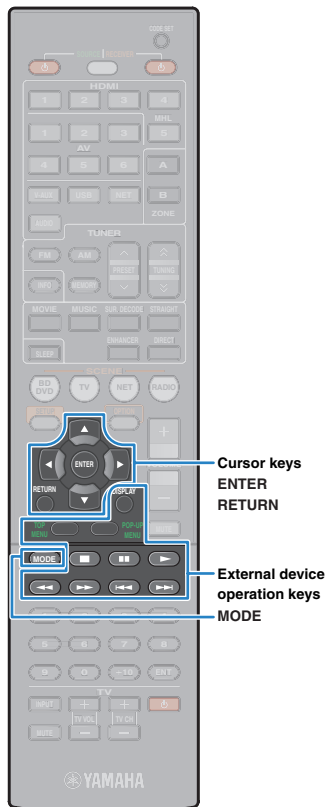

## ■ Playback screen



### 1 Status indicators

Display the current repeat/shuffle settings (p.50) and playback status (such as play/pause).

### 2 Playback information

Displays the artist name, album name, song title, and elapsed time/song length.

Use the following remote control keys to control playback.

External device operation keys	Function
	Resumes playback from pause.
	Stops playback.
	Stops playback temporarily.
	Skips forward/backward.
	Searches forward/backward (by holding down).

## ■ Operating the iPod itself or remote control (simple play)

### 1 Press MODE to switch to the simple play mode.

The TV menu screen turns off and iPod operations are enabled.

To display the TV menu screen, press MODE again.

### 2 Operate your iPod itself or the remote control to start playback.

Operational remote control keys	Function
<b>Cursor keys</b>	Select an item.
<b>ENTER</b>	Confirms the selection.
<b>RETURN</b>	Returns to the previous screen.
	Starts playback or stops playback temporarily.
	Stops playback.
<b>External device operation keys</b>	
	Skips forward/backward.
	Searches forward/backward (while holding down).

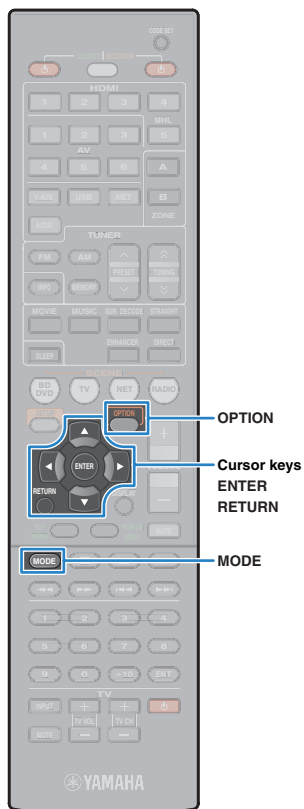

## Repeat/shuffle settings

You can configure the repeat/shuffle settings of your iPod.



- During simple play, configure the repeat/shuffle settings directly on your iPod or press MODE to display the TV menu screen and then follow the procedure below.

**1** When “USB” is selected as the input source, press **OPTION**.

**2** Use the cursor keys to select “Shuffle” (Shuffle) or “Repeat” (Repeat) and press **ENTER**.



- To return to the previous screen during menu operations, press RETURN.
- Texts in parentheses denote indicators on the front display.

**3** Use the cursor keys (</>) to select a setting.

Item	Setting	Function
<b>Shuffle (Shuffle)</b>	Off (Off)	Turns off the shuffle function.
	Songs (Songs)	Plays back songs in random order. “⌘” appears in the TV screen.
	Albums (Albums)	Plays back albums in random order. “⌘” appears in the TV screen.
<b>Repeat (Repeat)</b>	Off (Off)	Turns off the repeat function.
	One (One)	Plays back the current song repeatedly. “↺” appears in the TV screen.
	All (All)	Plays back all songs repeatedly. “↻” appears in the TV screen.

**4** To exit from the menu, press **OPTION**.



## Playing back music stored on a USB storage device

You can play back music files stored on a USB storage device on the unit. Refer to the instruction manuals for the USB storage device for more information.

The unit supports USB mass storage class devices (FAT16 or FAT32 format).



- The unit supports WAV (PCM format only), MP3, WMA, MPEG-4 AAC and FLAC files (1- or 2-channel audio only).
- The unit is compatible with sampling rate of up to 192 kHz for WAV and FLAC files, and 48 kHz for other files.
- Some features may not be compatible, depending on the model or manufacturer of the USB storage device.
- Digital Rights Management (DRM) contents cannot be played back.

### Connecting a USB storage device

#### 1 Connect the USB storage device to the USB jack.

The unit (front)

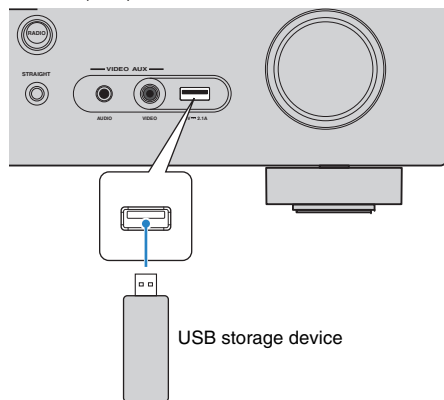

- If the USB storage device contains many files, it may take time to load the them. In this case, "Loading..." appears in the front display.



- Disconnect the USB storage device from the USB jack when it is not in use.
- Stop playback of the USB storage device before disconnect it from the USB jack.
- You cannot connect the PC to the USB jack of the unit.

### Playback of USB storage device contents

Follow the procedure below to operate the USB storage device contents and start playback.

You can control the USB memory device with the menu displayed on the TV screen.



- Operations with TV screen are available only when your TV is connected to the unit via HDMI. If not, carry out operations while viewing the front display.
- “\_” (underscore) will be displayed for characters not supported by the unit.

#### 1 Press USB to select “USB” as the input source.

The browse screen is displayed on the TV.

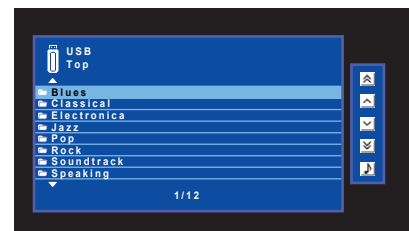

- If playback is ongoing on your USB storage device, the playback screen is displayed.



Cursor keys  
ENTER  
RETURN  
DISPLAY

## 2 Use the cursor keys to select an item and press ENTER.

If a song is selected, playback starts and the playback screen is displayed.

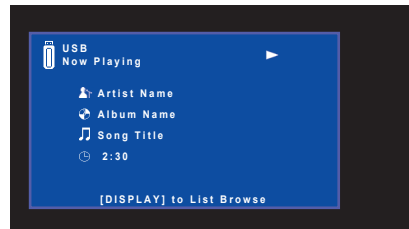

- To return to the previous screen, press RETURN.
- To switch between the browse and playback screens during playback, press DISPLAY.
- Files not supported by the unit cannot be selected.

## ■ Browse screen



### 1 List name

### 2 Contents list

Displays the list of USB storage device contents. Use the cursor keys to select an item and press ENTER to confirm the selection.

### 3 Item number/total

### 4 Status indicators

Display the current repeat/shuffle settings (p.53) and playback status (such as play/pause).

### 5 Operation menu

Press the cursor key (▷) and then use the cursor keys (△/▽) to select an item. Press ENTER to confirm the selection.

Icon	Function
	Moves 10 pages backward.
	Moves to the previous page of the list.
	Moves to the next page of the list.
	Moves 10 pages forward.
	Moves to the playback screen.

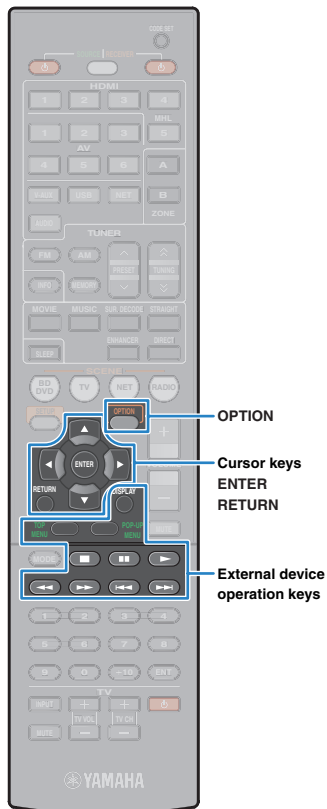

## ■ Playback screen



### 1 Status indicators

Display the current repeat/shuffle settings (p.53) and playback status (such as play/pause).

### 2 Playback information

Displays the artist name, album name, song title, and elapsed time.

Use the following remote control keys to control playback.

External device operation keys	Function
	Resumes playback from pause.
	Stops playback.
	Stops playback temporarily.
	Skips forward/backward.

## ■ Repeat/shuffle settings

You can configure the repeat/shuffle settings for playback of USB storage device contents.

**1** When “USB” is selected as the input source, press **OPTION**.

**2** Use the cursor keys to select “Shuffle” (Shuffle) or “Repeat” (Repeat) and press **ENTER**.



- To return to the previous screen during menu operations, press RETURN.
- Texts in parentheses denote indicators on the front display.

**3** Use the cursor keys (</>) to select a setting.

Item	Setting	Function
<b>Shuffle (Shuffle)</b>	Off (Off)	Turns off the shuffle function.
	On (On)	Plays back songs in the current album (folder) in random order. “” appears on the TV screen.
<b>Repeat (Repeat)</b>	Off (Off)	Turns off the repeat function.
	One (One)	Plays back the current song repeatedly. “” appears on the TV screen.
	All (All)	Plays back all songs in the current album (folder) repeatedly. “” appears on the TV screen.

**4** To exit from the menu, press **OPTION**.

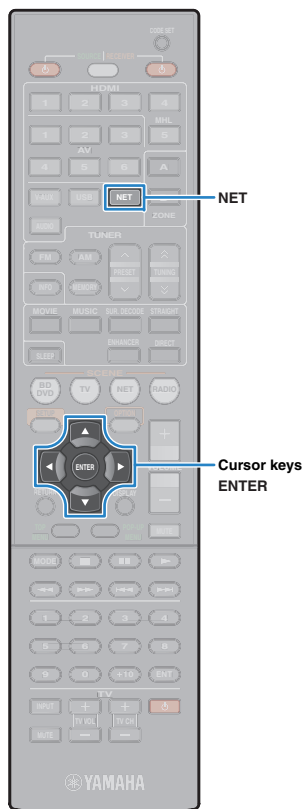

## Playing back music stored on media servers (PCs/NAS)

You can play back music files stored on your PC or DLNA-compatible NAS on the unit.



- To use this function, the unit and your PC must be connected to the same router (p.28). You can check whether the network parameters (such as the IP address) are properly assigned to the unit in "Information" (p.80) in the "Setup" menu.
- The unit supports playback of WAV (PCM format only), MP3, WMA, MPEG-4 AAC and FLAC files.
- The unit is compatible with sampling rates of up to 192 kHz for WAV and FLAC files, and 48 kHz for other files.
- To play back FLAC files, you need to install server software that supports sharing of FLAC files via DLNA on your PC or use a NAS that supports FLAC files.

### Media sharing setup

To play back music files stored on your PC or DLNA-compatible NAS, first you need to configure the media sharing setting on each music server.

#### ■ For a PC with Windows Media Player installed

- 1 Check that Windows Media Player 11 or later is installed on your PC.
- 2 In the media sharing settings, enable media sharing and allow media to be shared with the device.

#### ■ For a PC or a NAS with other DLNA server software installed

Refer to the instruction manual for the device or software and configure the media sharing settings.

### Playback of PC music contents

Follow the procedure below to operate the PC music contents and start playback.

You can control the PC/NAS with the menu displayed on the TV screen.



- Operations with TV screen are available only when your TV is connected to the unit via HDMI. If not, carry out operations while viewing the front display.
- “\_” (underscore) will be displayed for characters not supported by the unit.

- 1 Press NET repeatedly to select “SERVER” as the input source.

The browse screen is displayed on the TV.

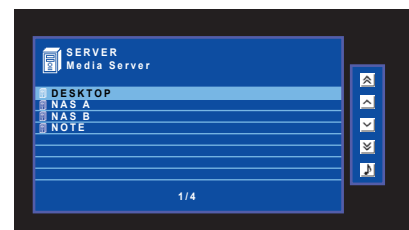

- If playback of a music file selected from the unit is ongoing on your PC, the playback screen is displayed.

- 2 Use the cursor keys to select a music server and press ENTER.



### 3 Use the cursor keys to select an item and press ENTER.

If a song is selected, playback starts and the playback screen is displayed.

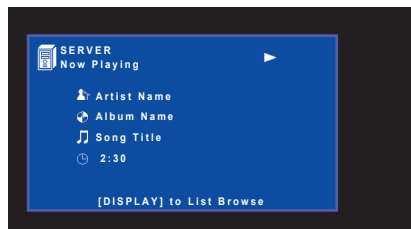

- To return to the previous screen, press RETURN.
- To switch between the browse and playback screens during playback, press DISPLAY.
- Files not supported by the unit cannot be selected.

## ■ Browse screen



### 1 List name

### 2 Contents list

Displays the list of PC content. Use the cursor keys to select an item and press ENTER to confirm the selection.

### 3 Item number/total

### 4 Status indicators

Display the current repeat/shuffle settings (p.56) and playback status (such as play/pause).

### 5 Operation menu

Press the cursor key (▷) and then use the cursor keys (△/▽) to select an item. Press ENTER to confirm the selection.

Icon	Function
	Moves 10 pages backward.
	Moves to the previous page of the list.
	Moves to the next page of the list.
	Moves 10 pages forward.
	Moves to the playback screen.

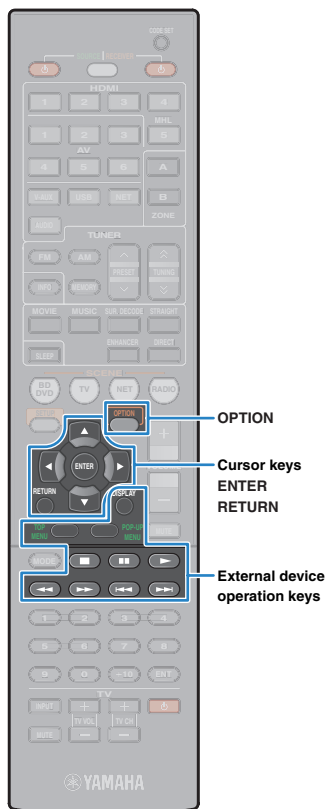

## ■ Playback screen



### 1 Status indicators

Display the current repeat/shuffle settings (p.56) and playback status (such as play/pause).

### 2 Playback information

Displays the artist name, album name, song title, and elapsed time.

Use the following remote control keys to control playback.

External device operation keys	Function
	Resumes playback from pause.
	Stops playback.
	Stops playback temporarily.
	Skips forward/backward.



- You can also use a DLNA-compatible Digital Media Controller (DMC) to control playback. For details, see "DMC Control" (p.81).

## ■ Repeat/shuffle settings

You can configure the repeat/shuffle settings for the playback of PC music content.

- 1 When "SERVER" is selected as the input source, press **OPTION**.
- 2 Use the cursor keys to select "Shuffle" (Shuffle) or "Repeat" (Repeat) and press **ENTER**.



- To return to the previous screen during menu operations, press **RETURN**.
- Text in parentheses denotes indicators on the front display.

### 3 Use the cursor keys (</>) to select a setting.

Item	Setting	Function
<b>Shuffle (Shuffle)</b>	Off (Off)	Turns off the shuffle function.
	On (On)	Plays back songs in the current album (folder) in random order. "⌘" appears on the TV screen.
<b>Repeat (Repeat)</b>	Off (Off)	Turns off the repeat function.
	One (One)	Plays back the current song repeatedly. "↺" appears on the TV screen.
	All (All)	Plays back all songs in the current album (folder) repeatedly. "↻" appears on the TV screen.

### 4 To exit from the menu, press **OPTION**.



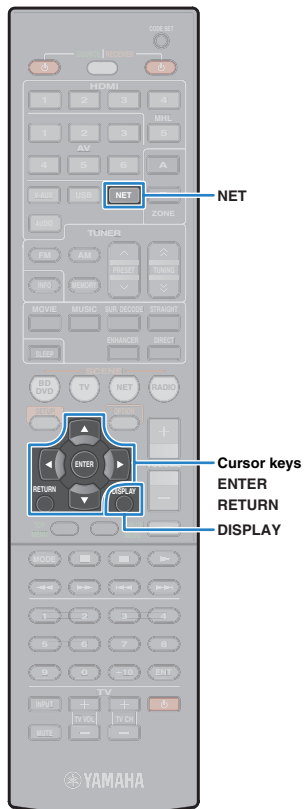

## Listening to Internet radio

You can listen to Internet radio stations from all over the world. You can control the Internet radio with the menu displayed on the TV screen.



- Operations with TV screen are available only when your TV is connected to the unit via HDMI. If not, carry out operations while viewing the front display.
- To use this function, the unit must be connected to the Internet (p.28). You can check whether the network parameters (such as the IP address) are properly assigned to the unit in "Information" (p.80) in the "Setup" menu.
- This service may be discontinued without notice.
- You may not be able to receive some Internet radio stations.
- The unit uses the vTuner Internet radio station database service.

### 1 Press NET repeatedly to select "NET RADIO" as the input source.

The browse screen is displayed on the TV.

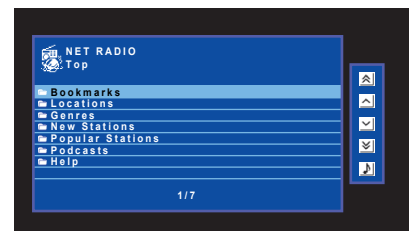

### 2 Use the cursor keys to select an item and press ENTER.

If an Internet radio station is selected, playback starts and the playback screen is displayed.



- To return to the previous screen, press RETURN.
- To switch between the browse and playback screens during playback, press DISPLAY.
- You can register your favorite Internet radio stations to the "Bookmarks" folder by selecting "NET RADIO" as the input source on the unit and then accessing the following website with the web browser on your PC. To use this feature, you need the vTuner ID of the unit and your e-mail address to create your personal account. You can check the vTunerID (MAC address of the unit) in "Information" (p.80) in the "Setup" menu.  
<http://yradio.vtuner.com/>

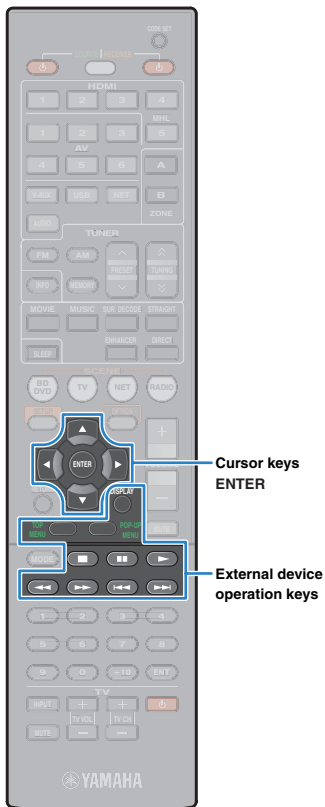

## ■ Browse screen



- 1 **List name**
- 2 **Contents list**  
Displays the list of Internet radio content. Use the cursor keys to select an item and press ENTER to confirm the selection.
- 3 **Item number/total**
- 4 **Playback indicator**
- 5 **Operation menu**  
Press the cursor key (▷) and then use the cursor keys (△/▽) to select an item. Press ENTER to confirm the selection.

Icon	Function
	Moves 10 pages backward.
	Moves to the previous page of the list.
	Moves to the next page of the list.
	Moves 10 pages forward.
	Moves to the playback screen.

## ■ Playback screen



- 1 **Playback indicator**
  - 2 **Playback information**  
Displays the station name, album name, song title, and elapsed time.
- 
- Use the external device operation key (■) to stop playback.
  - Some information may not be available depending on the station.

## Playing back iTunes/iPod music via a network (AirPlay)

The AirPlay function allows you to play back iTunes/iPod music on the unit via network.

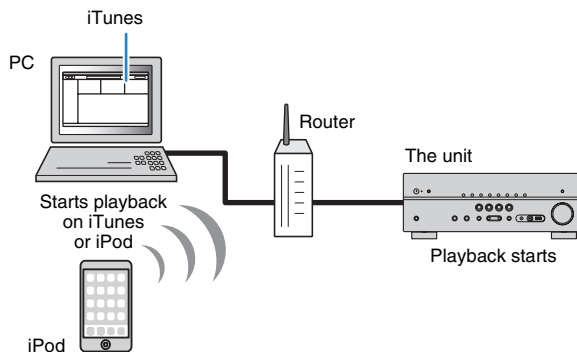

- To use this function, the unit and your PC or iPod must be connected to the same router (p.28). You can check whether the network parameters (such as the IP address) are properly assigned to the unit in "Information" (p.80) in the "Setup" menu.

### Supported iTunes/iPod (as of December 2012)

- iTunes 10.2.2 or later (Windows/Mac)
- iPod touch, iPhone or iPad with iOS 4.3.3 or later

## Playback of iTunes/iPod music contents

Follow the procedure below to play back iTunes/iPod music contents on the unit.

### 1 Turn on the unit, and start iTunes on the PC or display the playback screen on the iPod.

If the iTunes/iPod recognizes the unit, the AirPlay icon (  ) appears.

iTunes (example)



iPod (example)

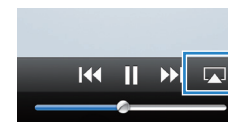

- If the icon does not appear, check whether the unit and PC/iPod are connected to the router properly.

### 2 On the iTunes/iPod, click (tap) the AirPlay icon and select the unit (network name of the unit) as the audio output device.

iTunes (example)

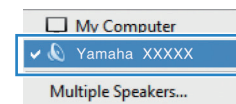

iPod (example)

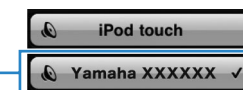

Network name of the unit

### 3 Select a song and start playback.

The unit automatically selects "AirPlay" as the input source and starts playback.

The playback screen is displayed on the TV.



- The playback screen is available only when your TV is connected to the unit via HDMI.



External device operation keys



- You can turn on the unit automatically when starting playback on iTunes or iPod by setting "Network Standby" (p.81) in the "Setup" menu to "On".
- You can edit the network name (the unit's name on the network) displayed on iTunes/iPod in "Network Name" (p.81) in the "Setup" menu.
- If you select the other input source on the unit during playback, playback on the iTunes/iPod stops automatically.
- You can adjust the unit's volume from the iTunes/iPod during playback. To disable volume controls from iTunes/iPod, set "Volume Interlock" (p.67) in the "Option" menu to "Off".

#### Caution

- When you use iTunes/iPod controls to adjust volume, the volume may be unexpectedly loud. This could result in damage to the unit or speakers. If the volume suddenly increases during playback, stop playback on the iTunes/iPod immediately.

## ■ Playback screen

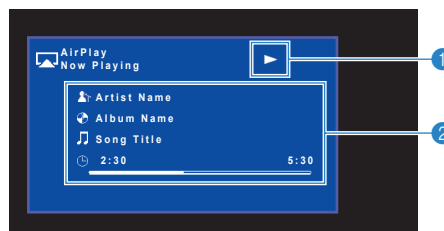

### 1 Playback indicator

### 2 Playback information

Displays the artist name, album name, song title, and elapsed time/song length.

Use the following remote control keys to control playback.

External device operation keys	Function
	Resumes playback from pause.
	Stops playback.
	Stops playback temporarily.
	Skips forward/backward.



- To control iTunes playback with the remote control of the unit, you need to configure the iTunes preferences to enable iTunes control from remote speakers in advance.

iTunes (example of English version)

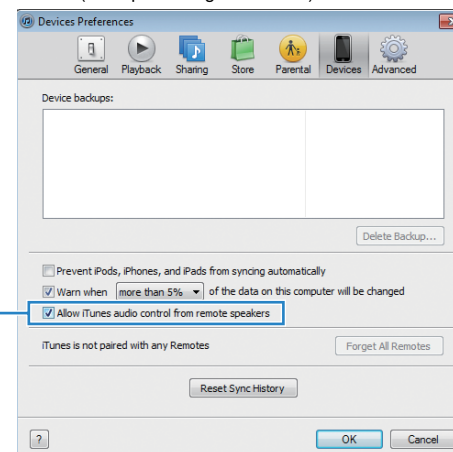

Check this box

## Playing back music in multiple rooms (RX-V575 only)

The Zone A/B function allows you to play back an input source in the room where the unit is installed (Zone A) and in another room (Zone B).

For example, you can turn on Zone A (turn off Zone B) when you are in the living room, and turn on Zone B (turn off Zone A) when you are in the study room. Also, you can turn on both zones when you want to enjoy the same input source in those rooms simultaneously.

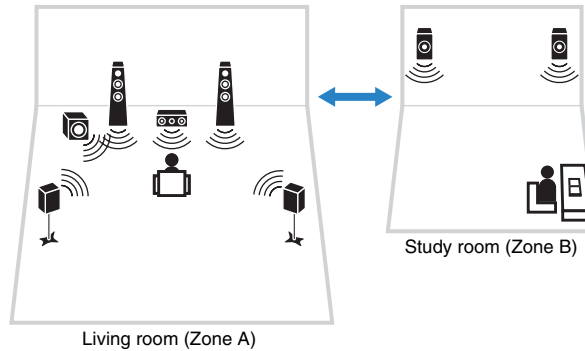

- Multichannel sources are mixed down to 2 channels and output to the zone B.
- The same input source is applied to both Zone A and Zone B.
- By default, the volume for Zone B changes in conjunction with the volume for Zone A. If there is volume difference between Zone A/B, you can correct it in "ZoneB Trim" in the "Option" menu (p.62). Also, you can adjust the volume for Zone B separately (p.62).
- You can automatically enable/disable the audio output to Zone A/B in conjunction with a scene selection (p.36)

## Preparing Zone B

Connect the device that will be used in Zone B to the unit.

### Caution

- Remove the unit's power cable from the AC wall outlet before connecting speakers.
- Ensure that the core wires of the speaker cable do not touch one another or come into contact with the unit's metal parts. Doing so may damage the unit or the speakers. If the speaker cables short circuit, "Check SP Wires" will appear on the front display when the unit is turned on.

Connect the speakers placed in Zone B to the unit with speaker cables.

To utilize the SURROUND BACK/BI AMP/ZONE B jacks for Zone B speakers, set "Power Amp Assign" (p.71) in the "Setup" menu to "Zone B" after connecting the power cable to an AC wall outlet.

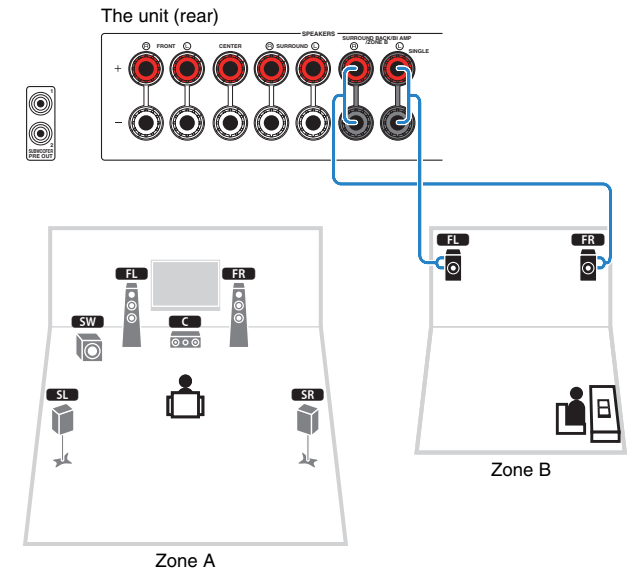

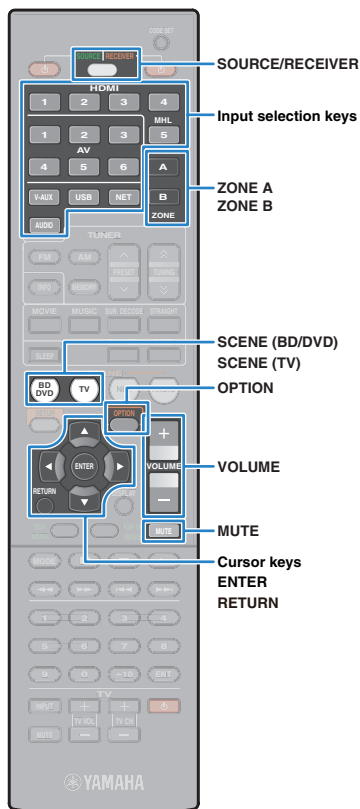

## ■ Basic playback procedure

- 1 Press **ZONE A** or **ZONE B** to enable/disable audio output to Zone A or Zone B.

“SP A” lights up in the front display when the Zone A output is enabled and “SP B” lights up when the Zone B output is enabled.



- 2 Use the input selection keys to select an input source.
- 3 Start playback on the external device or select a radio station.
- 4 Press **VOLUME** to adjust the volume.

## ■ Correcting volume difference between Zone A and Zone B

If you are bothered by volume difference between Zone A/B, follow the procedure below to adjust the volume for Zone B.

- 1 Press **OPTION**.
- 2 Use the cursor keys to select “Volume Trim” (Volume Trim) and press **ENTER**.



- To return to the previous screen during menu operations, press **RETURN**.
- Text in parentheses denotes indicators on the front display.

- 3 Use the cursor keys ( $\Delta/\nabla$ ) to select “ZoneB Trim” (ZB.Trim) and the cursor keys ( $\leftarrow/\rightarrow$ ) to adjust the setting.

### Setting range

-10.0 dB to +10.0 dB (0.5 dB increments)

### Default

0.0 dB

- 4 To exit from the menu, press **OPTION**.



- This setting is not effective when “ZoneB Volume” (p.77) in the “Setup” menu is set to “Async.”.

## ■ Adjusting the volume for Zone B separately

You can separately adjust the volume for Zone B using the remote control when “ZoneB Volume” (p.77) in the “Setup” menu is set to “Async.”.

- 1 To set the remote control to the Zone B operation mode, while holding down the cursor key ( $\triangleright$ ), hold down **SCENE (TV)** for more than 3 seconds.

SOURCE/RECEIVER blinks twice.

- 2 Press **VOLUME** to adjust the volume for Zone B.



- To mute the audio output to Zone B, press **MUTE**.

- 3 To set the remote control to the Zone A operation mode, while holding down the cursor key ( $\triangleright$ ), hold down **SCENE (BD/DVD)** for more than 3 seconds.

SOURCE/RECEIVER blinks twice.

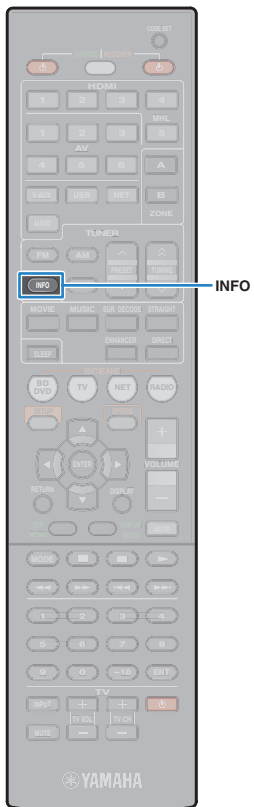

## Viewing the current status

### Switching information on the front display

#### 1 Press INFO.

Each time you press the key, the displayed item changes.



Item name

About 3 seconds later, the corresponding information for the displayed item appears.



Information



- Available items vary depending on the selected input source. The displayed item can also be applied separately to each input source group.

Input source group	Item
<b>HDMI 1–5</b>	
<b>AV 1–6</b>	Input (input source name), DSP Program (sound mode name), Audio Decoder (decoder name*)
<b>AUDIO</b>	
<b>V-AUX</b>	
<b>USB SERVER</b>	Song (song title), Artist (artist name), Album (album name), DSP Program (sound mode name), Audio Decoder (decoder name*)
<b>AirPlay</b>	
	* During simple playback of iPod: Input (input source name), DSP Program (sound mode name), Audio Decoder (decoder name)
<b>NET RADIO</b>	Song (song title), Album (album name), Station (station name), DSP Program (sound mode name), Audio Decoder (decoder name*)
<b>TUNER</b>	Frequency (frequency), DSP Program (sound mode name), Audio Decoder (decoder name*)
	* (U.K. and Europe models only) Radio Data System data is also available when the unit is tuned into a Radio Data System broadcasting station (p.46).

\* The name of the audio decoder currently activated is displayed. If no audio decoder is activated, "Decoder Off" appears.

## Configuring playback settings for different playback sources (Option menu)

You can configure separate playback settings for different playback sources. This menu is available on the front panel (or on the TV screen), allowing you to easily configure settings during playback.

### 1 Press **OPTION**.



Front display

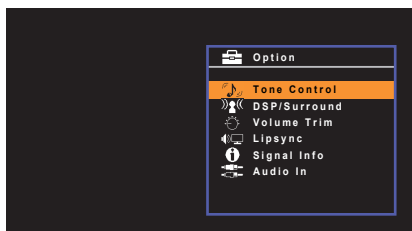

TV screen

### 2 Use the cursor keys to select an item and press **ENTER**.



- To return to the previous screen during menu operations, press RETURN.

### 3 Use the cursor keys (</>) to select a setting.

### 4 To exit from the menu, press **OPTION**.

## Option menu items



- Available items vary depending on the selected input source.
- Text in parentheses denotes indicators on the front display.
- Depending on the region of purchase, some menu items for audio streaming services are also available. For details, refer to each manual on the supplied CD-ROM.

Item	Function	Page	
<b>Tone Control (Tone Control)</b>	Adjusts the high-frequency range and low-frequency range of sounds.	65	
<b>DSP/Surround (DSP/Surround)</b>	<b>DSP Level (DSP Level)</b>	Adjusts the sound field effect level.	65
	<b>Adaptive DRC (A.DRC)</b>	Sets whether the dynamic range (from maximum to minimum) is automatically adjusted when the volume is adjusted.	65
	<b>Extended Surround (EXTD)</b>	(RX-V575 only) Selects how to play back 5.1- to 7.1-channel sources when surround back speakers are used.	65
	<b>Enhancer (Enhancer)</b>	Enables/disables Compressed Music Enhancer.	66
	<b>Input Trim (In.Trim)</b>	Corrects volume differences between input sources.	66
<b>Volume Trim (Volume Trim)</b>	<b>Subwoofer Trim (SW.Trim)</b>	Fine-adjusts the subwoofer volume.	66
	<b>ZoneB Trim (ZB.Trim)</b>	(RX-V575 only) Corrects volume differences between Zone A/B.	62
<b>Lipsync (Lipsync)</b>	Enables/disables the "Lipsync" setting in the "Setup" menu.	66	
<b>Signal Info (Signal Info)</b>	Displays information about the video/audio signal.	66	
<b>Audio In (Audio In)</b>	Combines the video jack of the selected input source with an audio jack of others.	67	
<b>Video Out (Video Out)</b>	Selects a video to be output with radio sounds.	67	
<b>Auto Preset (Auto Preset)</b>	Automatically registers FM radio stations with strong signals as presets.	44	
<b>Clear Preset (Clear Preset)</b>	Clear radio stations registered to preset numbers.	45	



Item	Function	Page
<b>Traffic Program (TrafficProgram)</b>	(U.K. and Europe models only) Automatically searches for a traffic information station.	46
<b>Repeat (Repeat)</b>	Configures the repeat setting for the iPod (p.50), USB storage device (p.53), or media server (p.56).	—
<b>Shuffle (Shuffle)</b>	Configures the shuffle setting for the iPod (p.50), USB storage device (p.53), or media server (p.56).	—
<b>Volume Interlock (Interlock)</b>	Enables/disables volume controls from iTunes/iPod via AirPlay.	67

## ■ Tone Control (Tone Control)

Adjusts the high-frequency range (Treble) and low-frequency range (Bass) of sounds.

### Choices

Treble (Treble), Bass (Bass)

### Setting range

-6.0 dB to Bypass (Bypass) to +6.0 dB, \*0.5 dB increments

### Default

Bypass (Bypass)



- If you set an extreme value, sounds may not match those from other channels.

### Adjusting with the front panel controls

- ① Press TONE CONTROL to select “Treble” or “Bass”.
- ② Press PROGRAM to make an adjustment.

## ■ DSP/Surround (DSP/Surround)

Configures the sound field program and surround settings.

### □ DSP Level (DSP Level)

Adjusts the sound field effect level.

#### Setting range

-6 dB to +3 dB (1 dB increments)

#### Default

0 dB

### □ Adaptive DRC (A.DRC)

Sets whether the dynamic range (from maximum to minimum) is automatically adjusted when the volume level is adjusted. When it is set to “On”, it is useful for listening to playback at a low volume at night.

#### Settings

On (On)	Automatically adjusts the dynamic range.
Off (Off) (default)	The dynamic range is not automatically adjusted.

If “On” is selected, the dynamic range becomes narrow at a low volume and wide at a high volume.

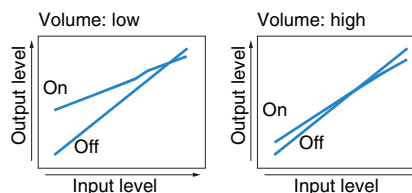

### □ Extended Surround (EXTD)

(RX-V575 only)

Selects how to play back 5.1- to 7.1-channel sources when surround back speakers are used.

#### Settings

Auto (Auto) (default)	Automatically selects the most suitable decoder if signals that contain surround back channel signals are input, and reproduces the signals in 6.1- or 7.1-channel. If two surround back speakers are connected, the unit reproduces the 5.1-channel signals in 7.1-channel.
<input checked="" type="checkbox"/> PLIIx Movie ( <input checked="" type="checkbox"/> PLIIxMo)	Always reproduces signals in 7.1-channel using the Dolby Pro Logic IIx Movie decoder. This setting is available only when two surround back speakers are connected.
<input checked="" type="checkbox"/> PLIIx Music ( <input checked="" type="checkbox"/> PLIIxMu)	Always reproduces signals in 6.1- or 7.1-channel using the Dolby Pro Logic IIx Music decoder. This setting is available only when one or two surround back speakers are connected.
EX/ES (EX/ES)	Automatically selects the Dolby EX or DTS-ES decoder, and reproduces signals in 6.1- or 7.1-channel.
Off (Off)	Always reproduces signals in their original channels. (Even when DTS-ES or Dolby Digital Surround EX signal is input, the unit reproduces the signal in 5.1-channel.)



- Some early Dolby Digital EX or DTS-ES sources do not contain a flag for reproducing surround back channel. We recommend you set "Extended Surround" to "Dolby PLIIx Movie" or "EX/ES" when playing back those sources.

## Enhancer (Enhancer)

Enables/disables Compressed Music Enhancer (p.42).



- This setting is applied separately to each input source.
- You can also use ENHANCER on the remote control to enable/disable Compressed Music Enhancer (p.42).

### Settings

Off (Off)	Disables Compressed Music Enhancer.
On (On)	Enables Compressed Music Enhancer.

### Default

USB, SERVER, NET RADIO, AirPlay, TUNER: On (On)  
Others: Off (Off)

## Volume Trim (Volume Trim)

Fine-adjusts volume difference between input sources or subwoofer volume.

## Input Trim (In.Trim)

Corrects volume differences between input sources. If you are bothered by volume differences when switching between input sources, use this function to correct it.



- This setting is applied separately to each input source.

### Setting range

-6.0 dB to +6.0 dB (0.5 dB increments)

### Default

0.0 dB

## Subwoofer Trim (SW.Trim)

Fine-adjusts the subwoofer volume.

### Setting range

-6.0 dB to +6.0 dB (0.5 dB increments)

### Default

0.0 dB

## Lipsync (Lipsync)

Enables/disables the adjustment configured in "Lipsync" (p.76) in the "Setup" menu.



- This setting is applied separately to each input source.

### Settings

Off (Off)	Disables the "Lipsync" adjustment.
On (On)	Enables the "Lipsync" adjustment.

### Default

AirPlay: Off (Off)  
Others: On (On)

## Signal Info (Signal Info)

Displays information about the video/audio signal.

### Choices

Format (FORMAT)	Audio format of the input signal
Channel (CHAN)	The number of source channels in the input signal (front/surround/LFE) For example, "3/2/0.1" means 3 front channels, 2 surround channels, and LFE.
Sampling (SAMPL)	The number of samples per second of the input digital signal
Bitrate (B RATE)	The amount of data per second of the input bitstream signal
Input (V IN)	Type and resolution of input signal
Output (V OUT)	Type and resolution of output signal



- To switch the information on the front display, press the cursor keys ( $\Delta/\nabla$ ) repeatedly.

## ■ Audio In (Audio In)

Combines the video jack of the selected input source (HDMI 1–5 or AV 1–2) with an audio jack of others. For example, use this function in the following cases.

- Connecting a playback device that supports HDMI video output, but not HDMI audio output
- Connecting a playback device that has component video jacks and analog stereo jacks (such as game consoles)

### Input sources

HDMI 1–5, AV 1–2

## ■ Setup procedure

### (To input audio through a digital optical jack)

Select “AV 1” or “AV 4” and connect the device to the unit’s corresponding audio jacks with a digital optical cable.

### (To input audio through a digital coaxial jack)

Select “AV 2” or “AV 3” and connect the device to the unit’s corresponding audio jacks with a digital coaxial cable.

### (To input audio through analog audio jacks)

Select “AV 5”, “AV 6”, or “AUDIO”, and connect the device to the unit’s corresponding audio jacks with a stereo pin cable.

## ■ Video Out (Video Out)

Selects a video to be output with radio sounds.

### Settings

Off (Off) (default)	Does not output video.
HDMI 1–5, AV 1–6, V-AUX	Outputs video input through the corresponding video input jacks.

## ■ Volume Interlock (Interlock)

Enables/disables volume controls from iTunes/iPod via AirPlay.

### Settings

Off (Off)	Disables volume controls from iTunes/iPod.
Limited (Ltd) (default)	Enables volume controls from iTunes/iPod within the limited range (-80 dB to 0 dB and mute).
Full (Full)	Enables volume controls from iTunes/iPod in the full range (-80 dB to +16.5 dB and mute).

# CONFIGURATIONS

## Configuring various functions (Setup menu)

You can configure the unit's various function with the menu displayed on the TV screen.



- Operations with TV screen are available only when your TV is connected to the unit via HDMI. If not, carry out operations while viewing the front display.

- 1 Press SETUP.**
- 2 Use the cursor keys to select a menu and press ENTER.**

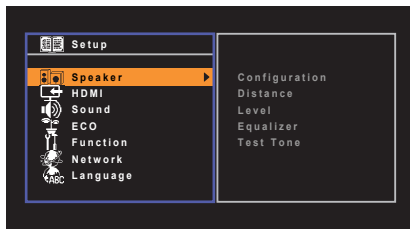

- 3 Use the cursor keys to select an item and press ENTER.**

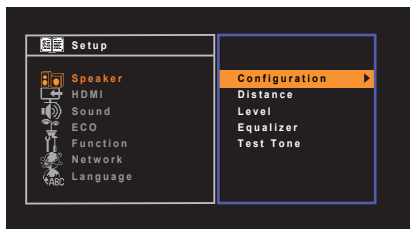

- To return to the previous screen during menu operations, press RETURN.

- 4 Use the cursor keys (</>) to select a setting and press ENTER.**
- 5 To exit from the menu, press SETUP.**

## Setup menu items

Menu	Item	Function	Page	
Speaker	Configuration	<b>Power Amp Assign</b>	(RX-V575 only) Selects a speaker system.	71
		<b>Subwoofer</b>	Selects whether or not a subwoofer is connected.	71
		<b>Front</b>	Selects the size of the front speakers.	71
		<b>Center</b>	Selects whether or not a center speaker is connected and its size.	71
		<b>Surround</b>	Selects whether or not surround speakers are connected and their size.	72
		<b>Surround Back</b>	(RX-V575 only) Selects whether or not surround back speakers are connected and their size.	72
		<b>Crossover</b>	Sets the lower limit of the low-frequency component that can be output from speakers whose size is set to "Small".	72
		<b>Subwoofer Phase</b>	Sets the phase of the subwoofer.	72
		<b>Extra Bass</b>	Sets the speakers to produce the front channel low-frequency components.	72
	<b>Distance</b>	Sets the distance between each speaker and listening position.	73	
	<b>Level</b>	Adjusts the volume of each speaker.	73	
	<b>Equalizer</b>	Adjusts the tone with an equalizer.	73	
	<b>Test Tone</b>	Enables/disables the test tone output.	73	
HDMI	Configuration	<b>HDMI Control</b>	Enables/disables HDMI Control.	74
		<b>Audio Output</b>	Selects a device to output audio.	74
		<b>Standby Through</b>	Selects whether to output videos/audio (input through HDMI jacks) to the TV when the unit is in standby mode.	74
		<b>TV Audio Input</b>	Selects an audio input jack of the unit to be used for TV audio input.	74
		<b>Standby Sync</b>	Selects whether to use HDMI control to link the standby behavior of the TV and the unit.	75
		<b>ARC</b>	Enables/disables ARC.	75
		<b>SCENE</b>	Enables/disables SCENE link playback.	75

Menu	Item	Function	Page	
Sound	DSP Parameter	<b>CINEMA DSP 3D Mode</b>	Enables/disables CINEMA DSP 3D.	75
		<b>Panorama</b>	Enables/disables the broadening effect of the front sound field.	75
		<b>Center Width</b>	Adjusts the broadening effect of the center sound field.	76
		<b>Dimension</b>	Adjusts the difference in level between the front and surround sound fields.	76
		<b>Center Image</b>	Adjusts the center orientation level (broadening effect) of the front sound field.	76
	Lipsync	<b>Select</b>	Selects the method to adjust the delay between video and audio output.	76
		<b>Adjustment</b>	Adjusts the delay between video and audio output manually.	76
	Volume	<b>Dynamic Range</b>	Selects the dynamic range adjustment method for bitstream audio (Dolby Digital and DTS signals) playback.	77
		<b>Max Volume</b>	Sets the maximum volume to prevent excessive loudness.	77
		<b>Initial Volume</b>	Sets the initial volume for when this receiver is turned on.	77
		<b>ZoneB Volume</b>	(RX-V575 only) Selects whether to adjust the volume for Zone B in conjunction with the volume for Zone A.	77
ECO	<b>Auto Power Standby</b>	Sets the amount of time for the auto-standby function.	77	
	<b>ECO Mode</b>	Enables/disables the eco mode (power saving mode).	78	
Function	<b>Input Rename</b>	Changes the input source name displayed on the front display.	78	
	<b>Dimmer</b>	Adjusts the brightness of the front display.	79	
	<b>Memory Guard</b>	Prevents accidental changes to the settings.	79	
	<b>DC OUT</b> <b>Power Mode</b>	Selects how to supply power through the DC OUT jack.	79	
Network	<b>Information</b>	Displays the network information on the unit.	80	
	<b>IP Address</b>	Configures the network parameters (such as IP address).	80	
	<b>MAC Address Filter</b>	Sets the MAC address filter to limit access to the unit from other network devices.	81	
	<b>DMC Control</b>	Selects whether to allow a DLNA-compatible Digital Media Controller (DMC) to control playback.	81	
	<b>Network Standby</b>	Selects whether to enable/disable the function that turns on the unit from other network devices.	81	
	<b>Network Name</b>	Edits the network name (the unit's name on the network) displayed on other network devices.	81	
	<b>Network Update</b>	Updates the firmware via the network.	82	
Language		Select an on-screen menu language.	82	

# Speaker

Configures the speaker settings manually.

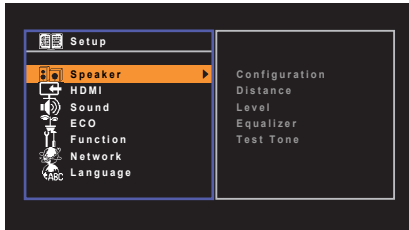

## ■ Configuration

Configures the output characteristics of the speakers.



- When you configure the speaker size, select “Large” if the woofer diameter of your speaker is 16 cm (6-1/4”) or larger or “Small” if it is smaller than 16 cm (6-1/4”).

## □ Power Amp Assign

(RX-V575 only)

Selects a speaker system.

In addition to the 5.1- or 7.1-channel speaker system, various speaker configurations are possible using the Zone B speakers or bi-amp connection.

### Settings

Basic (default)	Select this option when you use a normal speaker system (not using Zone B speakers or a bi-amp connection).
BI-AMP	Select this option when you connect front speakers that support bi-amp connections (p. 16).
Zone B	Select this option when you use Zone B speakers (p.61) in addition to the speaker system in the main zone (Zone A).

## □ Subwoofer

Selects whether or not a subwoofer is connected.

### Settings

Use (default)	Select this option when a subwoofer is connected. The subwoofer will produce LFE (low-frequency effect) channel audio and low-frequency components from other channels.
None	Select this option when no subwoofer is connected. The front speakers will produce LFE (low-frequency effect) channel audio and low-frequency components from other channels.

## □ Front

Selects the size of the front speakers.

### Settings

Small (default)	Select this option for small speakers. The subwoofer will produce front channel low-frequency components (configurable in “Crossover”).
Large	Select this option for large speakers. The front speakers will produce all of the front channel frequency components.



- “Front” is automatically set to “Large” when “Subwoofer” is set to “None”.

## □ Center

Selects whether or not a center speaker is connected and its size.

### Settings

Small (default)	Select this option for small speakers. The subwoofer or front speakers will produce center channel low-frequency components (configurable in “Crossover”).
Large	Select this option for large speakers. The center speaker will produce all of the center channel frequency components.
None	Select this option when no center speaker is connected. The front speakers will produce center channel audio.

## ❑ Surround

Selects whether or not surround speakers are connected and their sizes.

### Settings

Small (default)	Select this option for small speakers. The subwoofer or front speakers will produce surround channel low-frequency components (configurable in "Crossover").
Large	Select this option for large speakers. The surround speakers will produce all of the surround channel frequency components.
None	Select this option when no surround speakers are connected. The front speakers will produce surround channel audio. Virtual CINEMA DSP works when you select a sound program.

## ❑ Surround Back

(RX-V575 only)

Selects whether or not surround back speakers are connected and their sizes.

### Settings

Small x1	Select this option when one small speaker is connected. The subwoofer or front speakers will produce surround back channel low-frequency components (configurable in "Crossover").
Small x2 (default)	Select this option when two small speakers are connected. The subwoofer or front speakers will produce surround back channel low-frequency components (configurable in "Crossover").
Large x1	Select this option when one large speaker is connected. The surround back speaker will produce all of the surround back channel frequency components.
Large x2	Select this option when two large speakers are connected. The surround back speakers will produce all of the surround back channel frequency components.
None	Select this option when no surround back speakers are connected. The surround speakers and subwoofer (or front speakers) will produce surround back channel audio.



- "Surround Back" is automatically set to "None" when "Power Amp Assign" is set to "BI-AMP" or "Zone B", or when "Surround" is set to "None".

## ❑ Crossover

Sets the lower limit of the low-frequency components that can be output from a speaker whose size is set to "Small". A frequency sound lower than the specified value will be produced from the subwoofer or front speakers.

### Settings

40 Hz, 60 Hz, 80 Hz (default), 90 Hz, 100 Hz, 110 Hz, 120 Hz, 160 Hz, 200 Hz



- If the volume and crossover frequency are adjustable on your subwoofer, set the volume to half and crossover frequency to maximum.

## ❑ Subwoofer Phase

Sets the phase of the subwoofer. When the bass sound is lacking or unclear, switch the subwoofer phase.

### Settings

Normal (default)	Does not reverse the subwoofer phase.
Reverse	Reverses the subwoofer phase.

## ❑ Extra Bass

Sets the speakers to produce the front channel low-frequency components.

### Settings

Off (default)	Depending on the size of the front speakers, either the subwoofer or front speakers produce the front channel low-frequency components.
On	Both the front speakers and subwoofer produce the front channel low-frequency components.



- This setting is not available when "Subwoofer" is set to "None", or when "Front" is set to "Small".



## Distance

Sets the distance between each speaker and listening position so that sounds from the speakers reach the listening position at the same time. First, select the unit of distance from "Meter" or "Feet".

### Choices

Front L, Front R, Center, Surround L, Surround R, Surround Back L (RX-V575 only), Surround Back R (RX-V575 only), Subwoofer

### Setting range

0.30 m to 24.00 m (1.0 ft to 80.0 ft), \*0.05 m (0.2 ft) increments

### Default

Front L, Front R, Subwoofer: 3.00 m (10.0 ft)  
Center: 2.60 m (8.6 ft)  
Others: 2.40 m (8.0 ft)

## Level

Adjusts the volume of each speaker.

### Choices

Front L, Front R, Center, Surround L, Surround R, Surround Back L (RX-V575 only), Surround Back R (RX-V575 only), Subwoofer

### Setting range

-10.0 dB to +10.0 dB (0.5 dB increments)

### Default

Front L, Front R, Subwoofer: 0.0 dB  
Others: -1.0 dB

## Equalizer

Adjusts the tone with an equalizer.

### EQ Select

Selects the type of equalizer to be used.

#### Settings

PEQ	Applies the parametric equalizer values obtained by the YPAO measurement (p.31).
GEQ (default)	Select this option when you want to adjust the equalizer manually. For details, see "Manual equalizer adjustment".
Off	Does not use the equalizer.



- "PEQ" is available only when the YPAO has been performed (p.31).

### Manual equalizer adjustment

- 1 Set "EQ Select" to "GEQ".
- 2 Use the cursor keys ( $\Delta/\nabla$ ) to select "Channel" and the cursor keys ( $\leftarrow/\rightarrow$ ) to select the desired speaker channel.
- 3 Use the cursor keys ( $\Delta/\nabla$ ) to select the desired band (frequency) and the cursor keys ( $\leftarrow/\rightarrow$ ) to adjust the gain.

#### Setting range

-6.0 dB to +6.0 dB

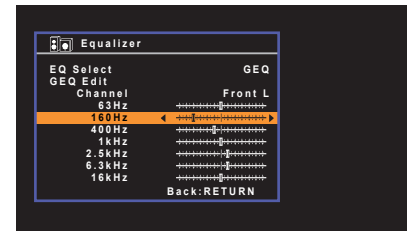

- 4 To exit from the menu, press **SETUP**.

## Test Tone

Enables/disables the test tone output. Test tone output helps you to adjust the speaker balance or equalizer while confirming its effect.

#### Settings

Off (default)	Does not output test tones.
On	Outputs test tones automatically when you adjust the speaker balance or equalizer.

# HDMI

Configures the HDMI settings.

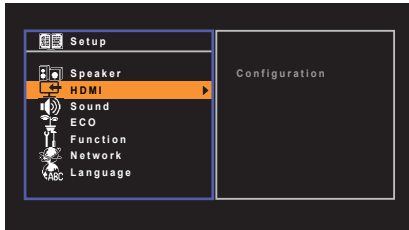

## Configuration

### □ HDMI Control

Enables/disables HDMI Control (p.100).

#### Settings

Off (default)	Disables HDMI Control.
On	Enables HDMI Control. Configure the settings in "TV Audio Input", "Standby Sync", "ARC", and "SCENE".



- To use HDMI control, you need to perform the HDMI Control link setup (p.100) after connecting HDMI Control-compatible devices.

### □ Audio Output

Selects a device to output audio.



- This setting is available only when "HDMI Control" is set to "Off".

### Amp

Enables/disables the audio output from the speakers connected to the unit.

#### Settings

Off	Disables the audio output from the speakers.
On (default)	Enables the audio output from the speakers.

### HDMI OUT (TV)

Enables/disables the audio output from a TV connected to the HDMI OUT jack.

#### Settings

Off (default)	Disables the audio output from the TV.
On	Enables the audio output from the TV.

### □ Standby Through

Select whether to output videos/audio (input through HDMI jacks) to the TV when the unit is in standby mode. If this function is set to "On", you can use the input selection keys (HDMI 1–5) to select an HDMI input even when the unit is in standby mode (the standby indicator on the unit blinks).

#### Settings

Off (default)	Does not output videos/audio to the TV.
On	Outputs videos/audio to the TV. (The unit consumes more power than when "Off" is selected.)



- This setting is available only when "HDMI Control" is set to "Off".

### □ TV Audio Input

Selects an audio input jack of the unit to be used for TV audio input when "HDMI Control" is set to "On". The unit's input source automatically switches to TV audio when the TV input is switched to its built-in tuner.

#### Settings

AV 1–6, AUDIO

#### Default

AV 4



- When using ARC to input TV audio to the unit, you cannot use the input jacks selected here for connecting an external device because the input will be used for TV audio input.

## ❑ Standby Sync

Select whether to use HDMI control to link the standby behavior of the TV and the unit when "HDMI Control" is set to "On".

### Settings

Off	Does not set the unit to standby mode when the TV is turned off.
On	Sets the unit to standby mode when the TV is turned off.
Auto (default)	Sets the unit to standby mode when the TV is turned off only when the unit is receiving TV audio or HDMI signals.

## ❑ ARC

Enables/disables ARC (p.18) when "HDMI Control" is set to "On".

### Settings

Off	Disables ARC.
On (default)	Enables ARC.



- You do not need to change this setting normally. In case noises are produced from the speakers connected to the unit because TV audio signals input to the unit via ARC are not supported by the unit, set "ARC" to "Off" and use the TV's speakers.

## ❑ SCENE

Enables/disable SCENE link playback when "HDMI Control" is set to "On".

When SCENE link playback is enabled, HDMI Control-compatible devices connected to the unit via HDMI automatically works as follows, with a scene selection.

- TV: turning on and displaying video from the playback device
- Playback device: starting playback

### Choices (SCENE keys)

BD/DVD, TV, NET, RADIO

### Settings

Off	Disables SCENE link playback for the selected SCENE key.
On	Enables SCENE link playback for the selected SCENE key.

### Default

BD/DVD, TV: On  
NET, RADIO: Off



- SCENE link playback may not work properly due to the compatibility between devices. We recommend using TV and playback devices from the same manufacturer so that HDMI Control works more effectively.

## Sound

Configures the audio output settings.

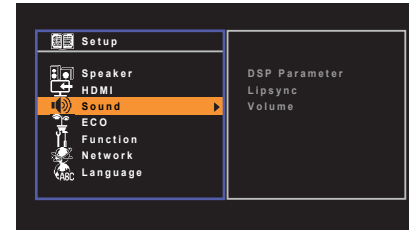

## ■ DSP Parameter

Configures the surround decoder settings.

## ❑ CINEMA DSP 3D Mode

Enables/disables CINEMA DSP 3D (p.40). If this function is set to "On", CINEMA DSP 3D functions with the selected sound programs (except 2ch Stereo and 7ch/5ch Stereo).

### Settings

Off	Disables CINEMA DSP 3D.
On (default)	Enables CINEMA DSP 3D.

## ❑ Panorama

Enables/disables the broadening effect of the front sound field. When this function is enabled, you can wrap front right/left channel sounds around the field and generate a spacious sound field in combination with the surround sound field. This setting is effective when "❑PLII Music" or "❑PLIIX Music" (RX-V575 only) is selected.

### Settings

Off (default)	Disables the broadening effect of the front sound field.
On	Enables the broadening effect of the front sound field.

## □ Center Width

Adjusts the broadening effect of the center sound field. Higher to enhance the broadening effect, and lower to reduce it (closer to center). This setting is effective when "□PLII Music" or "□PLIIX Music" (RX-V575 only) is selected.

### Setting range

0 to 7

### Default

3

## □ Dimension

Adjusts the difference in level between the front and surround sound fields. Higher to strengthen the front sound field and lower to strengthen the surround sound field. This setting is effective when "□PLII Music" or "□PLIIX Music" (RX-V575 only) is selected.

### Setting range

-3 to +3

### Default

0

## □ Center Image

Adjusts the center orientation level (broadening effect) of the front sound field. Higher to strengthen the center orientation level (less broadening effect) and lower to weaken (more broadening effect). This setting is effective when "Neo:6 Music" is selected.

### Setting range

0.0 to 1.0

### Default

0.3

## ■ Lipsync

Adjusts the delay between video and audio output.



- You can enable/disable the Lipsync function by input sources in "Lipsync" (p.66) in the "Option" menu.

## □ Select

Selects the method to adjust the delay between video and audio output.

### Setting range

Manual	Select this option when you want to adjust the delay between video and audio output manually. Adjust the audio output timing in "Adjustment".
Auto (default)	Adjusts the delay between video and audio output automatically when a TV that supports an automatic lipsync function is connected to the unit via HDMI. If necessary, you can fine-adjust the audio output timing in "Adjustment".



- "Select" is automatically set to "Manual" depending on the TV connected to the unit.

## □ Adjustment

Adjusts the delay between video and audio output manually when "Select" is set to "Manual". You can fine-adjust the audio output timing when "Select" is set to "Auto".

### Setting range

0 ms to 250 ms (1 ms increments)

### Default

0 ms

## ■ Volume

Configures the volume settings.

### □ Dynamic Range

Selects the dynamic range adjustment method for bitstream audio (Dolby Digital and DTS signals) playback.

#### Settings

Maximum (default)	Produces audio without adjusting the dynamic range.
Standard	Optimizes the dynamic range for regular home use.
Min/Auto	Sets the dynamic range for clear sound even at night or at low volumes. When playing back Dolby TrueHD signals, the dynamic range is automatically adjusted based on the input signal information.

### □ Max Volume

Sets the maximum volume to prevent excessive loudness.

#### Setting range

-30.0 dB to +15.0 dB (5.0 dB increments), +16.5 dB

#### Default

+16.5 dB

### □ Initial Volume

Sets the initial volume when the receiver is turned on.

#### Settings

Off (default)	Sets the level to the volume level of the unit when it last entered standby mode.
Mute	Sets the unit to mute the audio output.
-80.0 dB to +16.5 dB (0.5 dB increments)	Sets the level to the specified volume level.

### □ ZoneB Volume

(RX-V575 only)

Selects whether to adjust the volume for Zone B in conjunction with the volume for Zone A.

#### Settings

Sync. (default)	Adjusts the volume for Zone B in conjunction with the volume for Zone A.
Async.	Does not adjust the volume for Zone B in conjunction with the volume for Zone A. Adjust the volume for Zone B separately (p.62).



- If "ZoneB Volume" is set to "Async.", the volume for Zone B is temporarily set to -40 dB. As necessary, adjust the volume using the remote control (p.62).

## ECO

Configures the power supply settings.

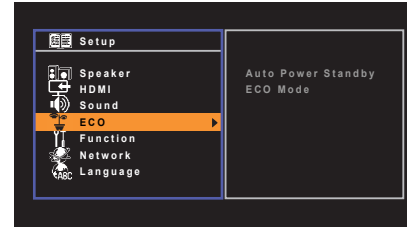

## ■ Auto Power Standby

Sets the amount of time for the auto-standby function. If you do not operate the unit for the specified time, the unit will automatically go into standby mode.

#### Settings

Off	Does not set the unit to standby mode automatically.
2 hours, 4 hours, 8 hours, 12 hours	Sets the unit to standby mode when you have not operated the unit for the specified time. For example, when "2 hours" is selected, the unit will switch to standby mode if you do not operate it for 2 hours.

#### Default

U.K. and Europe models: 8 hours

Other models: Off



- Just before the unit enters standby mode, "AutoPowerStdby" appears and then countdown starts in the front display.

## ECO Mode

Enables/disables the eco (power saving) mode.

When the eco mode is enabled, you can reduce the unit's power consumption.

### Settings

Off (default)	Disables the eco mode.
On	Enables the eco mode.



- Be sure to press ENTER to restart the unit after selecting a setting. The new setting will take effect after the unit is restarted.
- When "ECO Mode" is set to "On", the front panel display may become dark.
- If you want to play audio at high volume, set "ECO Mode" to "Off".

## Function

Configures the functions that make the unit easier to use.

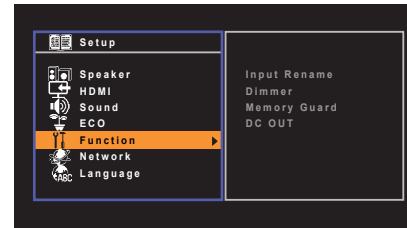

## Input Rename

Changes the input source name displayed on the front display.

### Input sources

HDMI 1-5, AV 1-6, AUDIO, USB, V-AUX

### Procedure

- 1 Use the cursor keys ( $\Delta/\nabla$ ) to select an input source to be renamed and press ENTER.



- To select a name from the presets, use the cursor keys ( $\Delta/\nabla$ ) to select an input source and the cursor keys ( $\leftarrow/\rightarrow$ ) to select a preset name.

- 2 Use the cursor keys ( $\leftarrow/\rightarrow$ ) to move the edit position and the cursor keys ( $\Delta/\nabla$ ) to select a character.

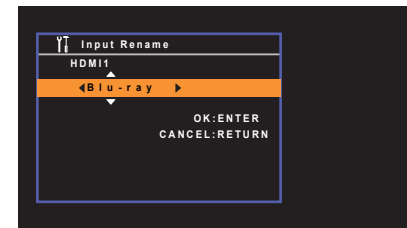

- 3 To confirm the new name, press ENTER.



- To cancel the entry, press RETURN.

4 To change another input source name, repeat steps 1 to 3.

5 To exit from the menu, press **SETUP**.

## ■ Dimmer

Adjusts the brightness of the front display.

### Setting range

-4 to 0 (higher to brighten)

### Default

0



- The front display may become dark when "ECO Mode" (p.78) is set to "On".

## ■ Memory Guard

Prevents accidental changes to the settings.

### Settings

Off (default)	Does not protect the settings.
On	Protects the settings until "Off" is selected.



- When "Memory Guard" is set to "On", the lock icon (🔒) is displayed on the menu screen.

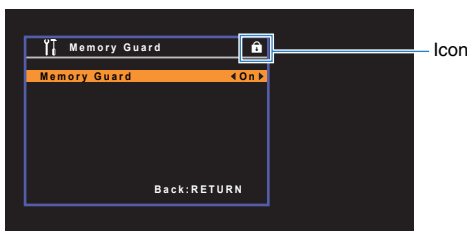

## ■ DC OUT

Configures the DC OUT jack setting.

### □ Power Mode

Selects how to supply power to the Yamaha AV accessory connected to the DC OUT jack.

### Settings

Continuous (default)	Supplies power through the DC OUT jack continuously regardless of the power state (on/standby) of the unit.
Power Sync.	Supplies power through the DC OUT jack only when the unit is turned on.

# Network

Configures the network settings.

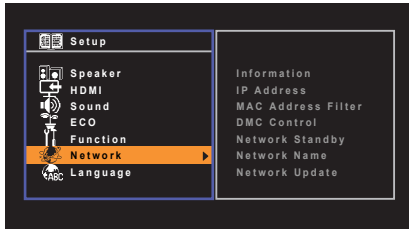

## Information

Displays the network information on the unit.

Status	The connection status of the NETWORK jack
MAC Address	MAC address
IP Address	IP address
Subnet Mask	Subnet mask
Default Gateway	The IP address of the default gateway
DNS Server (P)	The IP address of the primary DNS server
DNS Server (S)	The IP address of the secondary DNS server
vTuner ID	The ID of the Internet radio (vTuner)

## IP Address

Configures the network parameters (such as IP address).

### DHCP

Select whether to use a DHCP server.

#### Settings

Off	Does not use a DHCP server. Configure the network parameters manually. For details, see "Manual network settings".
On (default)	Uses a DHCP server to automatically obtain the unit's network parameters (such as IP address).

### Manual network settings

- 1 Set "DHCP" to "Off".
- 2 Use the cursor keys ( $\Delta/\nabla$ ) to select a parameter type.

IP Address	Specifies an IP address.
Subnet Mask	Specifies a subnet mask.
Default Gateway	Specifies the IP address of the default gateway.
DNS Server (P)	Specifies the IP address of the primary DNS server.
DNS Server (S)	Specifies the IP address of the secondary DNS server.

- 3 Use the cursor keys ( $\leftarrow/\rightarrow$ ) to move the edit position and the cursor keys ( $\Delta/\nabla$ ) to select a value.
- 4 To exit from the menu, press **SETUP**.



## ■ MAC Address Filter

Sets the MAC address filter to limit access to the unit from other network devices.

### □ Filter

Enables/disables the MAC address filter.

#### Settings

Off (default)	Disables the MAC address filter.
On	Enables the MAC address filter. In "MAC Address 1-10", specify the MAC addresses of the network devices that will be permitted access to the unit.

### □ MAC Address 1-10

Specifies the MAC addresses (up to 10) of the network devices that will be permitted access to the unit when "Filter" is set to "On".

#### ■ Procedure

- 1 Use the cursor keys ( $\Delta/\nabla$ ) to select an MAC address number (1 to 10).
- 2 Use the cursor keys ( $\leftarrow/\rightarrow$ ) to move the edit position and the cursor keys ( $\Delta/\nabla$ ) to select a value.
- 3 To exit from the menu, press **SETUP**.

## ■ DMC Control

Selects whether to allow DLNA-compatible Digital Media Controller (DMC) to control playback.

#### Settings

Disable	Does not allow DMCs to control playback.
Enable (default)	Allows DMCs to control playback.



- A Digital Media Controller (DMC) is a device that can control other network devices through the network. When this function is enabled, you can control playback of the unit from DMCs (such as Windows Media Player 12) on the same network.

## ■ Network Standby

Selects whether the unit can be turned on from other network devices (network standby).

#### Settings

Off (default)	Disables the network standby function.
On	Enables the network standby function. (The unit consumes more power than when "Off" is selected.)

## ■ Network Name

Edits the network name (the unit's name on the network) displayed on other network devices.

#### ■ Procedure

- 1 Press **ENTER** to enter the name edit screen.
- 2 Use the cursor keys ( $\leftarrow/\rightarrow$ ) to move the edit position and the cursor keys ( $\Delta/\nabla$ ) to select a character.

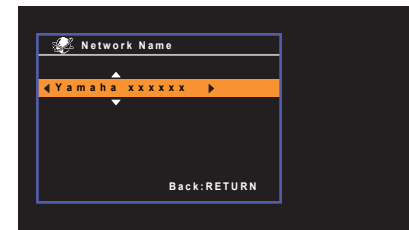

- 3 To confirm the new name, press **ENTER**.
- 4 To exit from the menu, press **SETUP**.

## ■ Network Update

Updates the firmware via the network.

### □ Perform Update

Starts the process to update the unit's firmware. For details, see "Updating the unit's firmware" (p.88).

### □ Firmware Version

Displays the version of the firmware installed on the unit.

### □ System ID

Displays the system ID number.

## Language

Select an on-screen menu language.



### Settings

English (default)	English
日本語	Japanese
Français	French
Deutsch	German
Español	Spanish
Русский	Russian
Italiano	Italian
中文	Chinese





- Japanese and Chinese characters used in content information (such as song titles) cannot be displayed.
- The information on the front display is provided in English only.

## Configuring the system settings (ADVANCED SETUP menu)

Configure the system settings of the unit while viewing the front display.

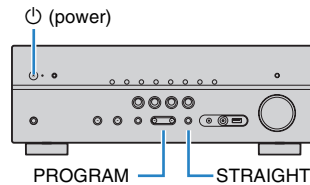
- 1 Set the unit to standby mode.
- 2 While holding down STRAIGHT on the front panel, press  (power).



- 3 Press PROGRAM to select an item.
- 4 Press STRAIGHT to select a setting.
- 5 Press  (power) to set the unit to standby mode and turn it on again.  
The new settings take effect.

### ADVANCED SETUP menu items

Item	Function	Page
SP IMP.	(U.S.A. and Canada models only) Changes the speaker impedance setting.	83
REMOTE ID	Selects the unit's remote control ID.	83
TU	(Asia and General models only) Changes the FM/AM tuning frequency setting.	84
TV FORMAT	Switches the video signal type of HDMI output.	84
INIT	Restores the default settings.	84
UPDATE	Updates the firmware.	84
VERSION	Checks the version of firmware currently installed on the unit.	84

## Changing the speaker impedance setting (SP IMP.)

(U.S.A. and Canada models only)



Change the unit's speaker impedance settings depending on the impedance of the speakers connected.

#### Settings

6 Ω MIN	Select this option when you connect 6-ohm speakers to the unit. You can also use 4-ohm speakers as the front speakers.
8 Ω MIN (default)	Select this option when you connect 8-ohm or higher speakers to the unit.

## Selecting the remote control ID (REMOTE ID)





Change the unit's remote control ID so that it matches the remote control's ID (default: ID1). When using multiple Yamaha AV receivers, you can set each remote control with a unique remote control ID for its corresponding receiver.

#### Settings

ID1 (default), ID2

### ■ Changing the remote control ID of the remote control

- 1 To select ID1, while holding down the cursor key () , hold down SCENE (BD/DVD) for more than 3 seconds.  
To select ID2, while holding down the cursor key () , hold down SCENE (TV) for more than 3 seconds.



- The registered remote control codes (p.85) are not cleared even if you change the remote control ID.

## Changing the FM/AM tuning frequency setting (TU)

(Asia and General models only)



Change the FM/AM tuning frequency setting of the unit depending on your country or region.

### Settings

FM100/AM10	Select this when you want to adjust the FM frequency by 100-kHz steps and AM by 10-kHz steps.
FM50/AM9 (default)	Select this when you want to adjust the FM frequency by 50-kHz steps and AM by 9-kHz steps.

## Switching the video signal type (TV FORMAT)



Switch the video signal type of HDMI output so that it matches to the format of your TV. Since the unit automatically selects the video signal type so that it matches to the TV, it is unnecessary to change the setting normally. Change the setting only when images on the TV screen do not appear correctly.

### Settings

NTSC, PAL

### Default

U.S.A., Canada, Korea and General models: NTSC

Other models: PAL

## Restoring the default settings (INIT)



Restores the default settings for the unit.

### Choices

ALL	Restores the default settings for the unit.
CANCEL	Does not perform an initialization.

## Updating the firmware (UPDATE)



New firmware that provides additional features or product improvements will be released as needed. Updates can be downloaded from our website. If the unit is connected to the Internet, you can download the firmware via the network. For details, refer to the information supplied with updates.

### Firmware update procedure

Do not perform this procedure unless firmware update is necessary. Also, make sure you read the information supplied with updates before updating the firmware.

- 1 Press **STRAIGHT** repeatedly to select “USB” or “NETWORK” and press **INFO** to start firmware update.

### Choices

USB	Update the firmware using a USB memory device.
NETWORK	Update the firmware via the network.



- If the unit detects newer firmware over the network, the envelope icon (✉) will appear in the “Network Update” screen. In this case, you can also update the unit’s firmware by following the procedure in “Updating the unit’s firmware” (p.88).

## Checking the firmware version (VERSION)



Check the version of firmware currently installed on the unit.



- You can also check the firmware version in “Network Update” (p.82) in the “Setup” menu.
- It may take a while until the firmware version is displayed.



## Controlling external devices with the remote control

You can use the unit's remote control to operate external devices (such as BD/DVD players) if you have registered the remote control code of the external device.



- You cannot control an external device that does not have a remote control sensor.
- Ensure that the remote control ID of the external device is set to "ID1". If any other ID is selected, the remote control operations may not work properly.
- If the unit's remote control is without batteries for more than 2 minutes, the registered codes may be cleared. If this happens, insert new batteries and register the codes again.



- Under the unit's default settings, the amplifier code (Yamaha: 5098) is set for all the input selection keys. With this setting, you can control HDMI Control-compatible devices connected to the unit with the remote control. (This function may not work depending on the specification of the external device.)

### Registering the remote control code for a TV

You can use the unit's remote control to operate a TV if you have registered its remote control code.



- You can also register your TV's remote control code to the unit's input selection keys (p.86). This would allow you to use the cursor keys or numeric keys to operate the TV (this function may not be available on some TV models).

#### 1 Use "Remote Control Code Search" in the CD-ROM to find your TV's remote control code.



- If there are multiple remote control codes, register the first code in the list. If that does not work, try the other codes.

#### 2 Press CODE SET using a pointed object such as the tip of a ballpoint pen.

SOURCE/RECEIVER blinks twice.

Perform each of the following steps within 1 minute.

Otherwise, the setting will be canceled. If this happens, repeat from Step 2.

#### 3 Press TV

#### 4 Use the numeric keys to enter the 4-digit remote control code.

Once the remote control code is successfully registered, SOURCE/RECEIVER blinks twice.

If it blinks six times, registration has failed. Repeat from Step 2.

### TV operations

Once you have registered the remote control code for your TV, you can control it using the TV operation keys, regardless of the input source selected on the unit.

	INPUT	Switches the video inputs of the TV.
	MUTE	Mutes the audio output of the TV.
TV operation keys	TV VOL	Adjust the volume of the TV.
	TV CH	Switch the channels of the TV
	TV	Turns on/off the TV.

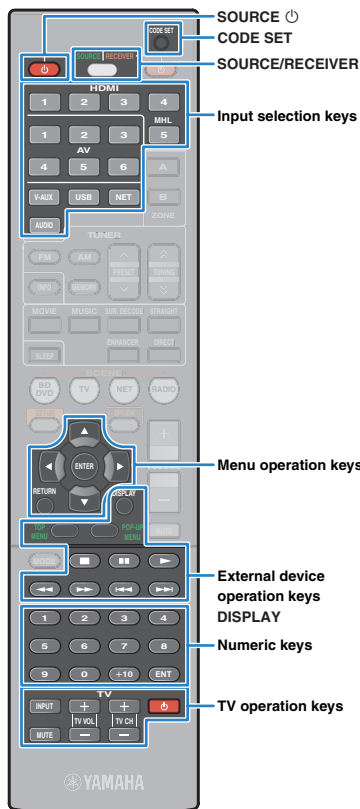

## Registering the remote control codes for playback devices

You can use the unit's remote control to operate playback devices if you have registered their remote control codes. You can also use the input selection keys to change the playback devices that are controlled by the remote control, because their remote control codes are assigned to the input selection keys.



- (RX-V475 only)  
If you assign the remote control code for an external device to the star (★ or ★★) key, you can operate the device with the remote control without switching the input source after pressing the star key.

### 1 Use “Remote Control Code Search” in the CD-ROM to find the remote control code for your playback device.



- If there are multiple remote control codes, register the first code in the list. If that does not work, try the other codes.

### 2 Press CODE SET using a pointed object such as the tip of a ballpoint pen.

SOURCE/RECEIVER blinks twice.

Perform each of the following steps within 1 minute. Otherwise, the setting will be canceled. If this happens, repeat from Step 2.

### 3 Press the input selection key.

For example, press HDMI 1 to set the remote control code for the playback device connected to the HDMI 1 jack.

### 4 Use the numeric keys to enter the 4-digit remote control code.

Once the remote control code is registered successfully, SOURCE/RECEIVER blinks twice.

If it blinks six times, registration has failed. Repeat from Step 2.



- For details on how to register a remote control code to a SCENE key, refer to “Configuring scene assignments” (p.36).

## Playback device operations

Once you have registered the remote control code for your playback device, you can control it using the following keys after selecting the input source or scene.



- By pressing SOURCE/RECEIVER, you can switch the devices (the unit or external device) that are operated by the menu operation keys, DISPLAY and numeric keys. You can operate the unit when SOURCE/RECEIVER lights up in orange, and an external device when SOURCE/RECEIVER lights up in green. For example, if you register the remote control code of your BD/DVD player on HDMI 1, you can operate the unit when SOURCE/RECEIVER lights up in orange, and the BD/DVD player when SOURCE/RECEIVER lights up in green.

SOURCE		Turns on/off the playback device.
Menu operation keys	Cursor keys	Select an item.
	ENTER	Confirms a selected item.
	RETURN	Returns to the previous screen.
DISPLAY		Switches information on the display.
External device operation keys	TOP MENU	Displays the top menu.
	POP-UP MENU	Displays the pop-up menu.
		Stops playback.
		Stops playback temporarily.
		Starts playback of the selected song/video.
		Searches forward/backward (by holding down).
		Skips forward/backward.
Numeric keys		Enter numerical values.
TV operation keys		Control the TV (p.85).



- These keys work only if the corresponding function is available on your playback device and if the device can be operated with an infrared remote control.



## Resetting remote control codes

You can reset a remote control code registered to each input selection key.

### 1 Press CODE SET using a pointed object such as the tip of a ballpoint pen.

SOURCE/RECEIVER blinks twice.

Perform each of the following steps within 1 minute. Otherwise, the setting will be canceled. If this happens, repeat from Step 1.

### 2 Press the input selection key.

### 3 Use the numeric keys to enter "5098".

Once the remote control code is reset successfully, SOURCE/RECEIVER blinks twice.

If it blinks six times, resetting has failed. Repeat from Step 1.

#### To reset the remote control to factory default settings

- ① Press CODE SET using a pointed object such as the tip of a ballpoint pen.
- ② Press SOURCE/RECEIVER.
- ③ Use the numeric keys to enter "9981".

## Updating the unit's firmware via the network

New firmware that provides additional features or product improvements will be released as needed. If the unit is connected to the Internet, you can download the firmware via the network and update it.

### Note

- Do not operate the unit or disconnect the power cable or network cable during firmware update. Firmware update takes about 20 minutes or more (depending on your Internet connection speed).
- If the unit is connected to the wireless network via a wireless network adapter, network update may not be possible depending on the condition of the wireless connection. In this case, update the firmware using the USB memory device (p.84).
- To perform the following procedure, your TV must be connected to the unit via HDMI. If not, perform the update from the "ADVANCED SETUP" menu (p.84).



- You can also update the firmware using the USB memory device from the "ADVANCED SETUP" menu (p.84).

- 1 Press SETUP.**
- 2 Use the cursor keys to select "Network" and press ENTER.**
- 3 Use the cursor keys to select "Network Update" and press ENTER.**

If new firmware is available, the envelope icon (✉) appears in the "Network Update" screen.

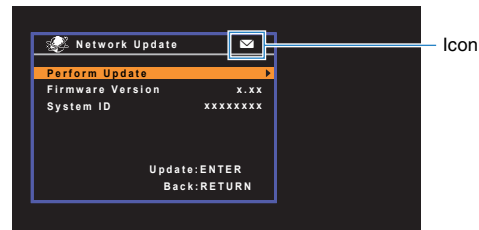

- To cancel the operation without updating the firmware, press SETUP.

- 4 Use the cursor keys to select "Perform Update" and press ENTER.**

The on-screen display turns off and the firmware update starts.

- 5 If "UPDATE SUCCESS PLEASE POWER OFF!" appears on the front display, press  (power) on the front panel.**

The firmware update is complete.

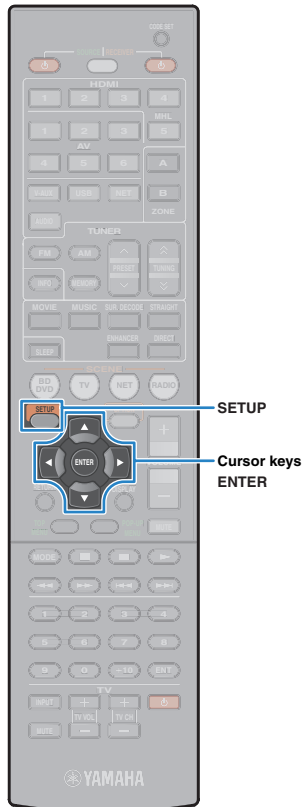



# APPENDIX

## Frequently asked questions

### **The new speaker system does not provide an ideal sound balance...**

If you have changed speakers or have a new speaker system, use YPAO to optimize the speaker settings again (p.31). If you want to adjust the speaker settings manually, use "Speaker" in the "Setup" menu (p.71).

### **Since we have small children, we want to set limitations on the volume control...**

If a small child accidentally operates the controls on the main unit or remote control, the volume may suddenly increase. This may also cause injury or damage the unit or speakers. We recommend using "Max Volume" in the "Setup" menu to set the maximum volume level for the unit in advance (p.77).

### **I am occasionally startled by a sudden loud sound when turning on the unit...**

By default, the volume level when the unit last entered standby mode is automatically applied. If you want to fix the volume, use "Initial Volume" in the "Setup" menu to set the volume to be applied when the receiver is turned on (p.77).

### **We are bothered by volume differences when switching between input sources...**

You can correct volume differences between input sources by utilizing "Input Trim" in the "Option" menu (p.66).

### **I made HDMI connections but HDMI Control does not work at all...**

To use HDMI Control, you need to perform the HDMI Control link setup (p.100). After connecting HDMI Control-compatible devices (such as BD/DVD players) to the unit, enable HDMI Control on each device and perform the HDMI Control link setup. This setup is required every time you add a new HDMI Control-compatible device to your

system. For information on how HDMI Control works between your TV and playback devices, refer to the instruction manuals for each device.

### **I want to display a device name or a manufacture name on the front display when selecting an input source...**

By default, input source names (such as "HDMI 1" and "AV 1") are displayed on the front display when an input source is selected. If you want to rename them as you like, use "Input Rename" (p.78) in the "Setup" menu. You can also select a name from the presets (such as "Blu-ray" and "DVD").

### **I want to prevent accidental changes to the settings...**

You can protect the settings configured on the unit (such as speaker settings) by utilizing "Memory Guard" in the "Setup" menu (p.79).

### **The unit's remote control is simultaneously controlling another Yamaha product as well as the unit...**

When using multiple Yamaha products, the remote control may work on another Yamaha product or another remote control may work on the unit. If this happens, register different remote control IDs for the devices that you want to control with each remote control (p.83).

### **I want to enjoy videos/audio played back on the video device even when the unit is in standby mode...**

If you have connected a video device to the unit with HDMI, you can output videos/audio played back on the video device to the TV even when the unit is in standby mode. To use this function, set "Standby Through" (p.74) in the "Setup" menu to "On". You can also switch the input source using the remote control of the unit when this function is enabled.

## Troubleshooting

Refer to the table below when the unit does not function properly.

If the problem you are experiencing is not listed below or if the instructions below do not help, turn off the unit, disconnect the power cable, and contact the nearest authorized Yamaha dealer or service center.

### First, check the following:

- ① **The power cables of the unit, TV and playback devices (such as BD/DVD players) are connected to AC wall outlets securely.**
- ② **The unit, subwoofer, TV and playback devices (such as BD/DVD players) are turned on.**
- ③ **The connectors of each cable are securely inserted in to jacks on each device.**

### Power, system and remote control

Problem	Cause	Remedy
<b>The power does not turn on.</b>	The protection circuitry has been activated three times consecutively. If the unit is in this condition, the standby indicator on the unit blinks when you try to turn on the power.	As a safety precaution, capability to turn on the power is disabled. Contact your nearest Yamaha dealer or service center to request repair.
<b>The power does not turn off.</b>	The internal microcomputer has frozen, due to an external electric shock (such as lightning or excessive static electricity) or to a drop in the power supply voltage.	Hold down $\odot$ (power) on the front panel for more than 10 seconds to initialize and reboot the unit. (If the problem persists, disconnect the power cable from the AC wall outlet and plug it again.)
<b>The power turns off (standby mode) immediately.</b>	The unit was turned on while a speaker cable was shorted.	Twist the bare wires of each speaker cable firmly and reconnect to the unit and speakers (p.16).
<b>The unit enters standby mode automatically.</b>	The sleep timer worked.	Turn on the unit and start playback again.
	The auto-standby function kicked in because the unit was not used for the specified time.	To disable the auto-standby function, set "Auto Power Standby" in the "Setup" menu to "Off" (p.77).
	The speaker impedance setting is incorrect.	Set the speaker impedance to match your speakers (p.83).
	The protection circuitry has been activated because of a short circuit.	Twist the bare wires of each speaker cable firmly and reconnect to the unit and speakers (p.16).
<b>The unit is not reacting.</b>	The internal microcomputer is frozen, due to an external electric shock (such as lightning or excessive static electricity) or to a drop in the power supply voltage.	Hold down $\odot$ (power) on the front panel for more than 10 seconds to initialize and reboot the unit. (If the problem persists, disconnect the power cable from the AC wall outlet and plug it again.)

Problem	Cause	Remedy
<b>The unit cannot be controlled using the remote control.</b>	The unit is out of the operating range.	Use the remote control within the operating range (p.4).
	The batteries are weak.	Replace with new batteries.
	The unit's remote control sensor is exposed to direct sunlight or strong lighting.	Adjust the lighting angle, or reposition the unit.
	The remote control is set to control external devices.	Press SOURCE/RECEIVER to set the remote control to control the unit (the key lights up in orange).
	The remote control IDs of the unit and the remote control are not identical.	Change the remote control ID of the unit or the remote control (p.83).
	The remote control is set to the Zone B operation mode.	Set the remote control to the Zone A operation mode (p.62).
<b>External devices cannot be controlled using the remote control.</b>	The remote control is set to control the unit.	Press SOURCE/RECEIVER to set the remote control to control external devices (the key lights up in green).
	The corresponding remote control code is not set properly.	Set the remote control code again (p.85). Even if the remote control code is registered properly, some products may not respond to the remote control.
<b>The MHL-compatible mobile device cannot be controlled using the remote control.</b>	A remote control code for another playback device is assigned to HDMI 5.	Reset the remote control code registered to HDMI 5 (p.87).
	The mobile device or its application is not externally controllable.	Directly operate the mobile device itself.

# Audio

Problem	Cause	Remedy
<b>No sound.</b>	Another input source is selected.	Select an appropriate input source with the input selection keys.
	Signals that the unit cannot reproduce are being input.	Some digital audio formats cannot be played back on the unit. To check the audio format of the input signal, use "Signal Info" in the "Option" menu (p.66).
	(RX-V575 only) Audio output to Zone A (or Zone B) is disabled.	Press ZONE A (ZONE B) to enable audio output to Zone A (or Zone B).
	The cable connecting the unit and playback device is defective.	If there is no problem with the connection, replace with another cable.
<b>The volume cannot be increased.</b>	The maximum volume is set.	Use "Max Volume" in the "Setup" menu to adjust the maximum volume (p.77).
	A device connected to the output jacks of the unit is not turned on. (This may happen due to the nature of AV receivers.)	Turn on all devices connected to the output jacks of the unit.
<b>No sound is coming from a specific speaker.</b>	The playback source does not contain a signal for the channel.	To check it, use "Signal Info" in the "Option" menu (p.66).
	The currently selected sound program/decoder does not use the speaker.	To check it, use "Test Tone" in the "Setup" menu (p.73).
	Audio output of the speaker is disabled.	Perform YPAO (p.31) or use "Configuration" in the "Setup" menu to change the speaker settings (p.71).
	The volume of the speaker is set too low.	Perform YPAO (p.31) or use "Level" in the "Setup" menu to adjust the speaker volume (p.73).
	(RX-V575 only) Audio output to Zone A (or Zone B) is disabled.	Press ZONE A (ZONE B) to enable audio output to Zone A (or Zone B).
	The speaker cable connecting the unit and the speaker is defective.	If there is no problem with the connection, replace with another speaker cable.
	The speaker is malfunctioning.	To check it, replace with another speaker. If the problem persists, the unit may be malfunctioning.
<b>(RX-V575 only) No sound is coming from the surround back speaker.</b>	The extended surround is disabled.	Use "Extended Surround" in the "Option" menu to select a decoder to be used (p.65).
	"Power Amp Assign" is set to "BI-AMP" or "Zone B".	When "Power Amp Assign" in the "Setup" menu is set to "BI-AMP" or "Zone B", you cannot use the surround back speakers. To use the surround back speakers, set "Power Amp Assign" to "Basic" (p.71).
<b>No sound is coming from the subwoofer.</b>	The playback source does not contain LFE or low-frequency signals.	To check it, set "Extra Bass" in the "Setup" menu to "On", in order to output the front channel low-frequency components from the subwoofer (p.72).
	Subwoofer output is disabled.	Perform YPAO (p.31) or set "Subwoofer" in the "Setup" menu to "Use" (p.71).
	The volume of the subwoofer is too low.	Adjust the volume on the subwoofer.
	The subwoofer has been turned off by its auto-standby function.	Disable the auto-standby function of the subwoofer or adjust its sensitivity level.

Problem	Cause	Remedy
<b>No sound from the playback device (connected to the unit with HDMI).</b>	The TV does not support HDCP (High-bandwidth Digital Content Protection).	Refer to the instruction manuals for the TV and check the TV's specifications.
	The unit is set not to output audio input through HDMI jacks from the SPEAKERS terminals.	In "Audio Output" in the "Setup" menu, set "Amp" to "On" (p.74).
	The number of devices connected to the HDMI OUT jack exceeds the limit.	Disconnect some of the HDMI devices.
<b>No sound from the TV (when HDMI Control is used).</b>	The TV is set to output audio from the TV speakers.	Change the audio output setting on your TV so that the TV audio is output from the speakers connected to the unit.
	A TV that does not support ARC is connected to the unit only with an HDMI cable.	Use a digital optical cable to make an audio connection (p.20).
	(If the TV is connected to the unit with an audio cable) The TV audio input setting does not match the actual connection.	Use "TV Audio Input" in the "Setup" menu to select the correct audio input jack (p.74).
	(If you are trying to use ARC) ARC is disabled on the unit or TV.	Set "ARC" in the "Setup" menu to "On" (p.75). Also, enable ARC on the TV.
<b>Only the front speakers work on multichannel audio.</b>	The playback device is set to output 2-channel audio (such as PCM) only.	To check it, use "Signal Info" in the "Option" menu (p.66). If necessary, change the digital audio output setting on the playback device.
<b>Noise/hum is heard.</b>	The unit is too close to another digital or radio frequency device.	Move the unit further away from the device.
	The cable connecting the unit and playback device is defective.	If there is no problem with the connection, replace with another cable.
<b>The sound is distorted.</b>	The volume of the unit is too high.	Turn down the volume. If "ECO Mode" is set to "On", set it to "Off" (p.78).
	A device connected to the unit's output jacks is not turned on.	Turn on all devices connected to the unit's output jacks.

## Video

Problem	Cause	Remedy
<b>No video.</b>	Another input source is selected on the unit.	Select an appropriate input source with the input selection keys.
	Another input source is selected on the TV.	Switch the TV input to display the video from the unit.
	The video signal output from the unit is not supported by the TV.	Check the video output setting of the playback device. For information about video signals supported by the TV, refer to the instruction manuals for the TV.
	The cable connecting the unit and TV (or playback device) is defective.	If there is no problem with the connection, replace with another cable.
<b>No video from the playback device (connected to the unit with HDMI).</b>	The input video signal (resolution) is not supported by the unit.	To check the information about the current video signal (resolution), use "Signal Info" in the "Option" menu (p.66). For information about video signals supported by the unit, see "HDMI signal compatibility" (p.102).
	The TV does not support HDCP (High-bandwidth Digital Content Protection).	Refer to the instruction manuals for the TV and check the TV's specifications.
	The number of devices connected to the HDMI OUT jack is over the limit.	Disconnect some of the HDMI devices.
<b>The menu of the unit is not displayed on the TV.</b>	The TV is not connected to the unit via HDMI.	You can display the menu of the unit on the TV only when they are connected with an HDMI cable. If necessary, use an HDMI cable to connect them (p.18 to 21).
	Another input source is selected on the TV.	Switch the TV input to display the video from the unit (HDMI OUT jack).

## FM/AM radio

Problem	Cause	Remedy
<b>FM radio reception is weak or noisy.</b>	There is multi-path interference.	Adjust the FM antenna height or orientation, or place it in a different location.
	Your area is too far from the FM station transmitter.	Press MODE to select monaural FM radio reception (p.43). Use an outdoor FM antenna. We recommend using a sensitive multi-element antenna.
<b>AM radio reception is weak or noisy.</b>	The noises may be caused by fluorescent lamps, motors, thermostats, or other electrical equipment.	It is difficult to completely eliminate noise. It may be reduced by using an outdoor AM antenna.
<b>Radio stations cannot be selected automatically.</b>	Your area is too far from the FM station transmitter.	Select the station manually (p.43). Use an outdoor antenna. We recommend using a sensitive multi-element antenna.
	The AM radio signal is weak.	Adjust the AM antenna orientation. Select the station manually (p.43).
		Use an outdoor AM antenna. Connect it to the ANTENNA (AM) jack together with the supplied AM antenna.
<b>AM radio stations cannot be registered as presets.</b>	Auto Preset has been used.	Auto Preset is for registering FM radio stations only. Register AM radio stations manually (p.44).

## USB and network

Problem	Cause	Remedy
<b>The unit does not detect the USB device.</b>	The USB device is not connected to the USB jack securely.	Turn off the unit, reconnect your USB device, and turn the unit on again.
	The file system of the USB device is not FAT16 or FAT32.	Use a USB device with FAT16 or FAT32 format.
<b>Folders and files in the USB device cannot be viewed.</b>	The data in the USB device is protected by the encryption.	Use a USB device without an encryption function.
<b>The network feature does not function.</b>	The network parameters (IP address) have not been obtained properly.	Enable the DHCP server function on your router and set "DHCP" in the "Setup" menu to "On" on the unit (p.80). If you want to configure the network parameters manually, check that you are using an IP address which is not used by other network devices in your network (p.80).
	The media sharing setting is not correct.	Configure the sharing setting and select the unit as a device to which music contents are shared (p.54).
<b>The unit does not detect the PC.</b>	Some security software installed on your PC is blocking the access of the unit to your PC.	Check the settings of security software installed on your PC.
	The unit and PC are not in the same network.	Check the network connections and your router settings, and then connect the unit and the PC to the same network.
	The MAC address filter is enabled on the unit.	In "MAC Address Filter" in the "Setup" menu, disable the MAC address filter or specify the MAC address of your PC to allow it to access to the unit (p.81).
<b>The files in the PC cannot be viewed or played back.</b>	The files are not supported by the unit or the media server.	Use the file format supported by both the unit and the media server. For information about the file formats supported by the unit, see "Playing back music stored on media servers (PCs/NAS)" (p.54).
<b>The Internet radio cannot be played.</b>	The selected Internet radio station is currently not available.	There may be a network problem at the radio station, or the service may have been stopped. Try the station later or select another station.
	The selected Internet radio station is currently broadcasting silence.	Some Internet radio stations broadcast silence at certain of times of the day. Try the station later or select another station.
	Access to the network is restricted by the firewall settings of your network devices (such as the router).	Check the firewall settings of your network devices. The Internet radio can be played only when it passes through the port designated by each radio station. The port number varies depending on the radio station.
<b>The application for smartphone/tablet "AV Controller" does not detect the unit.</b>	The MAC address filter is enabled on the unit.	In "MAC Address Filter" in the "Setup" menu, disable the MAC address filter or specify the MAC address of your smartphone/tablet to allow it to access to the unit (p.81).
	The unit and smartphone/tablet are not in the same network.	Check the network connections and your router settings, and then connect the unit and smartphone/tablet to the same network.

## Error indications on the front display

Message	Cause	Remedy
<b>Access denied</b>	Access to the PC is denied.	Configure the sharing settings and select the unit as a device to which music contents are shared (p.54).
<b>Access error</b>	The unit cannot access the USB device.	Turn off the unit and reconnect your USB device. If the problem persists, try another USB device.
	The unit cannot access the iPod.	Turn off the iPod and turn it on again.
	There is a problem with the signal path from the network to the unit.	Make sure your router and modem are turned on. Check the connection between the unit and your router (or hub) (p.28).
<b>Check SP Wires</b>	The speaker cables short circuit.	Twist the bare wires of the cables firmly and connect to the unit and speakers properly.
<b>Connect error</b>	The unit has detected the iPod, but cannot access it.	Turn off the iPod and then turn it on again.
<b>Internal Error</b>	An internal error has occurred.	Contact the nearest authorized Yamaha dealer or service center.
<b>MHL Overloaded</b>	An overcurrent is flowing through the MHL-compatible mobile device.	Turn off the unit and check the connection between the unit and mobile device.
<b>No content</b>	There are no playable files in the selected folder.	Select a folder that contains files supported by the unit.
<b>No device</b>	The unit cannot detect the USB device.	Turn off the unit and reconnect your USB device. If the problem persists, try another USB device.
	The unit cannot detect the iPod.	Turn off the iPod and then turn it on again.
<b>Please wait</b>	The unit is preparing for connecting to the network.	Wait until the message disappears. If the message stays more than 3 minutes, turn off the unit and turn it on again.
<b>RemID Mismatch</b>	The remote control IDs of the unit and the remote control are not identical.	Change the remote control ID of the unit or the remote control (p.83).
<b>Unable to play</b>	The unit cannot play back the songs stored on the iPod for some reason.	Check the song data. If it cannot be played on the iPod itself, the song data or storage area may be defective.
	The unit cannot play back the songs stored on the PC for some reason.	Check if the format of files you are trying to play is supported by the unit. For information about the formats supported by the unit, see "Playing back music stored on media servers (PCs/NAS)" (p.54). If the unit supports the file format, but still cannot play back any files, the network may be overloaded with heavy traffic.
<b>Unknown iPod</b>	The connected iPod is not supported by the unit.	Use an iPod supported by the unit (p.47).
<b>USB Overloaded</b>	An overcurrent is flowing through the USB device.	Turn off the unit and reconnect your USB device. If the problem persists, try another USB device.



## Audio information

### ■ Audio decoding format

#### Dolby Digital

Dolby Digital is a compressed digital audio format developed by Dolby Laboratories, Inc. that supports 5.1-channel audio. This technology is used for audio on most DVD discs.

#### Dolby Digital EX

Dolby Digital EX creates total 6.1-channel audio from 5.1-channel sources that are recorded with Dolby Digital Surround EX. This decoder adds a surround back sound to the original 5.1-channel sound.

#### Dolby Digital Plus

Dolby Digital Plus is a compressed digital audio format developed by Dolby Laboratories, Inc. that supports 7.1-channel audio. Dolby Digital Plus remains fully compatible with the existing multichannel audio systems that support Dolby Digital. This technology is used for audio on BD (Blu-ray discs).

#### Dolby Pro Logic II

Dolby Pro Logic II enables 5-channel playback from 2-channel sources. There are three modes available: "Music mode" for music sources, "Movie mode" for movie sources, and "Game mode" for game sources.

#### Dolby Pro Logic IIx

Dolby Pro Logic IIx enables 7-channel playback from 2-channel or multichannel sources. There are three modes available: "Music mode" for music sources, "Movie mode" for movie sources and "Game mode" for game sources (for 2-channel sources only).

#### Dolby TrueHD

Dolby TrueHD is an advanced lossless audio format developed by Dolby Laboratories, Inc. to offer a high-definition home theater experience with the quality of the studio master. Dolby TrueHD can carry up to eight channels of 96 kHz/24-bit audio (up to six channels of 192 kHz/24-bit audio) simultaneously. This technology is used for audio on BD (Blu-ray discs).

#### DTS 96/24

DTS 96/24 is a compressed digital audio format that supports 5.1-channel and 96 kHz/24-bit audio. This format remains fully compatible with the existing multichannel audio systems that support DTS Digital Surround. This technology is used for music DVDs, etc.

#### DTS Digital Surround

DTS Digital Surround is a compressed digital audio format developed by DTS, Inc. that supports 5.1-channel audio. This technology is used for audio on most DVD discs.

#### DTS-ES

DTS-ES creates total 6.1-channel audio from 5.1-channel sources that are recorded with DTS-ES. This decoder adds a surround back sound to the original 5.1-channel sound. In the DTS-ES Matrix 6.1 format, a surround back sound is recorded in the surround channels, and in the DTS-ES Discrete 6.1 format, a discrete surround back channel is recorded.

#### DTS Express

DTS Express is a compressed digital audio format that supports 5.1-channel audio and allows a higher compression rate than the DTS Digital Surround format developed by DTS, Inc. This technology is developed for audio streaming services on the Internet and secondary audio on BD (Blu-ray discs).

#### DTS-HD High Resolution Audio

DTS-HD High Resolution Audio is a compressed digital audio format developed by DTS, Inc. that supports 7.1-channel and 96 kHz/24-bit audio. DTS-HD High Resolution Audio remains fully compatible with the existing multichannel audio systems that support DTS Digital Surround. This technology is used for audio on BD (Blu-ray discs).

#### DTS-HD Master Audio

DTS-HD Master Audio is an advanced lossless audio format developed to offer a high-definition home theater experience with the quality of the studio master by DTS, Inc. DTS-HD Master Audio can carry up to eight channels of 96 kHz/24-bit audio (up to six channels of 192 kHz/24-bit audio) simultaneously. This technology is used for audio on BD (Blu-ray discs).

#### DTS Neo:6

DTS Neo:6 enables 6-channel playback from 2-channel sources. There are two modes available: "Music mode" for music sources and "Cinema mode" for movie sources. This technology provides discrete full-bandwidth matrix channels of surround sound.

#### DSD (Direct Stream Digital)

DSD (Direct Stream Digital) technology stores audio signals on digital storage media, such as SACD (Super Audio CDs). The signals are stored at a high-frequency sampling rate of 2.8224 MHz. The highest frequency response is equal to or higher than 100 kHz, with a dynamic range of 120 dB. This technology offers better audio quality than that used for CDs.

#### FLAC

FLAC is a file format for lossless audio data compression. FLAC is inferior to lossy compressed audio formats in compression rate but provides higher audio quality.

#### MP3

One of the compressed digital audio format used by MPEG. With psychoacoustic technologies, this compression method achieves a high compression rate. Reportedly, it is capable of compressing data quantity by about 1/10 maintaining a certain level of audio quality.

#### MPEG-4 AAC

An MPEG-4 audio standard. It is used for mobile telephones, portable audio players, and audio streaming services on Internet because it allows a high compression rate of data while maintaining better audio quality than MP3.

#### PCM (Pulse Code Modulation)

PCM is a signal format under which an analog audio signal is digitized, recorded, and transmitted. This technology is the basis of all other audio format. This technology is used as a lossless audio format called Linear PCM for audio on a variety of media, including CDs and BD (Blu-ray discs).

### Sampling frequency/Quantization bit

Sampling frequency and quantization bits indicate the quantity of information when an analog audio signal is digitized. These values are noted as in the following example: "48 kHz/24-bit".

- Sampling frequency  
Sampling frequency (the number of times the signal is sampled per second) is called the sampling rate. When the sampling frequency is higher, the range of frequencies that can be played back are wider.
- Quantization bit  
The number of quantization bits indicate the degree of accuracy when converting the sound level into a numeric value. When the number of quantized bits is higher, the expression of the sound level is more accurate.

### WAV

Windows standard audio file format, which defines the method of recording the digital data obtained by converting audio signals. By default, the PCM method (no compression) is used, but you can also use other compression methods.

### WMA (Windows Media Audio)

One of the compressed digital audio formats developed by Microsoft Corporation. With psychoacoustic technologies, this compression method achieves a high compression rate. Reportedly, it is capable of compressing data quantity by about 1/20 maintaining a certain level of audio quality.

## Others

### Bi-amplification connection (Bi-amp)

A bi-amplification connection uses two amplifiers for a speaker. When you use the bi-amplification connection, the unit drives the tweeter and woofer in a speaker with the discrete amplifiers. As a consequence, the tweeter and woofer provide clear audio signal without the interference.

### LFE (Low Frequency Effects) 0.1 channel

This channel reproduces low-frequency bass signals and has a frequency range from 20 Hz to 120 Hz. This channel is added to the channels for all bands with Dolby Digital or DTS to enhance low frequency audio effects. This channel is labeled 0.1 because it is limited to only low frequency audio.

### Lip sync

Video output sometimes lags behind audio output due to the complexity of signal processing caused by an increase in video signal capacity. Lip sync is a technique for automatically correcting the timing lag between audio and video output.

## HDMI and video information

---

### Component video signal

With the component video signal system, the video signal is separated into the Y signal for luminance and the Pb and Pr signals for chrominance. Color can be reproduced more faithfully with this system because each of these signals is independent.

### Composite video signal

With the composite video signal system, color, brightness, and synchronization data signals are combined and transmitted with a single cable.

### Deep Color

Deep Color is a technology that HDMI specification supports. Deep Color increases the number of available colors within the boundaries defined by the RGB or YCbCr color space. Conventional color systems process the color using 8 bits. Deep Color processes the color with 10, 12, or 16 bits. This technology allows HDTVs and other displays to increase from millions of colors to billions of colors and eliminate on-screen color banding for smooth tonal transitions and subtle gradations between colors.

### HDMI

HDMI (High-Definition Multimedia Interface) is the world-wide standard interface for digital audio/video signal transmission. This interface transmits both digital audio and digital video signals using a single cable without any loss. HDMI complies with HDCP (High-bandwidth Digital Content Protection) and provides a secure audio/video interface. For further information on HDMI, visit the HDMI website at "<http://www.hdmi.org/>".

### MHL

MHL (Mobile High-definition Link) is the interface standard for high-speed digital video signal transmission that is developed for mobile devices. This interface transmits both digital audio and digital video signals from mobile devices (such as smartphones) using a single cable with any loss. As with HDMI, MHL complies with HDCP (High-bandwidth Digital Content Protection).

### x.v.Color

"x.v.Color" is a technology that the HDMI specification supports. It is a more extensive color space than sRGB and allows the expression of colors that were not hitherto possible. While remaining compatible with the color gamut of sRGB standards, "x.v.Color" expands the color space, and thus can produce more vivid, natural images.

# Yamaha technologies

---

## **CINEMA DSP (Digital Sound Field Processor)**

Since the Dolby Surround and DTS systems were originally designed for use in movie theaters, their effect is best experienced in a theater that has many speakers designed for acoustic effects. Since home conditions (such as room size, wall material, and number of speakers) can differ so widely, it is inevitable that there are differences in the sound that you hear. Based on a wealth of actually measured data, CINEMA DSP, Yamaha's original DSP technology provides the audiovisual experience of a movie theater in your own home.

## **CINEMA DSP 3D**

The actually measured sound field data contain the information of the height of the sound images. CINEMA DSP 3D mode achieves the reproduction of the accurate height of the sound images so that it creates the accurate and intensive 3D sound fields in a listening room.

## **Compressed Music Enhancer**

The Compressed Music Enhancer feature compensates for missing harmonics in compression music formats (such as MP3). As a result, this technology provides improved performance for the overall sound system.

## **SILENT CINEMA**

Yamaha has developed a natural, realistic sound effect DSP algorithm for headphones. Parameters for headphones have been set for each sound program, so that accurate representations of all the sound programs can be enjoyed on headphones.

## **Virtual CINEMA DSP**

Virtual CINEMA DSP allows the system to virtually reproduce the sound field of the surround speakers with front left and right speakers. Even if the surround speakers are not connected, the unit creates the realistic sound field in a listening room.

## **Virtual Presence Speaker (VPS)**

Virtual Presence Speaker allows the system to virtually reproduce the height of the 3D sound field without front presence speakers. Even if the front presence speakers are not connected, the unit creates the 3D sound field in your room.

## Video signal flow

Video signals input from a video device to the unit are output to a TV as shown below.

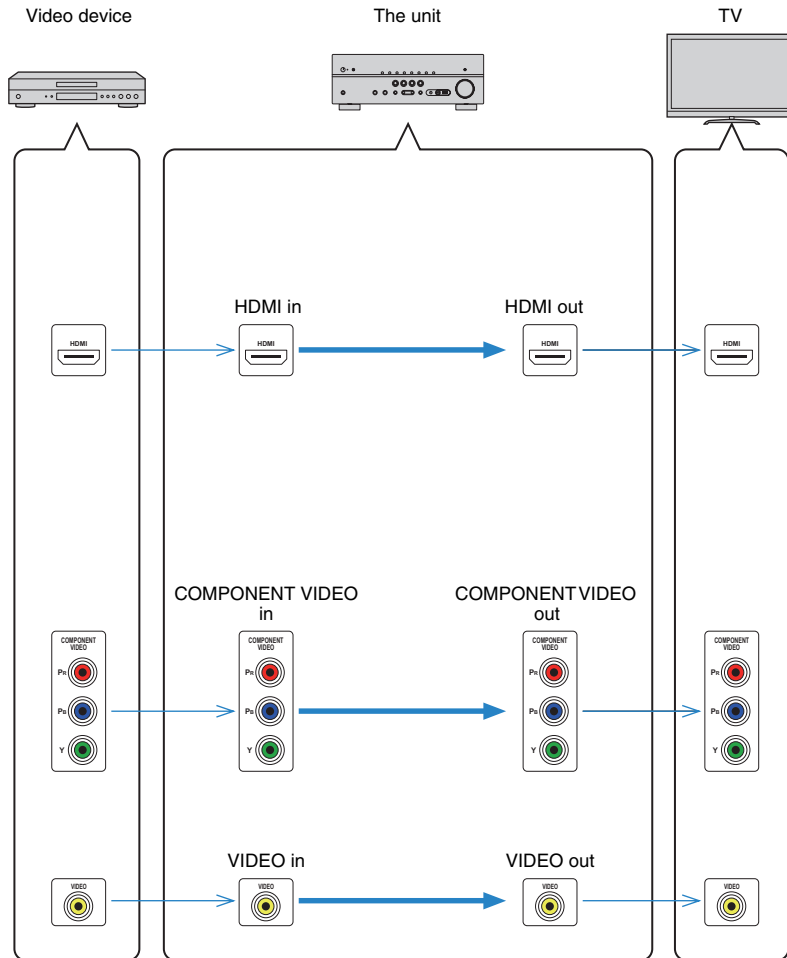

## Information on HDMI

### HDMI Control

HDMI Control allows you to operate external devices via HDMI. If you connect a TV that supports HDMI Control to the unit with an HDMI cable, you can control the unit (such as power and volume) with TV remote control operations. You can also control playback devices (such as HDMI Control-compatible BD/DVD players) connected to the unit with an HDMI cable.

For details on connections, see “Connecting a TV” (p.18) and “Connecting video devices (such as BD/DVD players)” (p.23).

#### Operations available from the TV's remote control

- Standby synchronization
- Volume control including mute
- Switching to input audio from the TV when the TV input is switched to its built-in tuner
- Switching to input video/audio from the selected playback device
- Switching between audio output devices (the unit or TV speaker)

#### (Example)

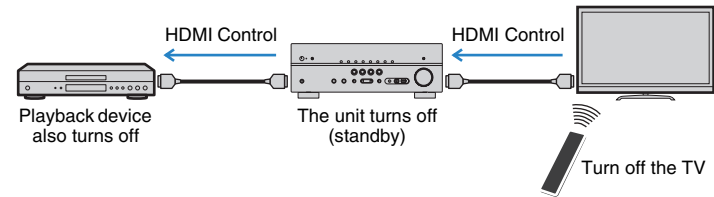

#### Operations available from the unit's remote control

- Starting playback on the playback device and turning on the TV with a scene selection (p.36)
- Switching the TV input to display the “Setup” menu (when SETUP is pressed)
- Controlling the playback device (playback and menu operations) without registering remote control codes (p.86)

(Example)

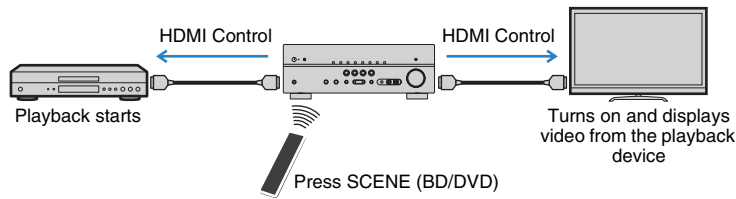

To use HDMI Control, you need to perform the following HDMI Control link setup after connecting the TV and playback devices.



- This setup is required every time you add a new HDMI Control-compatible device to your system.

- 1 Turn on the unit, TV, and playback devices.**
- 2 Enable HDMI Control on the unit, TV, and playback devices (such as HDMI Control-compatible BD/DVD players).**

To enable HDMI Control on the unit, set “HDMI Control” (p.74) in the “Setup” menu to “On” and configure the related items (“TV Audio Input”, “Standby Sync”, “ARC”, and “SCENE”).
- 3 Turn off the main power of the TV and then turn off the unit and playback devices.**
- 4 Turn on the unit and playback devices and then turn on the TV.**
- 5 Switch the TV input to display the video from the unit.**
- 6 Check the followings.**

On the unit: The input to which the playback device is connected is selected.  
If not, select the input source manually.

On the TV: The video from the playback device is displayed.

- 7 Check that the unit is properly synchronized with the TV by turning off the TV or adjusting the TV volume with the TV remote control.**



- If HDMI Control does not work properly, try unplugging the TV in Step 2 and plugging in the TV again in Step 3. It may solve the problem. Also, HDMI Control may not work if the number of connected devices exceeds the limit. In this case, disable HDMI Control on the devices not in use.
- If the unit is not synchronized to the TV's power operations, check the priority of the audio output setting on the TV.
- We recommend using TV and playback devices from the same manufacturer so that HDMI Control works more effectively.

## HDMI signal compatibility

### Audio signals

Audio signal type	Audio signal format	Compatible media (example)
2ch Linear PCM	2ch, 32 to 192 kHz, 16/20/24 bit	CD, DVD-Video, DVD-Audio
Multichannel Linear PCM	8ch, 32 to 192 kHz, 16/20/24 bit	DVD-Audio, BD (Blu-ray disc), HD DVD
DSD	2 to 5.1ch, 2.8224 MHz, 1 bit	SACD
Bitstream	Dolby Digital, DTS	DVD-Video
Bitstream (High definition audio)	Dolby TrueHD, Dolby Digital Plus, DTS-HD Master Audio, DTS-HD High Resolution Audio, DTS Express	BD (Blu-ray disc), HD DVD

### Video signals

The unit is compatible with the video signals of the following resolutions:

- VGA
- 480i/60 Hz
- 576i/50 Hz
- 480p/60 Hz
- 576p/50 Hz
- 720p/60 Hz, 50 Hz
- 1080i/60 Hz, 50 Hz
- 1080p/60 Hz, 50 Hz, 30 Hz, 25 Hz, 24 Hz
- 4K/30 Hz, 25 Hz, 24 Hz



- When CPPM copy-protected DVD-Audio is played back, video/audio signals may not be output, depending on the type of the DVD player.
- The unit is not compatible with HDCP-incompatible HDMI or DVI devices. For details, refer to the instruction manual for each device.
- To decode audio bitstream signals on the unit, set the input source device appropriately so that the device outputs the bitstream audio signals directly (does not decode the bitstream signals on the playback device). For details, refer to the instruction manual for the playback device.

## Reference diagram (rear panel)

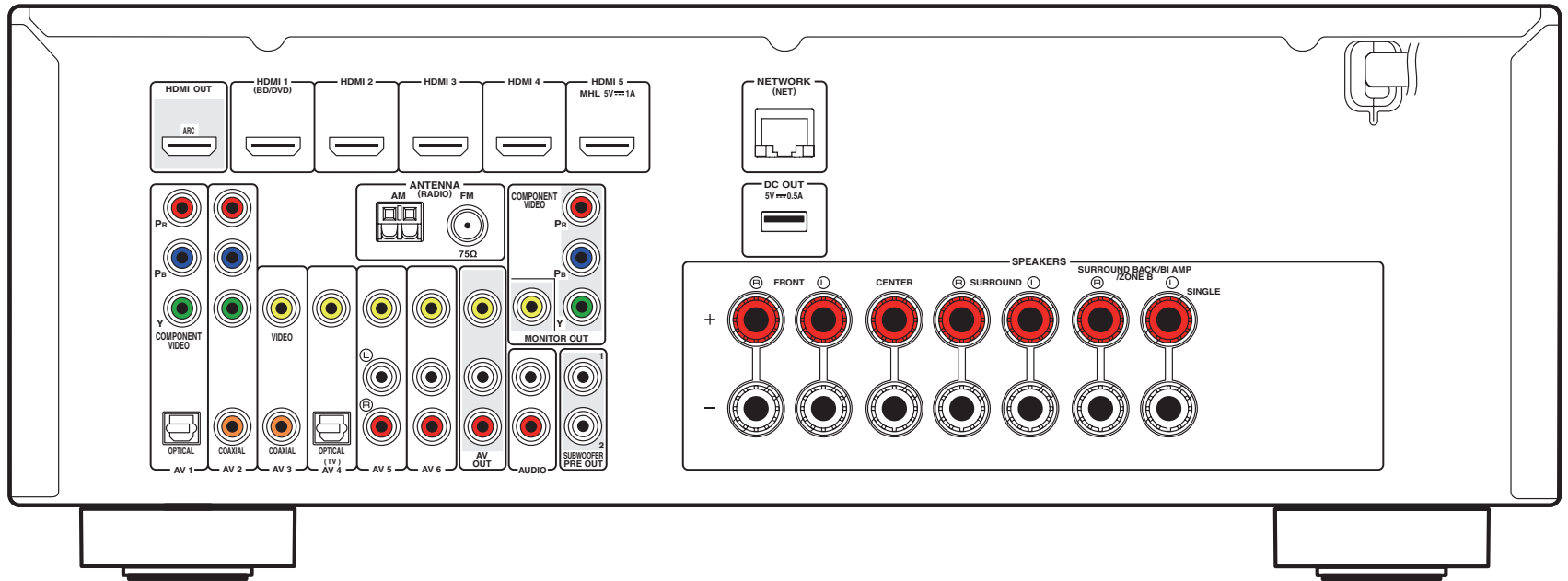

(RX-V575 U.S.A. model)



- The area around the video/audio output jacks is marked in white on the actual product to prevent improper connections.

## Trademarks



Manufactured under license from Dolby Laboratories. Dolby, Pro Logic, Surround EX and the double-D symbol are trademarks of Dolby Laboratories.



(For RX-V475)

Manufactured under license under U.S. Patent Nos: 5,956,674; 5,974,380; 6,226,616; 6,487,535; 7,212,872; 7,333,929; 7,392,195; 7,272,567 & other U.S. and worldwide patents issued & pending. DTS-HD, the Symbol, & DTS-HD and the Symbol together are registered trademarks of DTS, Inc.

Product includes software. © DTS, Inc. All Rights Reserved.



(For RX-V575)

Manufactured under license under U.S. Patent Nos: 5,956,674; 5,974,380; 6,226,616; 6,487,535; 7,212,872; 7,333,929; 7,392,195; 7,272,567 & other U.S. and worldwide patents issued & pending. DTS-HD, the Symbol, & DTS-HD and the Symbol together are registered trademarks & DTS-HD Master Audio is a trademark of DTS, Inc.

Product includes software. © DTS, Inc. All Rights Reserved.



"Made for iPod," "Made for iPhone," and "Made for iPad" mean that an electronic accessory has been designed to connect specifically to iPod, iPhone, or iPad, respectively, and has been certified by the developer to meet Apple performance standards.

Apple is not responsible for the operation of this device or its compliance with safety and regulatory standards.

Please note that the use of this accessory with iPod, iPhone, or iPad may affect wireless performance.

AirPlay, the AirPlay logo, iPad, iPhone, iPod, iPod nano, and iPod touch are trademarks of Apple Inc., registered in the U.S. and other countries.



**Fraunhofer** Institut  
Integrierte Schaltungen

MPEG Layer-3 audio coding technology licensed from Fraunhofer IIS and Thomson.



This receiver supports network connections.



HDMI, the HDMI Logo, and High-Definition Multimedia Interface are trademarks or registered trademarks of HDMI Licensing LLC in the United States and other countries.



MHL and the MHL logo are a trademark, registered trademark or service mark of MHL, LLC in the United States and/or other countries.

**x.v.Color™**

"x.v.Color" is a trademark of Sony Corporation.

**SILENT™  
CINEMA**

"SILENT CINEMA" is a trademark of Yamaha Corporation.



DLNA™ and DLNA CERTIFIED™ are trademarks or registered trademarks of Digital Living Network Alliance. All rights reserved. Unauthorized use is strictly prohibited.

**Windows™**

Windows is a registered trademark of Microsoft Corporation in the United States and other countries.

Internet Explorer, Windows Media Audio and Windows Media Player are either registered trademarks or trademarks of Microsoft Corporation in the United States and/or other countries.

**Android™**

Android is a trademark of Google Inc.



# Specifications

## Input jacks

- Analog Audio
  - Audio x 4 (AV 5–6, AUDIO, V-AUX [Mini Jack])
- Digital Audio (Supported frequencies: 32 kHz to 96 kHz)
  - Optical x 2 (AV 1, AV 4)
  - Coaxial x 2 (AV 2–3)
- Video
  - Composite x 5 (AV 3–6, V-AUX)
  - Component x 2 (AV 1–2)
- HDMI Input
  - HDMI x 5 (HDMI 1–5\*)
  - \* HDMI 5: MHL input compatible
- Other jacks
  - USB x 1 (USB2.0)
  - NETWORK x 1 (100Base-TX/10Base-T)

## Output jacks

- Analog Audio [RX-V575]
  - Speaker Out x 7 (FRONT L/R, CENTER, SURROUND L/R, SURROUND BACK L/R\*)
  - \* Note: assignment is possible. [SURROUND BACK, BI-AMP (FRONT L/R), ZONE B]
  - Subwoofer Out x 2 (SUBWOOFER 1–2, mono)
  - AV OUT x 1
  - Headphone x 1
- [RX-V475]
  - Speaker Out x 5 (FRONT L/R, CENTER, SURROUND L/R)
  - Subwoofer Out x 1
  - AV OUT x 1
  - Headphone x 1

- Video
  - MONITOR OUT
  - Component x 1
  - Composite x 1
- AV OUT
  - Composite x 1
- HDMI Output
  - HDMI OUT x 1

## Other jacks

- YPAO MIC x 1
- DC OUT x 1

## HDMI

- HDMI features: Deep Color, "x.v.Color," Auto Lip Sync, ARC (Audio Return Channel), 3D, 4K
- Video Format (Repeater Mode)
  - VGA
  - 480i/60 Hz
  - 576i/50 Hz
  - 480p/60 Hz
  - 576p/50 Hz
  - 720p/60 Hz, 50 Hz
  - 1080i/60 Hz, 50 Hz
  - 1080p/60 Hz, 50 Hz, 30 Hz, 25 Hz, 24 Hz
  - 4K/30 Hz, 25 Hz, 24 Hz
- Audio Format
  - Dolby TrueHD
  - Dolby Digital Plus
  - Dolby Digital
  - DTS-HD Master Audio
  - DTS-HD High Resolution Audio
  - DTS Express
  - DTS
  - DSD 6-ch
  - PCM 2-ch to 8-ch (Max. 192 kHz/24-bit)

- Content Protection: HDCP compatible
- Link Function: CEC supported

## MHL

- Video Format (Repeater Mode)
  - VGA
  - 480i/60 Hz
  - 576i/50 Hz
  - 480p/60 Hz
  - 576p/50 Hz
  - 720p/60 Hz, 50 Hz
  - 1080i/60 Hz, 50 Hz
  - 1080p/30 Hz, 25 Hz, 24 Hz
- Audio Format
  - PCM 2-ch to 8-ch (Max. 192 kHz/24-bit)
- Current Supply Capacity: 1.0 A

## TUNER

- Analog Tuner [U.K. and Europe models]
  - FM/AM with Radio Data System x 1 (TUNER)
- [Other models]
  - FM/AM x 1 (TUNER)

## USB

- Capable of iPod, Mass Storage Class USB Memory
- Current Supply Capacity: 2.1 A

## Network

- PC Client Function
- Compatible with DLNA ver. 1.5
- AirPlay supported
- Internet Radio

## Compatible Decoding Formats

- Decoding Format
  - Dolby TrueHD, Dolby Digital Plus
  - Dolby Digital EX
  - Dolby Digital
  - DTS-HD Master Audio, DTS-HD High Resolution Audio, DTS Express
  - DTS, DTS 96/24, DTS-ES Matrix 6.1, DTS-ES Discrete 6.1
  - DTS Digital Surround
- Post Decoding Format [RX-V575]
  - Dolby Pro Logic
  - Dolby Pro Logic II Music, Dolby Pro Logic II Movie, Dolby Pro Logic II Game
  - Dolby Pro Logic IIx Music, Dolby Pro Logic IIx Movie, Dolby Pro Logic IIx Game
  - DTS Neo:6 Music, DTS Neo:6 Cinema [RX-V475]
  - Dolby Pro Logic
  - Dolby Pro Logic II Music, Dolby Pro Logic II Movie, Dolby Pro Logic II Game
  - DTS Neo:6 Music, DTS Neo:6 Cinema

## Audio Section

- Rated Output Power (2-channel driven)
  - [U.S.A. and Canada models] (20 Hz to 20 kHz, 0.09% THD, 8 Ω)
  - [Other models] (20 Hz to 20 kHz, 0.09% THD, 6 Ω)
  - Front L/R ..... 80 W+80 W
  - [U.S.A. and Canada models] (1 kHz, 0.9% THD, 8 Ω)
  - Front L/R ..... 95 W+95 W
  - Center ..... 95 W
  - Surround L/R ..... 95 W+95 W
  - Surround Back L/R [RX-V575] ..... 95 W+95 W

- Rated Output Power (1-channel driven)
  - [U.S.A. and Canada models] (1 kHz, 0.9% THD, 8 Ω)
  - [Other models] (1 kHz, 0.9% THD, 6 Ω)
  - Front L/R ..... 115 W/ch
  - Center ..... 115 W/ch
  - Surround L/R ..... 115 W/ch
  - Surround Back L/R [RX-V575] ..... 115 W/ch
- Maximum Effective Output Power (JEITA, 1 kHz, 10% THD, 6 Ω)
  - [China, Korea, Asia and General models]
  - Front L/R ..... 135 W/ch
  - Center ..... 135 W/ch
  - Surround L/R ..... 135 W/ch
  - Surround Back L/R [RX-V575] ..... 135 W/ch
- Dynamic Power (IHF)
  - [U.S.A. and Canada models]
  - RX-V475:
    - Front L/R (8/6/4/2 Ω) ..... 110/130/160/180 W
  - RX-V575:
    - Front L/R (8/6/4/2 Ω) ..... 120/140/170/190 W
  - [Other models]
  - RX-V475:
    - Front L/R (6/4/2 Ω) ..... 110/130/160 W
  - RX-V575:
    - Front L/R (6/4/2 Ω) ..... 120/140/170 W
- Dynamic Headroom [U.S.A. and Canada models]
  - 8 Ω ..... 0.2 dB
- Damping Factor
  - Front L/R, 20 Hz to 20 kHz, 8 Ω ..... 120 or more
- Input Sensitivity / Input Impedance
  - AV 5 etc. (1 kHz, 100 W/8 Ω) ..... 200 mV/47 kΩ
- Maximum Input Signal
  - AV 5 etc. (1 kHz, 0.5% THD, Effect On) ..... 2.3 V
- Output Level / Output Impedance
  - AV OUT ..... 200 mV/1.2 kΩ
  - SUBWOOFER ..... 1 V/1.2 kΩ
- Headphone Jack Rated Output / Impedance
  - AV 5 etc. (1 kHz, 50 mV, 8 Ω) ..... 100 mV/470 Ω

- Frequency Response
  - AV 5 etc. to Front (10 Hz to 100 kHz) ..... +0/-3 dB
- Signal to Noise Ratio (IHF-A Network)
  - AV 5 etc. (Input Shorted 250 mV, Speaker Out) ..... 100 dB or more
- Residual Noise (IHF-A Network)
  - Front L/R (Speaker Out) ..... 150 μV or less
- Channel Separation
  - AV 5 etc. (Input 5.1 kΩ Shorted, 1 kHz/10 kHz) ..... 60 dB/45 dB or more
- Volume Control
  - Range ..... MUTE, -80 dB to +16.5 dB
  - Step ..... 0.5 dB
- Tone Control Characteristics
  - Bass Boost/Cut ..... ±6 dB/0.5 dB Step at 50 Hz
  - Bass Turnover ..... 350 Hz
  - Treble Boost/Cut ..... ±6 dB/0.5 dB Step at 20 kHz
  - Treble Turnover ..... 3.5 kHz
- Filter Characteristics
  - (f<sub>c</sub>=40/60/80/90/100/110/120/160/200 Hz)
  - H.P.F. (Front, Center, Surround) ..... 12 dB/oct.
  - H.P.F. (Surround Back [RX-V575]) ..... 12 dB/oct.
  - L.P.F. (Subwoofer) ..... 24 dB/oct.

## Video Section

- Video Signal Type  
[U.S.A., Canada, Korea and General models] ..... NTSC  
[Other models]..... PAL
- Video Signal Level  
Composite ..... 1 Vp-p/75 Ω  
Component  
Y..... 1 Vp-p/75 Ω  
Pb/Pr..... 0.7 Vp-p/75 Ω
- Video Maximum Input Level ..... 1.5 Vp-p or more
- Video Signal to Noise Ratio .....50 dB or more
- Monitor Out Frequency Response  
Component..... 5 Hz to 60 MHz, -3 dB

## FM Section

- Tuning Range  
[U.S.A. and Canada models] ..... 87.5 to 107.9 MHz  
[Asia and General models]  
.....87.5/87.50 MHz to 108.0/108.00 MHz  
[Other models]..... 87.50 MHz to 108.00 MHz
- 50 dB Quiet Sensitivity (IHF, 1 kHz, 100% MOD.)  
Mono..... 3 μV (20.8 dBf)
- Signal to Noise Ratio (IHF)  
Mono.....71 dB  
Stereo .....69 dB
- Harmonic Distortion (IHF, 1 kHz)  
Mono..... 0.3%  
Stereo ..... 0.5%
- Antenna Input.....75 Ω unbalanced

## AM section

- Tuning Range  
[U.S.A. and Canada models] ..... 530 to 1710 kHz  
[Asia and General models]..... 530/531 kHz to 1710/1611 kHz  
[Other models]..... 531 kHz to 1611 kHz

## General

- Power Supply  
[U.S.A. and Canada models] .....AC 120 V, 60 Hz  
[General model] .....AC110 to 120/220 to 240 V, 50/60 Hz  
[China model].....AC 220 V, 50 Hz  
[Korea model] .....AC 220 V, 60 Hz  
[Australia model] .....AC 240 V, 50 Hz  
[U.K. and Europe models] .....AC 230 V, 50 Hz  
[Asia model] .....AC 220 to 240 V, 50/60 Hz
- Power Consumption  
[U.S.A. and Canada models] ..... 270 W/320 VA  
[Other models] .....280 W
- Standby Power Consumption  
HDMI Control Off, Standby Through Off ..... 0.1 W or less  
HDMI Control On, Standby Through On (No Signals)  
..... 1.0 W (Typical)  
Network Standby On ..... 2.0 W (Typical)
- Dimensions (W x H x D)  
..... 435 x 161 x 315 mm (17-1/8" x 6-3/8" x 12-3/8")  
\* Including legs and protrusions
- Weight  
[RX-V575] .....8.2 kg (18.1 lbs)  
[RX-V475] .....8.1 kg (17.9 lbs)

\* Specifications are subject to change without notice.

# Index

## Symbols

- ★/★★ keys 10
- Envelope icon (✉) 88
- Lock icon (🔒) 79

## Numerics

- 2.1-channel system 14
- 2ch Stereo (sound program) 39
- 3.1-channel system 14
- 4.1-channel system 13
- 4K signal (video signal resolution) 102
- 5.1-channel system 13, 15
- 5ch Stereo (sound program) 39
- 6.1-channel system 13
- 7.1-channel system 13, 15
- 7ch Stereo (sound program) 39

## A

- A.DRC (DSP/Surround, Option menu) 65
- Access denied (error indication) 96
- Access error (error indication) 96
- Action Game (sound program) 38
- Adaptive DRC (DSP/Surround, Option menu) 65
- Adjustment (Lipsync, Setup menu) 76
- ADVANCED SETUP menu 83
- Adventure (sound program) 38
- AirPlay 59
- AM antenna connection 27
- AM radio listening 43
- Amp (Audio Output, Setup menu) 74
- ARC (Audio Return Channel) 18
- ARC (HDMI, Setup menu) 75
- Audio Decoder (front display information) 63
- Audio device connection 26
- Audio file format (PC/NAS) 54
- Audio file format (USB storage device) 51
- Audio In (Option menu) 67
- AUDIO jack 17

- Audio Output (HDMI, Setup menu) 74
- Audio Return Channel (ARC) 18
- Auto Power Standby (ECO, Setup menu) 77
- Auto Preset (FM radio, Option menu) 44
- Automatic speaker setting optimization 31
- Automatic station preset (FM radio) 44
- AutoPowerStdby (ECO, Setup menu) 77
- AV OUT jack 9

## B

- B RATE (Signal Info, Option menu) 66
- Banana plug 16
- Basic playback operation 35
- Bass (Tone Control, Option menu) 65
- BI-AMP (Power Amp Assign, Setup menu) 71
- Bi-amp speaker connection 16
- Bitrate (Signal Info, Option menu) 66
- Bitstream 102

## C

- CAT-5 cable 28
- Cellar Club (sound program) 39
- Center (Speaker, Setup menu) 71
- Center Image (DSP Parameter, Setup menu) 76
- Center Width (DSP Parameter, Setup menu) 76
- Chamber (sound program) 39
- CHAN (Signal Info, Option menu) 66
- Channel (Signal Info, Option menu) 66
- Check SP Wires (error indication) 96
- Check Sur. (YPAO error message) 33
- CINEMA DSP 38
- CINEMA DSP 3D 40
- CINEMA DSP 3D Mode (DSP Parameter, Setup menu) 75
- Clear Preset (FM/AM radio, Option menu) 45
- Clock Time (Radio Data System) 46
- COAXIAL jack 17
- Component video cable 17

- Component video connection (video device) 24
- COMPONENT VIDEO jack 17
- Composite video connection (video device) 24
- Compressed Music Enhancer 42
- Configuration (HDMI, Setup menu) 74
- Configuration (Speaker, Setup menu) 71
- Connect error (error indication) 96
- Crossover (Speaker, Setup menu) 72
- Crossover frequency setting 72
- Crossover frequency setting (subwoofer) 31

## D

- DC OUT (Function, Setup menu) 79
- DC OUT jack 9
- Decoder Off (front display information) 63
- Default Gateway (Information, Setup menu) 80
- Default Gateway (IP Address, Setup menu) 80
- DHCP (IP Address, Setup menu) 80
- Digital coaxial cable 17
- Digital Media Controller (DMC) 81
- Digital optical cable 17
- Dimension (DSP Parameter, Setup menu) 76
- Dimmer (Function, Setup menu) 79
- DIRECT (sound mode) 41
- Direct playback 41
- Direct Stream Digital (DSD) 97
- Distance (Speaker, Setup menu) 73
- DLNA 54
- DMC (Digital Media Controller) 81
- DMC Control (Network, Setup menu) 81
- DNS Server (Information, Setup menu) 80
- DNS Server (IP Address, Setup menu) 80
- Dolby Digital EX (Extended Surround) 65
- Dolby Pro Logic (surround decoder) 41
- Dolby Pro Logic II Game (surround decoder) 41
- Dolby Pro Logic II Movie (surround decoder) 41
- Dolby Pro Logic II Music (surround decoder) 41
- Dolby Pro Logic IIx Game (surround decoder) 41

Dolby Pro Logic IIx Movie (Extended Surround) 65  
 Dolby Pro Logic IIx Movie (surround decoder) 41  
 Dolby Pro Logic IIx Music (Extended Surround) 65  
 Dolby Pro Logic IIx Music (surround decoder) 41  
 Drama (sound program) 38  
 DSD (Direct Stream Digital) 97  
 DSP Level (DSP/Surround, Option menu) 65  
 DSP Parameter (Sound, Setup menu) 75  
 DSP Program (front display information) 63  
 DSP/Surround (Option menu) 65  
 DTS Neo:6 Cinema (surround decoder) 41  
 DTS Neo:6 Music (surround decoder) 41  
 DTS-ES (Extended Surround) 65  
 Dynamic Range (Volume, Setup menu) 77

**E**

ECO (Setup menu) 77  
 ECO Mode (Setup menu) 78  
 Enhancer (DSP/Surround, Option menu) 66  
 ENHANCER (sound mode) 42  
 EQ Select (Equalizer, Setup menu) 73  
 Equalizer (Speaker, Setup menu) 73  
 Error indication (front display) 96  
 EX/ES (Extended Surround, Option menu) 65  
 EXT D (DSP/Surround, Option menu) 65  
 Extended Surround (DSP/Surround, Option menu) 65  
 External device control (remote control) 85  
 External device operation key (remote control) 10  
 Extra Bass (Speaker, Setup menu) 72

**F**

Filter (MAC Address Filter, Setup menu) 81  
 Firmware update 84  
 Firmware update (network) 84, 88  
 Firmware update (USB) 84  
 Firmware Version (Network Update, Setup menu) 82  
 Firmware version check 84  
 FM antenna connection 27  
 FM radio listening 43  
 FM/AM radio tuning 43  
 FORMAT (Signal Info, Option menu) 66

Format (Signal Info, Option menu) 66  
 Frequency (FM/AM radio) 43  
 Frequency step setting 43, 84  
 Front (Speaker, Setup menu) 71  
 Front display (part names and functions) 8  
 Front display brightness 79  
 Front display information 63  
 Front panel (part names and functions) 7  
 Front panel jack connection 26  
 Function (Setup menu) 78

## G

GEQ (Equalizer, Setup menu) 73

## H

Hall in Munich (sound program) 39  
 Hall in Vienna (sound program) 39  
 HDMI (Setup menu) 74  
 HDMI cable 17  
 HDMI connection (video device) 23  
 HDMI Control (HDMI, Setup menu) 74  
 HDMI jack 17  
 HDMI OUT (TV) (Audio Output, Setup menu) 74  
 HDMI signal compatibility 102  
 Headphones 42  
 High definition audio 102  
 High speed HDMI cable 17

## I

In.Trim (Volume Trim, Option menu) 66  
 Indicator (part names and functions) 8  
 INFO key 7, 10  
 Information (Network, Setup menu) 80  
 Information display (front display) 8  
 Information switching (front display) 63  
 INIT (ADVANCED SETUP menu) 84  
 Initial Volume (Volume, Setup menu) 77  
 Input (front display information) 63  
 Input (Signal Info, Option menu) 66  
 Input Rename (Function, Setup menu) 78  
 Input selection key (remote control) 10

Input Trim (Volume Trim, Option menu) 66  
 Interlock (Option menu) 67  
 Internal Err. (YPAO error message) 33  
 Internal Error (error indication) 96  
 Internet radio listening 57  
 IP Address (Information, Setup menu) 80  
 IP Address (Network, Setup menu) 80  
 iPod charge 47  
 iPod connection 47  
 iPod content playback 48  
 iPod content playback (AirPlay) 59  
 iTunes content playback (AirPlay) 59

## L

Language (Setup menu) 82  
 Level (Speaker, Setup menu) 73  
 Level Error (YPAO warning message) 34  
 LFE (Low Frequency Effects) 98  
 Lipsync 98  
 Lipsync (Option menu) 66  
 Lipsync (Sound, Setup menu) 76  
 Low Frequency Effects (LFE) 98

## M

MAC Address (Information, Setup menu) 80  
 MAC Address (MAC Address Filter, Setup menu) 81  
 MAC Address Filter (Network, Setup menu) 81  
 Manual station preset (FM/AM radio) 44  
 Max Volume (Volume, Setup menu) 77  
 Media sharing setup 54  
 Memory Guard (Function, Setup menu) 79  
 Menu language selection 30  
 Menu operation key (remote control) 10  
 MHL cable 17  
 MHL connection 23  
 MHL jack 17  
 MHL Overloaded (error indication) 96  
 MHL-compatible mobile device 23  
 MODE key 10  
 Monaural reception (FM radio) 43  
 Mono Movie (sound program) 38

MOVIE (sound program category) 38  
 Multiple room playback 61  
 MUSIC (sound program category) 39  
 Music Video (sound program) 39  
 MUTE key 10  
 Muting 35  
**N**  
 NAS (Network Attached Storage) 28  
 NAS connection 28  
 NAS content playback 54  
 Network (Setup menu) 80  
 Network Attached Storage (NAS) 28  
 Network cable 28  
 Network connection 28  
 Network information 80  
 Network Name (Network, Setup menu) 81  
 Network Standby (Network, Setup menu) 81  
 Network Update (Network, Setup menu) 82  
 No content (error indication) 96  
 No device (error indication) 96  
 No Front SP (YPAO error message) 33  
 No MIC (YPAO error message) 33  
 No Signal (YPAO error message) 33  
 No Sur. SP (YPAO error message) 33  
 Noisy (YPAO error message) 33  
 NTSC (TV FORMAT, ADVANCED SETUP menu) 84  
 Numeric key (remote control) 10  
**O**  
 OPTICAL jack 17  
 OPTION key 10  
 Option menu 64  
 Out of Phase (YPAO warning message) 34  
 Output (Signal Info, Option menu) 66  
 Over Distance (YPAO warning message) 34  
**P**  
 PAL (TV FORMAT, ADVANCED SETUP menu) 84  
 Panorama (DSP Parameter, Setup menu) 75  
 PC connection 28

PC content playback 54  
 PEQ (Equalizer, Setup menu) 73  
 Perform Update (Network Update, Setup menu) 82  
 PHONES jack 7  
 Playback device connection 23  
 Playback device operation (remote control) 86  
 Please wait (error indication) 96  
 Power Amp Assign (Speaker, Setup menu) 71  
 Power cable connection 29  
 Power management 77  
 Power Mode (DC OUT, Setup menu) 79  
 Preset station selection (FM/AM radio) 45  
 Program Service (Radio Data System) 46  
 Program Type (Radio Data System) 46

**R**  
 Radio Data System (FM radio) 46  
 Radio Data System information 46  
 Radio Data System tuning 46  
 Radio Text (Radio Data System) 46  
 Rear panel (part names and functions) 9  
 Recording device connection 29  
 RemID Mismatch (error indication) 96  
 Remote control (part names and functions) 10  
 Remote control code registration  
 (playback device) 86  
 Remote control code registration (TV) 85  
 Remote Control Code Search 85, 86  
 Remote control ID setting 83  
 Remote control ID setting (remote control) 83  
 Remote control sensor 7  
 Remote control signal transmitter (remote control) 10  
 REMOTE ID (ADVANCED SETUP menu) 83  
 Rename (input name) 78  
 Rename (network name) 81  
 Repeat (iPod, Option menu) 50  
 Repeat (PC/NAS, Option menu) 56  
 Repeat (USB storage device, Option menu) 53  
 Reset (remote control) 87  
 Roleplaying Game (sound program) 38

Router connection 28  
**S**  
 SAMPL (Signal Info, Option menu) 66  
 Sampling (Signal Info, Option menu) 66  
 SBR → SBL (YPAO error message) 33  
 SCENE (HDMI, Setup menu) 75  
 Scene configuration 36  
 SCENE function 36  
 SCENE link playback 36  
 Sci-Fi (sound program) 38  
 Select (Lipsync, Setup menu) 76  
 SETUP key 10  
 Setup menu 68  
 Shuffle (iPod, Option menu) 50  
 Shuffle (PC/NAS, Option menu) 56  
 Shuffle (USB storage device, Option menu) 53  
 Signal Info (Option menu) 66  
 Signal information 66  
 SILENT CINEMA 42  
 Simple play (iPod) 49  
 SLEEP key 10  
 Sleep timer 10  
 Sound (Setup menu) 75  
 Sound field effect 38  
 Sound mode selection 37  
 Sound program 38  
 SP IMP. (ADVANCED SETUP menu) 83  
 Speaker (Setup menu) 71  
 Speaker cable connection 16  
 Speaker connection 15  
 Speaker impedance 12  
 Speaker impedance setting 14, 83  
 Speaker indicator (front display) 8  
 Speaker placement 12  
 Spectacle (sound program) 38  
 Sports (sound program) 38  
 Standard (sound program) 38  
 Standby indicator (front panel) 7  
 Standby Sync (HDMI, Setup menu) 75

- Standby Through (HDMI, Setup menu) 74
  - Station preset (FM/AM radio) 44
  - Status (Information, Setup menu) 80
  - Stereo mini jack 17
  - Stereo mini-plug cable 17
  - Stereo pin cable (RCA cable) 17
  - Stereo reception (FM radio) 43
  - STP network cable 28
  - STRAIGHT (sound mode) 40
  - Straight decode 40
  - Subnet Mask (Information, Setup menu) 80
  - Subnet Mask (IP Address, Setup menu) 80
  - Subwoofer (Speaker, Setup menu) 71
  - Subwoofer connection 16
  - Subwoofer Phase (Speaker, Setup menu) 72
  - Subwoofer Trim (Volume Trim, Option menu) 66
  - SUR.DECODE (sound mode) 41
  - Surround (Speaker, Setup menu) 72
  - Surround Back (Speaker, Setup menu) 72
  - Surround decoder 41
  - SW.Trim (Volume Trim, Option menu) 66
  - System ID (Network Update, Setup menu) 82
- T**
- Test Tone (Speaker, Setup menu) 73
  - The Bottom Line (sound program) 39
  - The Roxy Theatre (sound program) 39
  - Tone Control (Option menu) 65
  - TONE CONTROL key 7
  - TP (Traffic Program) 46
  - Traffic information (Radio Data System) 46
  - Traffic Program (FM radio, Option menu) 46
  - Treble (Tone Control, Option menu) 65
  - TU (ADVANCED SETUP menu) 84
  - TV Audio Input (HDMI, Setup menu) 74
  - TV connection 18
  - TV connection (ARC-compatible TV) 18
  - TV connection (HDMI Control-compatible TV) 20
  - TV connection (TV with HDMI input jacks) 21
  - TV connection (TV without HDMI input jacks) 22
- TV FORMAT (ADVANCED SETUP menu) 84
  - TV operation (remote control) 85
  - TV operation key (remote control) 10
- U**
- Unable to play (error indication) 96
  - Unknown iPod (error indication) 96
  - UPDATE (ADVANCED SETUP menu) 84
  - USB jack 7
  - USB mass storage class device 51
  - USB Overloaded (error indication) 96
  - USB storage device connection 51
  - USB storage device content playback 51
  - User Cancel (YPAO error message) 33
- V**
- V IN (Signal Info, Option menu) 66
  - V OUT (Signal Info, Option menu) 66
  - VERSION (ADVANCED SETUP menu) 84
  - VIDEO AUX jack 7
  - Video device connection 23
  - VIDEO jack 17
  - Video Out (Option menu) 67
  - Video pin cable 17
  - Video signal flow 100
  - Video signal type setting 84
  - Video/audio input jack combination 25
  - Virtual CINEMA DSP 40
  - Virtual Presence Speaker (VPS) 6
  - Voltage selection 29
  - VOLTAGE SELECTOR 9
  - Volume (Sound, Setup menu) 77
  - Volume Interlock (Option menu) 67
  - Volume Trim (Option menu) 66
  - VPS (Virtual Presence Speaker) 6
  - vTuner ID (Information, Setup menu) 80
- Y**
- Yamaha Parametric room Acoustic Optimizer (YPAO) 31
- YPAO
  - (Yamaha Parametric room Acoustic Optimizer) 31
  - YPAO error message 33
  - YPAO MIC jack 7
  - YPAO microphone 31
  - YPAO warning message 34
- Z**
- ZB.Trim (Volume Trim, Option menu) 62
  - Zone B 61
  - Zone B (Power Amp Assign, Setup menu) 71
  - Zone B operation 62
  - Zone B preparation 61
  - Zone B speaker connection 61
  - Zone B Volume (Volume, Setup menu) 77
  - Zone B volume adjustment 62
  - ZONE indicator (front display) 8
  - ZONE key 10
  - ZoneB Trim (Volume Trim, Option menu) 62

