

YAMAHA

DIGITAL REVERBERATOR

REV-1

REMOTE CONTROL UNIT

RCR-1

OPERATING MANUAL

ABSTRACT

The REV-1 is a professional digital reverberator with 1 input and 2 outputs. Various reverberation effects can be added to original sounds by allowing early reflections and subsequent reverberation to be independently controlled and mixed together. The REV-1 is a highly refined system which offers superb performance and is well suited for use in halls, recording studios, broadcasting, and for sound reinforcement applications.

FEATURES

A Professional Digital Reverberator with Excellent Performance

The REV-1 is a digital reverb unit which meets all requirements for use in halls, recording studios, and broadcasting stations. The frequency response is from 20 Hz to 18 kHz, distortion is below 0.03%, and the dynamic range is 85 dB in reverb mode.

Independent Control of Early Reflections and Subsequent Reverberation

YAMAHA's proprietary large scale integration (LSI) chips for signal processing, and a micro computer, allow subsequent reverberation of high quality, and up to 40 early reflections (L, R each) to be independently controlled and programmed. Also, use of the remote control unit enables user control over elements such as sound directly from the source, early reflections bouncing off surfaces, as well as subsequent reverberation, in which the reflections are multiplied, to be perfectly controlled. Thus, the delicate natural acoustic properties of concert halls can be accurately simulated.

The following can be controlled with the remote control unit:

• Early Reflections

Any one of eight different early reflection modes can be selected. Initial delay can be set up to 600 msec. in steps of 1 msec. Accurate simulation of the natural acoustic properties of virtually any environment is made possible through the free control of settings for: room size (volume of room), the number of early reflections, an acoustic absorption coefficient of walls.

• Subsequent Reverberations

Any one of eight different subsequent reverberation modes can be selected. The delay time between direct sound and subsequent reverberation can be set up to 600 msec. in steps of 1 msec. Reverberation time can be selected from 0.1 sec. up to 99.9 sec. at the mid-low frequency band. Also, reverberation time can be adjusted differently in each of the four frequency bands (high, mid-high, mid-low, and low).

99 Memories Main unit (ROM - 30, RAM - 60), Remote control unit (RAM - 9)

The unit makes available 30 pre-set memories. They include such settings as: "LARGE HALL", "HAND CLAP", "PERCUSSION PLATE", and "CHORUS". In addition, the user can store modifications of these pre-set programs, or his own program, in any of the 69 user-programmable memories.

Numeric Data Entry

The user can enter data easily with the ten numeric buttons on the main unit, a ten-key numeric pad on the remote control unit, and the "UP" and "DOWN" keys and buttons. The data being entered can be monitored on 3-digit, 7-segment LEDs on the main and remote control units, as well as a liquid crystal display (LCD), on the remote control unit.

Input Level with 16 Step LEDs

This assures a precise level setting and a wide dynamic range. On the front panel of the main unit, the input can be monitored, as well as on the remote control unit, with which both input and output can be monitored.

Specialized Remote Control Unit

Use of the remote control unit enables the following three elements to be perfectly controlled: direct sound; early reflections; and subsequent reverberation. By varying the settings for these three elements, the natural acoustic properties of concert halls can be accurately simulated. In addition, the remote control unit is equipped with a lighted 64×240 dot matrix liquid crystal display (LCD). Any one of eight different graphical display modes for such values as reverb waveforms (W/F) or reverb time (R/T) can be chosen to aid in the setting of data. Reverb time has two different displays: Delay 1 and Delay 2; and there are displays for the low and high pass filters.

Computer Connector and Other Extension Terminals

The REV-1 is equipped with a terminal which enables computer control (RS-232C compatible), a terminal for an external word clock, and there is an optional terminal for digital I/O.

19 Inch Standard Rack Mount

TABLE OF CONTENTS

INTRODUCTION (Please read before use)	4	REMOTE CONTROL DISPLAYS	32
SPECIFICATIONS	5	REV-1 UNIT LAYOUT	34
FRONT PANEL CONTROLS	7	RCR-1 DISASSEMBLY	34
REAR PANEL	9	DIAGNOSTICS PROGRAMS.....	35
APPLICATION	10	MAINTENANCE	36
MEMORY LIST	11	KEYS FOR SPECIAL MEMORIES	37
REMOTE CONTROL UNIT	12	APPENDIX	39
BASIC OPERATION			
FRONT PANEL OPERATION	22		
REMOTE CONTROL UNIT OPERATION	24		

INTRODUCTION (Please read before use)

Voltage

U.S. Version ----- AC110V~120V
General Version ---- AC220V~240V

Heat Dispersion

In order to avoid heat build up, the unit is equipped with a heat dispersion fan for forced air cooling. The air current caused by the fan travels from the left to the right, so be sure to allow enough space on either side for proper circulation (not less than 50 mm).

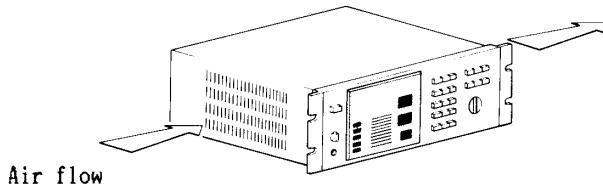

Environmental Temperature

Do not expose this unit to excessive heat. Operating temperature range is between 0 and 40° centigrade (32° and 95° F).

Remote Control Unit Connection

Power to the remote control unit is supplied from the main unit. Do not disconnect the connector while the power of the main unit is on.

Stay for Circuit Boards During Transportation

After unpacking the unit, remove the stay which is inside the main unit and holds its 4 circuit boards. This stay prevents the circuit boards from coming out accidentally during transportation and it must be removed before mounting on the rack or it will not be possible to remove the circuit boards later.

Removal: Remove the two screws on the front panel, and pull down the front panel towards you. Next, remove the four screws holding the top and bottom covers; these covers hold the stay.

Finally, pull the stay out towards you (see section on "REV-1 UNIT LAYOUT" p.34).

Do not throw the stay out, it can be used to secure the circuit boards when the unit is transported again.

External Cleaning

Do not clean the unit with such volatile substances as benzine or paint thinner. Remove dirt and dust with a dry, soft cloth. Internal cleaning should be left to a qualified technician.

SPECIFICATIONS

■ Sound Output Modes

The REV-1 has three output modes:

- a) Direct Sound
- b) Early Reflections
- c) Reverberation

■ Programs

Input Filters

- ① Low Pass Filter 4, 6, 8, 10kHz
- ② High Pass Filter 50, 100, 200, 400Hz

Early Reflections (E/R)

- ① Maximum (L and R) 40 each
- ② Initial Delay (Delay 1)
..... 0 to 600msec

Early Reflection Time 0 to 370msec

E/R Modes (8 types)

- ① ROOM ② HALL-S ③ HALL-M
- ④ HALL-L ⑤ RANDOM ⑥ REVERSE
- ⑦ PLATE ⑧ SPRING

Room Size (8 steps)

$\times 1/8, \times 1/4, \times 1/2, \times 1, \times 2, \times 4, \times 6,$
and $\times 8$

E/R Number (8 steps)

1, 2, 4, 8, 16, 24, 32, 40

Liveness (8 steps)

1, 2, 3, 4, 5, 6, 7, 8
dead→live

Reverberations (REV)

Initial Delay (Delay 2)

..... 0 to 600 msec

Reverberation Time 0.1 to 99.9 sec

Reverberation Modes (8 Types)

- ① Super High Density
- ② High Density/High Initial Diffusion
- ③ High Density/Low Initial Diffusion
- ④ Medium Density
- ⑤ Medium Low Density
- ⑥ Low Density
- ⑦ Super Low Density
- ⑧ Equally Spaced Diffusion

Reverberation Time can be set independently
in Four Frequency Bands

Low (11 steps, standard-Mid-Low range)
 $\times 0.4, \times 0.6, \times 0.8, \times 1.0, \times 1.2, \times 1.4,$
 $\times 1.6, \times 1.8, \times 2.0, \times 2.2,$ and $\times 2.4$

Mid-Low-Standard Reverberation Time

Mid-High (11 steps, standard-Mid-Low range)
 $\times 0.2, \times 0.3, \times 0.4, \times 0.5, \times 0.6, \times 0.7,$
 $\times 0.8, \times 0.9, \times 1.0, \times 1.1,$ and $\times 1.2$

High (11 steps, standard-Mid-Low range)
-5, -4, -3, -2, -1, 0, +1, +2, +3, +4,
and +5

Crossover Frequencies

Low/Mid-Low 125, 250, 500Hz

Mid-Low/Mid-High 1, 2, 4 kHz

■ Main Unit

(input)

Number of Input Channels 1
Circuit Electronically Balanced
Input Impedance .. greater than or equal
to 10 kohms
Nominal input level +4dB
(Headroom14dB)
Maximum Input Level +20dB
Connector XLR-3-31

(Output)

Number of Output Channels
..... 2 (L and R)
Circuit Electronically Balanced
Output Impedance 600 ohms or less
Connector XLR-3-32
Nominal output level +4dB
Maximum output level +18dB
Frequency Response
..... 20Hz to 18kHz +/-1dB

Harmonic Distortion (in Delay Mode)
..... less than or equal to 0.03%
@1kHz during maximum output

Dynamic Range

1.Reverberation Mode85dB
2.Echo Mode85dB
3.Delay Mode90dB

Sampling Frequency 44.1kHz

Number of Quantization Bits 16

Memory

ROM (1~30) 30 sets
RAM (31~90)..... 60 sets

The memory (RAM) is backed up after
cutting power with Ni-Cd batteries.

Environmental Temperature

..... 0 to 40°C (32° to 95° F)

Power Requirements

U.S. Version..... AC110V~120V
General Version AC220V~240V

Power Consumption 150W

Weight 10kg (22 lbs.)

Dimensions (W×H×D)*

..... 18-7/8"×5-1/4"×14-5/8"
(480mm×133mm×372mm)

* Measurements exclude feet, knobs,
connectors, and other protuberances.

■ Remote Control Unit

Liquid Crystal Display (LCD) Modes

W/F = Wave Form
F/C = Filter and Crossover
R/T = Reverberation Time
RATIO = Reverberation Time Ratio
E/R = Early Reflection Mode
REV = Reverb Mode
P/S = Preset Titles
M = Memory Titles

Memory

RAM (91~99)..... 9 sets

Environmental Temperature

..... 0 to 40°C (32° to 95° F)

Power Requirements (Supplied Through
Cable From Main Unit) DC+/-12V

Power Consumption 15W

Weight 1.8kg (4 lbs.)

Dimensions (W×H×D)*

..... 7-3/8"×1-3/4"×11-3/8"
(186mm×45mm×289mm)

Remote Control Cable Length

..... 10m (33 ft.)

* Measurements exclude feet, knobs,
connectors, and other protuberances.

· All specifications subject to change
without notice.

FRONT PANEL CONTROLS

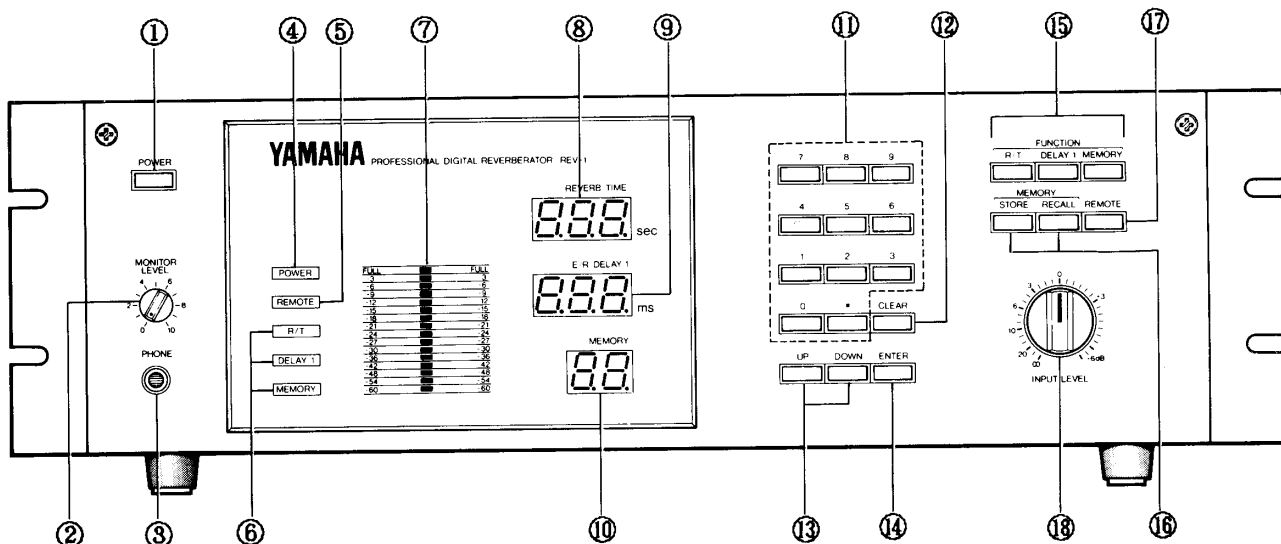

① Power Switch

② Monitor Volume Level Knob

This knob adjusts the level of the signal fed to the headphone amp.

③ Headphone Jack

Stereo headphone jack for monitoring, for use with standard stereo headphones with an impedance of 8 ohms or more.

④ Power Lamp (red)

⑤ REMOTE Indicator

When this indicator is on, the user can operate the remote control unit instead of the controls on the front panel of the main unit. This indicator is turned on or off with the "REMOTE" button.

⑥ Function Indicators-R/T, DELAY1, MEMORY

The function which is under selection with the function buttons in the upper right hand corner of the panel is indicated with these.

⑦ Input Level Meter

Input level (from 0 to -60 dB) is divided into 16 levels (LEDs).

Green -60 to -18 dB

Orange -15 to -3 dB

Red clipping level

The lowest level orange LED (-14dB) is the nominal level.

⑧ REVERB TIME Display

This 3-digit LED indicator displays the reverberation time, at the mid-low frequency band (around 500 to 1,000 Hz). Reverberation time can be selected up to 99.9 sec. in steps of 0.1 sec.

⑨ E/R DELAY (initial Delay) Display

This 3-digit LED indicator displays the delay time between the direct sound and early reflections. It can be selected up to 600 ms in steps of 1 msec. When this delay changes, delay 2 (the time between direct and subsequent reverberations) will also change by the same amount.

⑩ MEMORY (Memory Number) Display

This 2-digit LED indicator displays the number of any of the 90 memories (ROM or RAM). Memories 1 to 30 are preset, read only memories (ROM). The data they contain can be read and set at will. Memories 31 to 90 are user-programmable random access memories (RAM), and therefore can not only be read, but also set by the operator as desired.

⑪ Numeric Buttons (incl. 10 digits and decimal point)

These buttons are used to change the values of each function ("REVERB TIME, DELAY 1, MEMORY"). The user can enter data while monitoring the display of the specified function. They can also be used to clear the value of a specified function on display, or modify the value or when incorrect data must be corrected (see ⑭ "ENTER Button").

⑫ CLEAR Button

Used to clear the value of a specified function on display. Used when data must be modified or to correct mistaken data.

⑬ UP and DOWN Buttons

Used to increase or decrease the value of a specified function. They are convenient in setting the level to an optimum while monitoring.

⑭ ENTER Button

Press this key to enter data from the numeric buttons. Data will not be entered if this button is not pressed before the function is changed with a function button.

⑮ FUNCTION Buttons

R/T (Reverb Time) Function Button

Press this button, and the "R/T" function indicator to the left of the input level meter will light. Reverberation time can now be changed. Monitoring the change of the "REVERB TIME" display to the right of the input level meter, the reverberation time value can be changed with either the ten numeric buttons, or the "UP" and "DOWN" buttons.

DELAY 1 (E/R Delay 1) Function Button

Press this button, and the "DELAY 1" function indicator to the left of the input level meter will light. Early reflection delay data can now be input or altered. Monitoring the change of the "DELAY 1" display to the right of the input level meter, the Delay 1 time value can be changed with either the ten numeric buttons, or the "UP" and "DOWN" buttons. Do not forget to press the "ENTER" button last of all if you wish to enter a new delay time.

"Delay 2" data can be displayed on the "DELAY 1" display by recalling the "DELAY" of memory number 19. To do this, first press the "DELAY 1" function button, and then numeric button "2", and press the "DELAY 1" button again.

Memory Function Button

Press this button, and the "MEMORY" function indicator to the left of the input level meter will light. The memory number can now be changed. Monitoring the change of the "MEMORY" display to the right of the input level meter, the memory number can be changed with either the ten numeric buttons. Press the "STORE" button to write in the memory, or the "RECALL" button to read data from the memory.

⑯ Memory Buttons

STORE (Write) Button

Used to write data into a memory. Press the "MEMORY" function button, specify the memory to be written in with the ten numeric buttons (RAM memories are numbers 31 to 90), and then press this button.

RECALL (Read) Button

Used to read data from a memory. Press the "MEMORY" function button, specify the memory to be recalled in with the ten numeric buttons (both ROM and RAM memories, numbers 1 to 90, can be used), and then press this button to read the data.

⑰ REMOTE Button

Press this button to change to remote control operation. When it is pressed, the "REMOTE" display to the left of the input level meter will light up, meaning that operation is now possible with the remote control unit. Press it again, and the display will turn off, signaling that operation has returned to the front panel controls.

⑱ INPUT LEVEL Control

At 0, input gain will become 1 (nominal), and the output level will be the nominal output level. At this time, with a standard of +4dB, the head room margin becomes +14 dB.

REAR PANEL

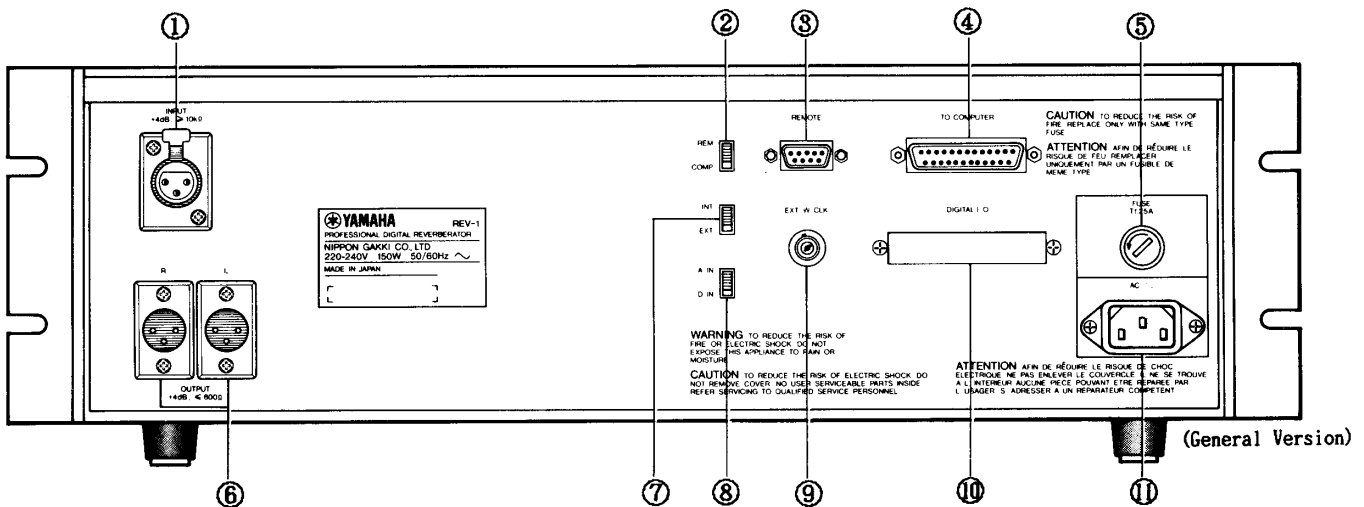

① INPUT (Input XLR Connector)

The balanced XLR (pin 1-ground; pin 2-hot; pin 3-cold) level is +4dB nominal, and headroom is +14dB, with a maximum input level of +20dB, input impedance not less than 10 kohms.

② REM/COMP (Remote Control/Computer Switch)

Switch to "REM" to use the remote control unit, and to "COMP" to use a computer via the RS-232C cable.

③ REMOTE (Remote Control Connector)

This connector is exclusively for the remote control unit.

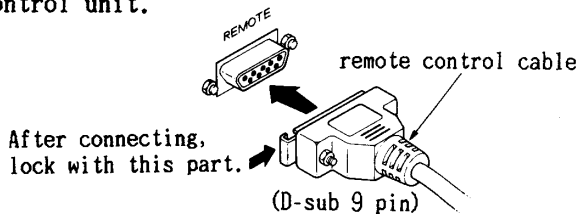

④ TO COMPUTER (Connector for Computer Interface)

D-sub 25 Pin connector, RS-232C compatible.

⑤ FUSE

U.S. Version 3A 250V

General Version T1.25A 250V

⑥ OUTPUT L and R (Output XLR Connectors)

The balanced XLR (pin 1-ground; pin 2-hot; pin 3-cold), level is +4dB nominal, with a maximum output level of +18dB, output impedance- less than or equal to 600 ohms.

⑦ INT/EXT (Word Clock Switch)

Used to switch between the internal word clock (44.1 kHz) or an external word clock (through BNC input). The internal word clock is assumed automatically if no sampling clock is fed to the BNC input; even if this switch is on "EXT" (external).

⑧ A IN/D IN (Analog/Digital Input Selection Switch)

At "A IN", analog input is accepted, and at "D IN", digital input is accepted.

⑨ EXT. W. CLK (External Word Clock Connector)

This terminal can be connected with the word clocks (sampling clocks) of function generators and other digital equipment at the TTL level. The range of the frequency is from 30 kHz to 46.75 kHz (aliasing distortion results when analog input is selected rather than digital input with a sampling frequency of under 40 kHz). In this case, data such as R/T, Delay 1, is automatically adjusted to the micro-computer.

⑩ DIGITAL I/O (Connector for Digital Input/Output)

This is used when an optional unit circuit board is mounted for digital input and output. (D-sub 37 Pin)

⑪ AC~ (AC Inlet)

U.S. Version AC 110V ~120V

General Version AC 220V ~240V

Note: Optional features and computer interfaces are now being planned for future sale.

APPLICATION

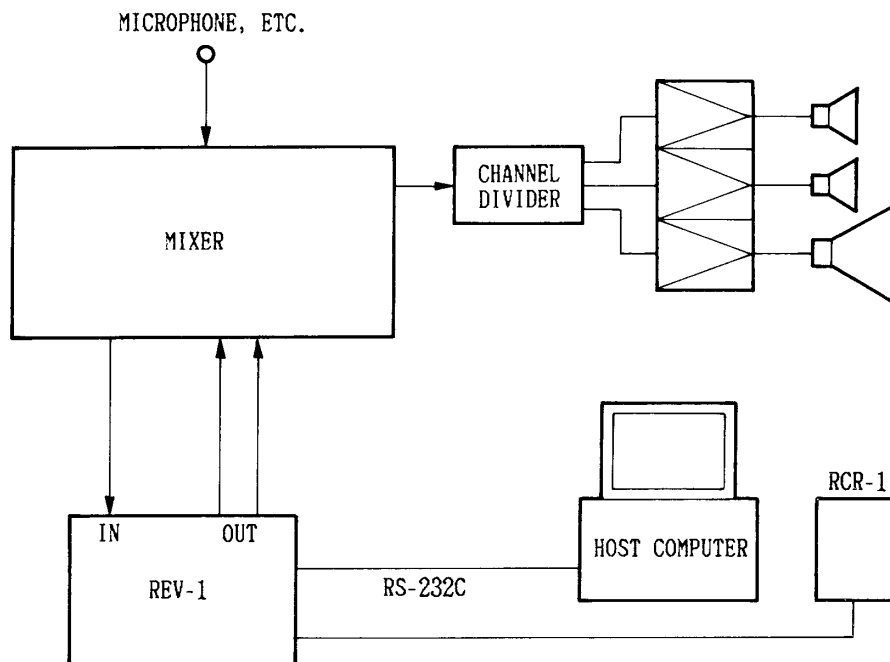
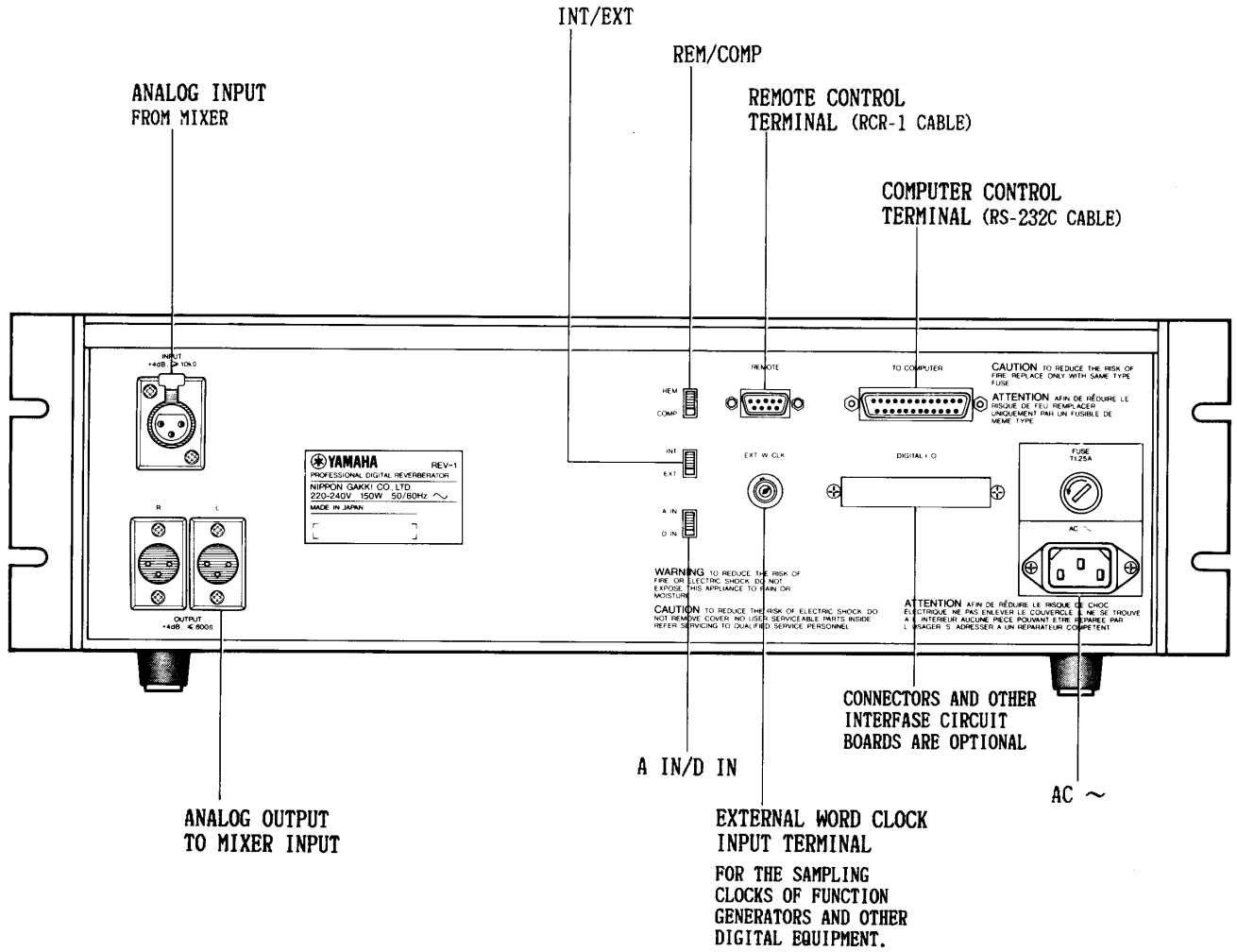

MEMORY LIST

MEMORY (ROM)		USER'S MEMORY (RAM)			
No.	MEMORY TITLES	No.		No.	
1	LARGE HALL	31		61	
2	MIDDLE HALL	32		62	
3	SMALL HALL	33		63	
4	VOCAL PLATE A	34		64	
5	VOCAL PLATE B	35		65	
6	PERCUSSION PLATE A	36		66	
7	PERCUSSION PLATE B	37		67	
8	SPRING	38		68	
9	STRINGS	39		69	
10	ELECTRIC BASS	40		70	
11	PIANO	41		71	
12	ORGAN	42		72	
13	BRASS	43		73	
14	GUITAR	44		74	
15	HANDCLAP	45		75	
16	SNARE	46		76	
17	KICK	47		77	
18	ECHO ROOM	48		78	
19	DELAY	49		79	
20	STEREO ECHO	50		80	
21	STEREO FLANGE	51		81	
22	STEREO PHASING	52		82	
23	TREMOLO	53		83	
24	CHORUS A	54		84	
25	CHORUS B	55		85	
26	CONSTANT DENSITY A	56		86	
27	CONSTANT DENSITY B	57		87	
28	CONSTANT DENSITY C	58		88	
29	LIVE REFERENCE	59		89	
30	L=E/R, R=REV	60		90	

MEMORY (ROM) : Read Only Memory

USER'S MEMORY (RAM) : Random Access Memory

REMOTE CONTROL UNIT

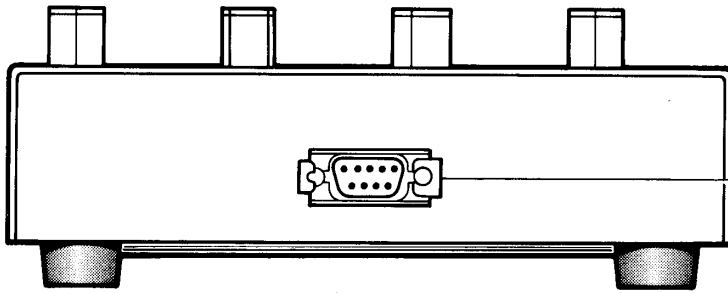

SECTION V
(Page 21)

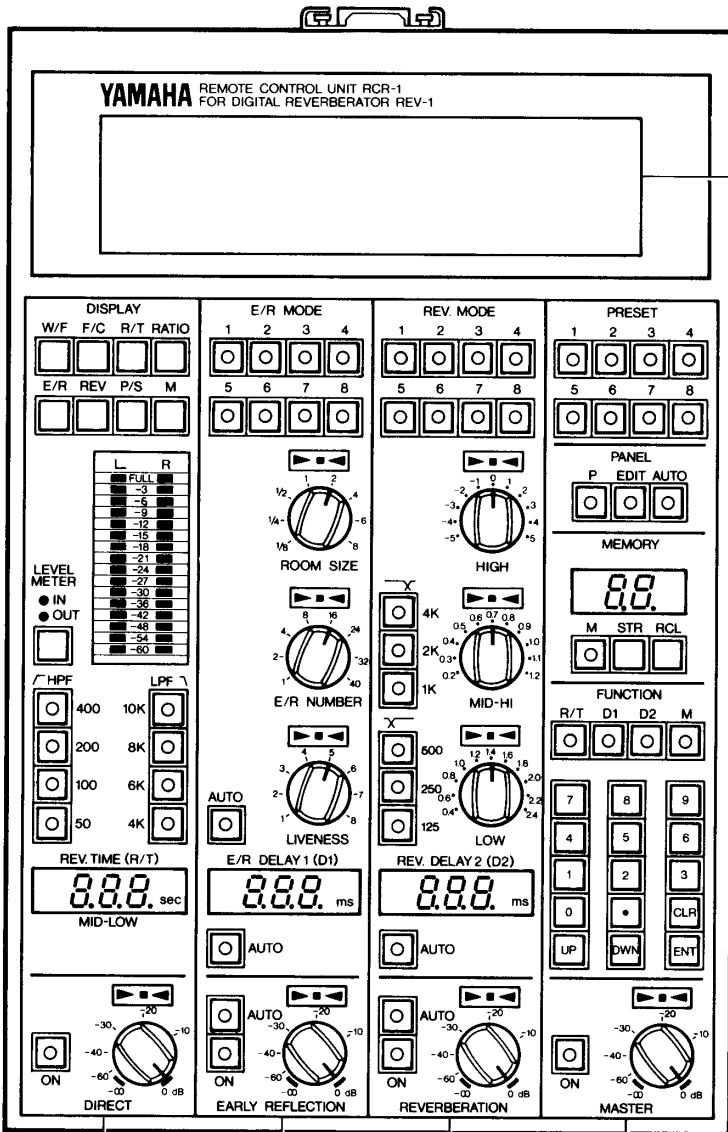

SECTION VI
(Page 21)

SECTION I
(Page 13)

SECTION III
(Page 17)

SECTION II
(Page 15)

SECTION IV
(Page 19)

(SECTION I)

① DISPLAY MODE (Display mode selection) Keys

Used to select one of eight display modes (see: "Remote Control Displays" on page 32).

② LEVEL METER

This meter will show either the input or the output level (from 0 to -60 dB) divided into 16 divisions of LEDs (see next two paragraph on IN/OUT indicator and key). The clipping level is shown by the red LEDs. Nominal input level is -14dB, and nominal output level is -14dB on the meter.

③ IN and OUT Indicators

These two LEDs light to show what the level meter is indicating, either input ("IN") or output ("OUT").

④ IN/OUT (Level Meter Switching) Key

Press this key to change the level meter to indicate either input, or output.

⑤ HPF (High Pass Filter) and LPF (Low Pass filter) Keys

Used to select the cut-off frequencies for the high pass filter and the low pass filter. These filters are located after the A/D converter on the circuit. Press these keys only after having pressed the "EDIT" key located in the upper right hand corner of the unit. The LEDs in the center of the keys will light when the key is pressed, to show that its frequency is under selection. Press the key again, or another of the keys in the same row, and the LED will go out. The filters currently under selection can also be displayed on the LCD with the crossover frequency display mode (the "F/C" key, for this display mode, is in the first row of keys in the display group of keys).

⑥ REV. TIME (R/T) Display

This is a 3-digit LED indicator. It displays reverberation time at the mid-low frequency band (around 500 Hz to 1 kHz). It can be selected up to 99.9 sec. in steps of 0.1 sec.

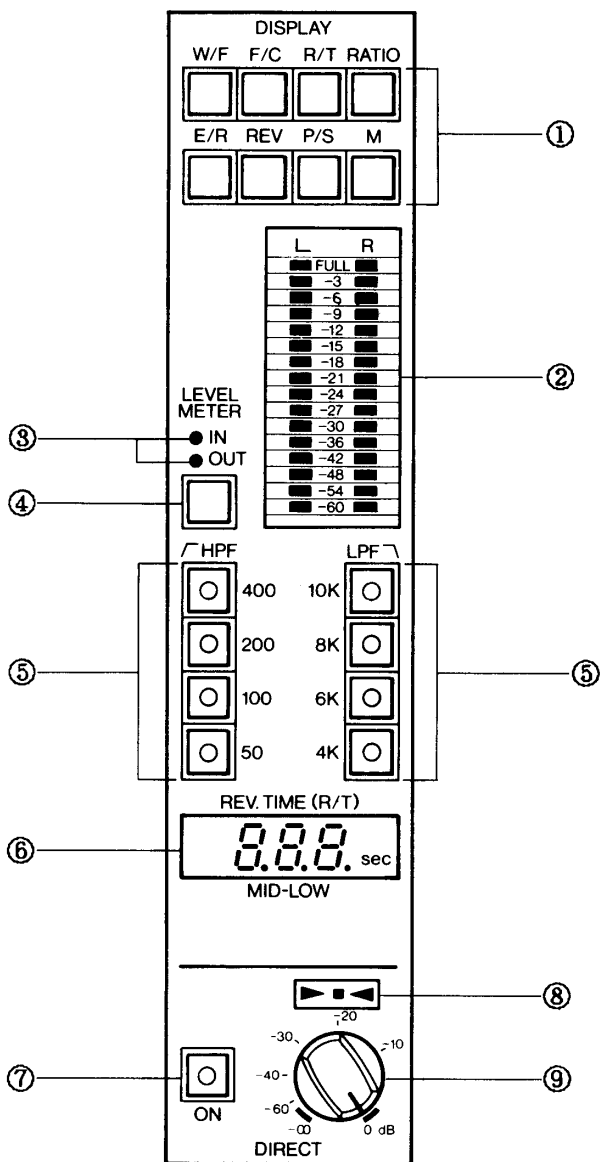

⑦The DIRECT ON Key

This key is in the "DIRECT" section of the panel. It is used to select or cut off the input of direct sound. Press this key only after having pressed the "EDIT" key located in the upper right hand corner of the unit. When the key is pressed, and the LED lights, direct sound input is allowed; if it turns off, direct sound input is cut off.

⑧The DIRECT Sound Level Indicator

This is the set of three LEDs in the "DERECT" section of the panel. One of these three LEDs will light when a memory is called up:

"▷" When this LED lights, the direct sound level of the memory which has been called up is higher than the level indicated by the current position of the control.

"□" When this LED lights, the direct sound level of the memory which has been called up is the same as the level indicated by the current position of the control.

"◁" When this LED lights, the direct sound level of the memory which has been called up is lower than the level indicated by the current position of the control.

⑨The DIRECT Sound Level Control

Used to control the mixing level of direct sound. The direct sound input is mixed with early reflection and subsequent reverberation input, and the mixed output is controlled by the "MASTER" level control. Set the direct sound level with the following procedure:

1. Press the "EDIT" key in the upper right hand corner of the unit.
2. Rotate the "DIRECT" sound level control until the LED in the center of the level indicator lights. Now the direct sound level is ready to be modified.

① E/R MODE (Early Reflection Mode Select) keys

Used to select one of the eight different basic early reflection modes after pressing the "EDIT" key. Selection of one of these modes is the first step made after recalling a memory, in order to make early reflection settings. The eight modes are as follows:

- 1 = ROOM
- 2 = HALL-S (small)
- 3 = HALL-M (medium)
- 4 = HALL-L (large)
- 5 = RANDOM
- 6 = REVERSE
- 7 = PLATE
- 8 = SPRING

Echo time patterns for each mode are shown on page 39. The relationship between "ROOM SIZE" settings (1/8 to 8) and the actual volume of the "ROOM" (m³) for each mode is shown on page 40.

② ROOM SIZE Indicator

This is the set of three LEDs above the "ROOM SIZE" selector. It is used to indicate if the room size value read from a memory is larger than, smaller than, or equal to the current setting of the "ROOM SIZE" selector underneath it.

③ ROOM SIZE Selector

Used to select one of the eight preset room size values (1/8 to 8). When the room size setting is changed, early reflections also change. When operating this selector, first press the "EDIT" key in the upper right hand corner of the unit, and then rotate the selector in the direction indicated by the room size indicator, until the LED in the center of the indicator lights. Then, the setting can be changed if desired.

④ E/R NUMBER Indicator

This is the set of three LEDs above the "E/R NUMBER" selector. It is used to indicate if the number of early reflections read from a memory is larger than, smaller than, or equal to the current setting of the "E/R NUMBER" selector underneath it.

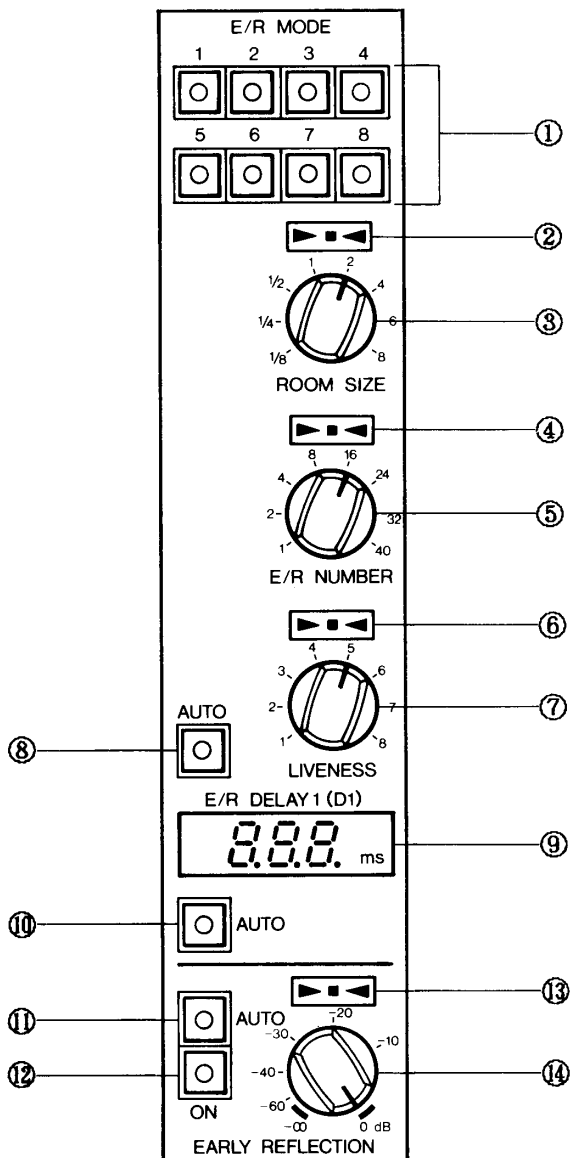

⑤ E/R NUMBER (Early Reflection Selector)

This selector has eight settings in a range from 1 to 40.

To change the E/R number, first press the "EDIT" key in the upper right hand corner of the panel, and then adjust the E/R selector until the LED in the center of the E/R indicator above the selector lights. Then, the setting can be changed if desired.

⑥ LIVENESS Indicator

This is the set of three LEDs above the "LIVENESS" selector. It is used to indicate if the liveness value read from a memory is larger than, smaller than, or equal to the current setting of the "LIVENESS" selector underneath it.

⑦ LIVENESS Selector

Sound absorption (attenuation) can be adjusted within a range of eight settings (1 to 8). The closer to "8", the more "live" the sound output will be, and the closer to "1", the more "dead" the sound output will be.

To change the liveness setting, first press the "EDIT" key in the upper right hand corner of the panel, and then adjust the control until the LED in the center of the liveness indicator above lights. Then, the liveness value can be changed if desired.

⑧ The Liveness AUTO key

To use this key, first press the "P" key in the upper right hand corner of the panel. Then press the key, and the LED in the center will light. At this time, the liveness value becomes automatically controlled, and is set to a standard value which is calculated according to the reverberation time.

⑨ E/R DELAY (D1) Display

This is a 3-digit LED indicator. It displays the difference in time between the direct sound and the arrival of the first early reflection. The early reflection delay time can be set from 0 to 600 msec in steps of 1 msec.

⑩ E/R Delay AUTO Key

When this key is lit, the early reflection delay time will be controlled automatically and will be set to a standard value which is calculated according to the E/R mode and the "ROOM SIZE". To operate, first press the "P" key in the upper right hand corner of the panel, then press this key.

⑪ E/R Level AUTO Key

When this key is lit, the early reflection level is controlled automatically, and set to the maximum level. Press the "P" key in the upper right hand corner of the panel before using this key.

⑫ EARLY REFLECTION ON Key

Press the "EDIT" key in the upper right hand corner of the panel before using this key. When lit, early reflections are sent to the output; when pressed again, the LED goes out, and early reflections are removed from the output.

⑬ E/R Level Indicator

This is the set of three LEDs above the "EARLY REFLECTION" selector. It is used to indicate if the E/R value read from a memory is larger than, smaller than, or equal to the current setting of the "EARLY REFLECTION" selector underneath it.

⑭ EARLY REFLECTION Level Control

Press the "EDIT" key in the upper right hand corner of the panel before using this level control. Then adjust it until the LED in the center of the indicator above is lit. After that, it can be adjusted. It controls the output level of the early reflections which are then mixed with the "DIRECT" sound and "REVERBERATION" outputs; the result of which is controlled by the "MASTER" level control in the lower right hand corner of the panel.

(SECTION III)

① REV.MODE (Reverberation Mode Setting) keys

One of these keys can be set as standard for reverberation output:

- 1 - SHD (Super High Density)
- 2 - HD/HID (High Density/High Initial Diffusion)
- 3 - HD/LID (High Density/ Low Initial Diffusion)
- 4 - MD (Medium Density)
- 5 - MLD (Medium LOW Density)
- 6 - LD (Low Density)
- 7 - SLD (Super Low Density)
- 8 - ESD (Equally Spaced Diffusion)

Press the "EDIT" key in the upper right hand corner of the panel before using these keys. Press the "REV" key of the "DISPLAY" group of keys in the upper left hand corner of the panel, and the LCD will show the mode under selection.

② HIGH Indicator

This is the set of three LEDs above the "HIGH" selector. It is used to indicate if the high range reverberation time value read from a memory is larger than, smaller than, or equal to the current setting of the "HIGH" selector underneath it.

③ HIGH (High Range Reverberation Time) Selector

Press the "EDIT" key in the upper right hand corner of the panel before using this selector. Then adjust it until the LED in the center of the indicator above is lit. After that, it can be adjusted. Settings can be made in a range of 11 settings from -5 to +5. The high range reverberation time (later reverberation time) settings are in reference to those of the mid-low range.

④ MID-HI Indicator

This is the set of three LEDs above the "MID-HI" selector. It is used to indicate if the mid-high range reverberation time value read from a memory is larger than, smaller than, or equal to the current setting of the "MID-HI" selector underneath it.

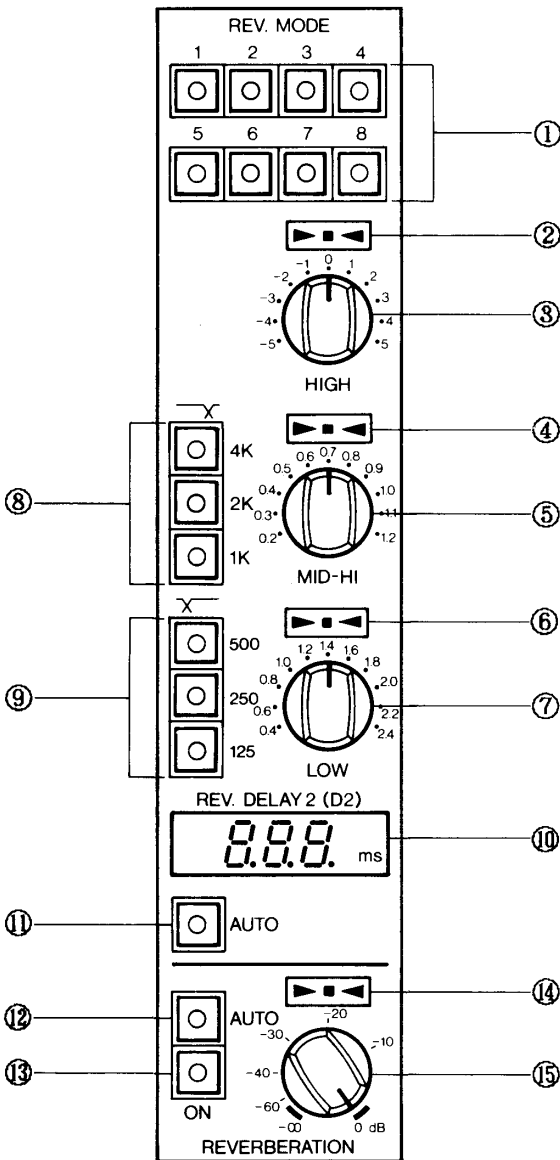

⑤ MID-HI (Mid-High Range Reverberation Time) Selector

Press the "EDIT" key in the upper right hand corner of the panel before using this selector. Then adjust it until the LED in the center of the indicator above is lit. After that, it can be adjusted. Settings can be made in a range of 11 settings from 0.2 to 1.2. The mid-high range reverberation time (later reverberation time) settings are in reference to those of the mid-low range (which becomes 1.0).

⑥ LOW Indicator

This is the set of three LEDs above the "LOW" selector. It is used to indicate if the low range reverberation time value read from a memory is larger than, smaller than, or equal to the current setting of the "LOW" selector underneath it.

⑦ LOW (Low Range Reverberation Time) Selector

Press the "EDIT" key in the upper right hand corner of the panel before using this selector. Then adjust it until the LED in the center of the indicator above is lit. After that, it can be used. Settings can be made in a range of 11 settings from 0.4 to 2.4. The low range reverberation time (later reverberation time) settings are in reference to those of the mid-low range (which becomes 1.0).

⑧ 4K, 2K, and 1K Keys

These three keys are located to the left of the "MID-HI" selector. Press the "EDIT" key in the upper right hand corner of the panel before using them. They are used to set the crossover frequency between the "MID-HI" range, and the "MID-LOW" range.

⑨ 500, 250, and 125 Keys

These three keys are located to the left of the "LOW" selector. Press the "EDIT" key in the upper right hand corner of the panel before using them. They are used to set the crossover frequency between the "MID-LOW" range, and the "LOW" range.

⑩ REV. DELAY 2 (D2) Display

This is a 3-digit LED indicator. It displays the difference in time between the direct sound and the arrival of the first subsequent reverberation. The subsequent reverberation delay time can be set from 0 to 600 msec in steps of 1 msec.

⑪ REV. Delay AUTO Key

When this key is lit, the subsequent reverberation delay time will be controlled automatically and will be set to a standard value (Delay 1 +15ms). To operate, first press the "P" key in the upper right hand corner of the panel, then press this key.

⑫ REV. Level AUTO Key

When this key is lit, the subsequent reverberation level is controlled automatically, and set to a standard. Press the "P" key in the upper left hand corner of the panel before using this key.

⑬ REVERBERATION ON Key

Press the "EDIT" key in the upper right hand corner of the panel before using this key. When lit, subsequent reverberation is on the output; when pressed again, the LED goes out, and subsequent reverberation is cut.

⑭ REV. Level Indicator

This is the set of three LEDs above the "REVERBERATION" selector. It is used to indicate if the reverberation value read from a memory is larger than, smaller than, or equal to the current setting of the "REVERBERATION" level control underneath it.

⑮ REVERBERATION Level Control

Press the "EDIT" key in the upper right hand corner of the panel before using this level control. Then adjust it until the LED in the center of the indicator above is lit. After that, it can be used. It controls the output level of the subsequent reverberation, which is then mixed with the "DIRECT" sound and "EARLY REFLECTION" outputs; the sum of which is controlled by the "MASTER" level control in the lower right hand corner of the panel.

(SECTION IV)

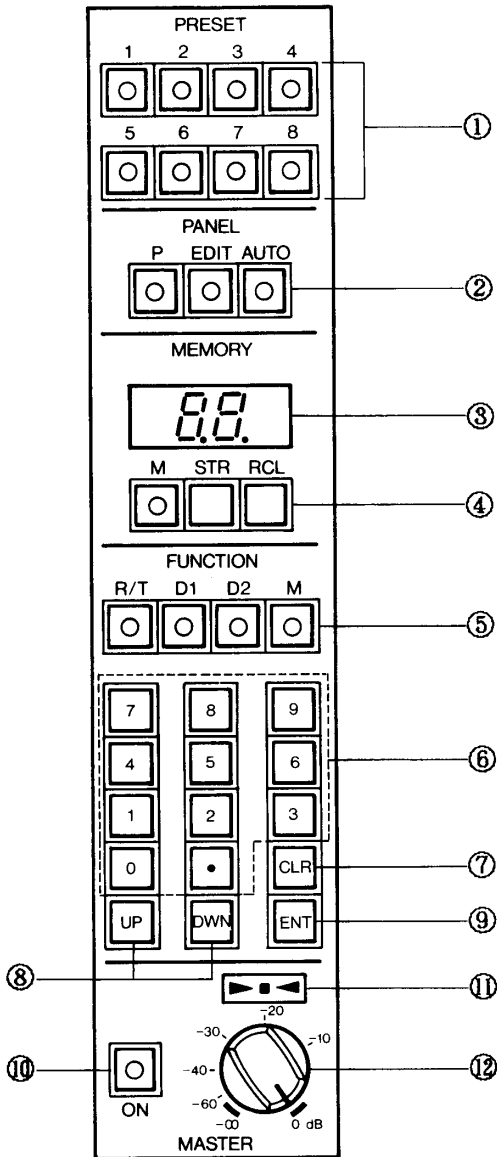

① PRESET Keys

These keys are located at the top of the far right column of the panel. When the unit leaves the factory, they are pre-set with data from the ROM, numbers 1 to 8. The user can change these settings at will, using data from any one of the 90 memories (ROM and RAM included). They are used to simplify operation because the data recorded with these keys can be read instantly.

* See page 31 item 19.

② PANEL Keys

P
This key is used to set parameters without utilizing pre-set or memory data. Press this key, and the LED in the middle will light. At this time parameters indicated by the current settings of keys and controls can now be set, or modified and set.

EDIT
This key is used to modify preset or memory data. If the LED of the "P" key is still lit, this key cannot be used. Press this key, and the LED in the middle will light. At this time, parameters are ready to be edited.

AUTO
This key is used to turn all "AUTO" keys on or off simultaneously. It can be used only when the LED of the "P" key is lit.

③ MEMORY Display

This is a 2-digit LED indicator. It will display memory numbers from 1 to 99. Memories from 1 to 30 have parameters already set. They can be recalled and used. Adjusted data can be stored in user-programmable memories 31 to 99.

④ MEMORY Keys

M (Memory) Key
This key is used to recall or store data in a memory. Press this key, and whether or not the "MEMORY" display is lit, the current memory number will be shown on the "MEMORY" display.

STR (Store) Key
This key is used to store adjusted data in a memory. Press the "M" key, specify the memory number (31 to 90) with the ten-key numeric pad, and finally, press this key.

RCL (Recall) Key
This key is used to recall data in a memory. Press the "M" key, specify the memory number (1 to 90) with the ten-key numeric pad, and finally, press this key.

⑤ FUNCTION Keys

R/T (Reverb Time) Key

Press the "EDIT" key before using this key. Press this key, and the LED in the middle will light. Reverberation time can now be changed. Monitoring the change on the "REV. TIME" display in the far left column, above the "DIRECT" sound level control, the reverberation time value can be changed with either the ten numeric keys, or the "UP" and "DOWN" keys. Do not forget to press the "ENTER" key last of all for input with the numeric keys.

D1 (Delay 1) Key

Press the "EDIT" key before using this key. Press this key, and the LED in the middle of the key will light. Early reflection delay data can now be entered or altered. Monitoring the change on the "E/R DELAY 1 (D1)" display in the second to the far left column, above the "EARLY REFLECTION" level control, the DELAY 1 value can be changed with either the ten numeric keys, or the "UP" and "DOWN" keys. Do not forget to press the "ENTER" key last of all for input with the numeric keys. Pressing this key and the "D2" key at the same time will enable you to modify the DELAY 1 and DELAY 2 data with the same value simultaneously (see number 15 of the "Front Panel Controls" section).

D2 (Delay 2) Key

Press the "EDIT" key before using this key. Press this key, and the LED in the middle of the key will light. Subsequent reverberation delay data can now be entered or altered. Monitoring the change on the "REV. DELAY 2 (D2)" display in the second to the far right column, above the "REVERBERATION" level control, the DELAY 2 value can be changed with either the ten numeric keys, or the "UP" and "DOWN" keys. Do not forget to press the "ENTER" key last of all for input with the numeric keys.

M (Memory) Key

Press the "EDIT" key before using this key. Press this key, and the LED in the middle of the key will light. The memory number can now be changed. Monitoring the change of the "MEMORY" display above, the memory number can be changed with the ten numeric keys. Press the "STR (store)" key to write in the memory, or the "RCL (recall)" key to read data from the memory.

⑥ Ten-Key Numeric Pad (incl. 10 digits and decimal point)

These keys are used to change the values of each function (E/R DELAY 1, REV DELAY 2, MEMORY). The user can enter data while monitoring the display of the specified function.

⑦ CLEAR Key

Used to clear the value of a specified function on display. Used when data must be modified or to correct incorrect data.

⑧ UP and DOWN Keys

Used to increase or decrease the value of a specified function (except for memory numbers). They are convenient in setting the level to an optimum while monitoring.

⑨ ENT (Enter) Key

Press this key to enter data from the numeric keys. Data will not be entered if this key is not pressed before the function is changed with a function key.

⑩ MASTER ON Key

Press the "EDIT" key in the upper right hand corner of the panel before using this key. When lit, the mixed signal will be on the output; when pressed again, the LED goes out, and the mixed signal will be cut from the outputs.

⑪ MASTER Level Indicator

This is the set of three LEDs above the "MASTER" selector. It is used to indicate if the mixed signal read from a memory is larger than, smaller than, or equal to the current setting of the "MASTER" level control underneath it.

⑫ MASTER Level Control

Press the "EDIT" key in the upper right hand corner of the panel before using this level control. Then adjust it until the LED in the center of the indicator above is lit. After that, it can be used. It controls the output level of the mixed signal, which contains the "DIRECT" sound, "EARLY REFLECTION", and "REVERBERATION" outputs.

{SECTION V}

Remote Control Cable Connector

See rear panel operation instructions,
number 3.

{SECTION VI}

Remote Control Unit LCD (Display) Panel

This is an 64×240 dot matrix LCD, with EL
(electroluminescent) panel lighting.
Characters and figures are displayed for the
current data settings.

BASIC OPERATION

Although the operation procedure required is variable, depending on the type of reverberation desired, basic operation will be described in the following.

BEFORE SETTING :

- ① Are all the I/O and power cord connections properly made ?
- ② Is the REM/COM switch set correctly?
- ③ Is the remote control unit or computer connector properly connected?
- ④ Is the INT/EXT switch set correctly (use BNC connectors for external clock input selection, 30 to 46.75 kHz, TTL level) ?
- ⑤ Is the A IN/D IN switch set correctly?
- ⑥ Is the headphone set connected properly?

FRONT PANEL OPERATION

FRONT PANEL

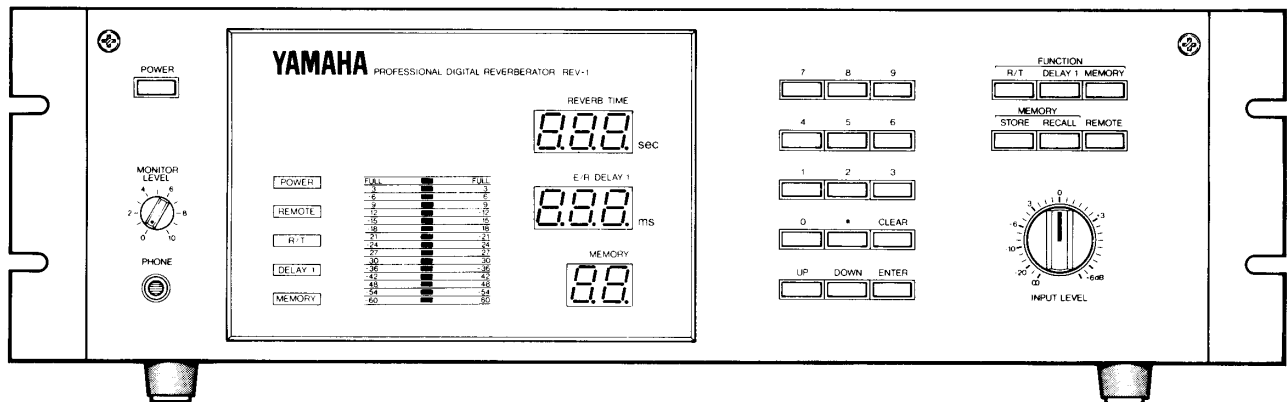

The following two operations are possible with front panel operation :

- A. Setting the parameters read from a memory without modifying them (see operations 1 to 4 in the explanation below).
- B. Setting the parameters read from a memory and modifying those parameters resulting in a new reverberation time. When initial delay (DELAY 1) is changed, the delay time between the direct sound and the subsequent reverberation (DELAY 2) is also changed accordingly. The modified setting of parameters can be stored in user-programmable memories 31 to 90 (see operations 1 to 6 in the explanation below).

1. Power On

Turn on the power. All LED indicators on the front panel will light up for a few seconds before the data at the last power down is displayed with them.

2. Remote Indicator

When the remote indicator is on, press the "REMOTE" to turn the remote indicator off, and to enable front panel operation to be selected.

3. Adjusting Input Level

Adjust the input level using the send level control in the console, and the input level control of the main unit (REV-1).

4. Recalling Data in Memories

- a. Press the "MEMORY" function button. The "MEMORY" indicator will light up.
- b. Enter the memory number that you wish to recall with the ten numeric buttons. The entered memory number will blink on the "MEMORY" display (see the "Memory List" on page 11 for titles in the memory).
- c. Press the "RECALL" memory button. The indicated memory number will stop blinking, and the memory data will be set.*

* This operation calls up the reverberation sound stored in the specified memory. Repeat procedures b. and c. to recall another memory. Follow steps 5 and 6 to modify the data read from a memory.

5. Adjusting the Reverberation Time (R/T)

The reverberation time is variable up to 99.9 sec. in steps of 0.1 sec.

- a. Press the "R/T" function button. The "R/T" indicator located just above the ten key numerical pad will light.
- b. Enter the reverberation time that you wish to set with the ten numeric buttons. The entered value will blink on the "REVERB TIME" display.
- c. Press the "ENTER" button. The "REVERB TIME" display will stop blinking, and the entered data will be set.*

* Follow step 6 for adjusting "DELAY 1" and step 7 for storing the current data setting

6. Adjusting the Initial Delay (DELAY 1)

When the reverberation sound has been read from a memory, DELAY 1 (delay between the direct and early reflections) and DELAY 2 (delay between the direct and subsequent reverberation) are automatically set. Only DELAY 1 can be seen on the LED display. Changing (D1) on the front panel will change REV (D2) by the same amount. Therefore, the overall reverberation characteristics, including the relationship between the early reflections and the subsequent reverberation, remain unaffected. DELAY 1 is variable up to 600 msec. in steps of 1 msec.

- a. Press the "DELAY 1" function button. The "DELAY 1" indicator will light up.
- b. Enter the value for "DELAY 1" with the ten numeric buttons. The entered value will blink on the "DELAY 1" display. DELAY 1 can also be fine-adjusted with the "UP" and "DOWN" buttons. Use of the "UP" and "DOWN" buttons will eliminate the necessity of the following step (C.).
- c. Press the "ENTER" button. The "DELAY 1" display will stop blinking, and the entered data will be set.*

* Follow step 7 for storing the current data setting in a memory.

7. Memories

Adjusted data can be stored in user-programmable memories 31 to 99. Use the "MEMORY List" on page 11 to keep titles for programs in memories 31 to 99.

- a. Press the "MEMORY" function button. The "MEMORY" indicator will light up.
- b. Enter the memory number with the ten numeric buttons. The entered memory number will blink on the "MEMORY" display.
- c. Press the "STORE" memory button. The memory display will stop blinking, and the current data will be stored in the specified memory.

■ REMOTE CONTROL UNIT OPERATION

Read this section carefully, and refer to the panel illustration on page 12. The following three operations can be performed with the remote control unit:

- A. Selection of one of the preset memories with the 8 "PRESET" keys (see steps 1 to 4); and reading and modifying the parameters set in one of the 8 preset memories (see steps 1 to 7).
- B. Recall from one of the 30 memories of the ROM, using the "M" memory key, the "M" function key, and the ten-key numeric pad (see steps 1 to 4); or recall and the modification of the parameters recalled (see steps 1 to 7).
- C. Using the "P" (panel) key to set desired parameters without utilizing presets or memories (see steps 1 to 7).

1. Power On

Turn on the power with the power switch on the front panel of the main unit. The LCD will show the following display for a few seconds before the data at the last power down will be displayed.

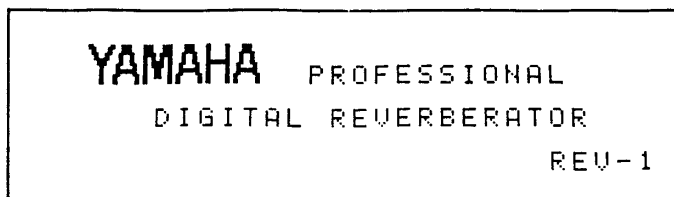

This, however, is only when the "REMOTE" indicator of the main unit is on. If it is not, see the next step.

2. Remote Selection

Press the "REMOTE" button to select remote control operation. The "REMOTE" indicator on the front panel will light up, and the data at the last power down will be displayed on the LCD of the remote control unit.

3. Adjusting the Input Level

There is no control for the adjustment of the input level on the remote control unit. However, if "IN" is selected with the "IN/OUT" key of the level meter, the input level can be monitored. Adjust the input level with the send level control of your console, or the input level control of the main unit.

4. SETTING METHOD SELECTION

A. Reading Pre-set Key Data

- ① First, see SECTION IV for information about the pre-set keys (1 to 8) of the remote control unit. Press the desired "PRESET" key, to set the data. A display such as the one below will come on the LCD for 1 or 2 seconds.

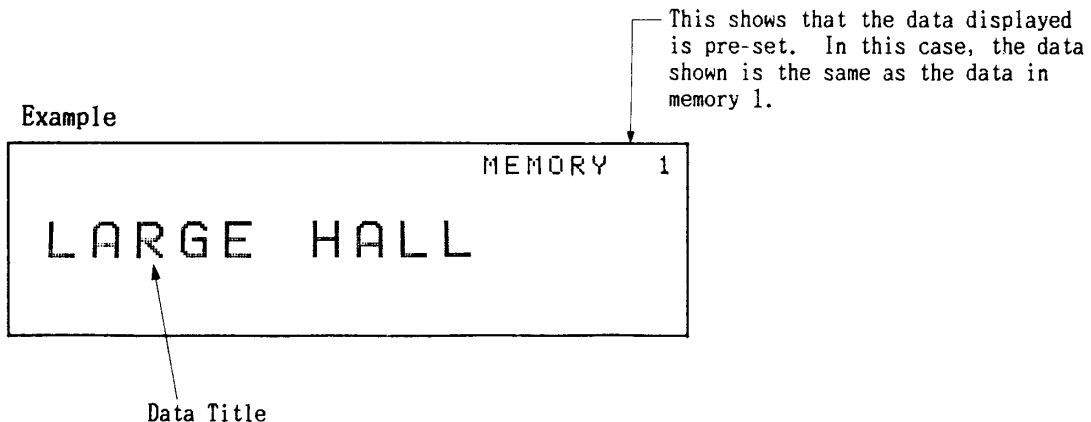

After 1 or 2 seconds, the display will change to the graphical type (depending on the selection with the "DISPLAY" keys), and the data will be set.

- ② To alter the pre-set data, press the "EDIT" key, and see the next operation example.

B. Reading Memory Data

- ① Press the "M" memory key (see SECTION IV).
- ② Use the ten-key numerical pad to specify the number of the desired memory. The memory number will blink on the LCD (see the "Memory List" on page 11).
- ③ Press the "RECALL" memory key, and the contents of the memory will be displayed on the LCD. The contents of the memory will now have been set.
- ④ To alter the data read from a memory, press the "EDIT" key and see the next operation example.

C. Creating New Data

- ① Press the "P" panel key (see SECTION IV), new data can now be entered at will with the various controls of the remote control unit. Or:
- ② Press the "AUTO" panel key. The LED in the center of the key will light up, and all parameters will an "AUTO" key will be set to a standard value. Press it one more time, and bring the unit out of auto mode; or:
- ③ To break out of auto mode for each parameter separately, and set manually, press each key separately. When pressed, the LED of the key will turn off.

5. INPUT FILTER SELECTION

- ① Press the "F/C" display key (see SECTION I). The LCD will display the present cutoff and crossover frequency status.

Example

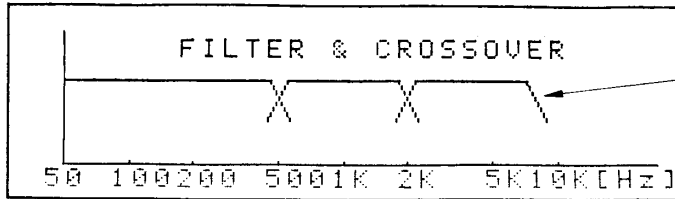

This display shows that the cutoff is for 8 kHz and above; the "8K" LPF key has been pressed.

- ② Use one of the "50, 100, 200, or 400" HPF keys to cut off lower bands. When pressed, the LED of the key will light up, and the LCD graphical display will change accordingly. By pressing a lit key, output can be sent through.
- ③ To cut off higher bands, press one of the "4K, 6K, 8K, or 10K" keys. When pressed, the LED of the key will light up, and the LCD graphical display will change accordingly. By pressing a lit key, output can be sent through.

6. ADJUSTMENT OF REVERBERATION TIME

- ① Press the "R/T" function key. The LED of the key will light up.
- ② Press one of the display keys: "W/F, R/T, RATIO" to specify what display you want; and the LCD will change graphical display appropriately.

Example (R/T Mode)

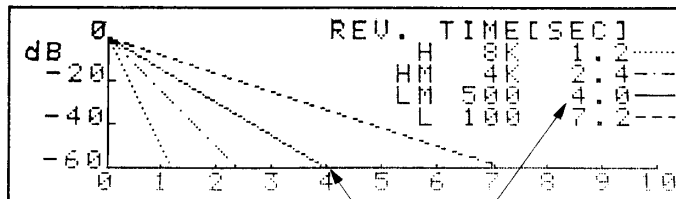

In this display, R/T has been set at 4 seconds.

- ③ Use the ten-key numerical pad to specify the desired reverberation time. The specified value will blink on the "REV. TIME" display. At this time, the "UP" and "DOWN" keys can be used to alter the data. If these keys are used, there is no need for the next step (4).
- ④ Press the "ENTER" key. The "REV TIME" display will stop blinking, and the displayed data will be set, and the LCD will change the graphical display accordingly.

7.E/R MODE SELECTION

- ① Press the "E/R" display key. The LCD will change display.

Example

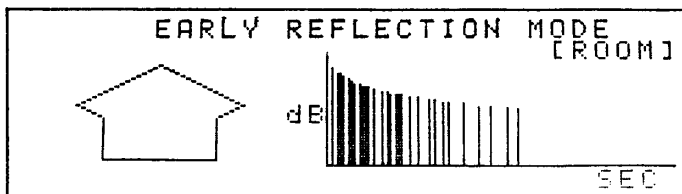

- ② Press one of the 8 "E/R MODE" keys (see SECTION II). The sound of the output will change accordingly (The quality of the sound output is affected the most by composition of the early reflections). The LCD graphical display will also change.

8.ROOM SIZE ADJUSTMENT

- ① Leave the LCD display on "E/R".
- ② Use the "ROOM SIZE" selector to select any setting desired. While the early reflection delay time changes, the level will change according to the attenuation curve which results from the "LIVENESS" selector setting. However, this unit will not output early reflection sounds which have a delay time that exceeds 370 msec.

9.E/R NUMBER ADJUSTMENT

- ① Leave the LCD display on "E/R".
- ② Use the "E/R NUMBER" selector to select any setting desired. The amount of early reflections will change accordingly.

10.LIVENESS ADJUSTMENT

- ① Leave the LCD display on "E/R".
- ② Use the "LIVENESS" selector to select any setting desired. The attenuation of the early reflections, and sound image will change accordingly.

11. E/R DELAY ADJUSTMENT

- ① Press the "W/F" display key. The LCD will change to the "W/F" display, and you will be able to check the relationship between the early reflections and the composition of the sound output as a whole.

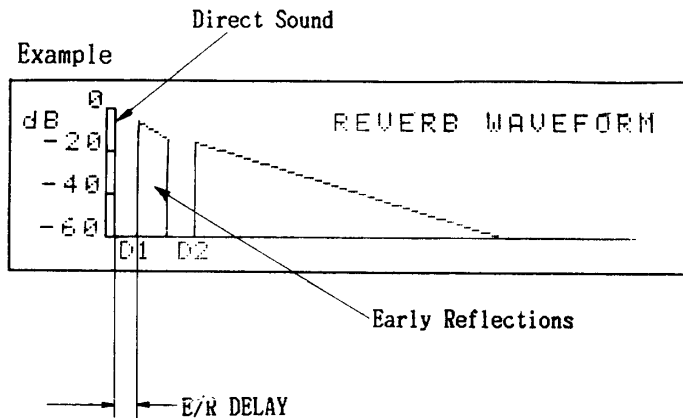

- ② Press the "D1" function key.*
- ③ Specify the desired early reflection delay time value with the ten-key numerical pad. This value will blink on the "E/R DELAY" display. At this time, you may use the "UP" and "DOWN" keys to alter the data. If these keys are used, there is no need for the next step (4).
- ④ Press the "ENTER" key. The "E/R DELAY" display will stop blinking, and the displayed data will be set, and the LCD graphical display of the early reflection waveform will change accordingly.

* Note that the "D2" key can also be used. Press both the "D1" and the "D2" keys together, and without changing the relationship between early reflections and reverberation, you can change delay movement (this can also be done on the front panel, see "Adjusting Initial Delay").

12. REVERBERATION MODE SELECTION

- ① Press the "REV" display key. The LCD will change to the "REV" display.

Example: "REV. MODE" Display

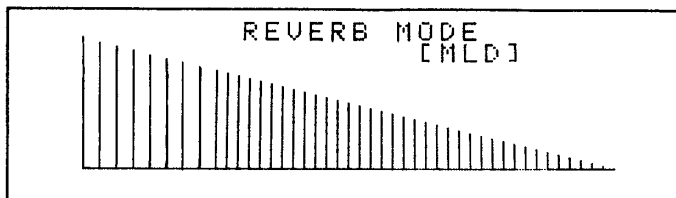

- ② Press any one of the 8 "REV. MODE" keys (see SECTION III). The reverberation density will change accordingly.

13. CROSSOVER FREQUENCY SETTING

- ① Press the "F/C" display key. The LCD will display the graphical display for the crossover frequencies and the cutoff status.

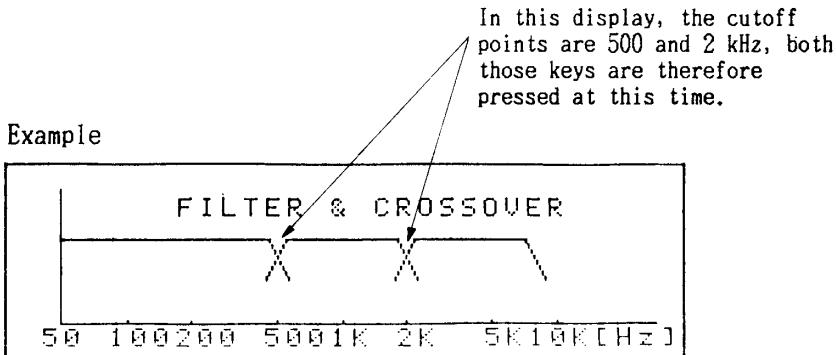

- ② Press one of the "4K, 2K, or 1K" keys (see SECTION III). The LED in the center of the key will light up, and the mid-low and mid-high band crossover frequencies will be set. The LCD display will also change accordingly.
- ③ Press one of the "500, 250, or 125" keys (see SECTION III). The LED in the center of the key will light up, and the low and mid-low band crossover frequencies will be set. The LCD display will also change accordingly.

14. REVERBERATION TIME ADJUSTMENT BY FREQUENCY BAND

The mid-low band value set in (6) will be the standard value, and in this operation the reverberation time for the other three bands will be altered.

- ① Press either the "R/T" or the "RATIO" display key. The LCD will show the relationship between the different bands of reverberation time.

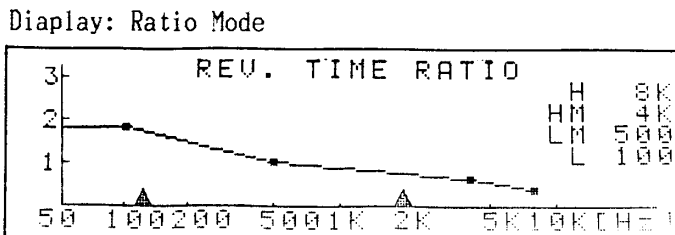

- ② Use the "LOW" selector to alter the low reverberation time band. The LCD will change according to the setting of the selector.
- ③ Use the "MID-HI" selector to alter the mid-high reverberation time band. The LCD will change according to the setting of the selector.
- ④ Use the "HIGH" selector to alter the high reverberation time band. The LCD will change according to the setting of the selector.

15. ADJUSTMENT OF REVERBERATION DELAY TIME (DELAY 2)

- ① Press the "W/F" display key. The LCD will show the "W/F" display, which shows the relationship between the reverberation delay time and the entire composition of the output sound.

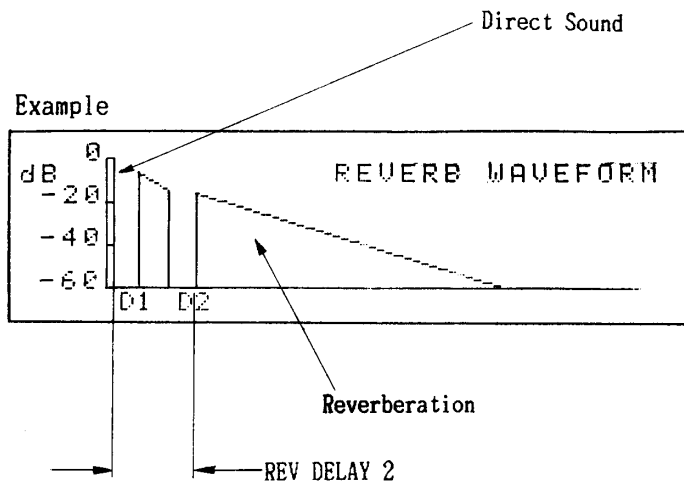

- ② Press the "D2" function key.
- ③ Use the ten-key numerical pad to specify the reverberation delay time value. The value will blink on the "REV. DELAY 2" display. At this time, you may use the "UP" and "DOWN" keys to alter the data. If these keys are used, there is no need for the next step (4).
- ④ Press the "ENTER" key. The "REV. DELAY 2" display will stop blinking, the displayed data will be set, and the LCD graphical display of the reverberation delay time value will change accordingly.

16. MIXING THE DIRECT SOUND, EARLY REFLECTION AND REVERBERATION OUTPUT

- ① Press the "W/F" display key.
- ② Press the "ON" key for the desired output. The LED of the key will light up, and the sound is output.
- ③ Use the output level controls for each of the three sounds to adjust its output. When these controls are being used, the display will change accordingly.

17. OUTPUT LEVEL ADJUSTMENT

- ① Press the level meter "IN/OUT" key to light up the "OUT" LED. This way, you will be able to see the output level on the meter.
- ② Press the "ON" key for the "MASTER" level control, this will light up the LED in the center of the key, and the output of the mixed sounds will be fed to the output terminal.
- ③ Use the "MASTER" output level control to adjust the output level. (Normally MASTER level should be at maximum.)

18. WRITING IN THE REMOTE CONTROL MEMORY

RAM memories 31 to 90 are user-programmable.

- ① Press the "M" memory key.
- ② Use the ten-key numerical pad to specify the number of the memory. This number will blink on the "MEMORY" display.
- ③ Press the "STR" memory key. The specified data will be written into the memory.

19. CHANGING PRE-SET MEMORY DATA

See SECTION IV for information about the "PRESET" group of keys. When the unit leaves the factory, the "PRESET" keys are already set with the data from ROM memories 1 to 8. With the following operation, the data for any of these keys can be changed at will. Note that the data which is set for a "PRESET" key must already have been set in one of the user programmable memories (see the previous explanation), or in one of the memories of the ROM.

- ① Press the "M" memory key.
- ② Use the ten-key numerical pad to specify the number of the memory (1 to 90) which holds the data to be pre-set. This memory number will blink on the "MEMORY" display.
- ③ Press one of the "PRESET" keys (1 to 8).
- ④ Press the "STR" memory key. The memory display will stop blinking, and the data will have been copied into the pre-set key memory.

Note: The "PRESET" keys recall data set in the RAM, they are not a separate memory. If the RAM memory number data is changed, the "PRESET" key will recall the changed data. So remember to keep track of what data you wish the "PRESET" key to recall, and don't change it by mistake.

20. DATA MOVING (RAM Back up)

The remote control can be used to store 9 different sets of data in a RAM (numbers 91 to 99). This data can then be transferred to another REV-1 unit by disconnecting the remote control unit, and connecting it to that unit.

- ① See page 25 for the three steps needed to read data from a memory.
- ② Use the ten-key numerical pad to specify the memory to be used to hold the data, (91 to 99). The "MEMORY" display will blink with the specified memory number.
- ③ Press the "STR" memory key, and the data will be stored in the memory, and the display will stop blinking.

REMOTE CONTROL DISPLAYS

The LCD of the remote control unit (RCR-1) makes it easy to experiment with the sound effects that reverberation can produce. When setting data with the remote control unit, you can take advantage of the 8 display modes below:

KEY	MEANING
① W / F	WAVE FORM
② F / C	FILTER & CROSSOVER
③ R / T	REV. TIME
④ RATIO	REV. TIME RATIO
⑤ E / R	EARLY REFLECTION MODE
⑥ REV	REVERB MODE
⑦ P / S	PRESET TITLE
⑧ M	MEMORY TITLE

(1) W / F

Press this key, and a graphic representation of the composition of the sound output is displayed, which allows you to check the following:

- ① The relationship between direct sound, early reflection, and reverberation levels.
- ② The delay time status for early reflections and reverberation with respect to the direct sound.
- ③ Early Reflection time (t) and Reverberation time (t'). When the latter (t') is over 5 seconds, there is no change.
- ④ The attenuation of early reflections due to the "LIVENESS" setting.

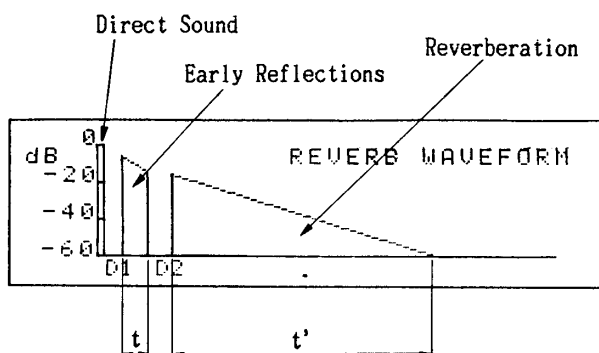

(2) F / C

Press this key, and the following can be checked on the LCD:

- ① The HPF and LPF frequencies.
- ② The LOW/MID-LOW, and MID-LOW/MID-HIGH crossover frequencies.

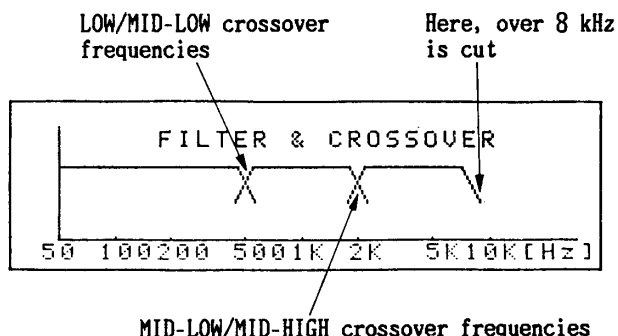

(3) R / T

Press this key, and the LCD will display in graph form, the reverberation time for all 4 bands: LOW, MID-LOW, MID-HIGH, and HIGH. In the upper right hand corner, the central frequency for each band and the reverberation time value is displayed.

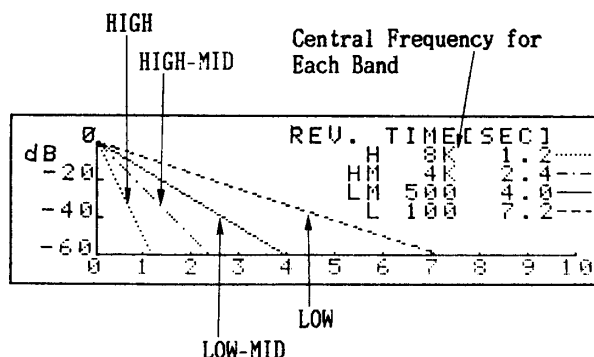

- * When the reverberation time value is changed, the standard frequency band is the MID-LOW band. All other three are changed in relation to it.
- * When the MID-HIGH band is changed, the HIGH band is also affected.
- * When reverberation time is more than 10 seconds, the unit of the axes of the graph change.

[4] RATIO

Press this key, and you will be able to check the following:

- ① Reverberation time ratio of the 4 frequency bands, with the MID-LOW band as 1.
- ② Simplified reverberation time characteristics.
- ③ Crossover Frequencies (marked ▲).
- ④ The center frequency of each band (marked ■).

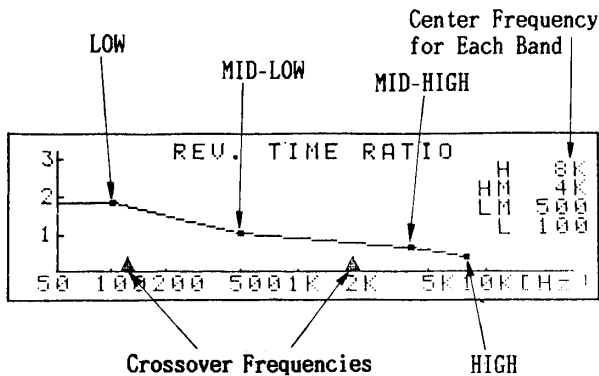

* When the MID-HIGH band is changed, the HIGH band is also affected.

[5] E / R

Press this key, and you will be able to check the following:

- ① Early Refraction Composition
 - Delay time due to ROOM SIZE setting
 - Number of early reflections due to E/R NUMBER setting
 - Attenuation due to LIVENESS setting
- ② Room size change
- ③ E/R mode under selection

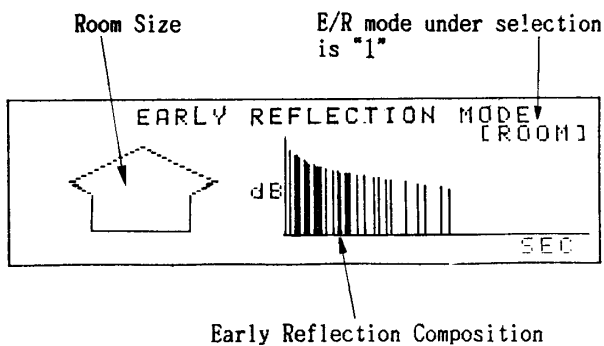

[6] REV

Press this key, and the LCD will show a graphical display of reverberation sound density.

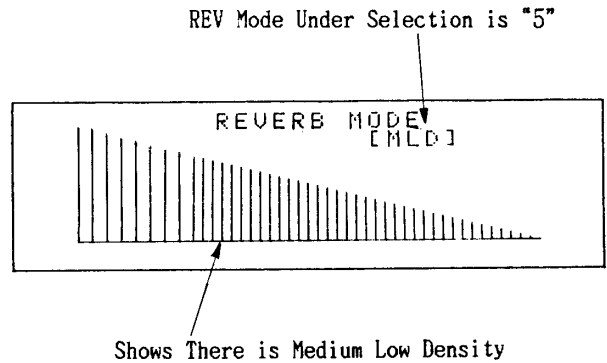

[7] P / S

Press this key once, and the LCD will show the memory numbers and the titles for the data which has been pre-set in keys 1 to 4. Press again, and it will show the titles for keys 5 to 8.

PRESET TITLE 1-4	
1 - M 1	- LARGE HALL
2 - M 2	- MIDDLE HALL
3 - M 3	- SMALL HALL
4 - M 4	- VOC. PLATE A

[8] M

Press this key to see the titles for all the data in the memory (ROM only). The titles are shown in three groups which change with each press of the key: 1 to 10; 11 to 20; and 21 to 30.

MEMORY TITLE 1-10			
1	LARGE HALL	6	PERC. A
2	MIDDLE HALL	7	PERC. B
3	SMALL HALL	8	STRINGS
4	VOC. PLATE A	9	STRINGS
5	VOC. PLATE B	10	ELEC. BASS

* For memory numbers 19 to 28, after this key is pressed, and the titles are shown, the LCD display will not change even when the display mode is changed by pressing another display key.

REV-1 UNIT LAYOUT

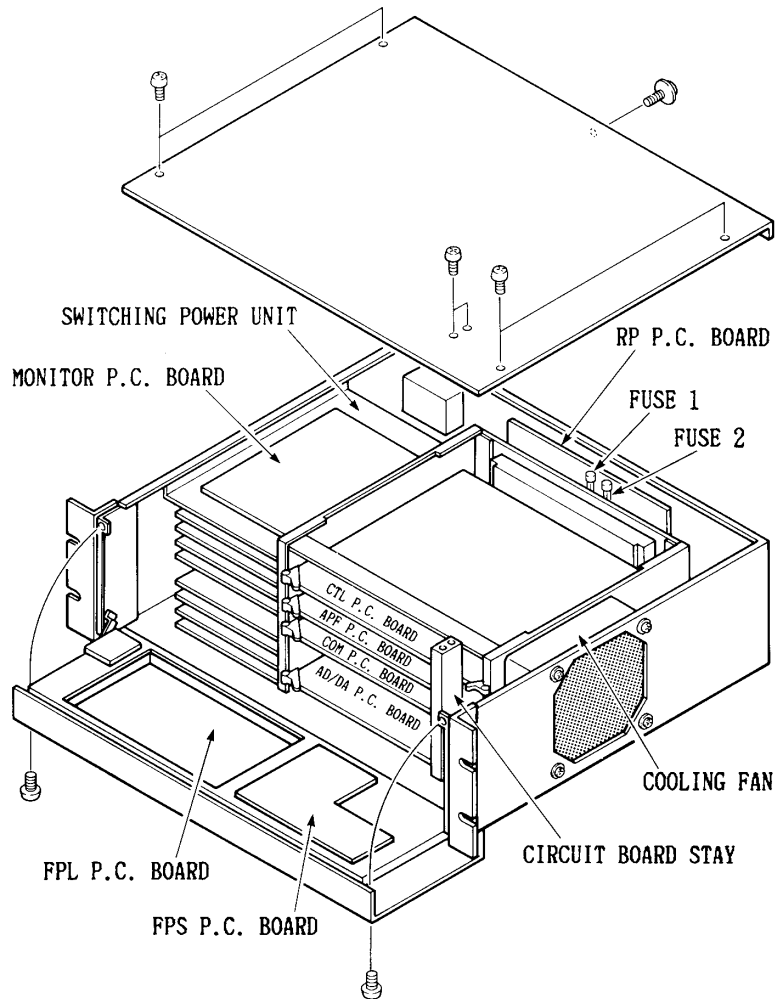

RCR-1 DISASSEMBLY

★Remote Control Panel Removal

Unscrew the 6 screws shown in the diagram, and remove the panel.

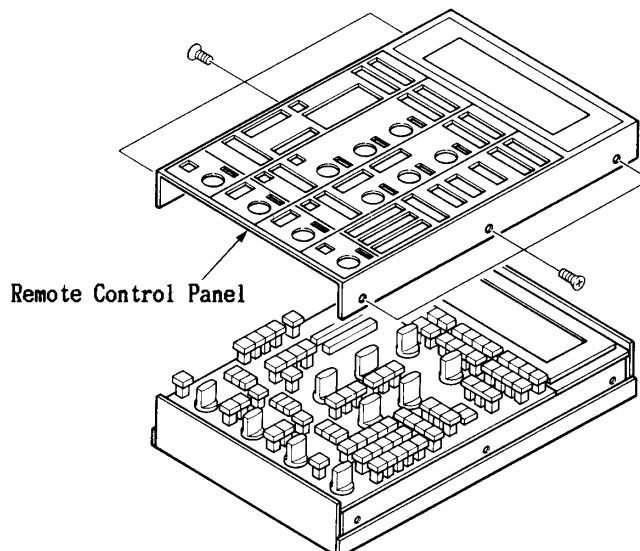

DIAGNOSTICS PROGRAMS

In the main unit of the REV-1, self-diagnostic programs will automatically check the micro-computer portion, interfaces, and other parts of the control P.C. Board. If any abnormality is detected, the following may occur:

1. No number will be displayed on the displays (REVERB TIME, E/R DELAY 1, MEMORY).
2. "0" will be displayed on all displays.
3. No entry will be accepted from keys or buttons. If this happens, run the following self-diagnostic programs:

● Enter Self-Diagnostic Mode

All self-diagnostic programs will be run with the front panel controls. Hold the "R/T" and the "MEMORY" buttons down at the same time while you turn on the power. This will put the unit in the self-diagnostic mode. At this time, the control P.C. Board will automatically be checked. The following display means that there is nothing wrong with the control P.C. Board:

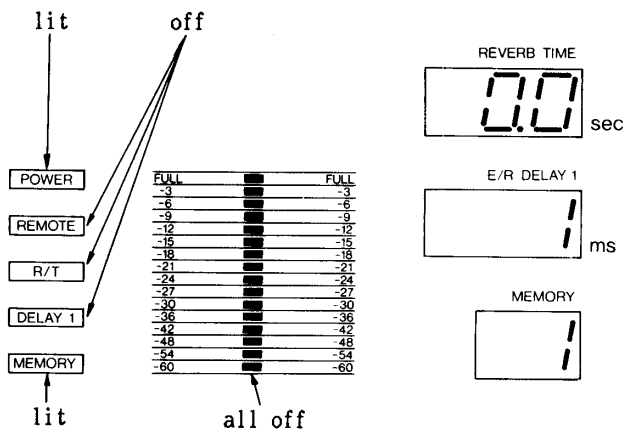

If the above is not displayed, something is wrong with the control P.C. Board.

When the control sheet has been found to be functioning normally, perform the following procedures :

○ Check the Digital Arithmetic Operations of the APF and COM P.C. Boards

Press the following buttons in the order shown:

MEMORY - 1 - 0 - RECALL

If the APF and COM P.C. Boards are functioning normally, you will see the following display:

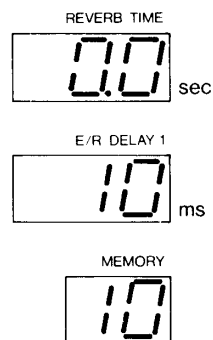

If a number from between 10.0 to 34.1 is displayed on the "REVERB TIME" display, something is wrong with the APF P.C. Board. If a number from between 40.0 to 54.1 is displayed, there is something wrong with the COM P.C. Board.

○ Check the AD/DA Circuit of the AD/DA P.C. Board

Connect any music program to the input connector of the rear panel. Press the following buttons in the order shown:

MEMORY - 2 - 0 - RECALL

The AD/DA portions will be directly connected, bypassing the digital arithmetic portion. The peak level meter, etc., will function as normal.

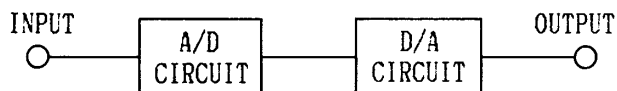

If no audible problems are detected, such as distortion, or noise, the AD/DA P.C. Board is functioning normally. While this diagnostic program is running, you will see the following display:

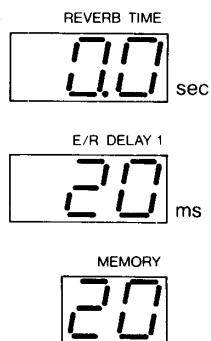

○ Check All Operation

Connect any music program to the input connector of the rear panel. Press the following buttons in the order shown:

MEMORY - 3 - 0 - RECALL

The signal will pass through the A/D circuit, digital arithmetic operation circuit, and then the D/A circuit in that order. The result of the digital arithmetic operation should equal 1, and only direct sound should be output. If no audible problems are detected, such as distortion, or noise, all P.C. Boards can be considered to be functioning normally. While this diagnostic program is running, you will see the following display:

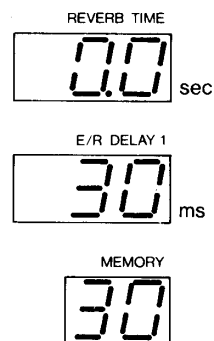

○ Return to Normal Operation Mode

Turn the power switch off. When the power switch is turned on again, the unit will have returned to the normal operation mode.

MAINTENANCE

The REV-1/RCR-1 do have parts that will require replacement after extended periods of use. See your YAMAHA representative for the proper parts and maintenance advice.

RAM Back Up Batteries

The REV-1/RCR-1 use Ni-Cd batteries in their CTL and RMC P.C. Boards. The batteries have a life of three years, but it is recommended that they be changed before that period is up.

KEYS FOR SPECIAL MEMORIES

The data in the memory numbers shown on this page cannot be varied with all of the keys on the remote control unit. The keys which are effective for such memories are shown in the following four diagrams.

- 21. STEREO FLANGE
- 22. STEREO PHASING
- 23. TREMOLO
- 24. CHORUS A
- 25. CHORUS B

20. STEREO ECHO

19. DELAY

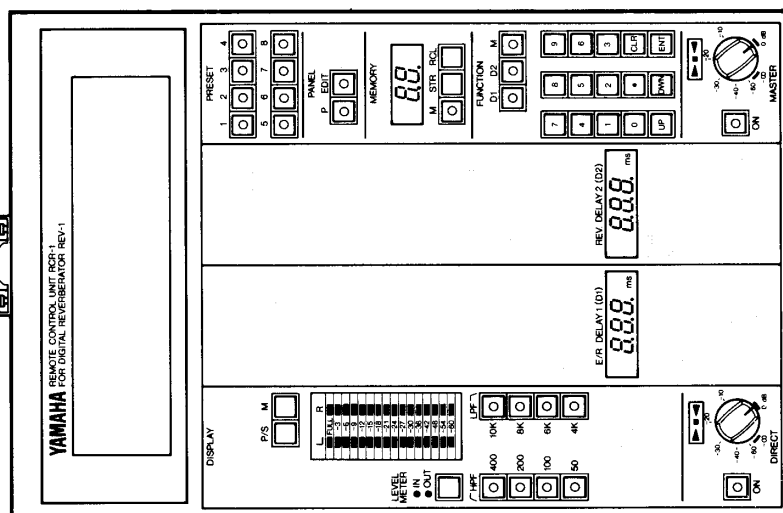
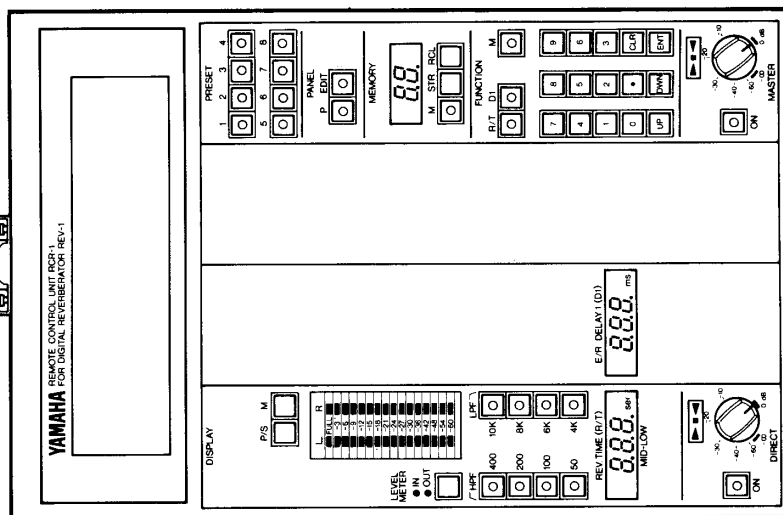
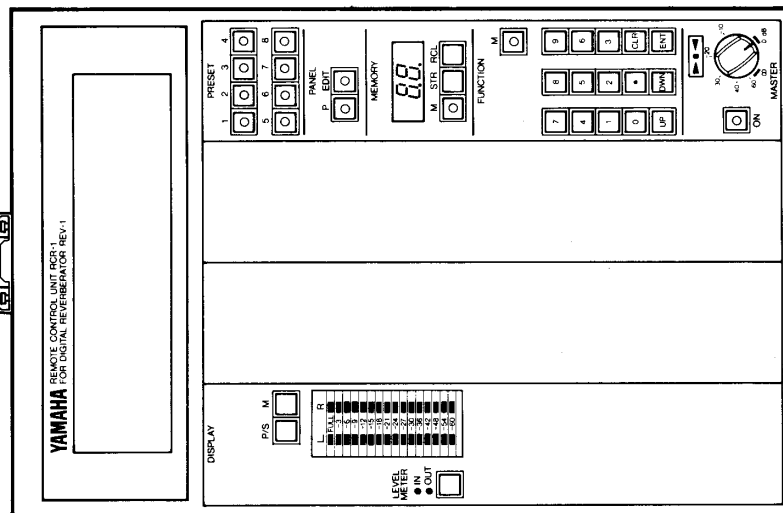

- 26. CONSTANT DENSITY A
- 27. CONSTANT DENSITY B
- 28. CONSTANT DENSITY C

CONSTANT DENSITY

Constant density is the reverberation which from the repetition of the early reflections, and is mainly controlled by the E/R section parameters.

The following is the relationship between DELAY 1 (D1), and DELAY 2.

Given that $D2 \geq D1$

When $t \geq D2 - D1 \geq 0$

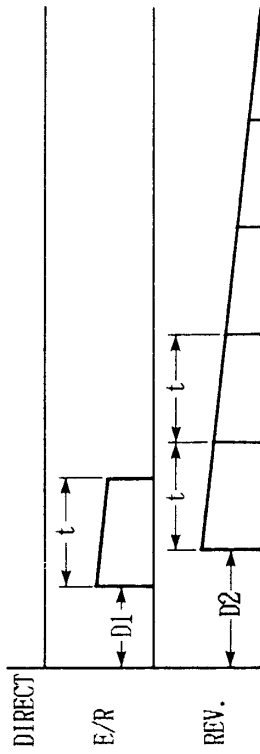

When $t < D2 - D1$

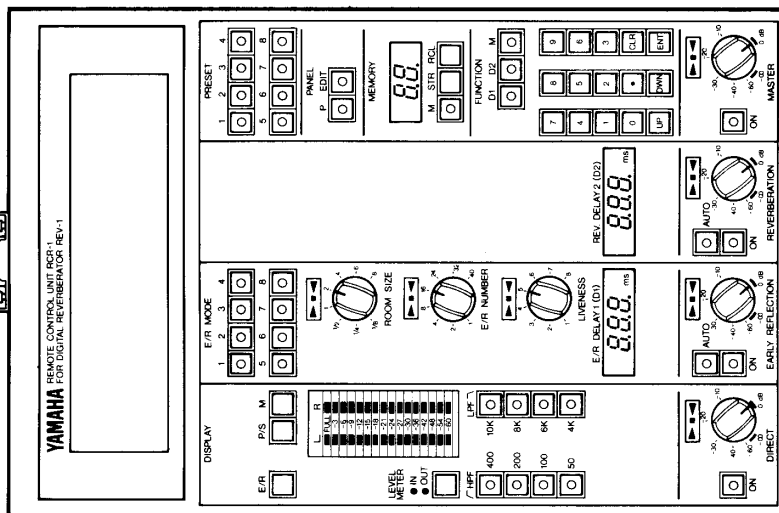
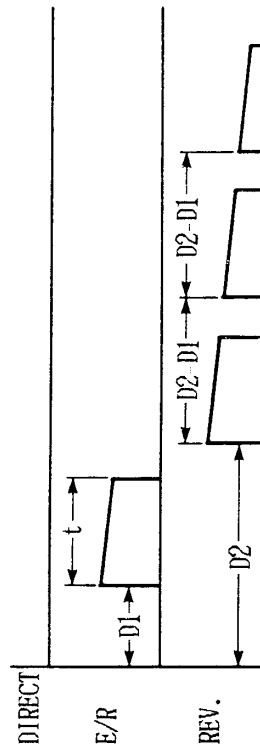

APPENDIX

① ECHO TIME PATTERN FOR EARLY REFLECTIONS

ROOM SIZE : 4

E/R NUMBER : 40

LIVENESS : 5

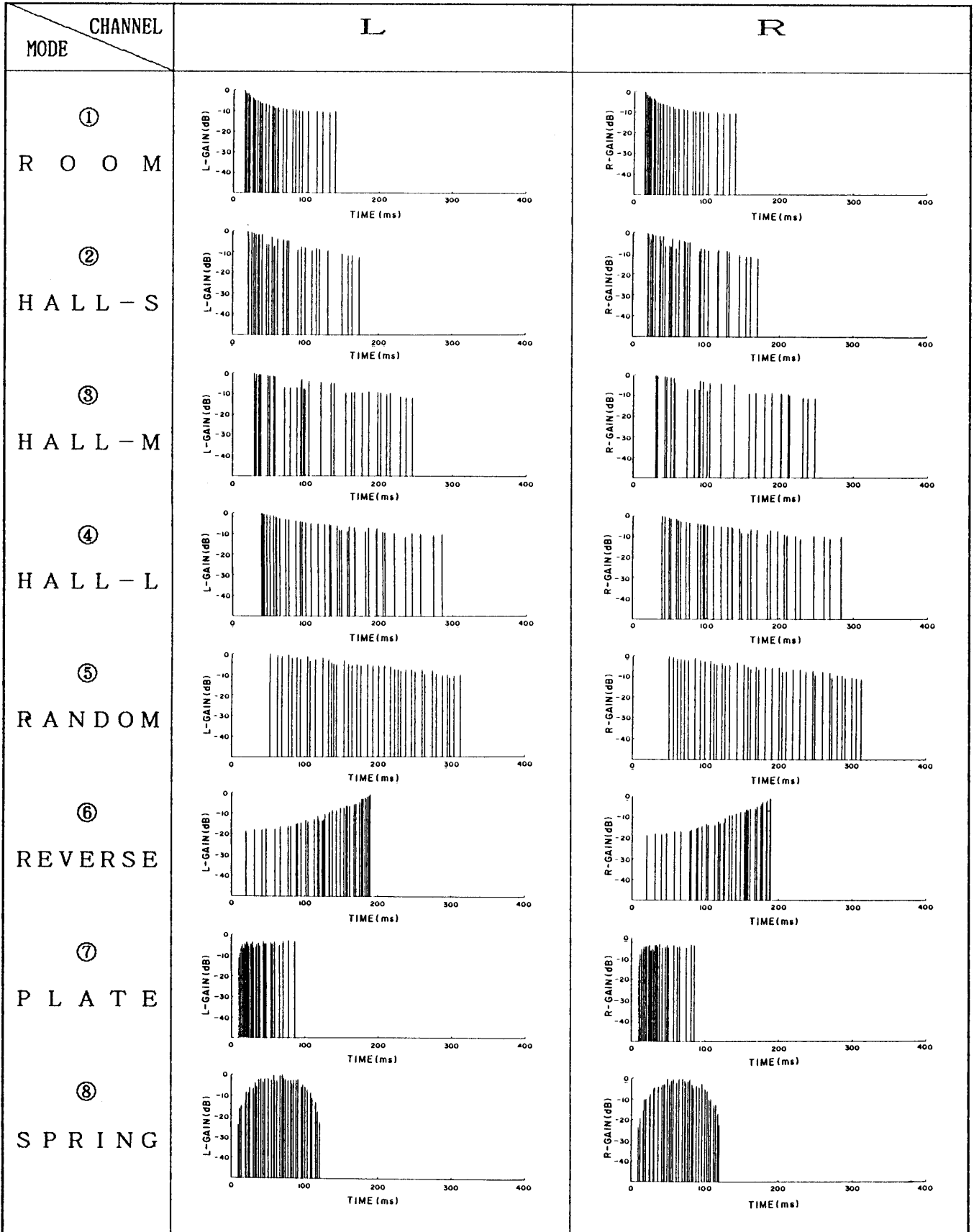

② RELATION BETWEEN ROOM SIZE E/R SETTING AND ACTUAL ROOMS (Left to Right)

LIVENESS : 5

ROOMS	BOX	Minicar	Shed	Apartment Room	Small Meeting Room	Large Meeting Room	Small Mid-Sized Hall	Large Hall	Auditorium	Astrodome
Average Travel (m)	0.24	0.52	1.11	2.40	5.17	11.1	24.0	51.7	111	
Perimeter of Room when Made Cubical (m)	0.46	1	2.15	4.64	10	21.5	46.4	100	215	
Room Volume (m ³)	0.1	1	10	10 ²	10 ³	10 ⁴	10 ⁵	10 ⁶	10 ⁷	
Mode Name and Number										
① ROOM		$\frac{1}{8}$	$\frac{1}{4}$	$\frac{1}{2}$	1	2	4	6	8	
② HALL-S		$\frac{1}{8}$	$\frac{1}{4}$	$\frac{1}{2}$	1	2	4	6	8	
③ HALL-M		$\frac{1}{8}$	$\frac{1}{4}$	$\frac{1}{2}$	1	2	4	6	8	
④ HALL-L		$\frac{1}{8}$	$\frac{1}{4}$	$\frac{1}{2}$	1	2	4	6	8	
⑤ RANDOM		$\frac{1}{8}$	$\frac{1}{4}$	$\frac{1}{2}$	1	2	4	6	8	
⑥ REVERSE		$\frac{1}{8}$	$\frac{1}{4}$	$\frac{1}{2}$	1	2	4	6	8	
⑦ PLATE		$\frac{1}{8}$	$\frac{1}{4}$	$\frac{1}{2}$	1	2	4	6	8	
⑧ SPRING		$\frac{1}{8}$	$\frac{1}{4}$	$\frac{1}{2}$	1	2	4	6	8	

③ AVERAGE REFLECTION DENSITY FOR EACH REV. MODE

Mode Name and Number	Density
① SHD (Super High Density)	About 20,000/sec.
② HD/HID (High Density / High Initial Diffusion)	About 15,000/sec.
③ HD/LID (High Density / Low Initial Diffusion)	About 10,000/sec.
④ MD (Medium Density)	About 2,500/sec.
⑤ MLD (Medium Low Density)	About 1,200/sec.
⑥ LD (Low Density)	About 250/sec.
⑦ SLD (Super Low Density)	About 50/sec.
⑧ ESD (Equally Spaced Diffusion)	About 25/sec.

FCC CERTIFICATION (USA)

This equipment generates and uses radio frequency energy and if not installed and used properly, that is, in strict accordance with the manufacturer's instructions, may cause interference to radio and television reception. It has been type tested and found to comply with the limits for a Class B computing device in accordance with the specifications in Subpart J of Part 15 of FCC Rules, which are designed to provide reasonable protection against such interference in a residential installation. However, there is no guarantee that interference will not occur in a particular installation. If this equipment does cause interference to radio or television reception, which can be determined by turning the equipment off and on, the user is encouraged to try to correct the interference by one or more of the following measures:

Reorient the receiving antenna.

Relocate the computer with respect to the receiver.

Move the computer away from the receiver.

Plug the computer into a different outlet so that computer and receiver are on different branch circuits.

If necessary, the user should consult the dealer or an experienced radio/television technician for additional suggestions. The user may find the following booklet prepared by the Federal Communications Commission helpful:

"How to identify and Resolve Radio-TV interference Problems".

This booklet is available from the U.S. Government Printing Office, Washington, DC 20402, Stock No. 004-000-00345-4.

SINCE 1887



YAMAHA

NIPPON GAKKI CO., LTD. HAMAMATSU, JAPAN